

Attention: To prevent electrical shock, disconnect from power source before installing or servicing. Install in suitable enclosure. Keep free from contaminants.

Achtung: Vor Installations- oder Servicearbeiten Stromversorgung unterbrechen, um Unfälle zu vermeiden. Die Geräte müssen in einem passenden Gehäuse eingebaut und gegen Verschmutzung geschützt werden.

Attenzione: Per prevenire infortuni, togliere tensione prima dell'installazione o manutenzione. Installare in custodia idonea. Tenere lontano da contaminanti.

Attention: Avant le montage et la mise en service, couper l'alimentation secteur afin d'éviter tout accident. Prévoir une mise en coffret ou armoire appropriée. Protéger le produit contre les environnements agressifs.

Atención: Desconectar la alimentación eléctrica antes de realizar el montaje y la puesta en servicio, con el objeto de evitar accidentes. Instalado en una caja o armario apropiado. Proteger el producto de los ambientes agresivos.

...-CF...Z(D) / CS.C(D)
 ...-CFM...Z(D) / CS.C(D)-M
 ...-C09Z(D) / ...-9C(D)
 ...-C12Z(D) / ...-12C(D)
 ...-C16Z(D) / ...-16C(D)

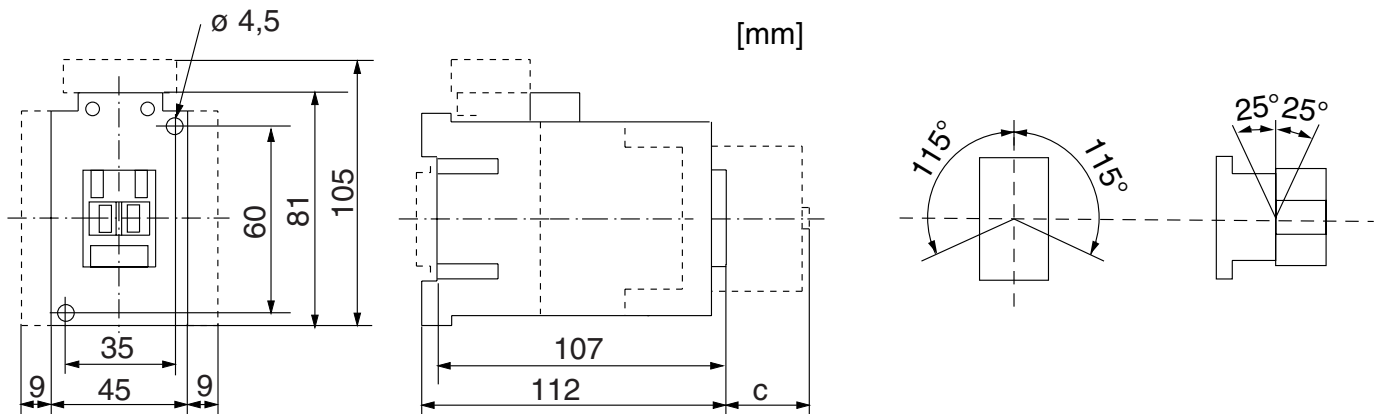







c [mm]	34	53



IEC 60947-1/-4-1/-5-1
 EN 60947-1/-4-1/-5-1
 UL 508; CSA 22.2 Teil 14;

		<p>9 mm</p> <p>2 x 1 ... 4 mm² No. 16 ... 10 AWG</p> <p>Use 75°C Cu wire only</p> <p>2 x 1,5 ... 6 mm² No. 16 ... 10 AWG</p>	<p>1 ... 2,5 Nm 8,9 ... 22 lb-in</p> <p>Pozidriv No. 2</p>
A1		<p>9 mm</p> <p>1 x 1 ... 2,5 mm² 2 x 1 ... 2,5 mm² No. 16 ... 12 AWG</p> <p>Use 75°C Cu wire only</p> <p>1 x 1 ... 4 mm² 2 x 1 ... 4 mm² No. 16 ... 12 AWG</p>	<p>1 ... 1,5 Nm 8,9 ... 13 lb-in</p> <p>No. 3 Pozidriv No. 2</p>

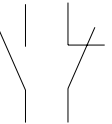
IEC 60947-4-1 EN 60947-4-1 Ue £ 690 V	gG  max.		max. 
	Type 1	Type 2	
 9 12 16	50 A 50 A 50 A	25 A 35 A 35 A	 
IEC 60947-5-1 EN 60947-5-1	gG  max.		
	20 A		

USA/CND

Suitable for use on a circuit capable of delivering not more than 5000 rms symmetrical amperes

Size	Fuse 600 Volts Maximum	Circuit Breaker 480 Volts Maximum
09	35 A	30 A
12	40 A	30 A
16	70 A	50 A

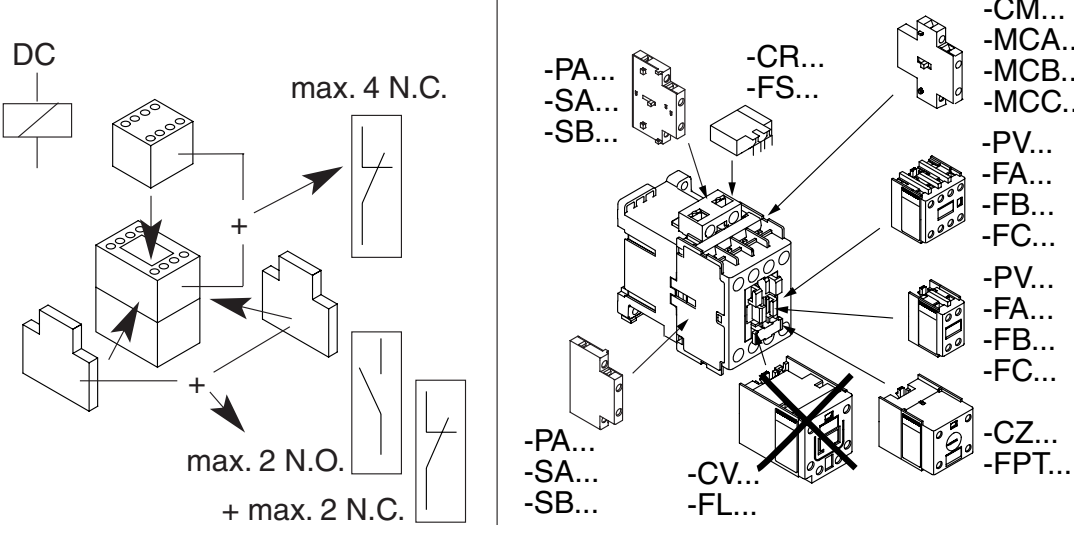
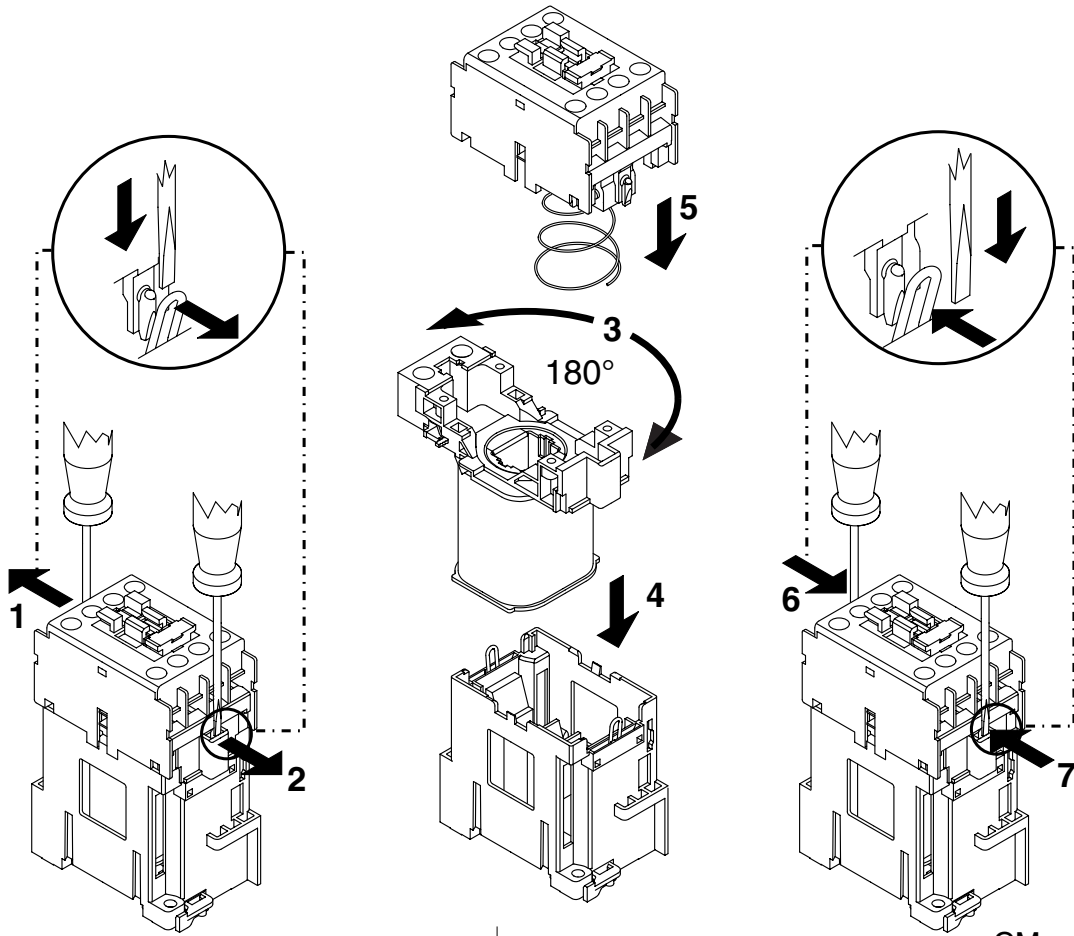

For Starters:
 Use Electronic
 Motor Protection
 Relays
 only (193-E...)
 (CEP7...)