



Attention: To prevent electrical shock, disconnect from power source before installing or servicing. Install in suitable enclosure. Keep free from contaminants.



Achtung: Vor Installations- oder Servicearbeiten Stromversorgung unterbrechen, um Unfälle zu vermeiden. Die Geräte müssen in einem passenden Gehäuse eingebaut und gegen Verschmutzung geschützt werden.



Attention: Avant le montage et la mise en service, couper l'alimentation secteur afin d'éviter tout accident. Prévoir une mise en coffret ou armoire appropriée. Protéger le produit contre les environnements agressifs.



Attenzione: Per prevenire infortuni, togliere tensione prima dell'installazione o manutenzione. Installare in custodia idonea. Tenere lontano da contaminanti.



Atención: Desconectar la alimentación eléctrica antes de realizar el montaje y la puesta en servicio, con el objeto de evitar accidentes. Instalado en una caja o armario apropiado. Proteger el producto de los ambientes agresivos.

...Q7-16 / ...Q-C16

22.247.971-01
Printed in Switzerland
Edition 5









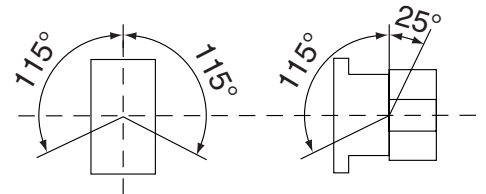
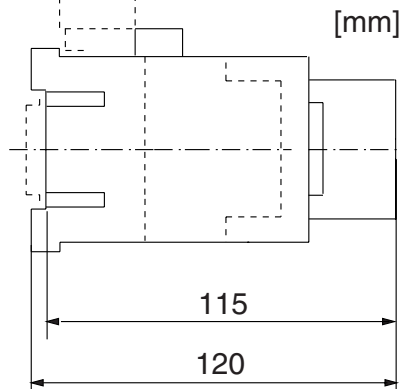
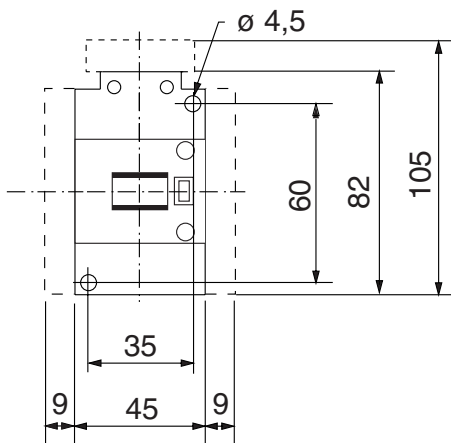



IEC 60947-1/-4-1/-5-1
EN 60947-1/-4-1/-5-1
UL 508

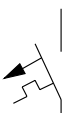

CSA 22.2 part 14

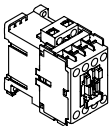

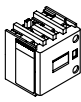
		<p>9 mm</p> <p>2 x 1 ... 2,5 mm² No. 16 ... 12 AWG</p> <p>Use 75°C Cu wire only</p> <p>2 x 1,5 ... 4 mm² No. 16 ... 12 AWG</p>	<p>1 ... 2,5 Nm 8,9 ... 22 lb-in</p> <p>No. 3 Pozidriv No. 2</p>
<p>A1</p> <p>A2</p>		<p>9 mm</p> <p>1 x 1 ... 2,5 mm² 2 x 1 ... 2,5 mm² No. 16 ... 12 AWG</p> <p>Use 75°C Cu wire only</p> <p>1 x 1 ... 4 mm² 2 x 1 ... 4 mm² No. 16 ... 12 AWG</p>	<p>1 ... 1,5 Nm 8,9 ... 13 lb-in</p> <p>No. 3 Pozidriv No. 2</p>

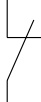
IEC 60947-4-1 EN 60947-4-1 $U_e \leq 690 \text{ V}$	gG  max. Type 1	gG  max. Type 2	Type 2  max.  
 22	50 A	35 A	
IEC 60947-5-1 EN 60947-5-1	gG  max.		
  	20 A		
  	10 A		

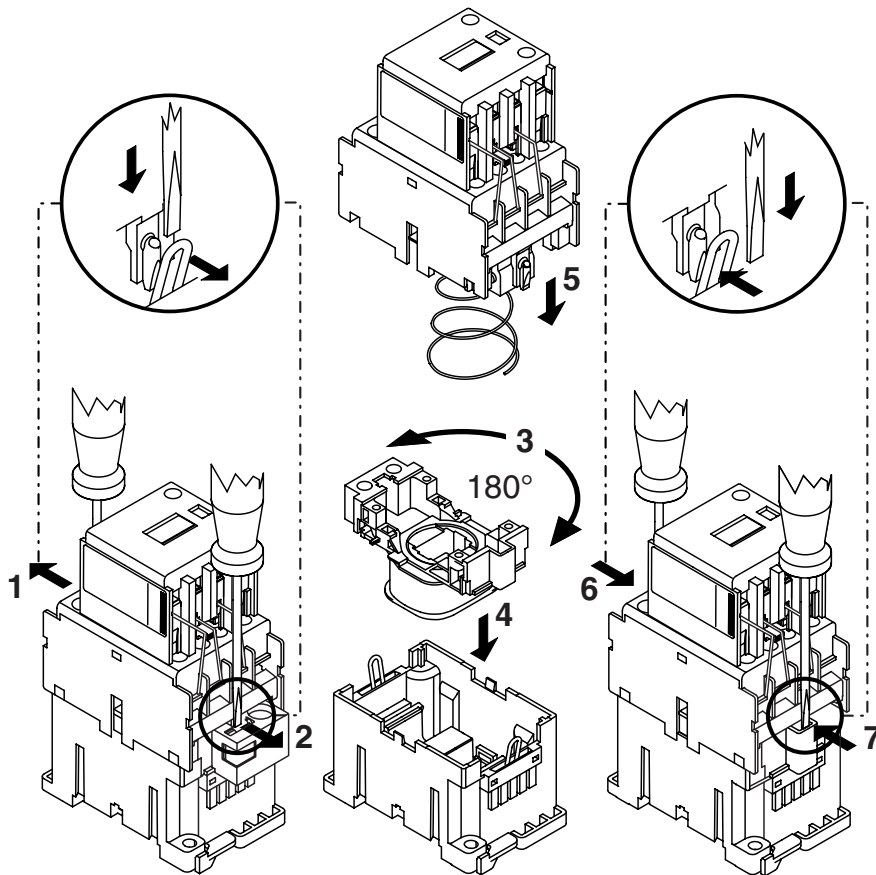

AC

