



Allen-Bradley

***Bulletin 1203
Serial Communications
Module
(Series B)***

***RS232/422/483 (Using DF1 Protocol)
DH485***

(Cat. No. 1203-GD2, -GK2, -GM2)

User Manual

Allen-Bradley Spares

Important User Information

Solid state equipment has operational characteristics differing from those of electromechanical equipment. “Safety Guidelines for the Application, Installation and Maintenance of Solid State Controls” (Publication SGI-1.1) describes some important differences between solid state equipment and hard-wired electromechanical devices. Because of this difference, and also because of the wide variety of uses for solid state equipment, all persons responsible for applying this equipment must satisfy themselves that each intended application of this equipment is acceptable.

In no event will the Allen-Bradley Company be responsible or liable for indirect or consequential damages resulting from the use or application of this equipment.

The examples and diagrams in this manual are included solely for illustrative purposes. Because of the many variables and requirements associated with any particular installation, the Allen-Bradley Company cannot assume responsibility or liability for actual use based on the examples and diagrams.

No patent liability is assumed by Allen-Bradley Company with respect to use of information, circuits, equipment, or software described in this manual.

Reproduction of the contents of this manual, in whole or in part, without written permission of the Allen-Bradley Company is prohibited.

Throughout this manual we use notes to make you aware of safety considerations.



ATTENTION: Identifies information about practices or circumstances that can lead to personal injury or death, property damage, or economic loss.

Attentions help you:

- identify a hazard
- avoid the hazard
- recognize the consequences

Important: Identifies information that is especially important for successful application and understanding of the product.

Table of Contents

Preface

Who Should Use this Manual	P-1
Purpose of this Manual	P-1
Contents of this Manual	P-2
Related Documentation	P-2
Terms and Abbreviations	P-3
Conventions	P-3
Firmware Support	P-3
Safety Precautions	P-3
Serial Device Compatibility	P-4
Allen-Bradley Support	P-4
Local Product Support	P-4
Technical Product Assistance	P-4

Product Description

Chapter 1

Chapter Objectives	1-1
Module Description	1-1
SCANport Device Compatibility	1-2
Configuration Switches	1-6

Installation

Chapter 2

Chapter Objectives	2-1
Setting Module Configuration Switches	2-1
Switch SW1	2-3
DF1/DH-485 Address Selection	2-4
DF1 Address Selection	2-5
Switch SW2	2-6
Switch SW3	2-8
Mounting the Serial Communications Module	2-10
Enclosed Style Serial Communications Module Dimensions	2-12
Connecting Cables	2-13
1746-BAS Module Serial Connections	2-13
IBM PC Compatible Serial Connections	2-14
1747-AIC Link Coupler Serial Connections	2-14
PLC5 Channel 0 Serial Connections	2-15
SCANport Link Connection	2-16
1305 Drive	2-16
1336 PLUS and 1336 FORCE™	2-17
1394	2-17
SMP 3	2-17
Power Supply Connections	2-18

Allen-Bradley Spares

SCANport Datalink Operation	Chapter 3	
	Chapter Objectives	3-1
	SCANport Datalinks	3-1
Configuring and Interfacing	Chapter 4	
	Chapter Objectives	4-1
	Serial Communications Module Data Table Structure	4-1
	Supported PCCC Command List	4-2
	Data Table Structure	4-3
	Configuration Examples	4-9
	DF1 Messaging with a PLC-5/80 Example	4-9
	DF1 Messaging with a 1746-BAS Module Example	4-11
	DH-485 Messaging with a SLC5/03 Interface	4-13
	Block Transfer Emulation Instructions	Chapter 5
Chapter Objectives		5-1
Block Transfer Status Word		5-1
Scattered Parameter Value Read		5-2
Scattered Parameter Value Write		5-4
Product ID Number Read		5-6
Parameter Read Full		5-8
Parameter Value Read		5-11
Parameter Value Write		5-12
EE Memory Functions		5-13
Fault Clear/Reset		5-15
Fault Queue Entry Read Full		5-16
Fault Queue Size		5-18
Trip Fault Queue Number		5-19
Troubleshooting		Chapter 6
	Chapter Objectives	6-1
	LED Locations	6-1
	LED Troubleshooting Table	6-2
Specifications	Chapter 7	
	Chapter Objectives	7-1
	Product Specifications	7-1
	Module Compatibility	7-1

Preface

Read this preface to familiarize yourself with the rest of the manual. This preface covers the following topics:

- who should use this manual
- the purpose of this manual
- terms and abbreviations
- conventions used in this manual
- safety precautions
- Allen–Bradley support

Who Should Use this Manual

Use this manual if you are responsible for setting up and servicing the Serial Communications Module. You must have previous experience with and a basic understanding of communications terminology, configuration procedures, required equipment, and safety precautions.

To use this Serial Communications Module efficiently, you must be able to program and operate serial communications devices, as well as have a basic understanding of the parameter settings and functions of the device to which you are communicating.

Purpose of this Manual

This manual is an installation and user guide for the Serial Communications Module. The Serial Communications Module is available for products that include the SCANport™ communications port.

This manual provides you with the following:

- an overview of the Serial Communications Module
- the procedures you need to install, configure, and troubleshoot the Serial Communications Module

For information on specific features of Allen–Bradley products mentioned within this manual, refer to the user manual for that product.

Important: You should read this manual in its entirety before installing, operating, servicing, or initializing the Serial Communications Module.

Allen-Bradley Spares

Contents of this Manual

Chapter	Title	Contents
	Preface	Describes the purpose, background, and scope of this manual. Also specifies the audience for whom this manual is intended.
1	Product Description	Explains the Serial Communications Module's features, configuration, and diagnostics.
2	Installation	Provides procedures for mounting, connecting power, configuring switches, cabling, and connecting hardware.
3	SCANport Datalink Operation	Provides information for configuring SCANport device datalinks and datalink operation.
4	Configuring and Interfacing	Provides information about addressing, information transfer, and sample programs.
5	Block Transfer Emulation Instructions	Provides information for using the block transfer emulation instructions.
6	Troubleshooting	Explains how to interpret and correct problems with your Serial Communications Module.
7	Specifications	Provides environmental, electrical, and communications specifications.

Related Documentation

The following documents contain additional information concerning Allen-Bradley SLC™ and PLC products. To obtain a copy, contact your local Allen-Bradley office or distributor.

For	Read This Document	Document Number
Information about the DH-485 network	Data Highway/Data Highway Plus™/DH-485 Communication Protocol and Command Set	1770-6.5.16
Additional information about setting up the DH-485 network on your SLC 500™	SLC 500™ Modular Hardware Style	1747-NI002, Series A
A complete listing of current Allen-Bradley documentation, including ordering instructions. Also indicates whether the documents are available on CD-ROM or in multi-languages.	Allen-Bradley Publication Index	SD499
A glossary of industrial automation terms and abbreviations	Allen-Bradley Industrial Automation Glossary	AG-7.1
Information about the MSG block	Instruction Set Reference	6200-6.4.11
Information about configuring the PLC-5 channel 0 hardware	Hardware Installation Manual	1785-6.6.1
Information about configuring the PLC-5 channel 0 driver	Software Configuration and Maintenance	6200-6.4.6

Terms and Abbreviations

The following terms and abbreviations are specific to this product. For a complete listing of Allen–Bradley terminology, refer to the *Allen–Bradley Industrial Automation Glossary*, Publication Number ICCG–7.1. In this manual, we refer to the:

- Variable Frequency AC Drive (Bulletin 1305, 1336 FORCE, 1336 PLUS™, 1395, 1557, SMC, SMC Plus, or SMC dialog) as the *drive* or *SCANport device*.
- Programmable Logic Controller as the *Programmable Controller* or *PLC*.
- Earth Ground as *GND*.

Conventions

The following conventions are used throughout this manual:

- Bulleted lists such as this one provide information, not procedural steps.
- Numbered lists provide sequential steps or hierarchical information.
- *Italic* type is used for emphasis.
- Text in this font indicates words or phrases you should type.

Firmware Support

This manual supports communications module firmware versions 2.xx (the “xx” designator may vary). Features that work with specific firmware versions will be denoted as such.

Safety Precautions



ATTENTION: Only personnel familiar with SCANport devices and associated machinery should plan or implement the installation, start-up, configuration, and subsequent maintenance of the serial communications module. Failure to comply may result in personal injury and/or equipment damage.



ATTENTION: This module contains Electrostatic Discharge (ESD) sensitive parts and assemblies. Static control precautions are required when installing, testing, servicing, or repairing this assembly. Component damage may result if ESD control procedures are not followed. If you are not familiar with static control procedures, refer to Allen–Bradley Publication 8000–4.5.2, *Guarding Against Electrostatic Damage* or any other applicable ESD protection handbook.

Serial Device Compatibility

This Serial Communications Module is intended for use with devices that communicate via the following protocols:

Hardware Standard	Communications Protocol
RS-232	DF1
RS-422	DF1
RS-485	DF1
DH-485	DH-485

Allen-Bradley Support

Allen-Bradley offers support services worldwide, with over 75 Sales/Support Offices, 512 authorized Distributors, and 260 authorized Systems Integrators located throughout the United States alone, plus Allen-Bradley representatives in every major country in the world.

Local Product Support

Contact your local Allen-Bradley representative for:

- sales and order support
- product technical training
- warranty support
- support service agreements

Technical Product Assistance

If you need to contact Allen-Bradley for technical assistance, please review the information in the *Troubleshooting* chapter first. Then call your local Allen-Bradley representative.

Product Description

Chapter Objectives

In this chapter, you will read about:

- Serial Communications Module features
- the location of configuration switches

Module Description

The Serial Communications Module is an optional interface device designed to provide a direct digital link between serial communications devices and any device that uses SCANport. The current list of products that use SCANport includes: 1305, 1336 PLUS, 1336 FORCE, 1394, SMP3 controllers, and 1557 medium voltage drives. The module connects to these products via SCANport.

The Serial Communications Module is available in both Open style (Figure 1.1) and Enclosed (Figure 1.2) type configurations. The Open style module mounts inside certain drives, depending on drive size. The Enclosed module mounts independently and can be used with any SCANport device. The following table provides more information about the Open and Enclosed styles.

Designation	Enclosure	Power Supply Source	Used With
Open Style	Open PC Board	Supplied by the drive	1336 PLUS* 1336 FORCE** 1394***
Enclosed	IP30	24V DC separately supplied or 120/240V AC separately supplied	1305 1336 PLUS 1336 FORCE 1394 SMP3 Other SCANport products

* 7.5HP and higher sizes only, excluding the AQF and BRF catalog number drives

** 7.5HP and higher sizes with Standard Adapter board only

*** analog 1394 only

SCANport Device Compatibility

The SCANport Serial Communications Module is compatible with the following Allen-Bradley devices:

Device	Firmware Revision
1336 PLUS	All
1336 FORCE	All
1305 Micro Drive	2.0 or newer
SMC	
SMP	
1394	
1557	

Figure 1.1
Open Style Communications Module

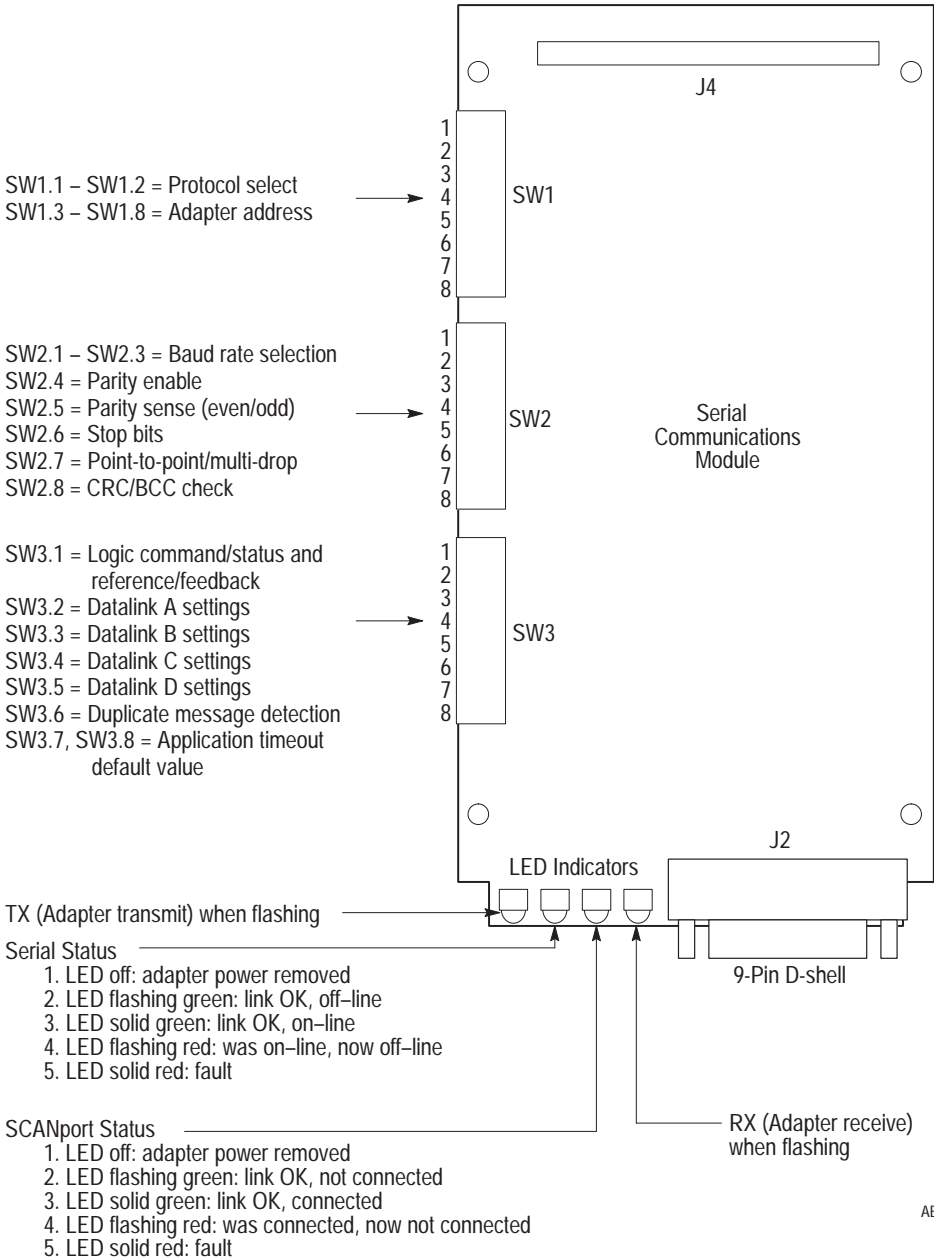

AB0394C

Figure 1.2
Enclosed Style Serial-to-SCANport Communications Module

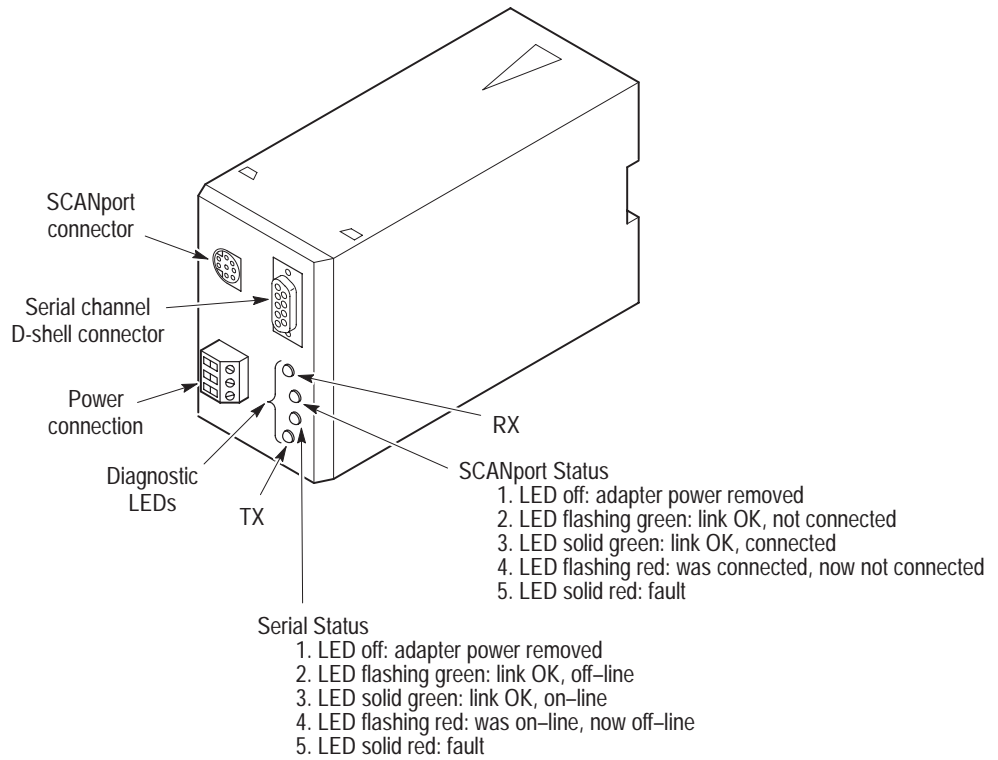

- | | | |
|---|---|---|
| <p>Switch SW3</p> <ul style="list-style-type: none"> - Logic command/status and reference/feedback - Datalink A, B, C, D settings - Application timeout Default value - Duplicate message detection | <p>Switch SW2</p> <ul style="list-style-type: none"> - Baud rate selection - Parity enable - Parity sense (even/odd) - Stop bits - Point-to-point/multi-drop - CRC/BCC check | <p>Switch SW1</p> <ul style="list-style-type: none"> - Protocol select - Adapter address |
|---|---|---|

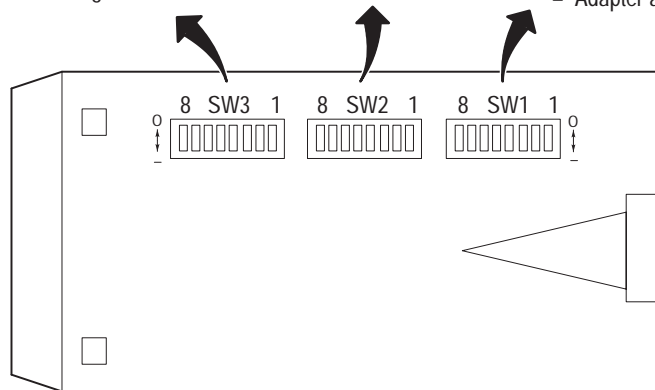

Bottom View

AB0415B

Figure 1.3
Typical Serial Communications/SCANport Device Interconnect

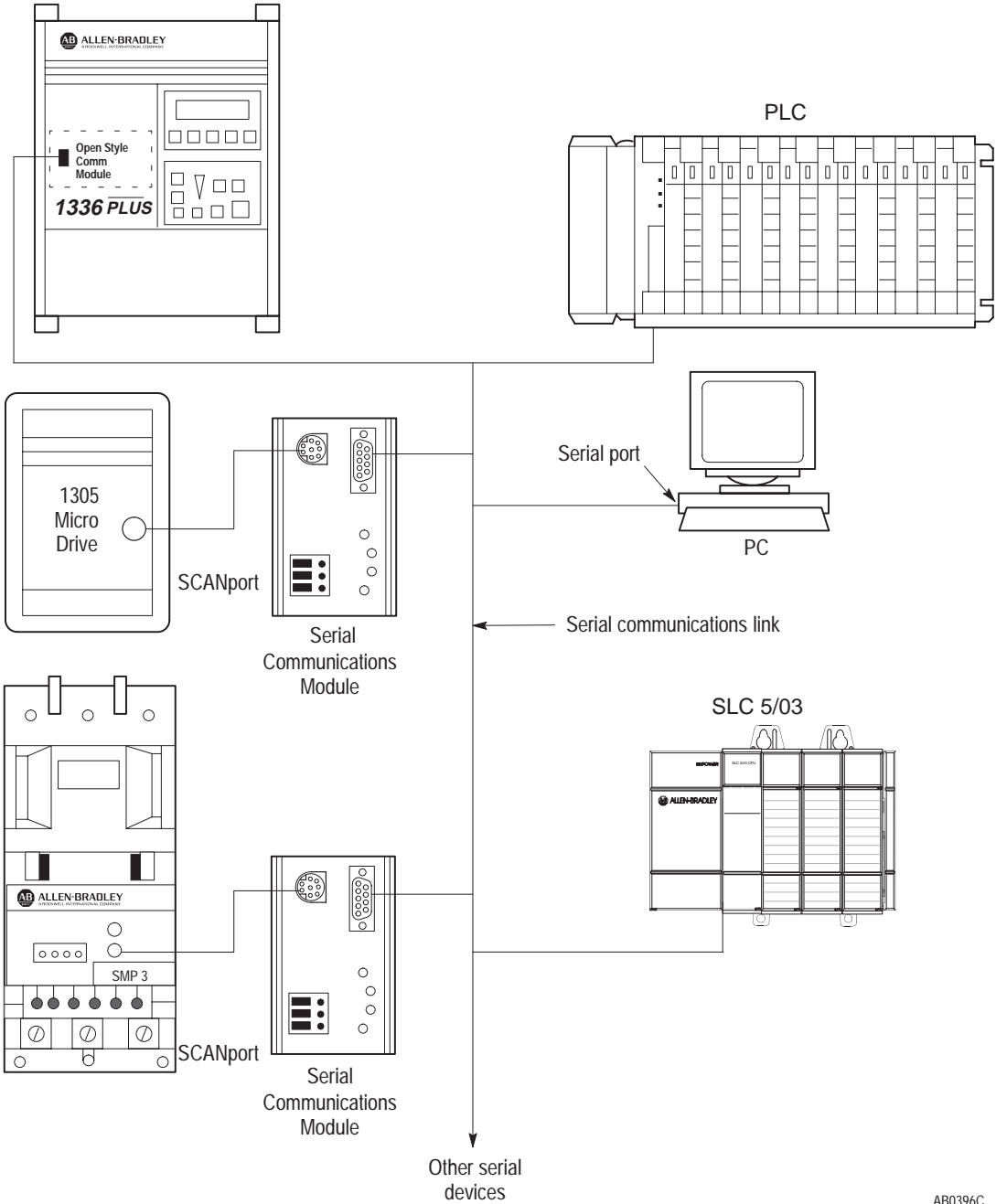

AB0396C

Configuration Switches

The Serial Communications Module contains three DIP Switches: SW1, SW2, and SW3 (Figure 1.1 and Figure 1.2). Switches are set ON or OFF as shown in Figure 1.4. For a detailed explanation of switch configuration, refer to Chapter 2.

Figure 1.4
Configuration Switches

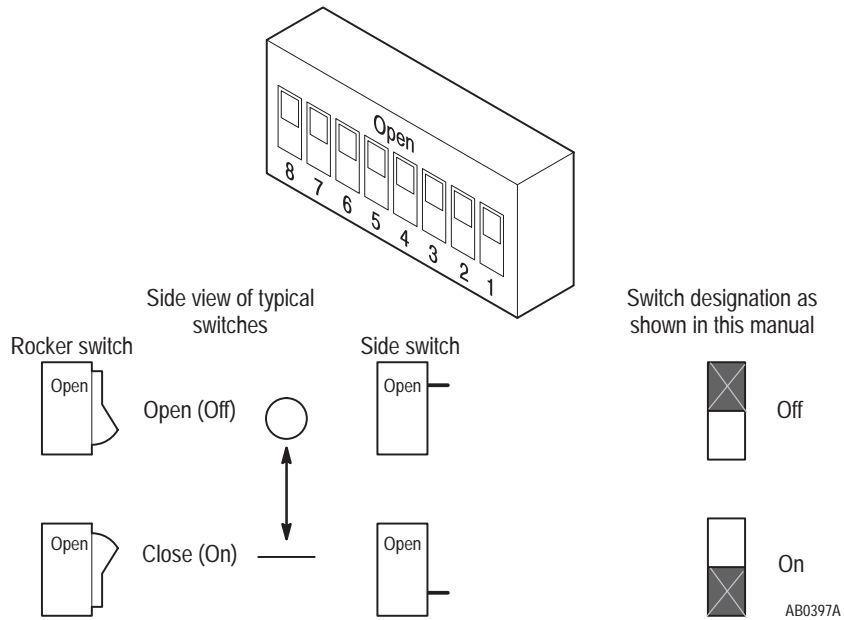

Installation

Chapter Objectives

In this chapter, you will learn how to:

- set the module configuration switches
- mount the Serial Communications Module
- connect the cables
- connect the SCANport link
- connect the power supply

Read this chapter completely before you attempt to install or configure your Serial Communications Module. Double check all connections and option selections before you apply power.

Important: Switch selections take effect only on power-up. If you change selections after power is applied, cycle the power to use the new settings.

Setting Module Configuration Switches

When making configuration changes to the Serial Communications Module, use the addressing conventions of the PLC/SLC processor or serial device through which you are communicating. In all cases, each serial device must have a unique address that the target processor can recognize.



ATTENTION: When changing the switch settings, use a blunt, pointed instrument such as a ball point pen. Do not use a pencil because the lead (graphite) of the pencil may damage the switch assembly.



ATTENTION: Failure to check connections and switch settings for compatibility with your application when configuring the communications module could result in personal injury and/or equipment damage due to unintended or undesirable operation.



ATTENTION: It is recommended that when a system is configured for the first time, you should disconnect the motor from the machine or process during the initial testing.

This publication describes switches as being either on or off. If the switch assembly has the word OPEN printed on it, the word OPEN corresponds to OFF (0).

If a switch is shown as gray, then that switch does not affect the function being covered.

Factory Switch Settings

The following table shows the switch settings that are set at the factory:

Switch	Setting	Communication Mode
SW3-8	Off	Default application timeout disabled
SW3-7	Off	
SW3-6	Off	Duplicate message detection disabled
SW3-5	Off	Datalink D disabled
SW3-4	Off	Datalink C disabled
SW3-3	Off	Datalink B disabled
SW3-2	Off	Datalink A disabled
SW3-1	Off	Logic command/status and reference/feedback disabled
SW2-8	Off	BCC checksum
SW2-7	Off	Point-to-point
SW2-6	Off	1 stop bit
SW2-5	Off	Even parity (if enabled)
SW2-4	Off	Parity disabled
SW2-3	On	9600 baud
SW2-2	On	
SW2-1	Off	
SW1-8	Off	Module address = 1
SW1-7	Off	
SW1-6	Off	
SW1-5	Off	
SW1-4	Off	
SW1-3	On	
SW1-2	Off	RS-232 (DF1 protocol)
SW1-1	Off	

These switches can be visually represented as follows:

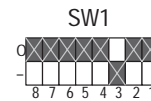
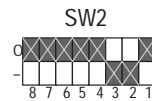
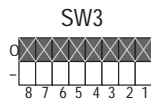

Switch SW1

Switch SW1 is used to select:

- serial communications mode (RS-232/RS-422/RS-485/DH-485)
- Serial Communications Module address

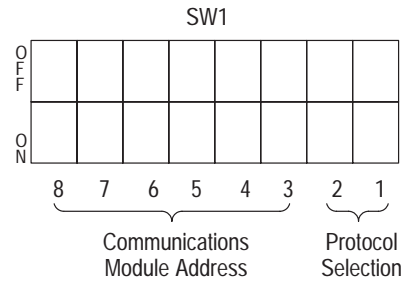

AB0398B

Use SW1-1 and SW1-2 to select the communications protocol you are using:

Switch Value (Decimal)	SW1	Protocol
0		RS-232 (DF1 protocol)
1		RS-422 (DF1 protocol)
2		RS-485 (DF1 protocol)
3		DH-485

Use SW1-3, SW1-4, SW1-5, SW1-6, SW1-7, and SW1-8 to set your address for the Serial Communications Module. The following table provides the switch settings for selecting the serial device addressing.











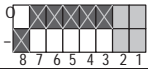
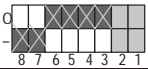
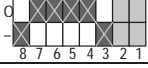
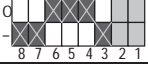















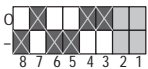
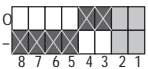

Note: If you are using the DH-485 communications mode, the highest serial device address you can select is 31 (decimal).

DF1/DH-485 Address Selection

Module Address (Decimal)	Module Address (Octal)	SW1		Module Address (Decimal)	Module Address (Octal)	SW1
0	0			16	20	
1	1			17	21	
2	2			18	22	
3	3			19	23	
4	4			20	24	
5	5			21	25	
6	6			22	26	
7	7			23	27	
8	10			24	30	
9	11			25	31	
10	12			26	32	
11	13			27	33	
12	14			28	34	
13	15			29	35	
14	16			30	36	
15	17			31	37	

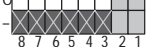
DF1 Address Selection

Module Address (Decimal)	Module Address (Octal)	SW1		Module Address (Decimal)	Module Address (Octal)	SW1
32	40			48	60	
33	41			49	61	
34	42			50	62	
35	43			51	63	
36	44			52	64	
37	45			53	65	
38	46			54	66	
39	47			55	67	
40	50			56	70	
41	51			57	71	
42	52			58	72	
43	53			59	73	
44	54			60	74	
45	55			61	75	
46	56			62	76	
47	57			63	77	

Allen-Bradley Spares

Switch SW2

Switch SW2 is used to select:

- baud rate
- parity
- number of stop bits
- point-to-point or multi-drop
- checksum mode (CRC or BCC)

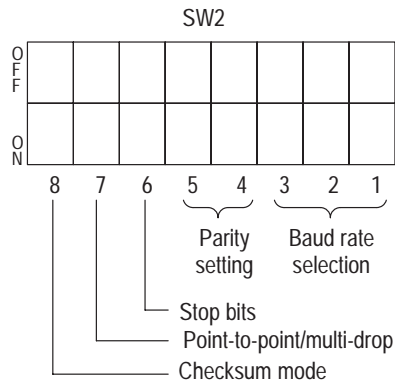

AB0399A

Use SW2-3, SW2-2, and SW2-1 to select the baud rate:

Switch Value (Decimal)	SW2	Baud Rate
0		110
1		300
2		600
3		1200
4		2400
5		4800
6		9600
7		19200



Note: For DH-485, 1200, 2400, 9600, and 19200 are the allowed baud rates. Selecting any other baud rate will cause the module to indicate a fault. The module cannot operate in this state.



Note: If you are using the DH-485 communications mode, setting switches SW2-4, SW2-5, SW2-6, SW2-7, and SW2-8 have no effect because this information is selected within the software.

Use SW2-5 and SW2-4 to set the parity:

SW2	Function
	Parity disabled
	Even parity
	Odd parity

Use SW2-6 to choose between 1 stop bit and 2 stop bits:

SW2	Function
	1 stop bit
	2 stop bits

Use SW2-7 to choose between point-to-point and multi-drop:

SW2	Function
	Point-to-point
	Multi-drop

Use SW2-8 to choose between BCC checksum mode and CRC checksum mode:

SW2	Function
	BCC Checksum
	CRC Checksum

Switch SW3

Switch SW3 is used to select:

- logic command/status and reference/feedback
- datalinks (up to four datalinks)
- duplicate message detection
- application timeout default value

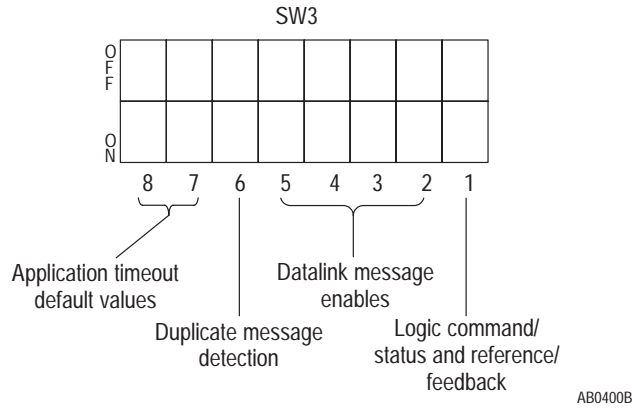

Use SW3-1 to enable and disable the logic command/status and reference/feedback messaging:

SW3	Function
	Disable logic command/status and reference/feedback messaging.
	Enable logic command/status and reference/feedback messaging.



Use SW3-2 to enable and disable Datalink A messaging:

SW3	Function
	Disable Datalink A messaging.
	Enable Datalink A messaging.

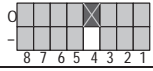

Use SW3-3 to enable and disable Datalink B messaging:

SW3	Function
	Disable Datalink B messaging.
	Enable Datalink B messaging.

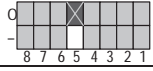

Use SW3-4 to enable and disable Datalink C messaging:

SW3	Function
	Disable Datalink C messaging.
	Enable Datalink C messaging.

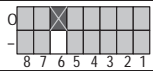

Use SW3-5 to enable and disable Datalink D messaging:

SW3	Function
	Disable Datalink D messaging.
	Enable Datalink D messaging.

Use SW3-6 to enable and disable duplicate message detection:

SW3	Duplicate Message Detection
	Disable duplicate message detection.
	Enable duplicate message detection.

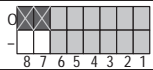
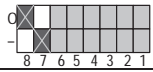
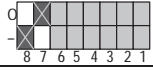
Use SW3-7 and SW3-8 to set the default application timeout value. The default value is used for application timeout unless the user writes a value to the application timeout address in the Serial Communications Module data table. This address is N42:3. If power is removed, the default value is reloaded during power-up.

SW3	Application Timeout Default Value
	No timeout (disabled)
	1 second
	30 seconds
	60 seconds

In DH-485 mode, the application timeout function is as follows:

- If the application timeout is set to zero, the module will not cause the SCANport device to fault if DH-485 communications are disrupted.
- If the application timeout is set to a non-zero value, the module causes the SCANport device to fault if a DH-485 device that had sent a message to data table N41 drops off the network.

Mounting the Serial Communications Module

The Serial Communications Module can be provided in three mounting configurations:

- Open style board, factory installed in a drive (not available for all drives)
- Open style board as a separate kit
- Enclosed style for panel mount or DIN rail mount

This section provides mounting information for the Open style kit and the Enclosed style.

Open Style Communications Module Mounting Location (1336 PLUS 7.5-500HP)

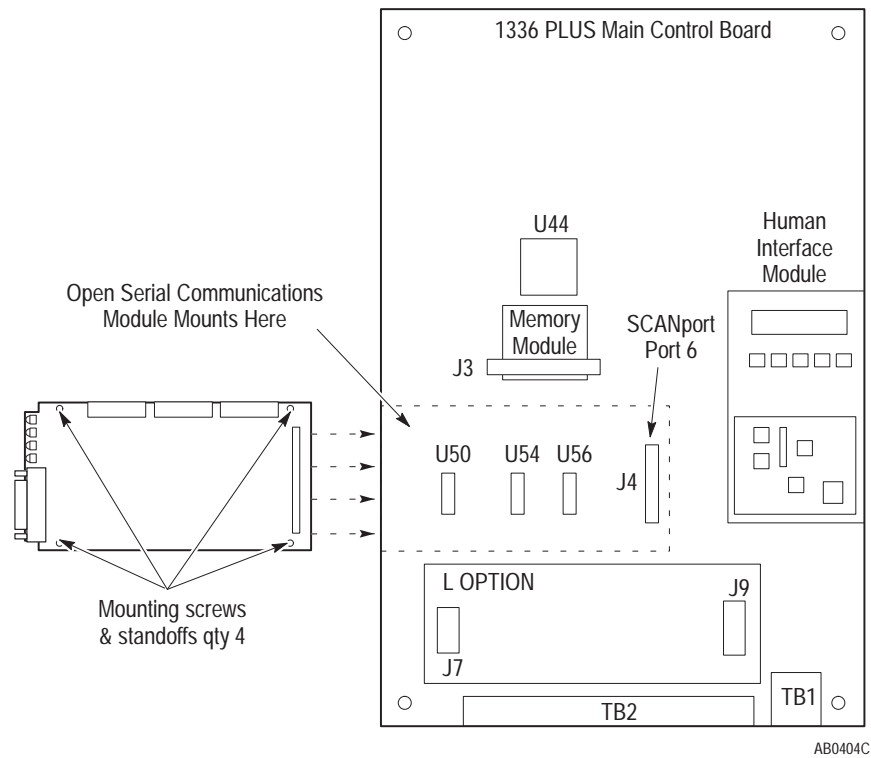

**Enclosed Style Communications Module Mounting Location
(1336 FORCE and 1336 PLUS Drives)**

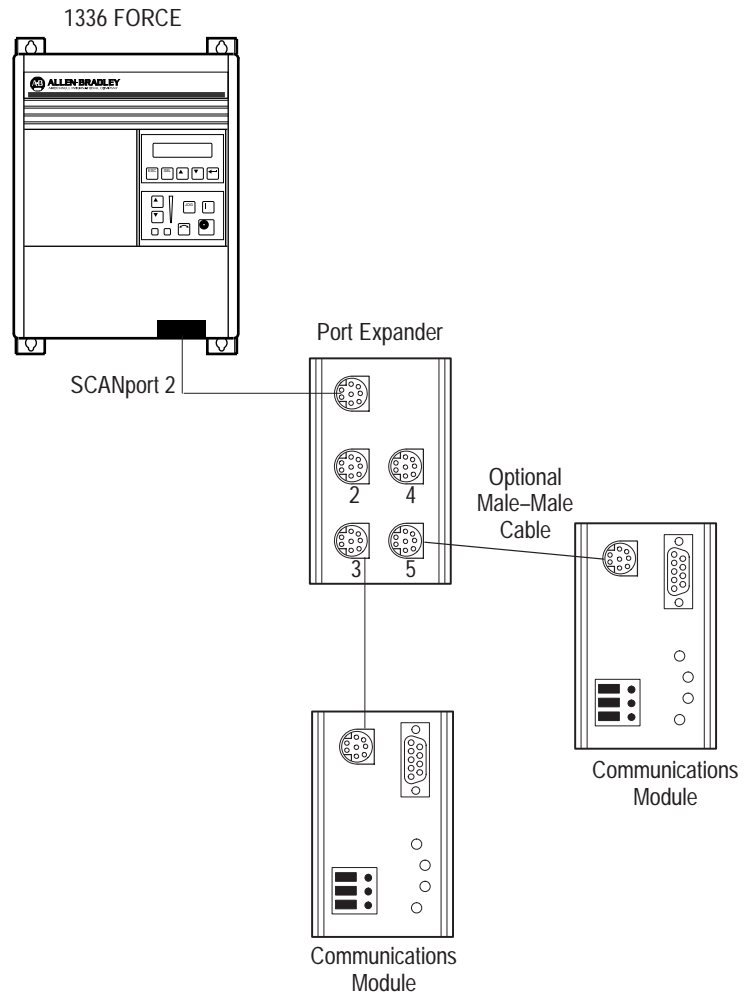

Allen-Bradley Spares

Enclosed Style Serial Communications Module Dimensions

Enclosed Style Serial Communications Module Dimensions

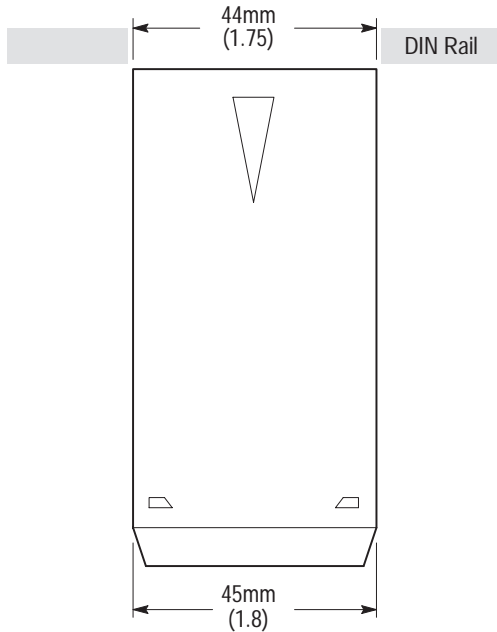

Top View

Notes:

- The enclosure requires clearance at the top and bottom for proper cooling. Additional space is required if you want to access the DIP switches without removing the device.
- All dimensions are given in millimeters and (inches).

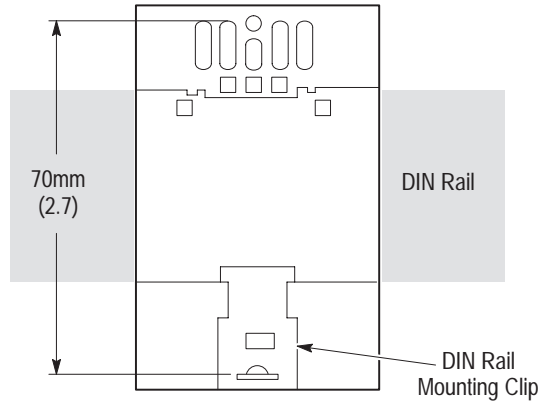

Back View

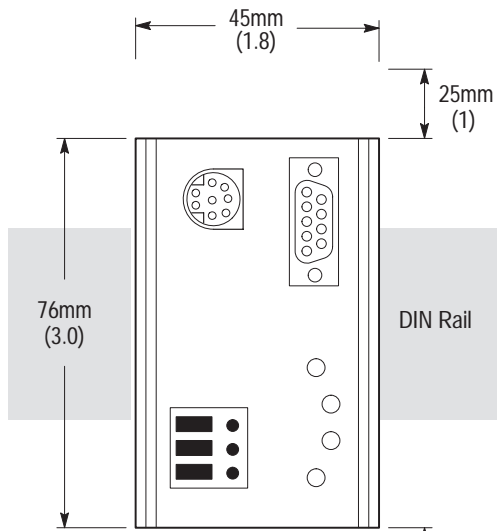

Front View

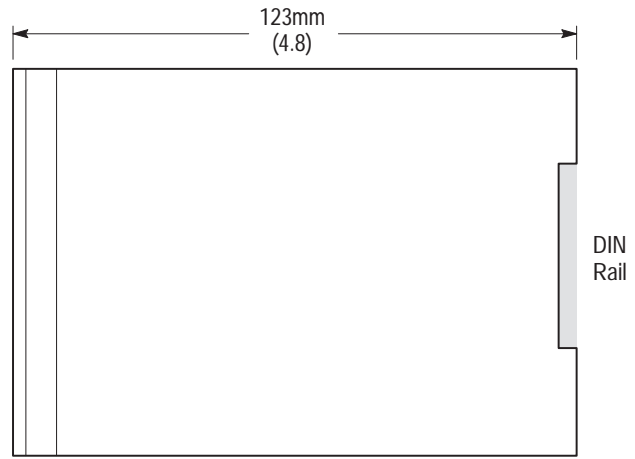

Side View

AB0406A

Connecting Cables

This section provides information that you need to connect the cables to your Serial Communications Module.

Important: When connecting your cables, you should make sure that the network is properly terminated. You should also ground the shield at the end furthest from the Serial Communications Module.

1746-BAS Module Serial Connections

Serial Communications Module to 1746-BAS Module
PRT1, PRT2 RS-232 Mode Port Connection Diagram

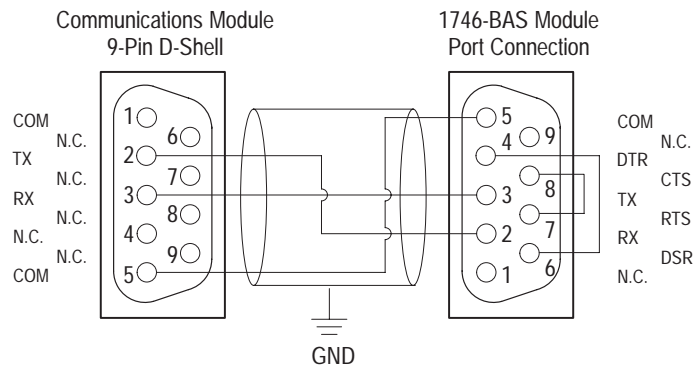

Serial Communications Module to 1746-BAS Module
PRT1, PRT2 RS-422 Mode Port Connection Diagram

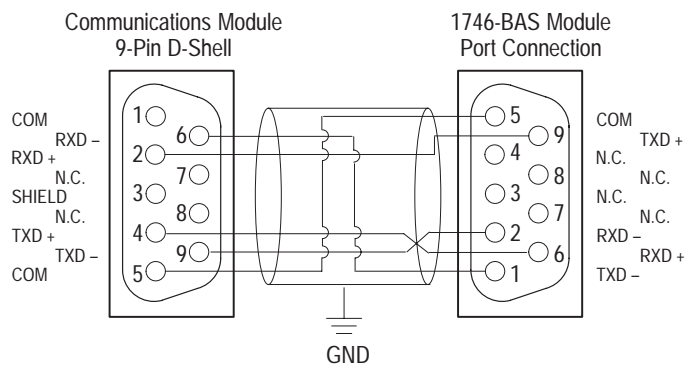

Serial Communications Module to 1746-BAS Module
PRT1, PRT2 RS-485 Mode Port Connection Diagram

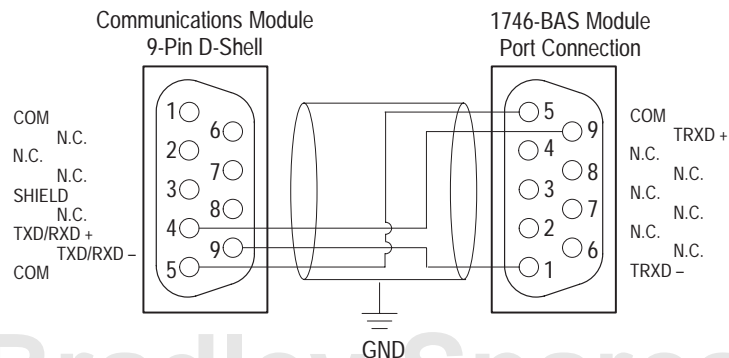

IBM PC Compatible Serial Connections

RS-485/RS-422/RS-232 Communications Adapter to IBM AT Compatible Computer RS-232 Serial Port Connection Diagram

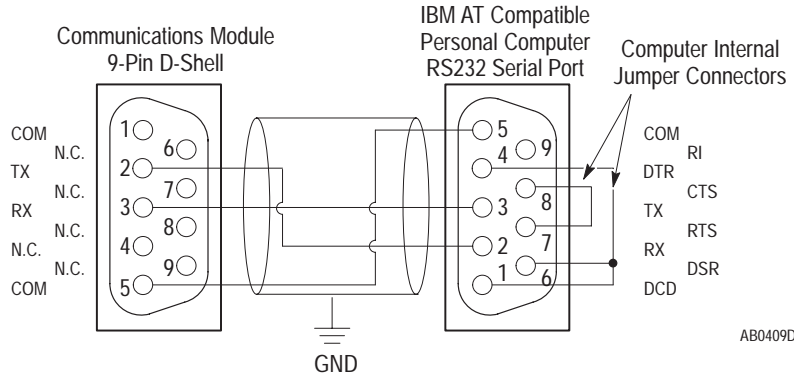

1747-AIC Link Coupler Serial Connections

Serial Communications Module to 1747-AIC Link Coupler PRT1, PRT2 DH-485 Mode Port Connection Diagram

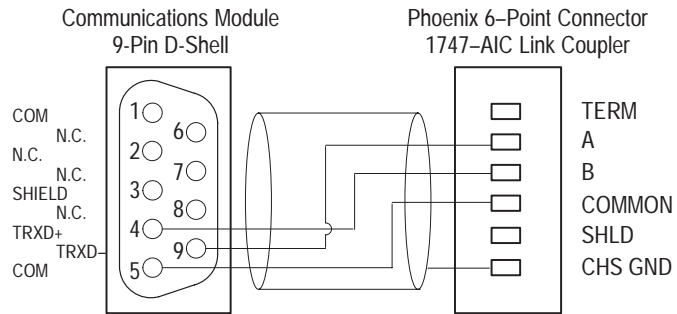

PLC5 Channel 0 Serial Connections

Serial Communications Module to PLC5 RS-232
Serial Port Connection Diagram

PLC5/20, 5/40, 5/60, 5/80
Channel 0

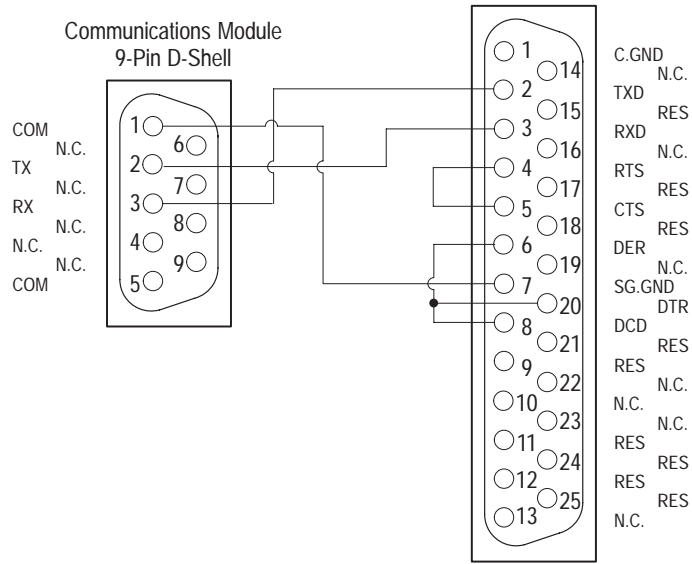

AB0486B

SLC 5/03 Port 1 Serial Connections

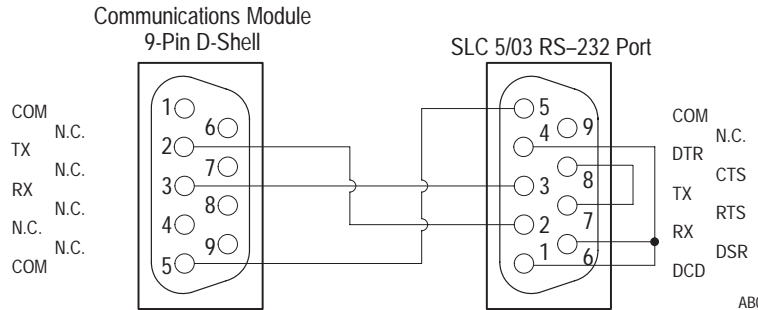

AB0411B

SCANport Link Connection

Cable Requirements

SCANport cables are available in either male-to-male or male-to-female configuration. You can connect cables of up to 10 meters (33 feet) from the master to the SCANport device (A in the figure below). If you use a Port Expander (as shown in the figure below), you need to subtract the cable length from the master to the Port Expander from the cable length used to connect the device to the expander ($B1 + C =$ a maximum of ten meters).

1305 Drive

An Allen-Bradley SCANport link cable is used to connect the Serial Communications Module to the drive (as shown below).

SCANport Connection on Serial Communications Module

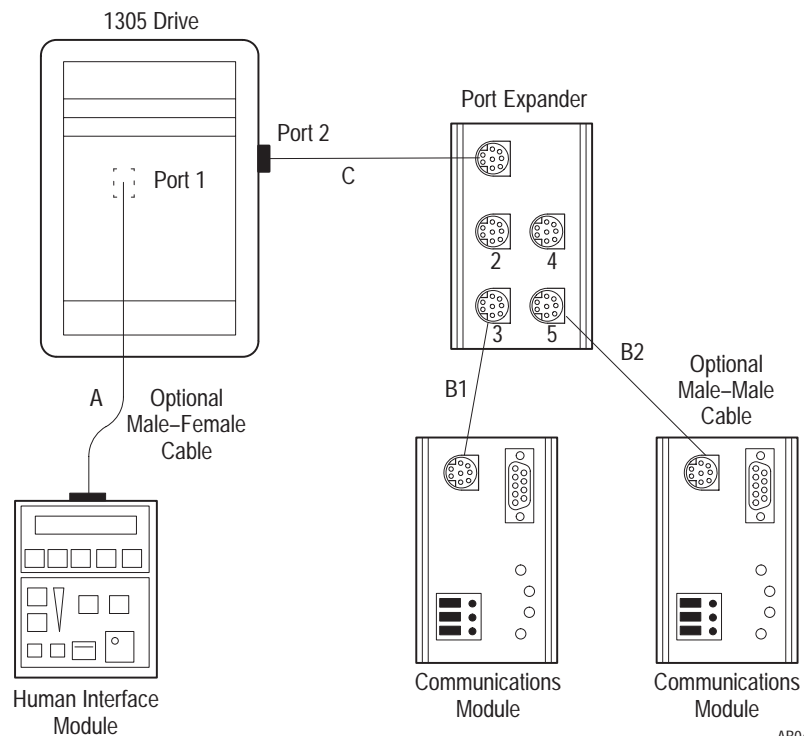

AB0407B

Important: The maximum cable distance between any two devices cannot exceed 10 meters (33 feet) of cable.

For example: $A + B1 + C \leq 10$ meters
 $A + B2 + C \leq 10$ meters
 $B1 + B2 \leq 10$ meters

1336 PLUS and 1336 FORCE

Refer to the product manual for connection information. On larger horsepower 1336 PLUS and FORCE drives with an open Serial Communications Module mounted in the drive, you do not need a separate SCANport cable connection.

Connection information for the 1336 PLUS and 1336 FORCE is shown on page 2-11.

Important: The maximum cable distance between any two devices cannot exceed 10 meters (33 feet) of cable.

1394

Refer to the product manual for connection information.

SMP 3

An Allen-Bradley SCANport cable is used to connect the Serial Communications Module to an SMP3.

Important: The maximum cable distance between any two devices cannot exceed 10 meters (33 feet) of cable.

SCANport Connection on Serial Communications Module

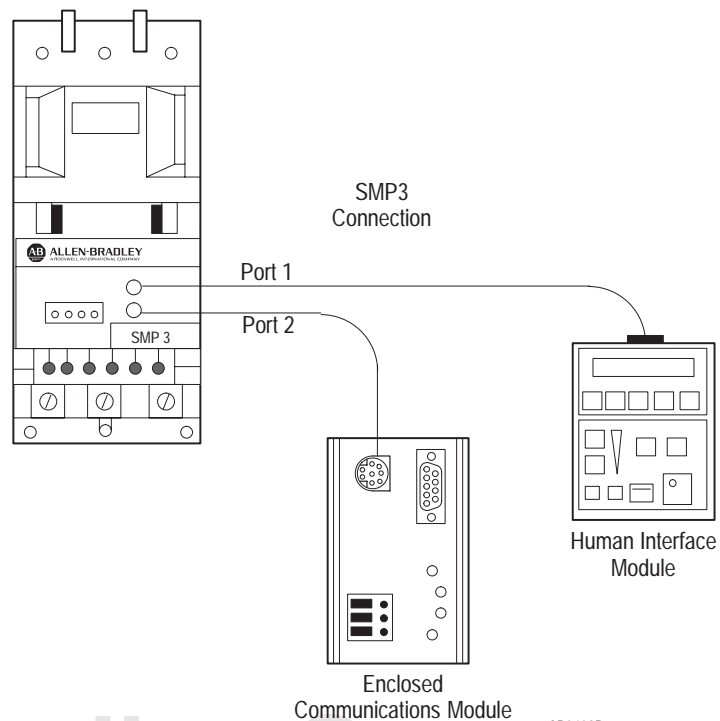

Allen-Bradley Spares

Power Supply Connections

The Enclosed Communications Module is powered from a separate 24V DC or 115/230V AC power supply (as shown below). With the Open Style Communications Module board mounted in the drive, no separate power supply connections are required.

Typical Power Supply Connection

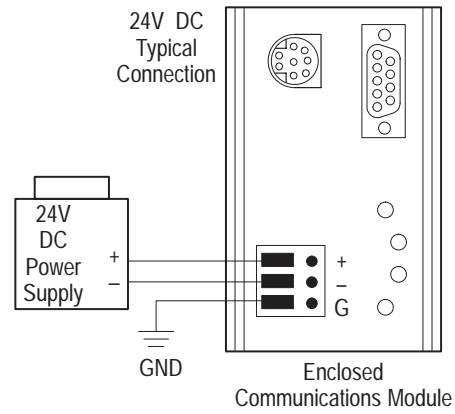
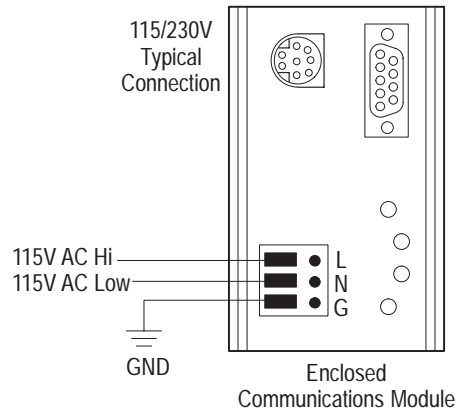

AB0413B

SCANport Datalink Operation

Chapter Objectives

In this chapter, you will read about SCANport Datalinks.

SCANport Datalinks

A Datalink is a type of pointer function used by some SCANport devices to transfer parameter values to and from the SCANport device. The Datalink function transfers parameters on a regular schedule. Reading a parameter using the Datalink function (data table N41) requires less time than reading a parameter using the Parameter Value Read data table addresses (data tables N10 – N19 or N50 – N89) because the module is kept updated on the parameter value.

SCANport devices that support this function have a group of parameters for Datalink configuration. These parameters are identified as *Datalink In* and *Datalink Out* parameters. To enable the Datalink functions, you need to:

1. Set the correct switch to *Enable* on SW3 of the Serial Communications Module.
2. Configure the *Datalink In* and *Datalink Out* parameters in the SCANport device.

Each Datalink consists of two 16-bit words of input and two 16-bit words of output. You can configure each of the two input words to write to a different destination parameter within the SCANport device by setting the two *Datalink In* parameters for that Datalink to the desired destination parameters. Similarly, you can configure each of the two output words by setting the two *Datalink Out* parameters for that Datalink.

Each Datalink switch on SW3 can enable or disable one Datalink.

- If a Datalink is enabled, the value of the parameters set into the *Datalink Out* parameters is transferred to the Serial Communications Module and the data sent by the Serial Communications Module for the Datalink is transferred into the parameters set into the *Datalink In* parameters.
- If a Datalink is not enabled, the data transferred to the SCANport device for that Datalink is zero and the Serial Communications Module ignores any data sent by the SCANport device.

If no *Datalink In* parameter is configured for an input word, that word is ignored. If no *Datalink Out* parameter is configured for an output word, the output word is undefined (usually set to zero).

Configuring and Interfacing

Chapter Objectives

This chapter provides you with information on how the Serial Communications Module communicates with a serial device. The following topics are explained:

- Serial Communications Module data table structure
- configuration examples



ATTENTION: When you configure a system for the first time, you should disconnect the motor from the machine or the process during the initial testing.

Serial Communications Module Data Table Structure

The Serial Communications Module maintains a data table that allows the module to communicate with serial devices using standard PCCC commands.

Supported PCCC Command List

The Serial Communications Module supports the following PCCC Commands:

CMD Code	FNC Code	Command Name	PLC Addressing Method
01h	n/a	Unprotected read	PLC-2 address
06h	00h	Echo	n/a
	01h	Read diagnostic counters	Variable (modified PLC-2 addresses)
	02h	Set variables (#ENQs, #NAKs, TIMEOUT)	n/a
	03h	Identify host and some status	n/a
	04h	Set timeout	n/a
	05h	Set #NAKs	n/a
	06h	Set #ENQs	n/a
	07h	Reset diagnostic counters	n/a
	09h	Read link parameters	Logical address
	0Ah	Set link parameters	Logical address
08h	n/a	Unprotected write	PLC-2 address
0Fh	67h	Typed write	System address (4 possibilities)
	68h	Typed read	System address (4 possibilities)
	A1h	Protected typed logical read with two address fields	File number/type/element number
	A2h	Protected typed logical read with three address fields	File number/type/element number/sub-element number
	A9h	Protected typed logical write with two address fields	File number/type/element number
	AAh	Protected typed logical write with three address fields	File number/type/element number/sub-element number
	ABh	Protected typed logical write with four address fields	File number/type/element number/sub-element number/bit mask

Data Table Structure

The Serial Communications Module provides the following data table structures for DF1 and DH-485.

The following table is the drive control table (binary file).

File Address	Description	File Address	Description
B3:0	Logic Command	B3:10	Logic Status
B3:1	Reference	B3:11	Feedback
B3:2	Datalink A1 In (to Drive)	B3:12	Datalink A1 Out (from Drive)
B3:3	Datalink A2 In (to Drive)	B3:13	Datalink A2 Out (from Drive)
B3:4	Datalink B1 In (to Drive)	B3:14	Datalink B1 Out (from Drive)
B3:5	Datalink B2 In (to Drive)	B3:15	Datalink B2 Out (from Drive)
B3:6	Datalink C1 In (to Drive)	B3:16	Datalink C1 Out (from Drive)
B3:7	Datalink C2 In (to Drive)	B3:17	Datalink C2 Out (from Drive)
B3:8	Datalink D1 In (to Drive)	B3:18	Datalink D1 Out (from Drive)
B3:9	Datalink D2 In (to Drive)	B3:19	Datalink D2 Out (from Drive)



Note: If you write to B3:0 through B3:9, you will write data to the drive. If you read from B3:0 through B3:9, you will return the data being currently sent to the drive. If you read from B3:10 through B3:19, you will read data from the drive. If you write to B3:10 through B3:19, you will receive an error.

The following table is the drive control table (integer file).

File Address	Description
N41:0	Logic Command/Status
N41:1	Reference/Feedback
N41:2	Datalink A1
N41:3	Datalink A2
N41:4	Datalink B1
N41:5	Datalink B2
N41:6	Datalink C1
N41:7	Datalink C2
N41:8	Datalink D1
N41:9	Datalink D2



Note: If you write to any location in N41, you will write data to the drive. If you read from any location in N41, you will read data from the drive.

Important: The following two tables list the typical control and status structure. You should refer to your drive manual for the actual control and status structures for your device.

The following are the bit definitions for B3:0 or writes to N41:0:

Bit	Description	Bit	Description
00	Stop	10	Acceleration time
01	Start	11	Acceleration time
02	Jog	12	Deceleration time
03	Clear faults	13	Deceleration time
04	Direction	14	Reference select
05	Direction	15	Reference select
06	Local	16	Reference select
07	MOP increment	17	MOP decrement

The following are the bit definitions for B3:10 or reads from N41:0:

Bit	Description	Bit	Description
00	Enabled	10	At speed
01	Running	11	Local
02	Command direction	12	Local
03	Actual direction	13	Local
04	Accelerating	14	Reference select
05	Decelerating	15	Reference select
06	Alarm	16	Reference select
07	Faulted	17	Reference select

The following is the data table structure for PLC-2 style addressing:

Parameter Number	PLC-2 Style Address Decimal (Octal)	Description of Location's Purpose
1 - 7039	512 + Parm # (1000 to 16577)	Parameter value read
	(16600 to 167770)	Status of last parameter write
1 - 7039	7680 + Parm # (17000 to 34577)	Parameter read full
	(34600 to 34677)	Block transfer emulation area
	(34700)	Logic command/status
	(34701)	Reference/feedback
	(34702)	Datalink A1
	(34703)	Datalink A2
	(34704)	Datalink B1
	(34705)	Datalink B2
	(34706)	Datalink C1
	(34707)	Datalink C2
	(34710)	Datalink D1
	(34711)	Datalink D2
	(34712)	#ENQs
	(34713)	#NAKs
	(34714)	Message TIMEOUT (mS)
	(34715)	Application TIMEOUT (seconds)
	(34716)	Adapter series number (2=B)
	(34717)	Adapter firmware version (201=FRN2.01)
	(34720)	Maximum node address (DH-485)
	(34721 to 37677)	Reserved area for future expansion
(37700 to 37777)	System area	



Note: The address locations shown in this table are not limited to PLC-2 commands and may be used by any device that can generate them.

The following is the data table structure for the Serial Communications Module:

Parameter Number	File Addresses	Description of Location's Purpose
1 - 999	N10:1 - 999	Parameter value read or write
1000 - 1999	N11:0 - 999	
-	-	
8000 - 8999	N18:0 - 999	
9000 - 9999	N19:0 - 999	
1 - 249	N50:1 - 249	Parameter value read or write
250 - 499	N51:0 - 249	
-	-	
9500 - 9749	N88:0 - 249	
9750 - 9999	N89:0 - 249	
	N20:0 - 127	Status of last parameter write
1-999	N30:1 - 999	Parameter read full
1000 - 1999	N31:0 - 999	
-	-	
8000 - 8999	N38:0 - 999	
9000 - 9999	N39:0 - 999	
1 - 249	N90:1 - 249	Parameter read full
250 - 499	N91:0 - 249	
-	-	
9500 - 9749	N128:0 - 249	
9750 - 9999	N129:0 - 249	
	N40:0 - 63	Block transfer emulation area
	N41:0	Logic command/status
	N42:0	#ENQs
	N42:1	#NAKs
	N42:2	Message TIMEOUT (mS)
	N42:3	Application TIMEOUT (Seconds)
	N42:4	Adapter series number (2 = B)
	N42:5	Adapter firmware version (201=FRN2.01)
	N42:6	Maximum node address (DH-485)
	System File 0 (or N200:1 - 63)	Station name (DF1) SLC compatible system file (DH-485)



Note: Some devices cannot access an element number over 254. The files from N50 to N129 are intended for use with those devices.

The data tables have up to eight areas, each having a different purpose.

- 1. Parameter Value Read or Write (N10 – N19, N50 – N89).**
Reading data from files in this area will cause the Serial Communications Module to read parameter values from the SCANport device and send those values as the response to the read message. Writing data to files in this area will cause the Serial Communications Module to write that data into SCANport device parameters.
- 2. Status of Last Parameter Write (N20).** This area is read-only. When read, the data returned contains status information from the last parameter write that was performed by the Serial Communications Module. If no errors occurred during the write, all of the data returned will be zeros. Read this area beginning at element number zero.
- 3. Parameter Read Full (N30 – N38, N90 – N129).** This area is read-only. When read, the data returned consists of 20 words (40 bytes) of information about each parameter including scaling, parameter text, units text, minimum, maximum, and default values. When reading this area, set the number of elements to twenty times the number of parameters to be read.
- 4. Block Transfer Emulation Area (N40).** This area provides a method for sending and receiving SCANport messages to and from the SCANport device. This allows you to perform every SCANport command the device supports. Chapter 5 provides information about the block transfer emulation functions available for use with the Serial Communications Module.

To send a SCANport message, write data into this area beginning with element number zero. Allow sufficient time for the SCANport device to respond to the message and then read the response message from this area beginning with element number zero.
- 5. Producer/Consumer Emulation Area (N41).** Each element in this area has a different function. Refer to the DIP switch configuration tables in Chapter 3 for more information.
 - Logic Command/Status. Writing sends a Logic Command to the drive. Reading supplies the SCANport device Logic Status. Refer to the manual supplied with the SCANport device for more information.
 - Reference/Feedback. Writing sends a reference to the SCANport device. Reading supplies feedback from the SCANport device. The meaning of the reference and feedback values depend on the type of SCANport device.

- Datalink A1. Writing to *Datalink A1* sends a value to the parameter pointed to by the *DataIn A1* parameter of the SCANport device. Reading from *Datalink A1* reads the value of the parameter pointed to by the *DataOut A1* parameter of the SCANport device.
- *Datalink A2* through *Datalink D2* function the same as *Datalink A1*.

6. Serial Communications Module Parameters (N42). Each of the four elements in this area can be read or written and affects the operation of the Serial Communications Module as follows:

- Number of ENQ's. The number of ENQ's sent by the module before giving up on receiving ACK or NAK. The default is 3.
- Number of NAK's. The number of times the module will resend a message if the response is always NAK. The default is 3.
- Message Timeout. The number of milliseconds the module will wait before sending an ENQ. The default is 100mS.
- Application Timeout. The number of seconds the module will wait between messages before faulting the SCANport device it is connected to. The default is set by the configuration DIP switches.
- Adapter Series Number. The series letter of the 1203 Serial Communications Module expressed as a number. For example, 1=A, 2=B, and so forth.
- Adapter Firmware Version. The firmware version number of the 1203 Serial Communications Module. For example, 201=FRN2.01, 202=FRN2.02, and so forth.
- Maximum Node Address. When in DH-485 mode, this parameter sets the maximum node address that the adapter will attempt to communicate with. The default value is 31 (decimal).

7. Reserved for Future Expansion. If you try a read or write to any address in this area, the Serial Communications Module will respond with an error message.

8. System Area. Performing a read from this area will cause the Serial Communications Module to respond with a 22-character string. This string is set at power-up to contain the Product Text String from the SCANport device with /1203 appended to it. Writing to this area changes the characters contained in the string. Cycling power returns the string to its original text.

Configuration Examples

DF1 Messaging with a PLC-5/80 Example

This example reads parameters 1 through 50.

Ladder rung example for Gx2 manual

Rung 2:0

```

| I:000 MG20:0   B3                               +MSG-----+      |
+--] [---]/[---[ONS]-----+SEND/RECEIVE MESSAGE  +- (EN) -+ |
|   00   EN      2                               |Control block  MG20:0+- (DN) |
|                                                    |             +- (ER) |
|                                                    +-----+      |

```

Data Table Report

MESSAGE INSTRUCTION DATA MONITOR FOR CONTROL BLOCK MG20:0

```

Communication Command:          PLC-5 TYPED READ
PLC-5 Data Table Address:      N30:0   ignore if timed-out:  0 TO
Size in Elements:              50      to be retried:        0 NR
Local/Remote:                  LOCAL   awaiting execution:    0 EW
  Remote Station:              N/A     continuous:          0 CO
  Link ID:                      N/A     error:               0 ER
  Remote Link Type:            N/A     message done:        0 DN
Local Node Address:            001     message transmitting: 0 ST
Destination Data Table Address: N10:1  message enabled:      0 EN
Port Number:                    00

```

Error Code: 0000 (HEX)



Notes:

- I:000/00 is any application–related conditioning logic.
- MG20:0.EN is the enabled status bit from the message block.
- B3/2 is a one-shot that causes the message to be resent each time the message block completes or errors (as long as I:000/00 is true).
- The DF1 address of the PLC-5 is the same as its DH+ address (set by DIP switch SW1 on the PLC-5).
- Refer to Publication 6200–6.4.11, *Instruction Set Reference*, for information on the MSG block.
- Refer to Publication 1785–6.6.1, *Hardware Installation Manual*, for information on configuring the PLC-5 Channel 0 hardware.
- Refer to Publication 6200–6.4.6, *Software Configuration and Maintenance*, for information on configuring the PLC-5 Channel 0 driver.
- Only one message may be active to a Serial Communications Module at any time. When you write the PLC program, you must ensure this requirement.

DF1 Messaging with a 1746-BAS Module Example

This example accepts a parameter number and a value from a user terminal and writes the data out to a SCANport-compatible device.

```

100 REM _____
101 REM __ This program inputs a parameter number and a value
102 rem __ from a user terminal and writes it out to a scanport
103 rem __ compatible device.
104 rem __ for 1746-BAS and 1203-GD2 modules
105 rem _____
110 STRING 512,127
140 REM
150 REM -----
160 REM Setup port 1 to 9600 baud, no parity, 8 bits, 1 stop bit,
170 REM software handshaking, and battery backed ram data storage.
180 REM      !!!!REMEMBER TO SET TERMINAL TO MATCH!!!!
190 REM -----
200 MODE (PRT1,9600,N,8,1,S,R)
210 REM -----
220 REM
230 REM Setup port 2 to 300 baud, no parity, 8 bits, 1 stop bit,
240 REM software handshaking, and battery backed ram data storage.
250 REM
260 REM -----
270 MODE (PRT2,300,N,8,1,S,R)
280 REM -----
290 REM
300 REM Enable DF1 driver
310 REM (20 = Setup for Full Duplex, Auto-Detect Embedded Responses,
320 REM      Disable Duplicate Packet Detection, BCC error checking)
330 REM (200 = Wait 1 second for polling by Master)
340 REM (2 = 2 retries)
350 REM (0= No RTS on delay)
360 REM (0 = No RTS off delay)
370 REM (8 = 1746-BAS module address)
380 REM -----
390 PUSH 20
400 PUSH 200
410 PUSH 2
420 PUSH 0
430 PUSH 0
440 PUSH 8
450 CALL 108
460 REM _____ end df1 config _____
461 Print: print "A negative parameter number exits the program "
470 INPUT "Offset (Parameter Number)? ",PAR_NUM
475 IF (PAR_NUM<0) THEN GOTO 530
480 INPUT "Control (parameter value)? ",PAR_VALUE
481 REM encode the value as an ASCII hex string in order of LOW, HIGH
490 ASC$(1,1)=PAR_VALUE-(INT(PAR_VALUE/256)*256)
500 ASC$(1,2)=INT(PAR_VALUE/256)
510 GOSUB 550 : REM fire off the write instruction
520 GOTO 460
530 CALL 113
540 END

```

Allen-Bradley Spares

```
550 REM *****
560 REM *****      PLC TYPED READ Subroutine      *****
561 REM *****      inputs  Parameter number in var  PAR_NUM  *****
562 REM *****      ASC coded hex string of value in  $(1)    *****
563 REM *****      outputs:  failure message          *****
565 REM *****
570 REM subroutine to do a typed write of a single parameter
580 PRINT "Executing PLC Remote Write "
600 PUSH 5 : REM PLC5 Typed Write
610 PUSH 1 : REM Communications Module Node Address
620 PUSH 10 : REM File Number ( address is N10:PAR_NUM)
630 PUSH ASC(N) : REM Communications Module File Type
640 PUSH PAR_NUM : REM Starting Word in File
650 PUSH 1 : REM Number of Words to Transfer (one parameter)
660 PUSH 50 : REM Command Time-out (x100ms)
670 PUSH 2 : REM Data Source (2 = Internal String)
680 PUSH 0 : REM Offset in M0 file (Not used in this example)
690 PUSH 1 : REM String #  ASCII hex number order low, high
700 CALL 123 : REM Builds the message to be sent
710 POP S
720 PUSH 123 : REM sets up call 29
730 CALL 29 : REM send the message
750 RETURN
760 REM *****      End Write parameter subroutine *****
```

DH-485 Messaging with a SLC5/03 Interface

The following example uses the DH-485 communications mode to send a message from an SLC5/03 to the Serial Communications Module.

Rung 2:0

If this is the first scan or the error bit is true, the MSG instruction's control byte is cleared and the done bit is set. This ensures that the program always starts correctly and recovers from a MSG error.

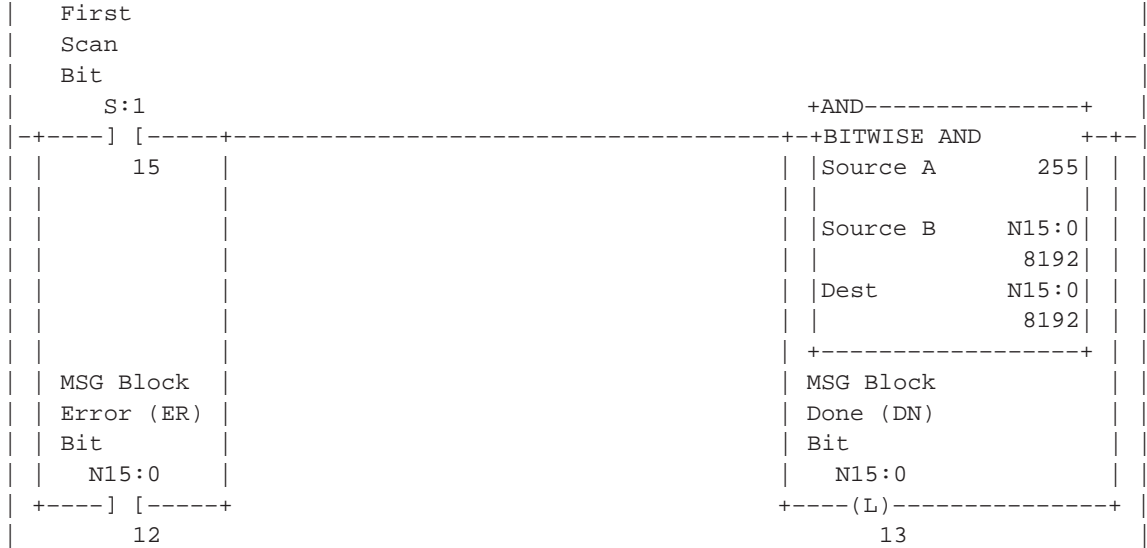

Rung 2:1

When the MSG instruction is done, the TON provides a 2 second delay before another message is sent. B3:0/0 represents user logic. The timer can be adjusted to provide control over DH485 network loading.



Rung 2:2

When the timer is done, the MSG instruction is enabled.

```

| TON Done -
| Enable
| MSG Block
|   T4:0
|-----] [-----+MSG-----+
|   DN                                     +READ/WRITE MESSAGE   +- (EN)-
|                                         |Type           PEER-TO-PEER+- (DN)
|                                         |Read/Write      WRITE+- (ER)
|                                         |Target Device   500CPU
|                                         |Local/Remote    LOCAL
|                                         |Control Block   N15:0
|                                         |Control Block Length 14
|                                         +-----+

```

Rung 2:3

```

|-----+END+-----

```

The following are the data tables used for this example:

Address	Data (Radix=BINARY)	Address	Data (Radix=BINARY)
B3:0	0000 0000 0000 0001		

Address	EN	TT	DN	TIME BASE	PRE	ACC
T4:0	1	1	0	.01 sec.	200	156

Address	CU	CD	DN	OV	UN	UA	PRE	ACC
C5:0	0	0	0	0	0	0	32767	2778

Address	Data (Radix=DECIMAL)
N10:0	7 6 0 0 0 0 0

Address	Data (Radix=DECIMAL)
N15:0	8192 3 9 10 137 5 0 224 10 0
N15:10	0 0 0 0

M0:1 File Length:64
M0:2 File Length:0
M0:3 File Length:0
M0:4 File Length:0

M1:1 File Length:64
M1:2 File Length:0
M1:3 File Length:0
M1:4 File Length:0

Block Transfer Emulation Instructions

Chapter Objectives

This chapter contains the header and data configurations that you need to set up the data files for the block transfer emulation instructions. The header and data values depend on the operation you want to perform.

Block Transfer Emulation Status Word

When an operation is unsuccessful, header word 2 of the drive response contains a negative value (bit 15 = 1).

In most cases, the drive also returns a status word to indicate the reason for the failure. The location of the status word is typically header word 4 in the drive response, but will depend on the message.

The following are valid status codes:

Value	Description
0	No error occurred.
1	The service failed due to an internal reason, and the drive could not perform the request (some messages are read only or write only).
2	The requested service is not supported.
3	An invalid value in the block transfer emulation request header word 2.
4	An invalid value in the block transfer emulation request header word 3.
5	An invalid value in the block transfer emulation request header word 2.
6	The data value is out of range.
7	There is a drive state conflict. The drive is in an incorrect state to perform the function. The drive cannot be running when you perform certain functions.

Scattered Parameter Value Read

The Scattered Parameter Value Read function reads a scattered list of parameters.

PLC Block Transfer Emulation Instruction Data

PLC request instruction length: 5-63 words

Drive response instruction length: 5-63 words

Message Structure

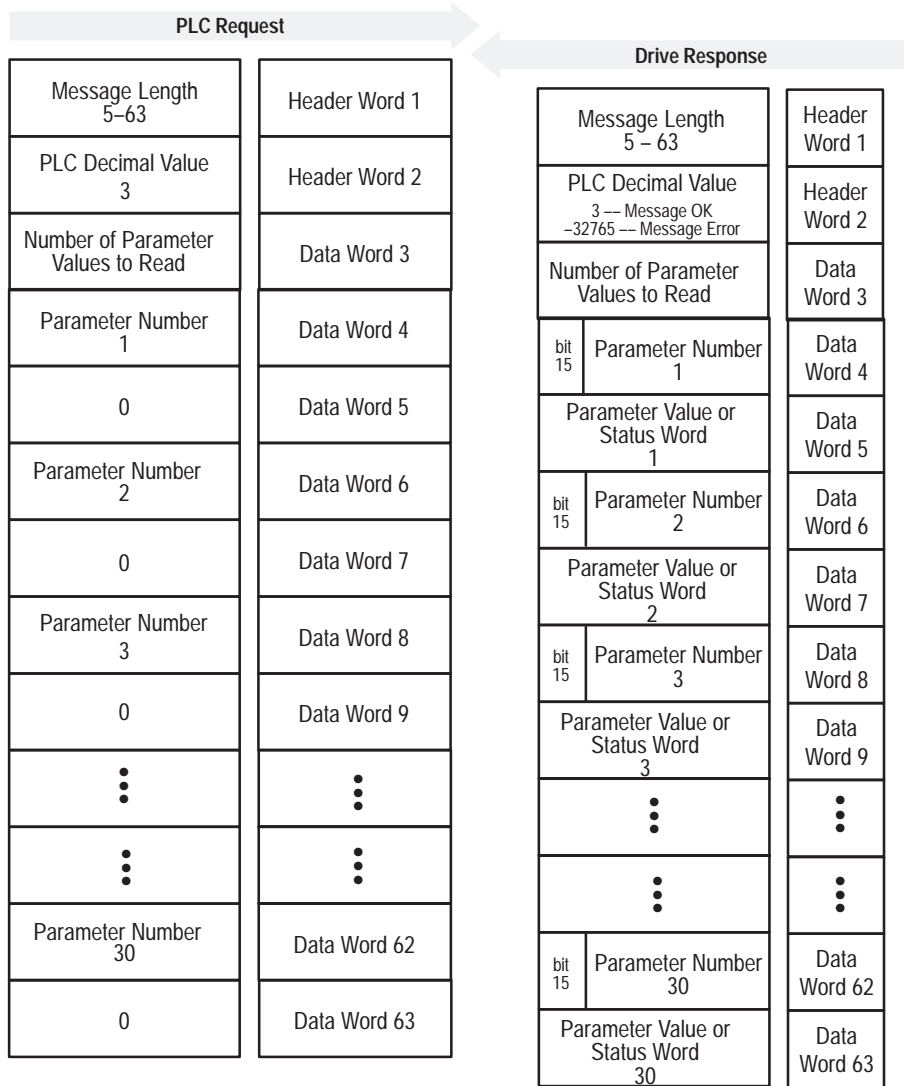

Message Operation

Scattered Parameter Value Read reads a pre-defined group of parameter values, in any order, from the device. You define the number of parameters to read in word 3 of the request. The parameters to be read and their order is defined starting with word 4. An unused word is left between each parameter request, so the drive can respond with the parameter value, as shown.

If an error has occurred in reading any of the parameters:

- Word 2 of the drive response returns a value of -32765 .
- Bit 15 of the drive response word for the number of that parameter is set.
- The drive response word for the value of that parameter returns a status word instead of returning the parameter value.

Example

In this example, eight parameters were read from a 1336 PLUS drive, as defined in word 3 of the request. The parameter numbers requested were 5, 7, 8, 20, 18, 17, 19, and 36. The drive response returned the values of these parameters in the data file. These values are in drive units.

Data File Format

		0	1	2	3	4	5	6	7	8	9
PLC request	N10:10	19	3	8*	5*	0	7*	0	8*	0	20*
	N10:20	0	18*	0*	17*	0	19*	0	36*	0	
Drive response	N10:90	19	3	8*	5*	6*	7*	1000*	8*	1000*	20*
	N10:100	4096*	18*	4096*	17*	51*	19*	60*	36*	6144*	

* Example only – These values vary depending on parameters and products.

Scattered Parameter Value Write

The Scattered Parameter Value Write function writes to a scattered list of parameters and returns the status of each parameter. If any of the states have errors, the parameter number is negative.

PLC Block Transfer Emulation Instruction Data

PLC request instruction length: 5-63 words

Drive response instruction length: 5-63 words

Message Structure

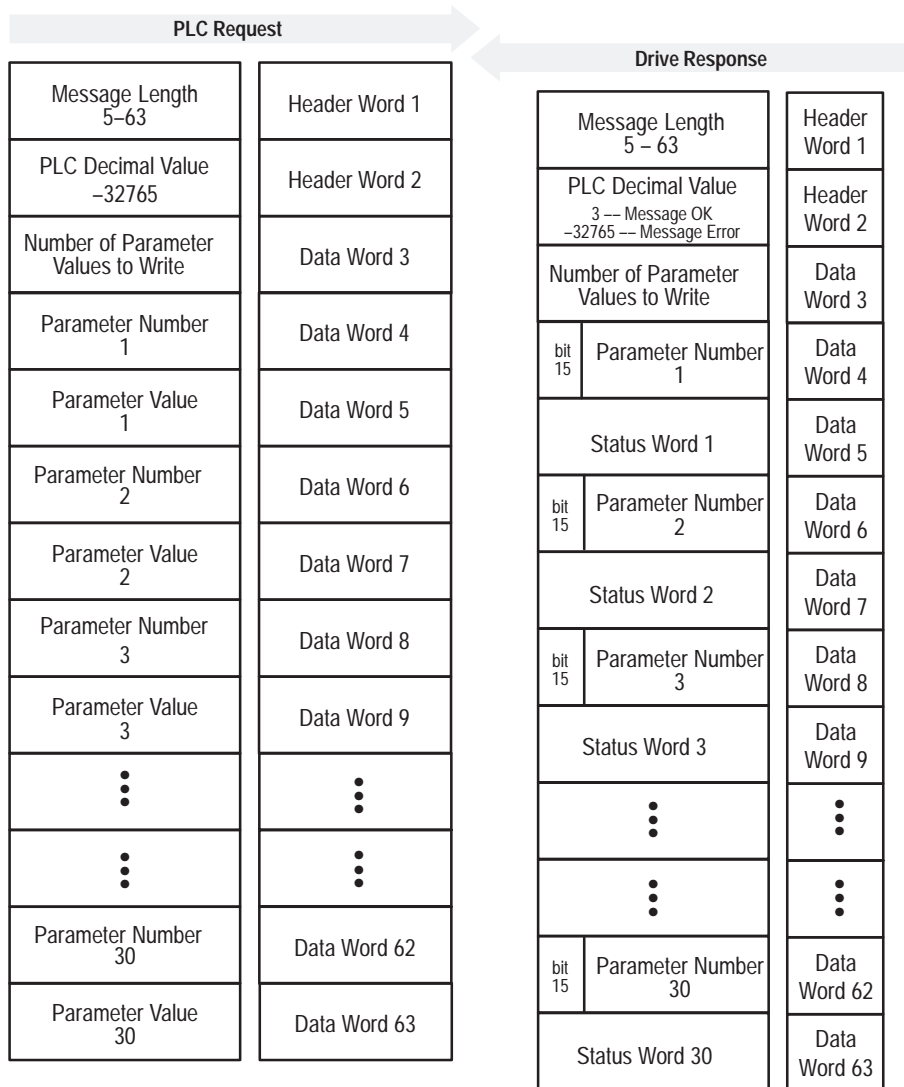

Message Operation

The Scattered Parameter Value Write function writes data values to a pre-defined group of device parameters in any order. You define the number of parameters to write in word 3. The parameters to be written to and their order is defined starting with word 4.

If an error occurs while writing to any of the parameters:

- Word 2 of the drive response returns a value of -32765 .
- Bit 15 of the drive response word for that parameter's number is set.
- The drive response word for that parameter's status word is non-zero.

If no error has occurred:

- Word 2 of the drive response returns a value of 3.
- Each of the drive response's parameter numbers are the same as in the request.
- Each of the drive response status words returns a value of 0.

Example

In this example, six parameters were written to in a 1336 PLUS drive. Word 3 of the request (N10:12) defines the number of parameter values that are transferred. Each parameter number followed by its value, are listed in the message beginning with word 4. The values are entered in device units.

The drive response (N10:90) returns the status of each parameter write. If the request was successful, a zero is returned. If an error has occurred, the response returns a status word code for the error.

Data File Format

		0	1	2	3	4	5	6	7	8	9
PLC request	N10:0	15	-32765	6*	90*	1*	150*	4*	30*	20*	31*
Drive response	N10:20	10*	10*	2*	12*	5*					
	N10:90	15	3	6*	90*	0*	150*	0*	30*	0*	31*
	N10:100	0*	10*	0*	12*	0*					

* Example only – These values vary depending on parameters and products.

Product ID Number Read

The Product ID Number Read function returns the product ID of the device to which the Serial Communications Module is connected.

PLC Block Transfer Emulation Instruction Data

PLC request instruction length: 3 words

Drive response instruction length: 4 words

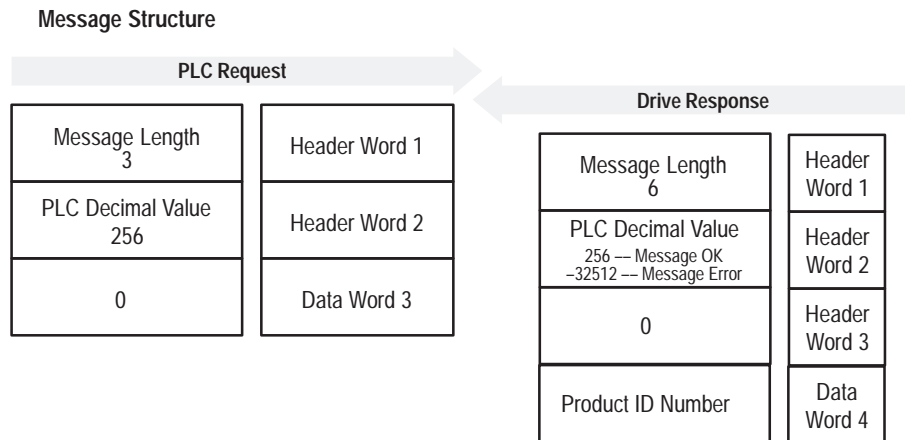

Product ID Number	Description
2	1336F (PLUS Fractional)
3	1336F (PLUS)
4	1336G (FIBERS Fractional)
5	1336G (FIBERS)
16	1336T (FORCE)
17	1395
18	1394
19	1557
20	SMP
21	SMC
22	1304
23	1305

Message Operation

The Product ID Number Read function, through the drive response message word 4, indicates the type of device the Serial Communications Module is connected to. This value is defined in the message response chart shown above.

If an error has occurred, word 2 of the response returns a negative value of -32512.

Example

In this example, the Product ID Number Read was requested. The drive response contained a value of 3 in word 4 of its message response, indicating a connection to a 1336 PLUS.

Data File Format

		0	1	2	3	4	5	6	7	8	9
PLC request	N10:0	3	256	0							
Drive response	N10:90	6	256	0	3*						

* Example only – These values vary depending on parameters and products.

Allen-Bradley Spares

Parameter Read Full

The Parameter Read Full function provides all known attributes for the parameters requested. This information includes the parameter's current value, descriptor, multiply and divide value, base value, offset value, text string, group element reference, minimum value, maximum value, default value, and unit text string.

PLC Block Transfer Emulation Instruction Data

PLC request instruction length: 3 words

Drive response instruction length: 20 words

Message Structure

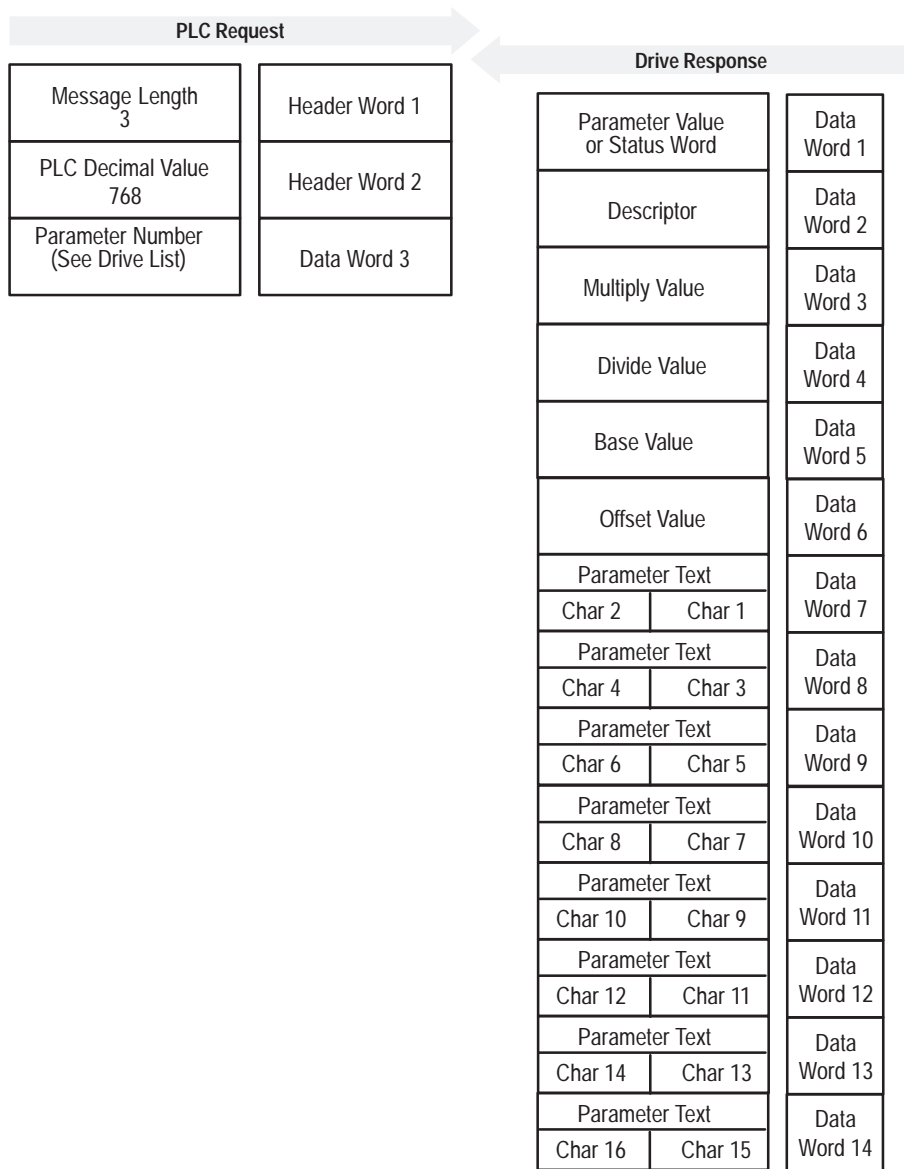

Message Structure (Continued)

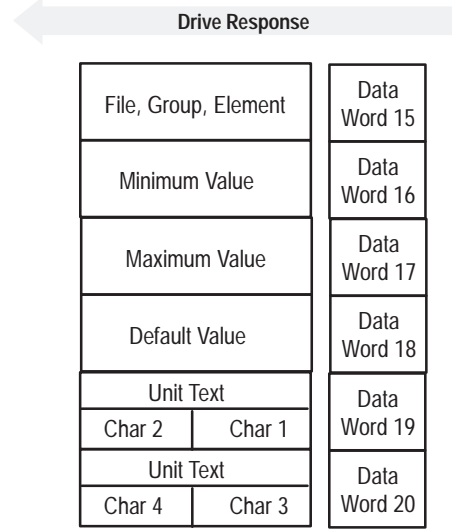

Message Operation

Parameter Read Full retrieves the attributes of the specified parameter. The attributes for each parameter include the data, minimum and maximum values, and the parameter text. The response message returns this information.

If an error has occurred in reading any of the values, word 1 contains the status word.

The parameter text is returned with each data word containing two ASCII characters per word. The first and second characters are in opposite order.

Example

In this example, a Parameter Read Full was performed through block transfer on a 1336 PLUS. N10:10 shows the header message for the request. The data is returned in the response data file, starting with word 1, for parameter 20. Word 1 shows the present value in drive units. Word 2 through word 6 provide scaling information, used to convert drive units to engineering units for the Human Interface Module (HIM). Word 7 through word 14 provide the parameter name.

This example shows the response message N10:90 through N10:112 in both binary and ASCII. Note the ASCII information beginning with N10:99. The parameter name characters return in reverse order for each word. N10:99 has the ASCII value of (aM). To read this, invert the word to read (Ma). The next word (ix), inverted gives you (xi). These words, along with the following two words, form the word *Maximum*. You can see the parameter name *Maximum Voltage* in word 7 through word 14 of the response message. In addition, word 20, is also returned in this format. This word provides the units the parameter is defined in. In this example it is *vlt*s.

Word 15 contains the file, group, and element which are used to reference the parameter.

Words 16–18 contain the minimum, maximum, and default values of this parameter.

Data File Format

		0	1	2	3	4	5	6	7	8	9
PLC request	N10:10	3	768	20*							
Drive response	N10:90	4096*	355*	1*	4096*	460*	0*	24909*	27000*	30061*	8301*
	N10:100	28502*	29804*	26465*	8293*	1794*	1024*	4915*	4096*	27734*	29556*
Drive response	N10:90#	\10\00	\01 c	\00\01	\10\00	\01\CC	\00\00	a M	i x	u m	m
	N10:100#	o V	t l	g a	e	07 02	04 00	\13 0	\10\00	l V	s t

* Example only – These values vary depending on parameters and products.

ASCII Display values

Parameter Value Read

The Parameter Value Read function reads the 16-bit parameter data value for the selected parameter number.

PLC Block Transfer Emulation Instruction Data

PLC request instruction length: 3 words

Drive response instruction length: 1 word

Message Structure

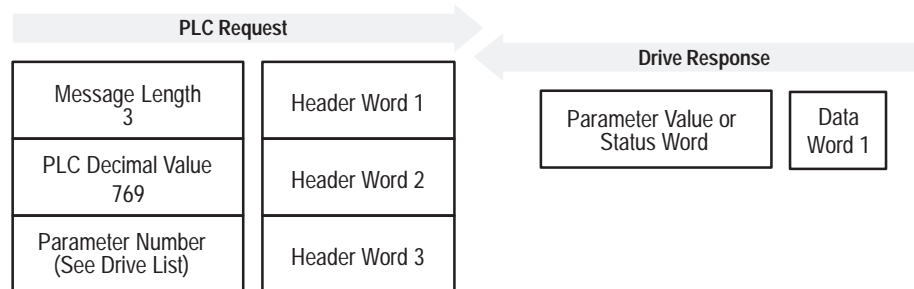

Message Operation

Parameter Value Read reads parameter values from the drive and places that value (or an error code) in word 1 of the drive response data file. The value is shown in device units. Device units are listed in the user manual for the device you are using.

If an error occurs:

- Word 1 of the response contains the status code.
- The status area of the data file is non-zero.

Example

In this example, the value of parameter 20 was requested from a 1336 PLUS and a value of 4096 was returned. 4096 is the internal drive unit value for the *Maximum Rated Voltage* Parameter. This corresponds to a value of 100% Drive Rated Volts in Display Units.

Data File Format

		0	1	2	3	4	5	6	7	8	9
PLC request	N10:10	3	769	20*							
Drive response	N10:90	4096*									

* Example only – These values vary depending on parameters and products.

Allen-Bradley Spares

Parameter Value Write

The Parameter Value Write message writes a 16-bit parameter data value to the selected parameter number.

PLC Block Transfer Emulation Instruction Data

PLC request instruction length: 1 word

Drive response instruction length: 4 words

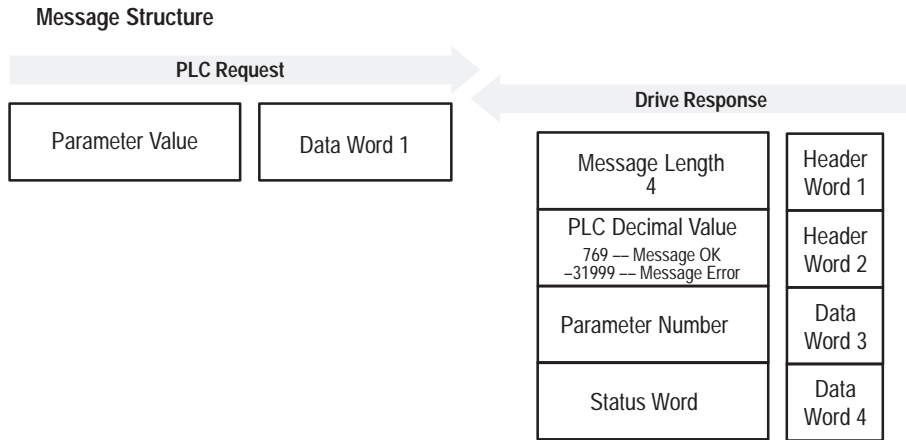

Message Operation

The Parameter Value Write function sends a new value to the specified parameter. The value must be in device units. Units for each parameter are listed in the device manual.

If an error has occurred, word 2 of the response returns a value of -31999, and word 4 contains a status code.

Example

In this example, a value of 4096 was sent to Parameter 20. 4096 is in drive units and indicates a value of 100% Drive Rated Volts, as defined in P147, *Drive Rated Volts*.

Data File Format

		0	1	2	3	4	5	6	7	8	9
PLC request	N10:0	4	-31999	20*	4096*						
Drive response	N10:90	4	769	20*	0						

* Example only – These values vary depending on parameters and products.

EE Memory Functions

The EE Memory Functions message activates the specified EE functions.

PLC Block Transfer Emulation Instruction Data

PLC request instruction length: 4 words

Drive response instruction length: 3 words

Message Structure

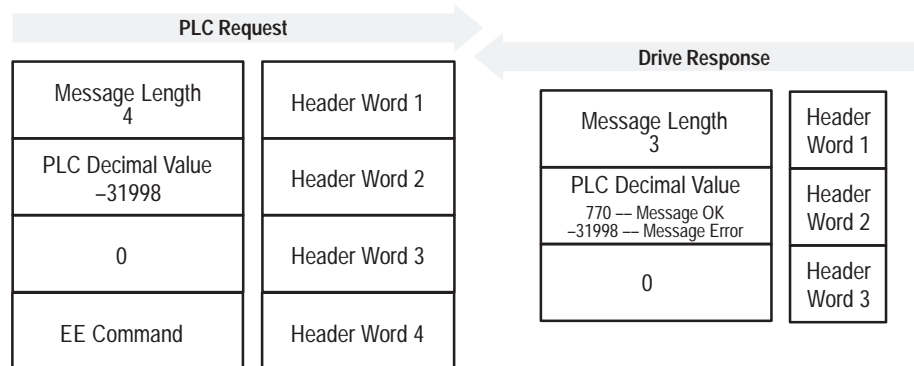

Value	EE Command
00	Not Used
01	EE Save
02	EE Recall
03	EE Default Initialize

Message Operation

The EE memory function allows three different message requests:

- EE Save saves parameter information from the working memory or RAM to EEPROM.
- EE Recall retrieves the last saved data from EEPROM and places it in the working memory or RAM.
- EE Default Initialize clears the RAM and EEPROM and sets all parameter values to default.

If an error has occurred, word 2 of the response returns a value of -31998.

Example

This example requests that an EEPROM Save function be performed.

Data File Format

		0	1	2	3	4	5	6	7	8	9
PLC request	N10:10	4	-31998	0*	1*						
Drive response	N10:90	3	770	0*							

* Example only – These values vary depending on parameters and products.

Fault Clear/Reset

The Fault Clear/Reset message activates the Clear Fault, Clear Fault Queue, and Drive Reset functions.

PLC Block Transfer Emulation Instruction Data

PLC request instruction length: 4 words

Drive response instruction length: 4 words

Message Structure

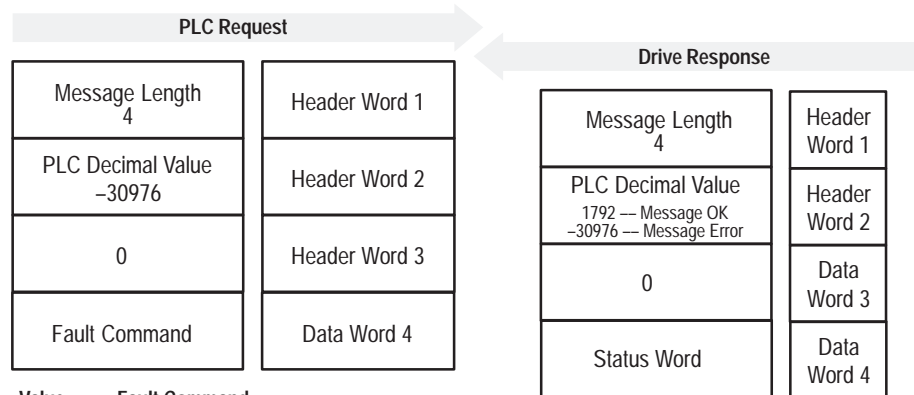

Value	Fault Command
00	Not Used
01	Clear Fault
02	Clear Fault Queue
03	Drive Reset (1336 FORCE Only)

Message Operation

The specified fault Clear/Reset function sends a fault handling request to the device.

- A Clear Fault request clears the last fault that occurred.
- A Clear Fault Queue clears the entire fault buffer. Certain devices may store more than one fault.
- A Drive Reset is used with the 1336 FORCE drive product only. This function resets the drive; it clears the fault queue and writes the parameter information stored in EEPROM to RAM.

Data File Format

	0	1	2	3	4	5	6	7	8	9
PLC request	N10:0	4	-30976	0	1,2,3					
Drive response	N90:0	4	1792	0	0*					

* Example only – These values vary depending on parameters and products.

Allen-Bradley Spares

Fault Queue Entry Read Full

This function reads the contents of the specified fault queue entry. A message is returned which includes the fault text and fault code associated with the specified fault queue entry. The 1336 FORCE also returns the time stamp associated with the fault.

PLC Block Transfer Emulation Instruction Data

PLC request instruction length: 3 words

Drive response instruction length: 12 or 16 words

Message Structure

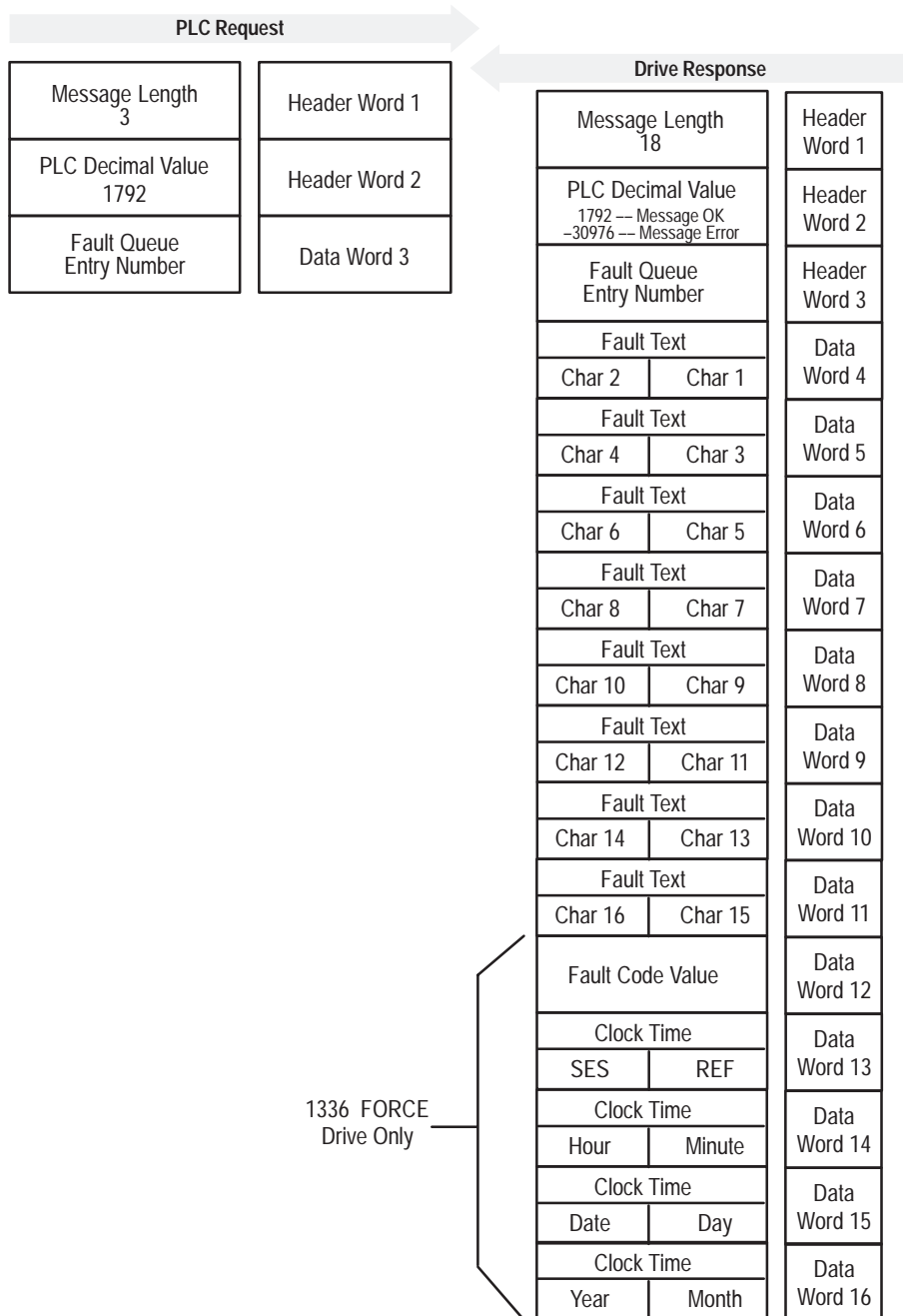

Message Operation

Fault Queue Entry Read Full reads the contents of the fault queue specified in word 3 of the request. The response returns the fault text which can be ASCII text. The text will have every two characters in reverse order. In addition, the 1336 FORCE returns a time stamp, indicating the day and time the fault occurred.

If an error has occurred, word 2 of the response returns a negative value.

Example

In this example, Fault Queue Entry number 3 was retrieved from a 1336 PLUS drive. The drive response returned the ASCII text *Drive Reset Flt*, with each character reversed. The fault code for this example is 22.

Data File Format

		0	1	2	3	4	5	6	7	8	9
PLC request	N10:0	3	1792	3*							
Drive response	N10:90	18	1792	3*	29252*	30313*	8293*	25938*	25971*	8308*	27718*
	N10:100	8308*	22*								
	N10:90#	\00\12	\07\00	\03\00	r D	v i	e e	R e	s t	l F	
	N10:100#	t	\00\16								

* Example only – These values vary depending on parameters and products.

ASCII Display values

Fault Queue Size

The Fault Queue Size function gets the number of fault entries allowed in the fault queue.

PLC Block Transfer Emulation Instruction Data

PLC request instruction length: 3 words

Drive response instruction length: 4 words

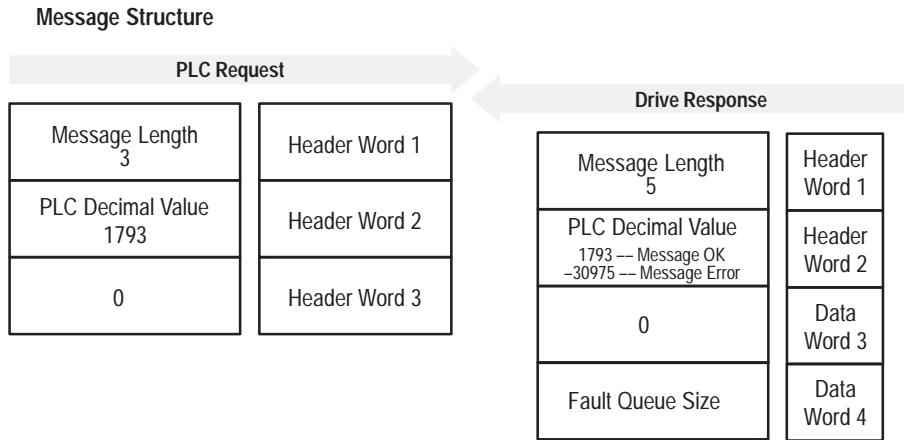

Message Operation

The Fault Queue Size function reads back the size of the fault queue available in the product. Each product may have a different number of fault queue entries available for storage.

If an error has occurred, word 2 of the response returns a value of -30975.

Example

In this example, a 1336 PLUS was used. This product has a fault queue of four storage locations available to store faults. This value is seen in word 4 of the response header message.

Data File Format

		0	1	2	3	4	5	6	7	8	9
PLC request	N10:0	3	1793	0							
Drive response	N10:90	6	1793	0	4*						

* Example only – These values vary depending on parameters and products.

Trip Fault Queue Number

The Trip Fault Queue Number provides the fault queue number of the fault that caused the device to trip.

PLC Block Transfer Emulation Instruction Data

PLC request instruction length: 3 words

Drive response instruction length: 4 words

Message Structure

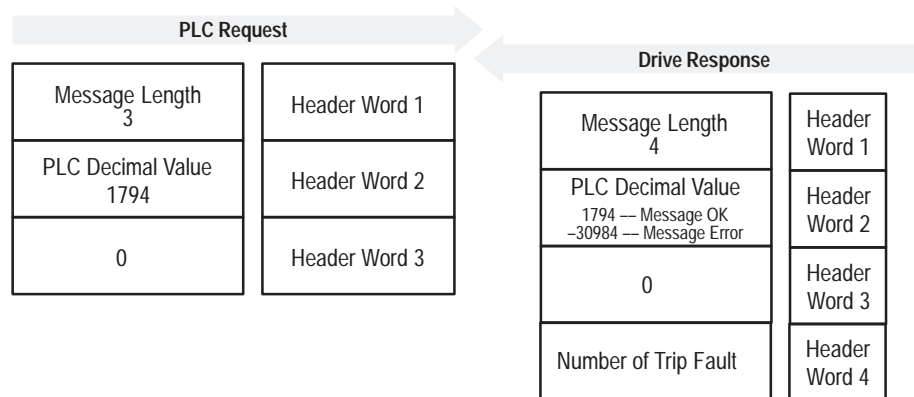

Message Operation

The Trip Fault Queue Number function provides the number of the entry in the fault queue that tripped the device in word 4 of the drive response. The Fault Queue Number is 0 when the device is not faulted.

If an error has occurred in the block transfer, word 2 of the response is negative.

Example

In this example, the device has stored a fault in the first entry of the Fault Queue that caused the drive to trip. Word 4 of the response indicates the entry number.

Data File Format

		0	1	2	3	4	5	6	7	8	9
PLC request	N10:0	3	1794	0							
Drive response	N10:90	6	1794	0	1*						

* Example only – These values vary depending on parameters and products.

Allen-Bradley Spares

Troubleshooting

Chapter Objectives

Use this chapter to help you troubleshoot your Serial Communications Module system using the LED indicators on the front of the device (as shown below). The Serial Communications Module is a non-serviceable device that you should return to Allen-Bradley for replacement when a major fault exists that is attributable to the Serial Communications Module itself.

LED Locations

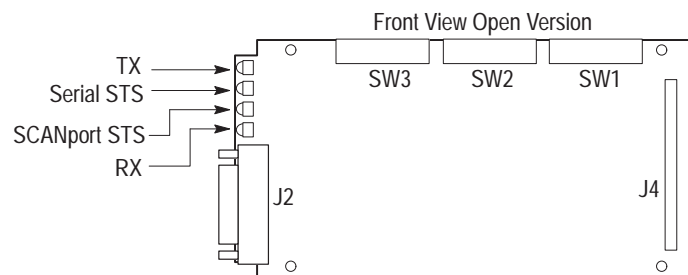

Front View Enclosed Version

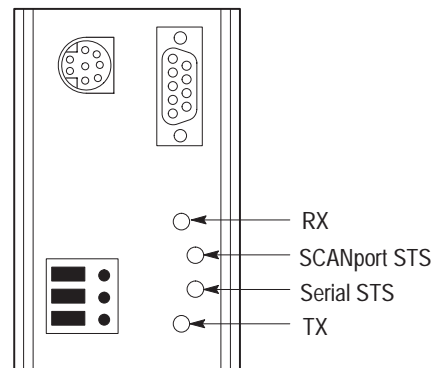

AB0414C



ATTENTION: Servicing energized industrial control equipment can be hazardous. Electrical shock, burns, or unintentional actuation of controlled industrial equipment may cause death or serious injury. Follow the safety-related practices of NFPA 70E, Electrical Safety for Employee Workplaces, when working on or near energized equipment. Do not work alone on energized equipment.



ATTENTION: Do not attempt to defeat or override fault circuits. You must determine and correct the cause of a fault indication before attempting operation. Failure to correct a drive or system malfunction may result in personal injury and/or equipment damage due to uncontrolled machine system operation.

LED Troubleshooting Table

Indicator	Color	Description	Recommended Action
Serial Sts	Green (blinking)	Link OK, off-line	<ul style="list-style-type: none"> • Check configuration switch settings. • Check for serial cable connection. • Cycle Serial Communications Module power.
	Green (steady)	Link OK, on-line	None, system functioning properly
	Red (blinking)	Link was on-line and is now off-line	Check for failed devices or link problems.
	Red (steady)	Faulted	<ul style="list-style-type: none"> • Check configuration switch settings. • Check for serial cable connection. • Cycle power, replace module.
SCANport Sts	Green (blinking)	Link OK, not connected	<ul style="list-style-type: none"> • Check configuration switch settings. • Check for serial cable connection. • Cycle power.
	Green (steady)	Link OK, connected	None
	Red (blinking)	Link was connected and is now not connected	Check for failed devices or link problems.
	Red (steady)	Faulted	<ul style="list-style-type: none"> • Check configuration switch settings. • Check for serial cable connection. • Cycle power, replace module.
TX	Off	No transmission occurring	• Send serial data again
	Flash	Transmission occurring	None
RX	Off	No transmission received	• Check data device to verify it is sending data
	Flash	Characters being received	None

Specifications

Chapter Objectives

This chapter provides you with background information and specifications that you may need to install or apply your Serial Communications Module.

Product Specifications

	Open Style	Enclosed Style 115/230V AC	Enclosed Style 24V DC
Catalog Number:	-GM2	-GD2	-GK2
Environmental:			
Operating Temperature	0 to 50° C (32 to 122°F)	0 to 50° C (32 to 122°F)	0 to 50° C (32 to 122°F)
Storage Temperature	-40 to 85° C (-40 to 185°F)	-40 to 85° C (-40 to 185°F)	-40 to 85° C (-40 to 185°F)
Electrical:			
Input Voltage	Supplied by drive	85 to 264V AC, 1 phase	24V DC, ±10%
Input Frequency	NA	45 to 63 Hz	NA
Input Current	NA	35mA maximum	0.4 amps maximum
SCANport Load	60mA DC	60mA DC	60mA DC
Communications:			
SCANport Side	SCANport Peripheral Interface	SCANport Peripheral Interface	SCANport Peripheral Interface
Serial Side	RS-232/RS-422/RS-485 (DF1) DH-485	RS-232/RS-422/RS-485 (DF1) DH-485	RS-232/RS-422/RS-485 (DF1) DH-485
Baud Rates	110, 300, 600, 1200, 2400, 4800, 9600, 19.2K	110, 300, 600, 1200, 2400, 4800, 9600, 19.2K	110, 300, 600, 1200, 2400, 4800, 9600, 19.2K
Checksum	BCC or CRC	BCC or CRC	BCC or CRC
Dimensions:			
	Open (IP00)	NEMA Type 1 (IP30)	NEMA Type 1 (IP30)
	NA	45w x 76h x 123d mm (1.8 x 3.0 x 4.8 in.)	45w x 76h x 123d mm (1.8 x 3.0 x 4.8 in.)

Module Compatibility

This module is intended for use with devices that communicate via RS-232, RS-422, or RS-485 hardware standards using the DF1 protocol or the DH-485 standard. The Serial Communications Module is intended to provide a means for transmitting messages between these serial communications devices and Allen-Bradley SCANport devices.



Allen-Bradley, a Rockwell Automation Business, has been helping its customers improve productivity and quality for more than 90 years. We design, manufacture and support a broad range of automation products worldwide. They include logic processors, power and motion control devices, operator interfaces, sensors and a variety of software. Rockwell is one of the worlds leading technology companies.

Worldwide representation.



Argentina • Australia • Austria • Bahrain • Belgium • Brazil • Bulgaria • Canada • Chile • China, PRC • Colombia • Costa Rica • Croatia • Cyprus • Czech Republic • Denmark • Ecuador • Egypt • El Salvador • Finland • France • Germany • Greece • Guatemala • Honduras • Hong Kong • Hungary • Iceland • India • Indonesia • Ireland • Israel • Italy • Jamaica • Japan • Jordan • Korea • Kuwait • Lebanon • Malaysia • Mexico • Netherlands • New Zealand • Norway • Pakistan • Peru • Philippines • Poland • Portugal • Puerto Rico • Qatar • Romania • Russia-CIS • Saudi Arabia • Singapore • Slovakia • Slovenia • South Africa, Republic • Spain • Sweden • Switzerland • Taiwan • Thailand • Turkey • United Arab Emirates • United Kingdom • United States • Uruguay • Venezuela • Yugoslavia

Allen-Bradley Headquarters, 1201 South Second Street, Milwaukee, WI 53204 USA, Tel: (1) 414 382-2000 Fax: (1) 414 382-4444

Allen-Bradley Spares