



***Allen-Bradley***

***1302 AC Drive  
(575V AC)***

***Version 3.1***

# **User Manual**

**Spare Allen-Bradley Parts**

## Important User Information

Solid state equipment has operational characteristics differing from those of electromechanical equipment. “Safety Guidelines for the Application, Installation and Maintenance of Solid State Controls” (Publication SGI-1.1) describes some important differences between solid state equipment and hard-wired electromechanical devices. Because of this difference, and also because of the wide variety of uses for solid state equipment, all persons responsible for applying this equipment must satisfy themselves that each intended application of this equipment is acceptable.

In no event will the Allen-Bradley Company be responsible or liable for indirect or consequential damages resulting from the use or application of this equipment.

The examples and diagrams in this manual are included solely for illustrative purposes. Because of the many variables and requirements associated with any particular installation, the Allen-Bradley Company cannot assume responsibility or liability for actual use based on the examples and diagrams.

No patent liability is assumed by Allen-Bradley Company with respect to use of information, circuits, equipment, or software described in this manual.

Reproduction of the contents of this manual, in whole or in part, without written permission of the Allen-Bradley Company is prohibited.

Throughout this manual we use notes to make you aware of safety considerations.



**ATTENTION:** Identifies information about practices or circumstances that can lead to personal injury or death, property damage, or economic loss.

---

Attentions help you:

- identify a hazard
- avoid the hazard
- recognize the consequences

**Important:** Identifies information that is especially important for successful application and understanding of the product.

# Table of Contents

---

<b>Introduction</b>	<b>Chapter 1</b>	
	Manual Objectives . . . . .	1-1
<b>Drive Description</b>	<b>Chapter 2</b>	
	Introduction . . . . .	2-1
	Standard Features . . . . .	2-1
	Drive Description . . . . .	2-2
	System Diagram . . . . .	2-3
	Model Numbers . . . . .	2-6
	Enclosure Ratings . . . . .	2-7
	Component Locations . . . . .	2-7
	Option Kits . . . . .	2-7
<b>Preinstallation</b>	<b>Chapter 3</b>	
	General . . . . .	3-1
	Site Requirements . . . . .	3-2
	Cooling Airflow . . . . .	3-4
	Wiring Requirements . . . . .	3-4
	Input Fusing . . . . .	3-7
	Emergency Stop Installation . . . . .	3-8
	Motor Considerations . . . . .	3-9
<b>Installation</b>	<b>Chapter 4</b>	
	Introduction . . . . .	4-1
	Mounting the Drive . . . . .	4-1
	Routing Wires . . . . .	4-1
	External Component Installation . . . . .	4-4
	Setting the Analog Input Jumper on the Regulator Board . . . . .	4-6
	Motor Preparation . . . . .	4-5
<b>Drive Wiring</b>	<b>Chapter 5</b>	
	Introduction . . . . .	5-1
	Signal and Control Wiring . . . . .	5-3
	Digital Input Wiring . . . . .	5-4
	Output Power Wiring . . . . .	5-10
	Grounding . . . . .	5-10

# Spare Allen-Bradley Parts

<b>Final Installation Checks</b>	<b>Chapter 6</b>	
	Introduction . . . . .	6-1
	Power Off Checks . . . . .	6-1
	Operational Checks . . . . .	6-3
<b>Display and Keypad Operation</b>	<b>Chapter 7</b>	
	Introduction . . . . .	7-1
	Display Description . . . . .	7-1
	Key Description . . . . .	7-2
	LED Descriptions . . . . .	7-3
	Program Mode . . . . .	7-4
	Monitor Mode . . . . .	7-6
	Drive Control . . . . .	7-8
<b>Programming</b>	<b>Chapter 8</b>	
	Introduction . . . . .	8-1
	Program Security . . . . .	8-2
	Parameter Descriptions . . . . .	8-4
<b>Troubleshooting</b>	<b>Chapter 9</b>	
	Introduction . . . . .	9-1
	Verifying DC Bus Voltage . . . . .	9-1
	Troubleshooting the Drive Using Fault Codes . . . . .	9-2
	Accessing and Clearing the Error Log . . . . .	9-5
	Power Module Check . . . . .	9-7
<b>Technical Specifications</b>	<b>Appendix A</b>	
	Service Conditions . . . . .	A-1
	Dimensions . . . . .	A-1
	Environmental Conditions . . . . .	A-1
	Drive Inputs . . . . .	A-2
	Drive Outputs . . . . .	A-2
<b>User Settings Record</b>	<b>Appendix B</b>	
	Parameter Table . . . . .	B-1
<b>Alphabetical Parameter Listing</b>	<b>Appendix C</b>	
	Parameter List . . . . .	C-1
<b>Replacement Parts</b>	<b>Appendix D</b>	
	Parts Table . . . . .	D-1

## Introduction

### Manual Objectives

The purpose of this manual is to provide you with the necessary information to install, program, start up and maintain the 1302 AC Drive. This manual should be read in its entirety before operating, servicing or initializing the 1302 Drive.

This manual is intended for qualified electrical personnel responsible for installing, programming, starting up, and maintaining the 1302 drive.

This manual describes how to install and troubleshoot the 1302 AC drive. Drive installation consists of the following basic tasks:

- Plan your installation using the guidelines presented in chapter 3. If your installation must be in compliance with Electromagnetic Compatibility Standards, read Appendix E also.
- Mount the Drive and install external components according to the guidelines presented in chapter 4.
- Wire the Drive's input power, output power, and control signal terminal strip using the instructions in chapter 5.
- Adjust parameter values, if required. The parameters are described in chapter 8. For quick reference, the factory-set values are listed in Appendix B.
- Perform the power-off and power-on checks described in chapter 6 to complete the installation.

If problems occur during Drive operation, refer to chapter 9.

Appendix F lists the parts of the Drive that can be replaced. Before you begin the installation procedure, become familiar with the Drive by reading chapter 2, which provides an overview of the Drive and its features, chapter 7, which describes the operation of the keypad and the display, and Appendix A, which lists the Drive's technical specifications.

# Spare Allen-Bradley Parts



**ATTENTION:** Only qualified electrical personnel familiar with the construction and operation of this equipment and the hazards involved should install, adjust, operate and/or service this equipment. Read and understand this section in its entirety before proceeding. Failure to observe this precaution could result in bodily injury or loss of life.

**ATTENTION:** An incorrectly installed or applied Drive can result in component damage or a reduction in product life. Wiring or application errors such as undersizing the motor, incorrect or inadequate AC supply or excessive ambient temperatures may result in damage to the Drive or motor.

**ATTENTION:** This Drive contains ESD (Electrostatic Discharge) sensitive parts and assemblies. Static control precautions are required when installing, testing, servicing or repairing this assembly. Component damage may result if ESD control procedures are not followed. If you are not familiar with static control procedures, reference Allen-Bradley Publication 8000 – 4.5.2, *Guarding against Electrostatic Damage* or any other applicable ESD protection handbook.

---

## 1302 AC Drive Description

### Introduction

This chapter describes the 1302 Drive and how to identify it based on its model number. This chapter also provides power and enclosure rating information.

### Standard Features

The 1302 Drive has the following features:

- On-board keypad and display providing:
  - Start/Stop/Reset control
  - Forward/Reverse (reverse-disable selectable)
  - Setpoint adjustment, Motor RPM, %load, or output voltage display
  - Drive diagnostics
- 500 millisecond power dip ride-through
- 150% overload for one minute
- 0.5 to 240 Hz three-phase voltage output
- NEMA 1 and NEMA 4/12 enclosures
- A snubber resistor braking signal and a scaled voltage analog output (0 to 10 VDC) which is proportional to:
  - Output frequency
  - Output amps
  - Output voltage
  - Selected reference
- Quiet motor operation with high carrier frequency selection
- Drive protection:
  - Overcurrent
  - Short circuit
  - Ground fault
  - Overvoltage
  - Undervoltage
  - Overtemperature
- UL/CSA electronic overload that meets NEC/CEC requirements
- User-selectable relay contact for indications of Drive running, Drive faulted, or Drive at selected speed
- User-selectable power-up start, auto-restart, and coast-to-rest or ramp-to-rest stop functions
- User-selectable local or remote operation
- 29 user-adjustable software parameters

# Spare Allen-Bradley Parts

## Drive Description

The 1302 Drive is an AC PWM (pulse-width-modulated) inverter that operates on single- or three-phase power as detailed in Figures 2.1 and 2.2. AC input power is applied to the Drive's input terminals. Voltage transients are suppressed by three metal-oxide-varistor (MOV) suppressors. These suppressors keep any input voltage transients within the maximum voltage rating of the input diode module.

The input diode module rectifies the incoming AC voltage into a constant DC bus voltage which is filtered by the DC bus capacitor bank. An internal DC-to-DC power supply uses power from the DC bus and provides the necessary voltages required by the Drive. Under regulator software control, the IGBT (insulated-gate bipolar-transistor) inverter bridge converts the constant DC voltage into an AC PWM waveform. The regulator switches the IGBT inverter bridge using a 4, 6, or 8 kHz carrier frequency (user-selectable). A low carrier frequency maximizes the power rating of the Drive but also increases acoustic noise. A high carrier frequency selection reduces acoustic noise but results in a derating of the Drive's efficiency.

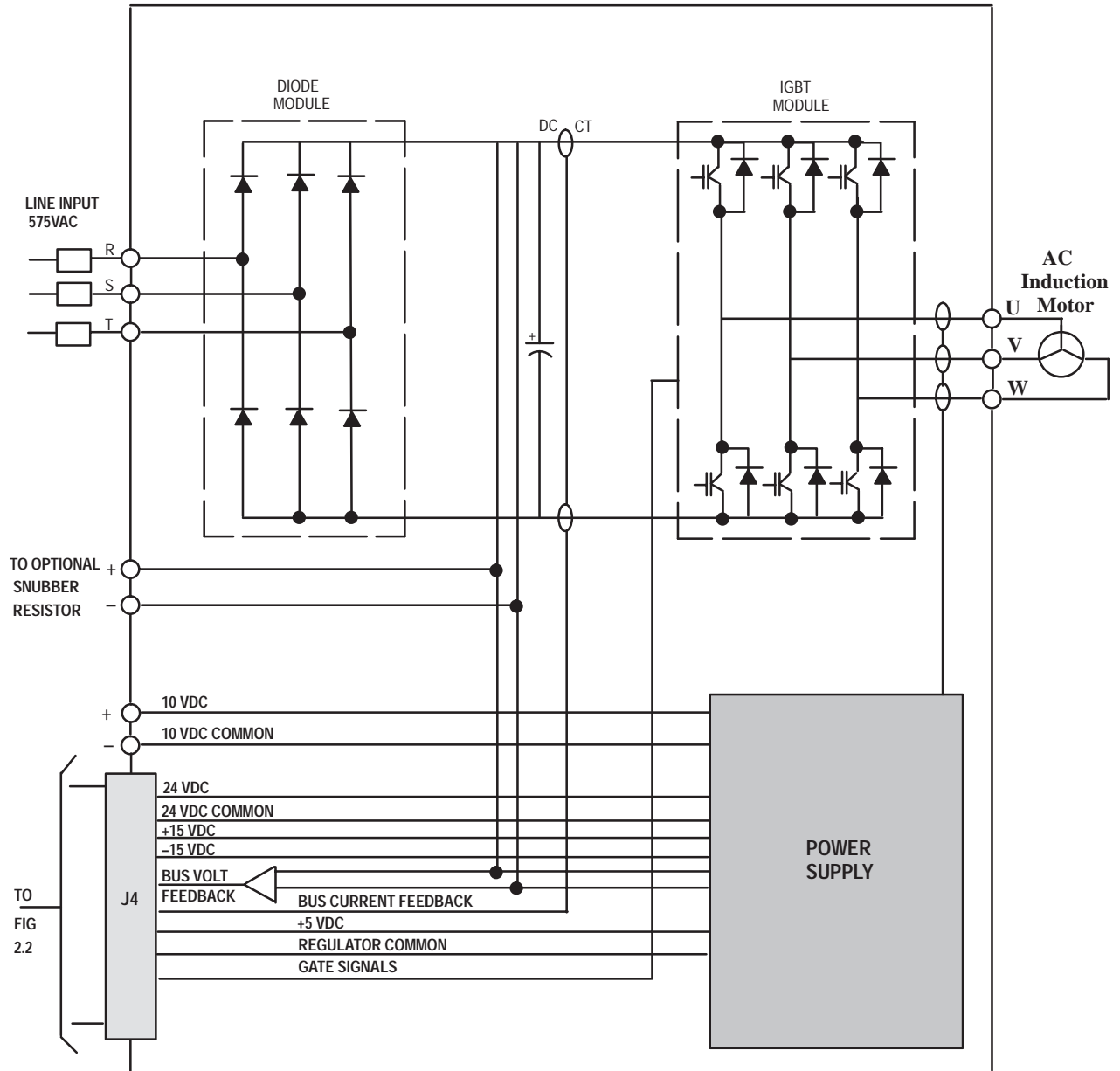
The volts per hertz (V/Hz) regulator governs the open-loop operation of the Drive for adjustable speed performance of AC induction and synchronous motors. The regulator maintains a ratio of voltage to output frequency that provides constant or variable torque across a wide speed range. Drive operation can be adjusted by the parameters entered through the keypad. A microprocessor on the Regulator board controls Drive regulation. See Figure 2.3. The Regulator board accepts internal power feedback signals and an external speed reference signal. The Regulator board provides display data for a four-character display, which is used to indicate Drive parameters, parameter values, and fault codes.

The Drive can be controlled either locally through the keyboard and display (see Chapter 7) or remotely through the terminal strip (see Chapter 5).

The Drive is intended to operate trip-free under any condition. The Drive uses selected signals to extend the acceleration (starting) and deceleration (stopping) rates of the motor when an overcurrent condition occurs. When a fault does occur, however, the regulator generates an instantaneous electronic trip (IET) signal to turn the Drive off (coast-to-rest). The Drive stores an indication or record of the IET fault, which can be viewed on the four-character display. After a fault, the STOP/RESET key or a user-supplied IET RESET pushbutton must be pressed to reset the IET signal and clear the fault from the Drive.

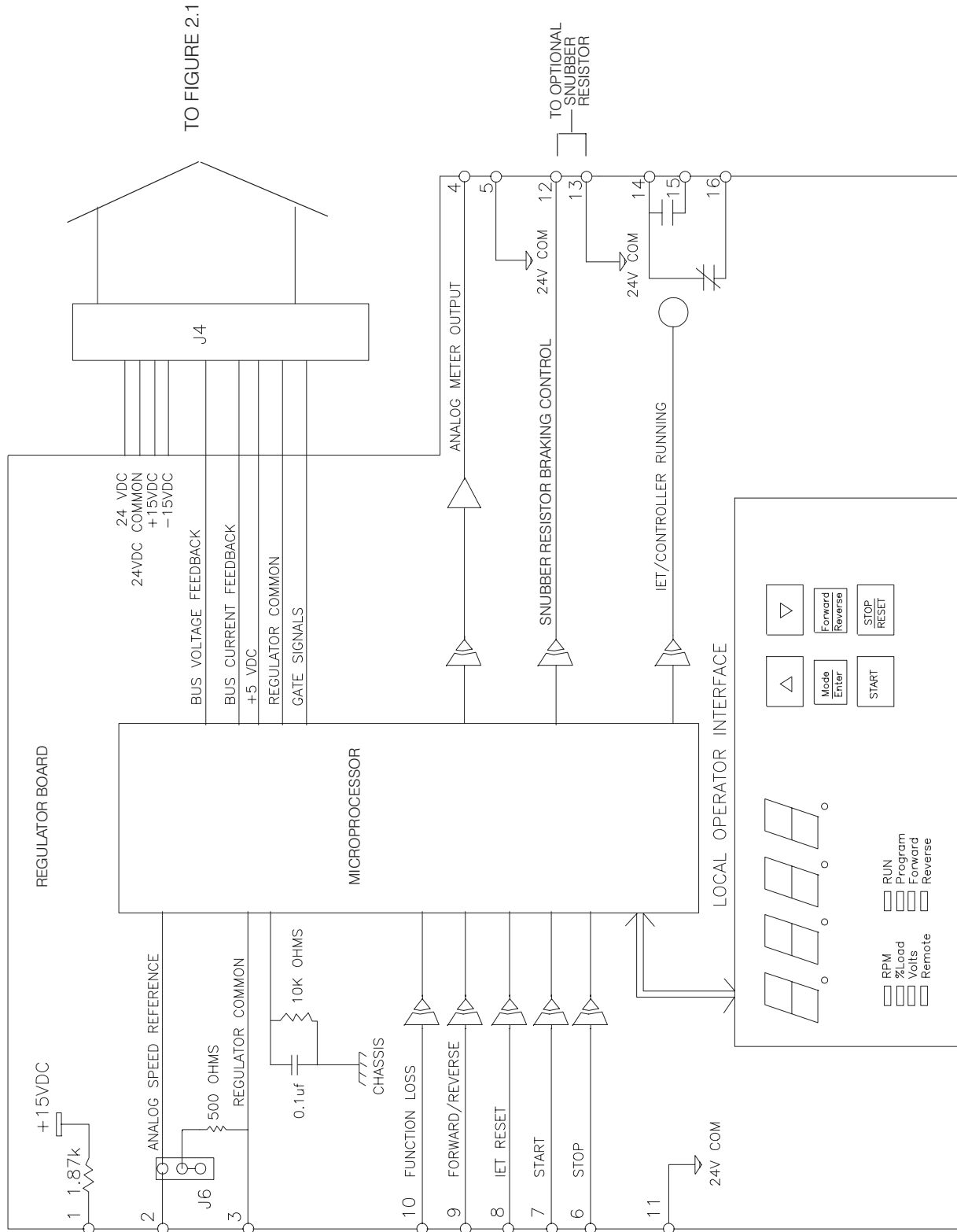


Figure 2.1  
1302 System Diagram

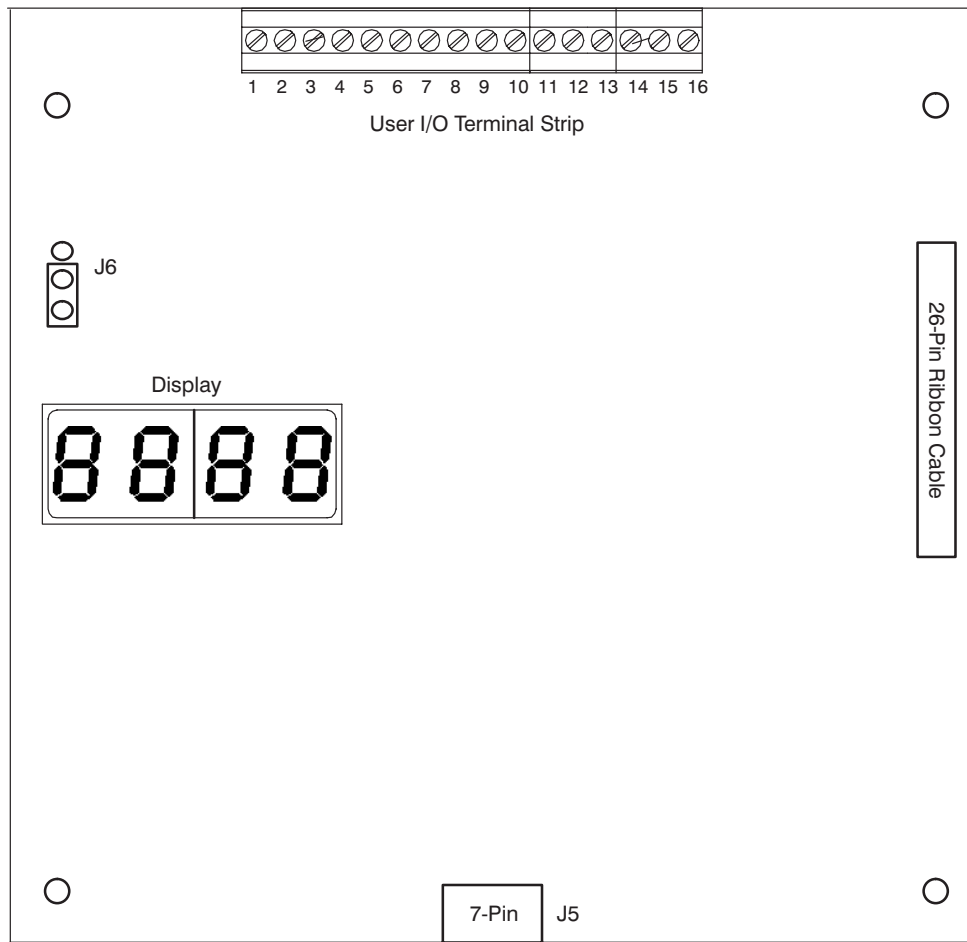


Spare Allen-Bradley Parts

Figure 2.2  
1302 System Diagram Cont.



**Figure 2.3**  
**Regulator Board Component Locations**



Spare Allen-Bradley Parts

## Model Numbers

A model number identifies each 1302 AC Drive as detailed in Table 2.A. This number appears on the shipping label and on the Drive's nameplate located on the right side of the Drive housing. The Drive's model number contains codes that indicate: input voltage range, enclosure rating, and horsepower rating. Drive enclosure ratings are detailed later in this chapter. All 1302 Drives described in this instruction manual function in the same manner.

**Table 2.A - Power and NEMA Enclosure Ratings**

Model Number	Input Voltage	Horsepower	Enclosure Size	NEMA Rating	Input Amps	Input KVA	Output Amps*	Power Loss Watts**
1302-C001-AA	575 VAC	1	B	1	2.0	2.0	1.6	50
1302-C001-AF	575 VAC	1	B	4X/12	2.0	2.0	1.6	50
1302-C002-AA	575 VAC	2	B	1	3.4	3.3	2.7	90
1302-C002-AF	575 VAC	2	B	4X/12	3.4	3.3	2.7	90
1302-C003-AA	575 VAC	3	B	1	5.2	5.1	4.3	120
1302-C003-AF	575 VAC	3	B	4X/12	5.2	5.1	4.3	120
1302-C005-AA	575 VAC	5	B	1	7.5	7.5	6.2	150
1302-C005-AF	575 VAC	5	B	4X/12	7.5	7.5	6.2	150
1302-C007-AA	575 VAC	7.5	C	1	10.9	10.9	9.0	180
1302-C007-AF	575 VAC	7.5	C	4X/12	10.9	10.9	9.0	180
1302-C010-AA	575 VAC	10	C	1	14.5	14.4	12.0	250
1302-C010-AF	575 VAC	10	C	4X/12	14.5	14.4	12.0	250

\* To properly size the drive for motor nameplate horsepower and amps, refer to Chapter 3 for more information.

\*\* Full load at all carrier frequencies. Refer to Chapter 3 for more information.

## Enclosure Ratings

Each 1302 Drive has one of the following ratings:

**Table 2.B - 1302 NEMA Ratings**

<b>NEMA Rating</b>	<b>Description</b>
1	Vented. For general-purpose indoor applications.
4X/12	Not vented. Supplied with base and keypad gaskets. For use in indoor environments that require a water-tight and dust-tight enclosure. An enclosure with this NEMA rating encompasses both ratings (4X and 12).
12	Intended for use in indoor environments that require a dust-tight and drip-tight enclosure.

For clarity in this manual, 1302 Drive enclosures are identified by size as enclosures B or C. Refer to Chapter 3 for the dimensions of enclosures B through C.

## Component Locations

Figures 2.4 and 2.5 show the main components of the 1302 Drives (enclosures B and C). Appendix F lists replacement parts.

## Option Kits

The option kit which is available for the 1302 Drive is detailed in Table 2.C.

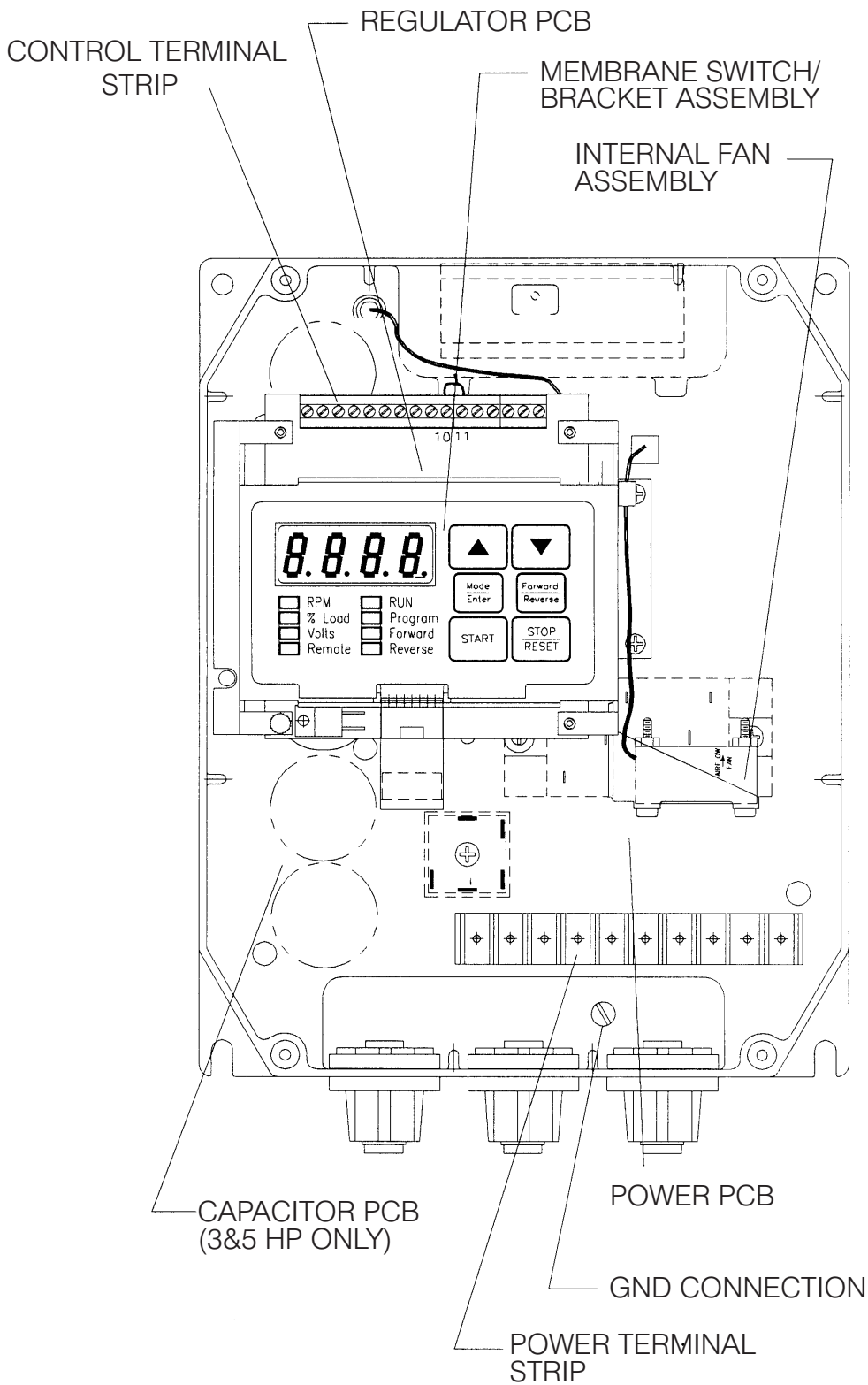
**Table 2.C - 1302 Option Kits**

<b>Option Kit Description</b>	<b>Option Kit Model Number</b>	<b>Instruction Manual</b>
Low Energy Snubber Resistor Braking Kit for 1302 Drives*	1302-2DB5010	1302-5.1

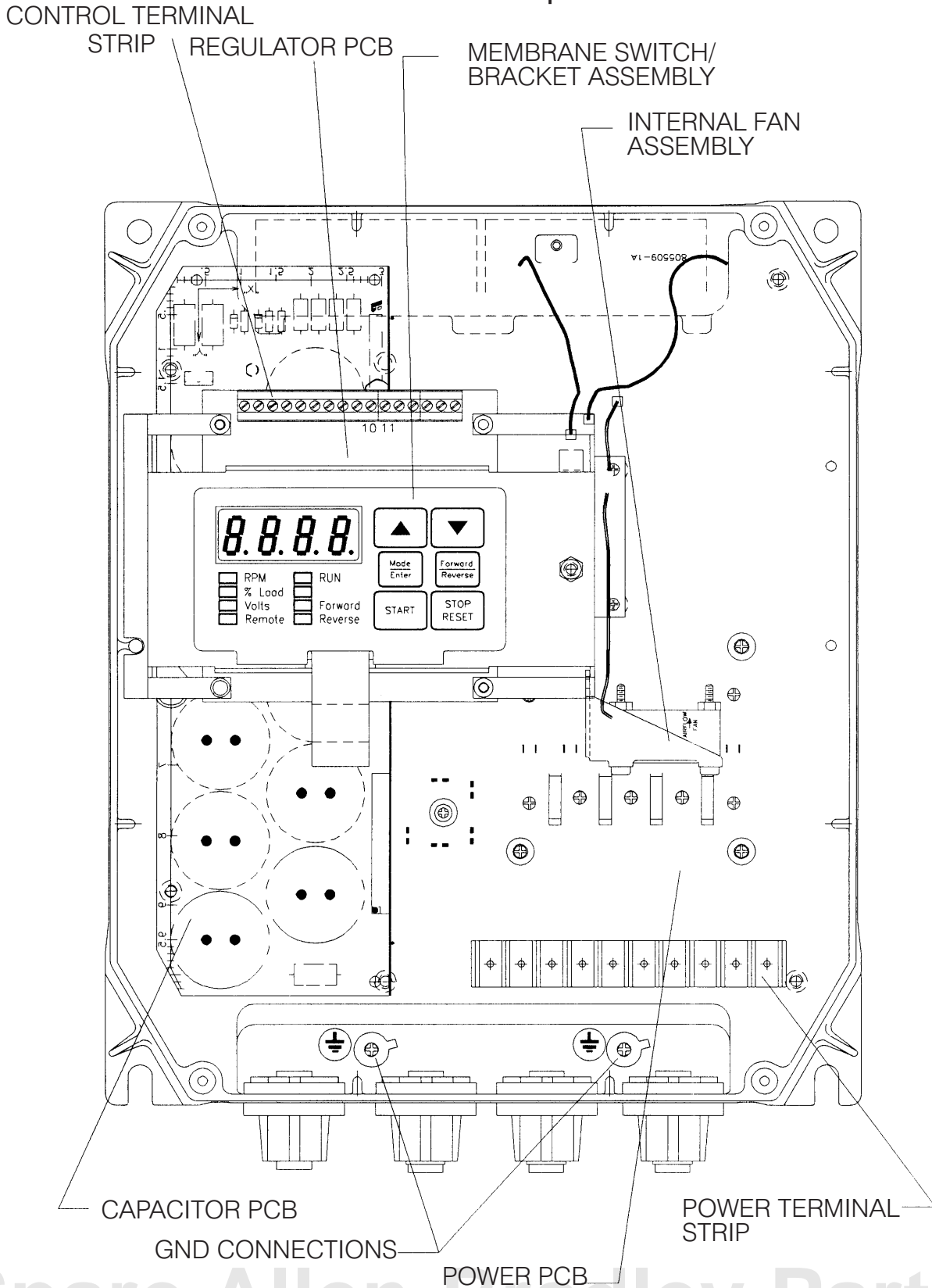
\*\* Snubber resistor braking kits require connection to the snubber resistor braking 10V power supply. See Chapter 5 (Snubber resistor wiring) for more information.

# Spare Allen-Bradley Parts

**Figure 2.4**  
**Enclosure B Component Locations**



**Figure 2.5**  
**Enclosure C Component Locations**



Spare Allen-Bradley Parts

**This Page Intentionally Blank**



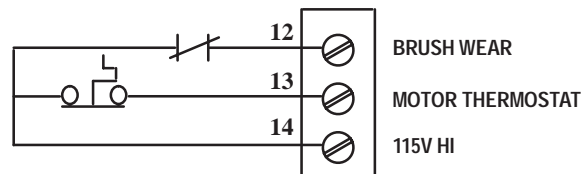
**Spare Allen-Bradley Parts**

**Table 2.A**  
**1302 Model Number Notation**

Model Number	Input Voltage	Horsepower
1.5	6.2 Nm (55 lb-in)	—
2	6.2 Nm (55 lb-in)	—
3	6.2 Nm (55 lb-in)	6.2 Nm (55 lb-in)
5	6.2 Nm (55 lb-in)	6.2 Nm (55 lb-in)
7.5	6.2 Nm (55 lb-in)	6.2 Nm (55 lb-in)
10	6.2 Nm (55 lb-in)	6.2 Nm (55 lb-in)
15	13.6 Nm (120 lb-in)	6.2 Nm (55 lb-in)
20	13.6 Nm (120 lb-in)	6.2 Nm (55 lb-in)
25	13.6 Nm (120 lb-in)	6.2 Nm (55 lb-in)
30	13.6 Nm (120 lb-in)	13.6 Nm (120 lb-in)
40	22 Nm (200 lb-in)	13.6 Nm (120 lb-in)
50	22 Nm (200 lb-in)	13.6 Nm (120 lb-in)
60	22 Nm (200 lb-in)	13.6 Nm (120 lb-in)
75	22 Nm (200 lb-in)	22 Nm (200 lb-in)
100	—	22 Nm (200 lb-in)
125	—	22 Nm (200 lb-in)
150	—	22 Nm (200 lb-in)

Note:

**Figure 2.19**  
**Motor Thermostat/Brush Wear Wiring**



**115VAC Option Board CON 2**  
**115VAC Thermostat/Brush Wear Circuit**

## 1302 Preinstallation

### General

Chapter 3 provides information that you must use when planning a 1302 AC Drive installation. Installation site, wiring and motor application requirements are included in this chapter.



**ATTENTION:** The following information is merely a guide for proper installation. The National Electrical Code and any other governing regional or local code will overrule this information. The Allen–Bradley Company cannot assume responsibility for the compliance or noncompliance to any code, national, local or otherwise for the proper installation of this Drive or associated equipment. A hazard of personal injury and/or equipment damage exists if codes are ignored during installation.

---



**ATTENTION:** Hazard of electric shock or equipment damage exist if the Drive is not installed correctly. The National Electrical Code (NEC) and local codes outline provisions for safely installing electrical equipment. Installation must comply with specifications regarding wire types, conductor sizes, branch circuit protection and disconnect devices. Only qualified electrical personnel familiar with the construction and operation of the 1302 Drive and the hazards involved should install, adjust, operate, or service this equipment. Read and understand this manual and other applicable manuals in their entirety before proceeding. Failure to do so may result in personal injury and/or equipment damage.

---

## Site Requirements

It is important to properly plan before installing a 1302 Drive to ensure that the Drive's environment and operating conditions are satisfactory. Note that no devices are to be mounted behind the Drive. This area must be kept clear of all control and power wiring. Read the following recommendations before continuing with the Drive installation.

Before deciding on an installation site, consider the following guidelines:

- The area chosen should allow the space required for proper airflow as specified in the next section.
- Do not install the Drive above 1000 meters (3300 feet) without derating output power. For every 91.4 meters (300 feet) above 1000 meters (3300 feet), derate the output current by 1%.
- Verify that the Drive location will meet the following environmental conditions:
  - Operating temperature (ambient): 0 to +40°C (32 to 104°F)
  - Storage temperature (ambient): - 40 to +65°C (-40 to +149°F)
  - Humidity: 5 to 95% (non-condensing)
- Verify that NEMA 1 Drives can be kept clean, cool, and dry.
- Be sure NEMA 1 Drives are located away from oil, coolants, or other airborne contaminants.
- Verify that the AC power distribution system meets the service conditions specified in table

### Determining Total Area Requirements

Figures 3.1 and 3.2 provide drive dimensions for enclosures B and C as an aid in calculating the total area required by the 1302 Drives. Appendix A lists drive weights.

Figure 3.1  
Enclosure B Dimensions

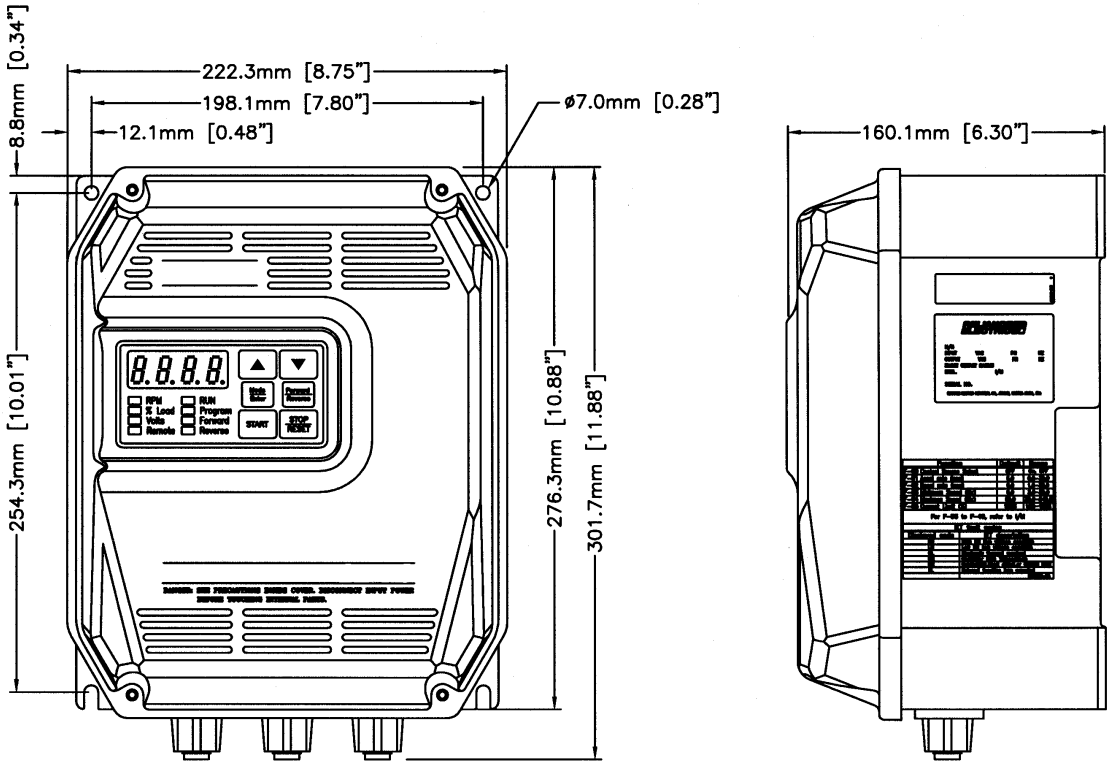
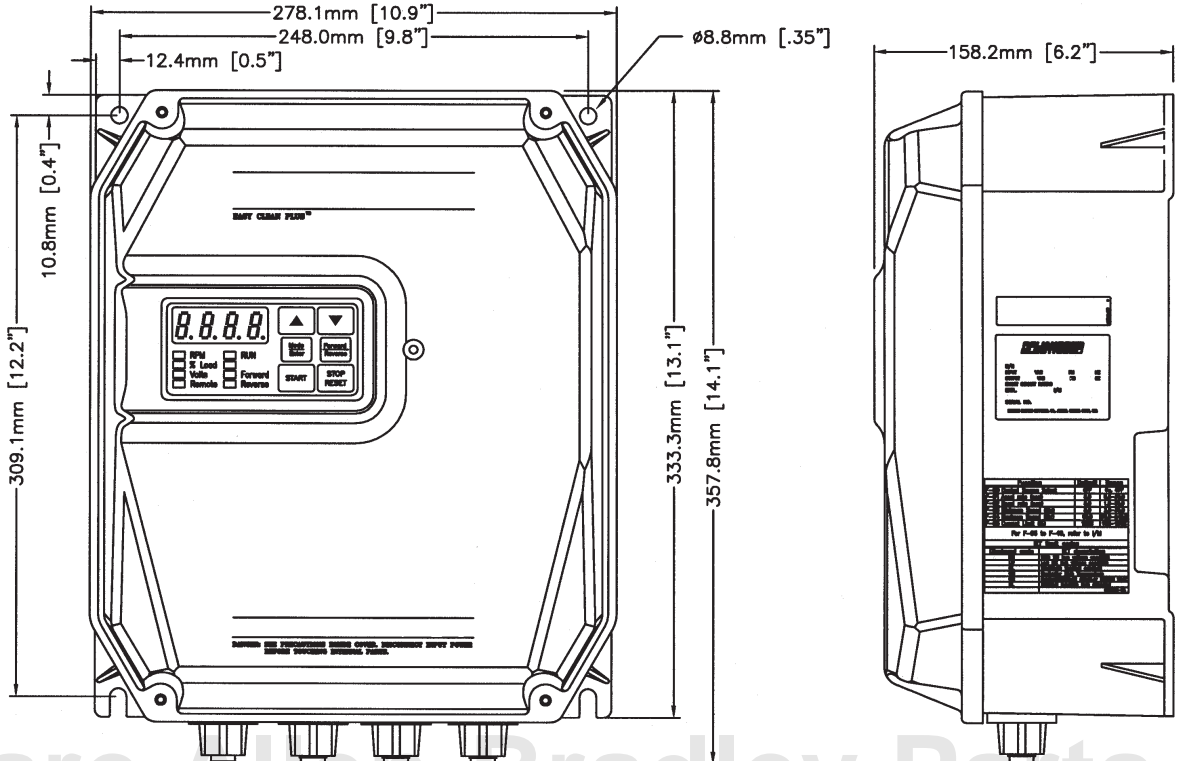


Figure 3.2  
Enclosure C Dimensions



Spare Allen-Bradley Parts

## Cooling Airflow

Be sure there is adequate clearance for air ventilation around the Drive. For best air movement, do not mount 1302 Drives directly above each other. Note that no devices are to be mounted behind the Drive. This area must be kept clear of all control and power wiring. See Table 3.A for a listing of the recommended air flow clearances.

**Table 3.A - Air Flow Clearances**

	Enclosure	
	B	C
Minimum distance from the sides of the drive if adjacent to non-heat producing equipment	102 mm (4")	102 mm (4")
Minimum distance from the top and bottom of the drive if adjacent to non-heat producing equipment	102 mm (4")	102 mm (4")
Minimum distance from the sides of the drive if adjacent to other drives	102 mm (4")	102 mm (4")
Minimum distance from the top and bottom of the drive if adjacent to other drives	254 mm (10")	254 mm (10")

### Verifying the Drive's Power Loss Ratings

When installing a 1302 Drive inside of another enclosure, you should consider the Drive's watts loss rating shown in Table 2.A. This table lists the typical full load power loss watts value under all operating carrier frequencies. Ensure adequate ventilation is provided based on the Drive's watts loss rating.

## Wiring Requirements

Evaluate the following areas of Drive wiring before you start the installation: size of available conduit, size of power and control wiring, and motor lead lengths.

### Verifying Conduit Sizes

It is important to determine the size of the conduit openings accurately so that the wire planned for a specific entry point will fit through the opening. Figures 4.1 and 4.2 detail conduit opening sizes.

### Recommended Power Wire Sizes

Size input power wiring according to applicable codes to handle the Drive's continuous-rated input current. Size output wiring according to applicable codes to handle the Drive's continuous-rated output current. Table 3.B provides recommended power wiring sizes. Use only copper wire with a minimum temperature rating of 60/75°C. Table 3.C contains the recommended tightening torque values for all power wiring terminals.

Table 3.B - Recommended Power Wire Sizes

Type of Wiring	Terminals	Size of Wire (maximum)*
AC Input Power	R(L1), S(L2), T(L3)	14 AWG, 2 (mm <sup>2</sup> )
Output Power	U(T1), V(T2), W(T3)	14 AWG, 2 (mm <sup>2</sup> )
DC Bus	-, +	14 AWG, 2 (mm <sup>2</sup> )
Snubber Resistor	+10 VDC, 10 COM	14 AWG, 2 (mm <sup>2</sup> )
Ground	GND	14 AWG, 2 (mm <sup>2</sup> )

Table 3.C - Recommended Power Terminal Tightening Torque

Drives	Terminals	Maximum Tightening Torque
All	All power wires	1.08 Newton-meters (9.5 in-lb)

### Recommended Control and Signal Wire Sizes

Table 3.D shows the recommended wire sizes to connect I/O signals to the terminal strip on the Regulator board. The minimum wire insulation rating is 600V. Operator controls can be up to 303 meters (1000 feet) from the 1302 Drive. All signal wires should be twisted-pair.

Table 3.D - Recommended Control and Signal Wire Sizes and Tightening Torque

Drives	Terminals	Minimum Wire Size	Maximum Wire Size	Maximum Tightening Torque
All	1-16	20 AWG, 0.5 (mm <sup>2</sup> )	14 AWG, 2 (mm <sup>2</sup> )	0.5 Newton-meters (4.5 in-lb)

# Spare Allen-Bradley Parts

### Recommended Motor Lead Lengths

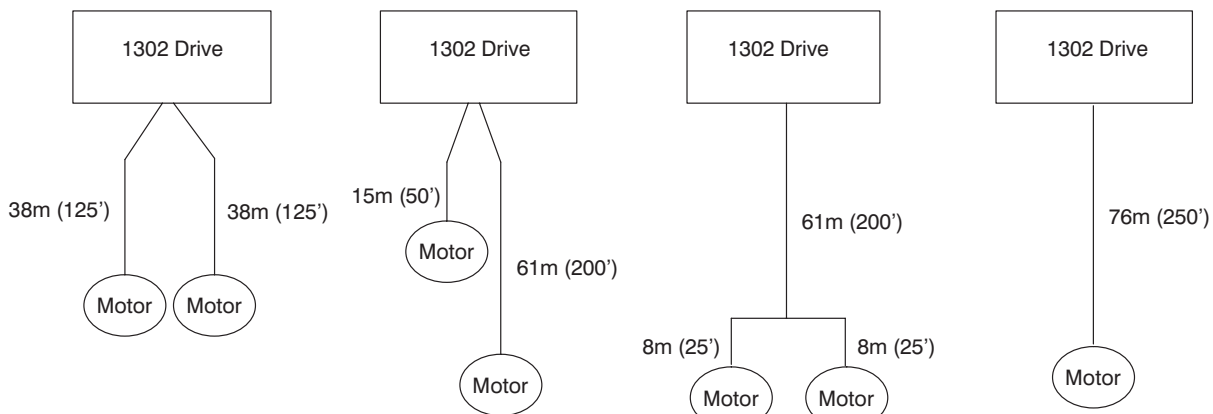
The following motor lead lengths are recommended to reduce line disturbances and noise. See Figure 3.3.

- For applications using one motor, motor lead length should not exceed 76 meters (250 feet).
- For applications with multiple motors, total motor lead length should not exceed 76 meters (250 feet).

When total lead length exceeds 76 meters (250 feet), nuisance trips can occur, caused by capacitive current flow to ground. Note that these capacitively-coupled currents should be taken into consideration when working in areas where drives are running. If the motor lead length must exceed these limits, the addition of output line reactors or other steps must be taken to correct the problem. See Table 3.E. Note that the motor lead lengths shown in Table 3.E are only guidelines. Your application may be restricted to a shorter motor lead length due to:

- The type of wire
- The placement of the wire (for example, in conduit or a cable tray)
- The type of line reactor (For example, with or without LC filters)
- The type of motor

**Figure 3.3**  
How to Measure Motor Lead Lengths



All examples represent 76m (250') of motor lead length.



**Table 3.E**  
**Maximum Motor Cable Length Restrictions in meters (Feet) for 1302**

Drive kW (HP)	Motor kW (HP)	No External Devices			w/ 1204-TFA1 Terminator			w/ Reactor/Filter at Drive		
		Motor			Motor			Motor		
		A	B	1329R	A	B	1329R	A	B	1329R
		Any Cable	Any Cable	Any Cable	Any Cable	Any Cable	Any Cable	Any Cable	Any Cable	Any Cable
0.75 (1)	0.75 (1)	NR	NR	45.7 (150)	NR	121.9 (400)	152.4 (500)	152.4 (500)	152.4 (500)	152.4 (500)
1.5 (2)	1.5 (2)	NR	NR	45.7 (150)	NR	121.9 (400)	152.4 (500)	152.4 (500)	152.4 (500)	152.4 (500)
2.2 (3)	2.2 (3)	NR	NR	45.7 (150)	NR	152.4 (500)	304.8 (1000)	152.4 (500)	152.4 (500)	304.8 (1000)
3.7 (5)	3.7 (5)	NR	NR	45.7 (150)	NR	152.4 (500)	304.8 (1000)	152.4 (500)	152.4 (500)	304.8 (1000)
5.6 (7.5)	5.6 (7.5)	NR	NR	76.2 (250)	NR	NR	NR	152.4 (500)	152.4 (500)	304.8 (1000)
7.5 (10)	7.5 (10)	NR	NR	76.2 (250)	NR	NR	NR	152.4 (500)	152.4 (500)	304.8 (1000)

**Type A Motor Characteristics:** No phase paper or misplaced phase paper, lower quality insulation systems, corona inception voltages between 850 and 1000 volts

**Type B Motor Characteristics:** Properly placed phase paper, medium quality insulation systems, corona inception voltages between 1000 and 1200 volts.

**1329R Motors**  
 These AC Variable Speed motors are "Power Matched" for use with Allen-Bradley Drives. Each motor is energy efficient and designed to meet or exceed the requirements of the Federal Energy Act of 1992. All 1329R motors are optimized for variable speed operation and include premium inverter grade insulation systems which meet or exceed NEMA MG1, Part 31.40.4.2  
**1329R motors at 575V are rated 1850V insulation value.**

**Recommended MTE Reactor and LC Filter:**

1 hp at 4kHz use MTE part number:	RL- 00803C
1 hp at 6/8kHz use MTE part number	RL- 00202C
2/3/5 hp use MTE part number	RL- 00803C
7.5 hp use MTE part number	RL- 01803C
10 hp use MTE part number	RL- 01803C

## Input Fusing



**ATTENTION:** The 1302 AC Drive does not provide input power short circuit fusing. Specifications for the recommended fuse size and type to provide Drive input power protection against short circuits are provided in Table 3.F. Branch circuit breakers or disconnect switches cannot provide this level of protection for Drive components.

Input line branch circuit protection fuses must be used to protect the input power lines. See Figure 5.A. Table 3.F shows recommended fuse values. These fuse ratings are applicable for one Drive per branch circuit. No other load may be applied to that fused circuit. Note that contactors and circuit breakers are not recommended for AC input line branch protection.

Spare Allen-Bradley Parts

Table 3.F- AC Input Line Fuse Selection Values

Model Number	Fuse Rating*
1302-C001-AA	4A
1302-C001-AF	4A
1302-C002-AA	7A
1302-C002-AF	7A
1302-C003-AA	10A
1302-C003-AF	10A
1302-C004-AA	15A
1302-C005-AA	15A
1302-C005-AF	20A
1302-C007-AF	20A
1302-C010-AA	25A
1302-C010-AF	25A

\* Recommended fuse type: UL Class J, 600V, time-delay, or equivalent.

## Emergency Stop Installation



**ATTENTION:** The 1302 Drive control circuitry includes solid state components. If hazards due to accidental contact with moving machinery or unintentional flow of liquid, gas or solids exist, an additional hardwired stop circuit is required to remove AC line power to the Drive. When AC input power is removed, there will be a loss of inherent regenerative braking effect and the motor will coast to a stop. An auxiliary braking method may be required.

Depending upon the requirements of the application, the 1302 Drive can be programmed to provide either a coast-to-rest (default) or a ramp-to-rest (user-option) operational stop without physical separation of the power source from the motor. Refer to Chapters 5 and 8 (parameter F-16) for more information on how to program an operational stop.

In addition to the operational stop, users must provide a hardwired emergency stop external to the Drive. The emergency stop circuit must contain only hardwired electromechanical components. Operation of the emergency stop must not depend on electronic logic (hardware or software) or on the communication of commands over an electronic network or link.

### Complying with Machinery Safety Standard EN 6024-1:1992

This section applies to users who must comply with machinery safety standard EN 60204-1:1992, part 9.2.5.4, Emergency Stop.

The 1302 Drive coast-to-rest stop is a category 0 operational stop. The ramp-to-rest stop is a category 1 operational stop.

The required external hardwired emergency stop must be either a category 0 or 1 stop, depending on the user's risk assessment of the associated machinery. In order to fully comply with machinery safety standard EN 60204-1:1992, part 9.2.5.4, at least one of the two stop methods must be a category 0 stop.

## Motor Considerations

To obtain motor nameplate horsepower, the Drive's output current rating at the selected carrier frequency should be equal to or greater than motor nameplate current. If the motor nameplate current rating is higher than the Drive's output current rating, derate motor horsepower by the ratio of the Drive's output ampere rating (at the selected carrier frequency) to the motor nameplate current. Note that this approximation is only accurate if the Drive and the motor have nearly the same rating.

### Single Motor Applications

Size the drive and motor for the load and speed requirements of the specific application.

The motor's operating current must not exceed the drive's rated output current (at the selected carrier frequency). In addition, the motor's horsepower rating (for example, 1, 2, 3, 5, 7, 10 HP) must not be more than one horsepower range larger than the Drive's horsepower rating.

If the motor will be operated below one-half of its rated speed, the motor overload relay may not protect the motor because of reduced cooling action due to the reduced speed. A motor thermostat, internal to the motor, should be installed to monitor the actual temperature of the windings.

### Multiple – Motor Applications

One Drive can run two or more motors. Adhere to the following requirements to assure correct Drive operation in this case:

- When starting and stopping all the motors at the same time (using the Drive for starting and stopping), the sum of the full-load sine wave currents of all the motors must be equal to or less than the maximum sine wave output current at the selected carrier frequency for the Drive.

For example:  $I_{FLA} \text{ (Motor 1)} + I_{FLA} \text{ (Motor 2)} + I_{FLA} \text{ (Motor 3)} = I_{TLA} \text{ (Total Load)}$

Where:  $I_{TLA} \leq 100\%$  rated drive output at the selected carrier frequency

- When one or more of the motors connected to the output of the Drive are to start independently (using a secondary switching device to add or remove the motor from the circuit):

Any motor that starts or stops while the Drive is running must have a current rating less than 10% of the maximum sine wave current rating of the Drive at the selected carrier frequency.

# Spare Allen-Bradley Parts

The sum of the maximum full-load sine wave currents of all the motors connected continuously to the Drive must be less than the maximum output current rating under all conditions.

Note that each motor requires separate thermal overload protection (for example, a motor relay or a motor thermostat).

## Installation

### Introduction

This chapter shows how to mount the 1302 Drive and its external components. Also shown are the entry areas for routing wiring in and out of the Drive.

### Mounting the Drive

Attach the drive to the selected flat, vertical surface using the mounting holes provided. Enclosure B and C Drives have four mounting holes. In order to maintain a flat mounting surface and to ensure that bolt tightness is maintained, use washers under the bolt heads. Refer to Figures 3.1 and 3.2 for Drive mounting dimensions. Use the following user-supplied mounting bolts and washers:

- Enclosure B Drives: four M8 (5/16")
- Enclosure C Drives: four M8 (5/16")

### Routing Wires

All wiring should be installed in conformance with the applicable local, national, and international codes (e.g., NEC/CEC). Signal wiring, control wiring, and power wiring must be routed in separate conduits to prevent interference with Drive operation. Do not route wires behind the Drive. Use grommets when hubs are not provided to guard against wire chafing. Figures 4.1 and 4.2 show the wire routing, grounding terminal, and power terminal strips of the 1302 Drives.



**ATTENTION:** Do Not route signal and control wiring in the same conduit with power wiring. This can cause interference with Drive operation. Failure to observe this precaution could result in damage to, or destruction of, the equipment.

---

Do not route more than three sets of motor leads through a single conduit. This will minimize cross-talk that could reduce the effectiveness of noise reduction methods. If more than three Drive/motor connections per conduit are required, you must use shielded cable. If possible, each conduit should contain only one set of motor leads.



**ATTENTION:** Unused wires in conduit must be grounded at both ends to avoid a possible shock hazard caused by induced voltages. Also, if a Drive sharing a conduit is being serviced or installed, all Drives using this conduit should be disabled to eliminate the possible shock hazard from cross-coupled motor leads. Failure to observe these precautions could result in bodily injury.

**Figure 4.1  
Enclosure B Wire Routing Locations**

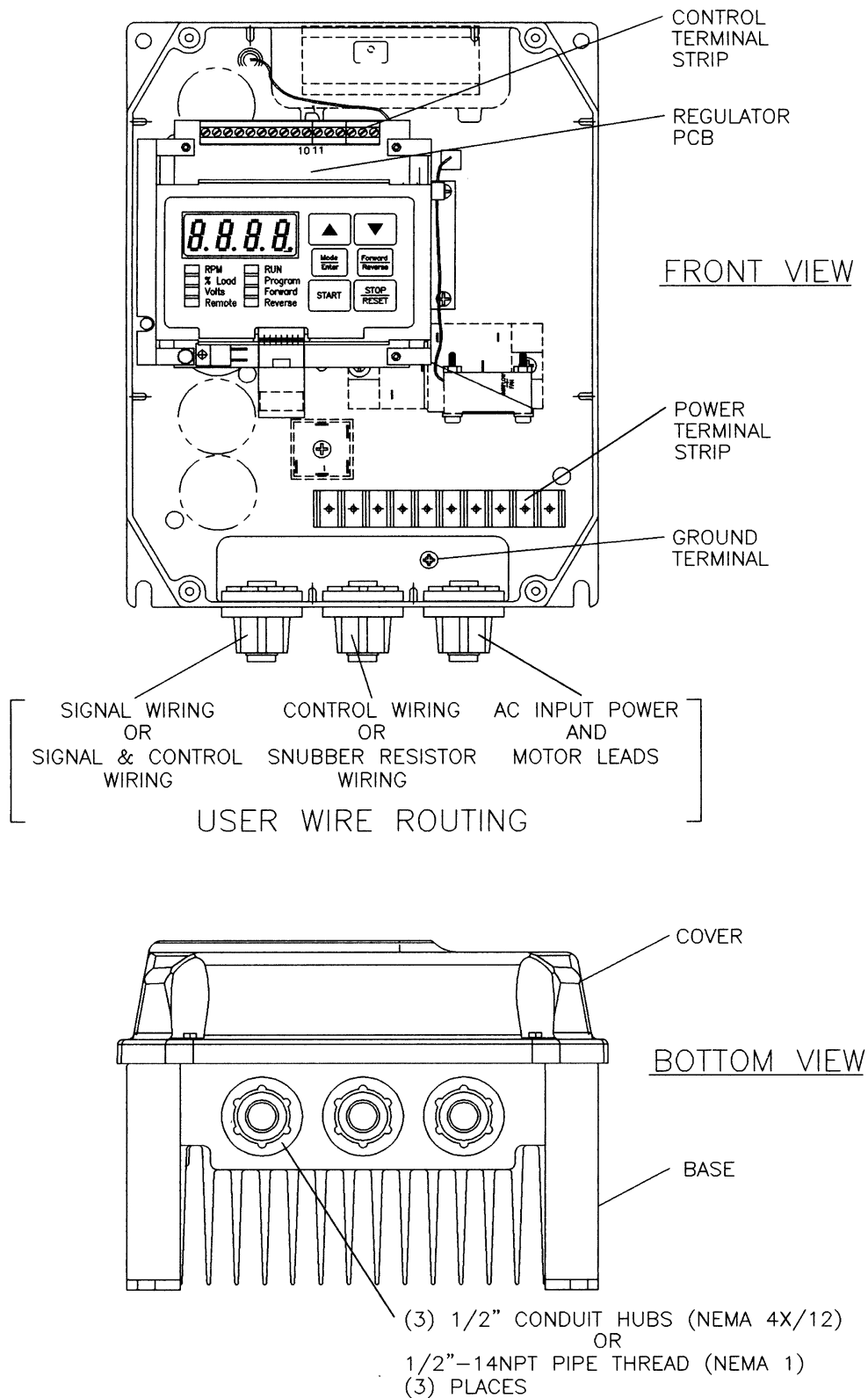
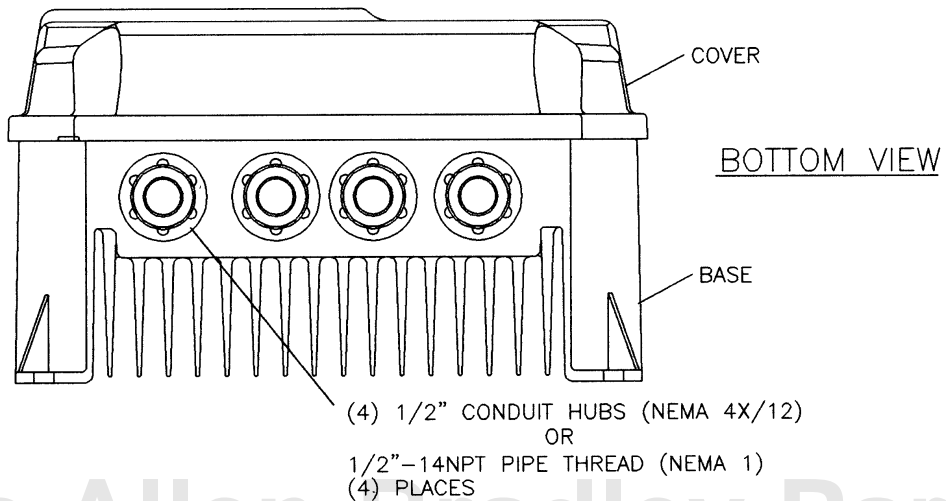
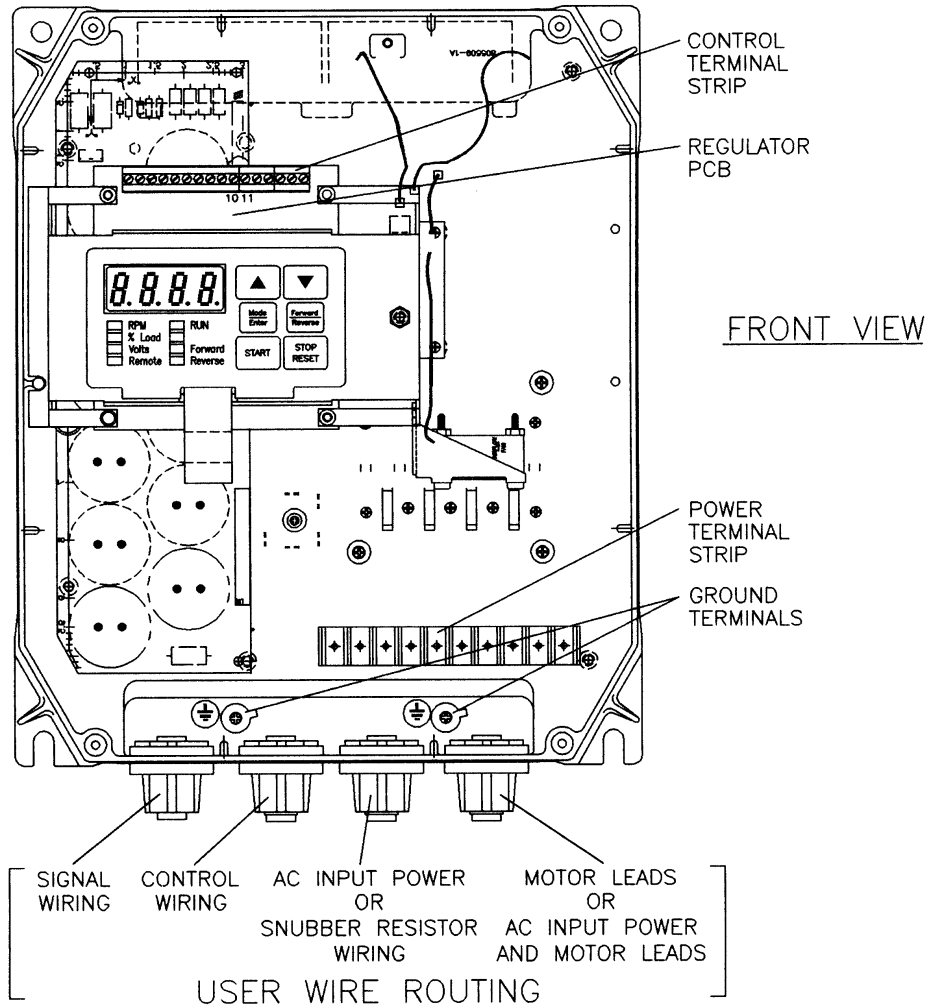


Figure 4.2  
Enclosure C Wire Routing Locations



Spare Allen-Bradley Parts

## External Component Installation

Install the input power and output power components that are located outside of the 1302 enclosure. See Figure 5.1. The following sections describe disconnect, transformer, and AC line branch protection installation.

### Disconnects

An input disconnect (for example, a switch or circuit breaker) must be installed in the line before the Drive input terminals in accordance with local, national, and international codes (e.g., NEC/CEC). Size the disconnect according to the inrush current as well as any additional loads the disconnect might supply. Coordinate the trip rating for the current (10 to 12 times the full load current) with that of the input isolation transformer, if used. Refer to the Transformers section of this chapter for additional information.

### Input AC Line Branch Protection

---



**ATTENTION:** Most codes require that upstream branch protection be provided to protect input power wiring. To guard against personal injury and/or equipment damage caused by improper fusing, use only properly rated line fuses. Branch circuit breakers or disconnect switches cannot provide this level of protection for Drive components.

---

User-supplied branch circuit protection fuses must be installed according to the applicable local, national, and international codes (for example, NEC/CEC). The fuses must be installed in the line before the Drive's AC input terminals. Table 3.F provides fuse values.

### Transformers

---



**ATTENTION:** If the AC input power system does not have a neutral or one phase referenced to ground, an isolation transformer with the neutral of the secondary grounded is **highly recommended**. If the line-to-line voltages on any phase can exceed 125% of the nominal line-to-line voltage, an isolation transformer with the neutral of the secondary grounded, is **always required**. Failure to observe these precautions could result in bodily injury or damage to equipment.

**ATTENTION:** When the AC line is shared directly with other SCR-rectified drives, an optional snubber resistor braking kit might be required to alleviate excess DC bus voltage. Failure to observe these precautions could result in damage to, or destruction of, the equipment.

---



Input isolation transformers may be needed to help eliminate the following:

- Damaging line voltage transients.
- Line noise from the Drive back to the incoming power source.
- Damaging currents that could develop if a point inside the Drive becomes grounded.

Observe the following guidelines when installing an isolation transformer:

- A power disconnecting device must be installed between the power line and the primary of the transformer. If the power disconnecting device is a circuit breaker, the circuit breaker trip rating must be coordinated with the inrush current (10 to 12 times the full load current) of the transformer.
- Do NOT use an input isolation transformer rated more than 100 KVA for 230 VAC (or 1000 KVA for 460 VAC) with less than 5% impedance directly ahead of the Drive without additional impedance between the Drive and the transformer.

If your 1302 application requires the use of an output transformer, contact Allen–Bradley for assistance.

### Output Contactors



**ATTENTION:** Any disconnecting means wired to drive output terminals U, V, and W must be capable of disabling the Drive if opened during Drive operation. If opened during Drive operation, the Drive will continue to produce output voltage between U, V, and W. An auxiliary contact must be used to simultaneously disable the Drive or output component damage may occur.

Output contactors provide a positive means of disconnecting the motor from the Drive. If your 1302 application requires the use of output contactors, contact Allen–Bradley for assistance.

### Mechanical Motor Overload Protection

To provide the motor with overload protection, local, national, and international codes (for example, NEC/CEC) require that a motor thermostat, internal to the motor, be installed or an electronic thermal motor overload relay, sized to protect the motor, be installed between the motor and the Drive's output terminals.

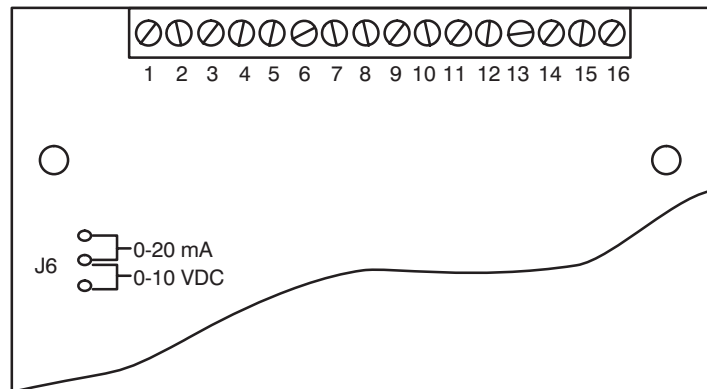
The Electronic Thermal Overload parameter (F-14) may be used in place of the electronic thermal motor overload relays in single motor applications. Note, however, that temperature-sensing devices integral to the motor are the best way of thermally-protecting AC motors under all conditions. Parameter F-14 must be enabled to provide overload protection. Refer to Chapter 8 for the parameter description.

## Setting the Analog Input Jumper on the Regulator Board

In multiple motor applications, each motor must have its own user-supplied overload protection.

1302 Drives have an analog speed reference input. This is a jumper-selectable 0 to 10 VDC or 0 to 20 mA input with programmable gain and offset adjustments (parameters F-11 and F-12). Jumper J6 on the Regulator board is set to match the type of incoming analog signal, either voltage or current. See Figures 2.2, 4.3, and 5.3. Refer to Chapter 5 for more information.

**Figure 4.3**  
**Jumper J6 Settings for the Analog Input Speed Reference**



**ATTENTION:** Disconnect and lock out power to the Drive before setting Jumper J6. Failure to disconnect power may result in death or serious injury. Verify bus voltage using the following procedure before touching any components in the drive. Do not attempt to service the Drive until the bus voltage has discharged to zero volts.

Use the following procedure to set jumper J6:

- Step 1. Turn off and lock out input power. Wait five minutes
- Step 2. Remove the cover from the Drive by unscrewing the four cover screws.
- Step 3. Verify that the DC bus voltage is zero by following the procedure in Chapter 9 titled *Verifying DC Bus Voltage*.
- Step 4. Locate jumper J6 on the Regulator board. Refer to Fig. 2.3
- Step 5. Move the jumper to the desired setting as detailed in Fig. 4.3
- Step 6. Re-attach the cover
- Step 7. Re-apply input power
- Step 8. Verify that parameters F-11 and F-12 are correctly set.

Note that if the setting of jumper J6 is changed, the regulator software will not automatically detect it. Verify that parameters F-11 (gain) and F-12 (offset) are set correctly before starting the Drive.

## Motor Preparation

Follow these guidelines when preparing to install the motor:

- Verify that the motor is the appropriate size to use with the Drive.
- Verify that the total motor lead length does not exceed the values given in Chapter 3.
- Follow the instructions in the motor instruction manual when installing the motor.
- Verify that the motor is properly aligned with the application's machine to minimize unnecessary motor loading due to shaft misalignment.
- If the motor is accessible when it is running, install a protective guard around all exposed rotating parts.

# Spare Allen-Bradley Parts

**This Page Intentionally Blank**

## Drive Wiring

### Introduction

This chapter describes how to wire the 1302 Drive including: input wiring, control and signal wiring, output wiring, and grounding.

#### Input Power Wiring

Use the following steps to connect AC input power to the Drive:

- Step 1. Verify that the AC input power to the Drive corresponds to the drive's nameplate voltage and frequency.
- Step 2. Wire the AC input power leads by routing them according to the type of enclosure. See Figures 4.1 and 4.2 and Table 3.B for recommended wire sizes.

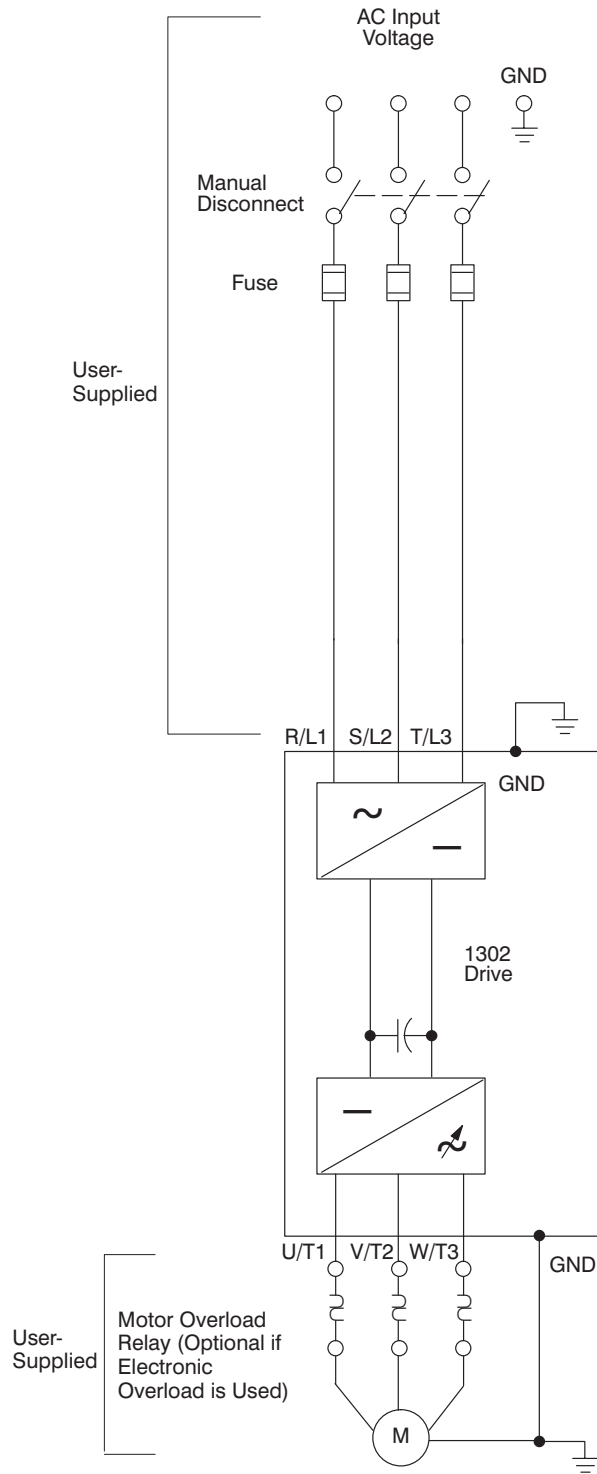


**ATTENTION:** Do Not route signal and control wiring with power wiring in the same conduit. This can cause interference with Drive operation. Failure to observe this precaution could result in erratic drive operation or damage to, or destruction of, the equipment.

---

- Step 3. Connect the AC input power leads to terminals R,S,T on the power terminal strip.
- Step 4. Tighten terminals R and S (single-phase input) or terminals R,S,T (three-phase input) to the proper torque as shown in Table 3.D.

**Table 5.1**  
**Typical Electrical Connections**

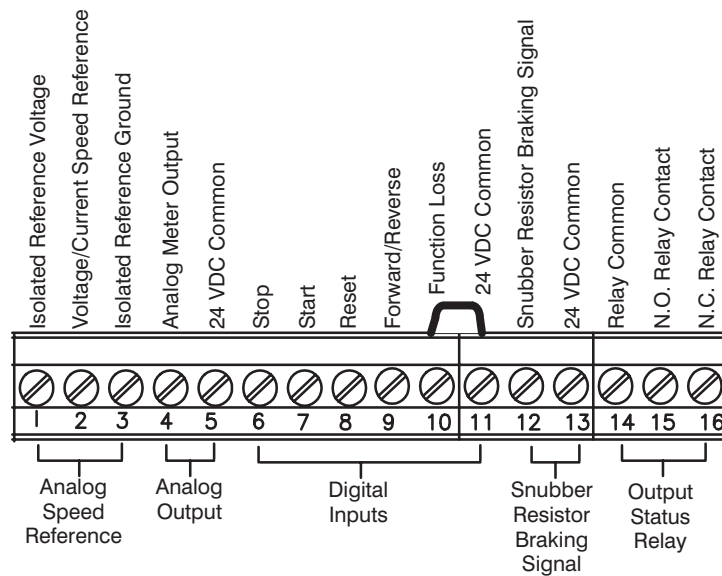


## Signal and Control Wiring

The Terminal strip on the Regulator board provides terminals for connecting signal (for example, external speed reference and analog output) and control (for example, stop, start, and function loss) wiring. See Figure 5.2. Terminals for the following wire connections are provided:

- Terminals 1–3: analog speed reference connections
- Terminals 4–5: analog output connections
- Terminals 6–11: digital input connections
- Terminals 12–13: snubber resistor connections
- Terminals 14–16: output status connections

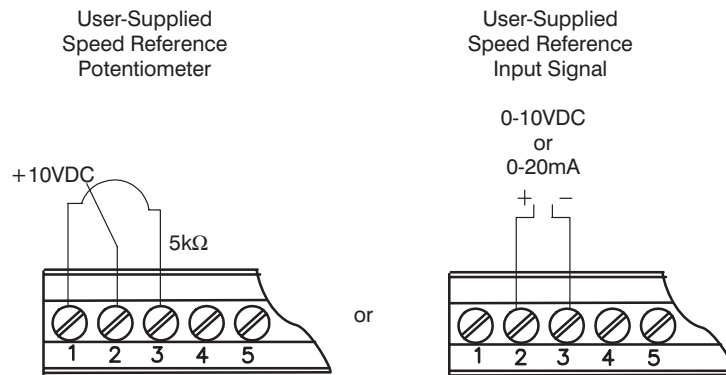
**Table 5.2**  
**Typical Control Terminal Strip Connections**



### Analog Speed Reference Wiring

Analog speed reference input wiring connects to terminals 1 through 3 on the Regulator board's terminal strip. See Figure 5.3. This reference signal is jumper-selectable for either a 0 to 10 VDC or 0 to 20 mA input. The setting of jumper J6 on the Regulator board determines whether the input reference is a voltage or current signal. This reference signal can be provided by either a user-supplied 5K ohm potentiometer or an external 0-10 VDC/0-20 mA supply. See Chapter 4 for more information.

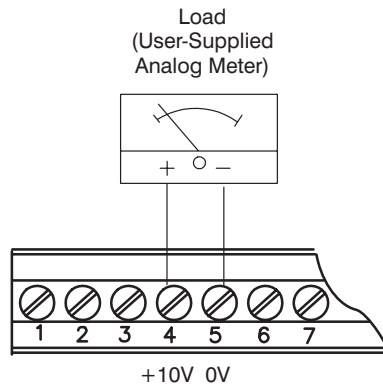
**Table 5.3**  
**Analog Speed Reference Wiring Connections**



**Analog Output Wiring**

Analog output wiring connects to terminals 4 and 5 on the Regulator board’s terminal strip. See Figure 5.4. This is a scaled 0 to 10 VDC output signal that is proportional to either current speed, percent of load, calculated output voltage, or percent of the selected reference value, whichever is selected through parameter F-29. This output signal is available during both local and remote operation.

**Figure 5.4**  
**Analog Output Wiring Connections**



**Digital Input Wiring**

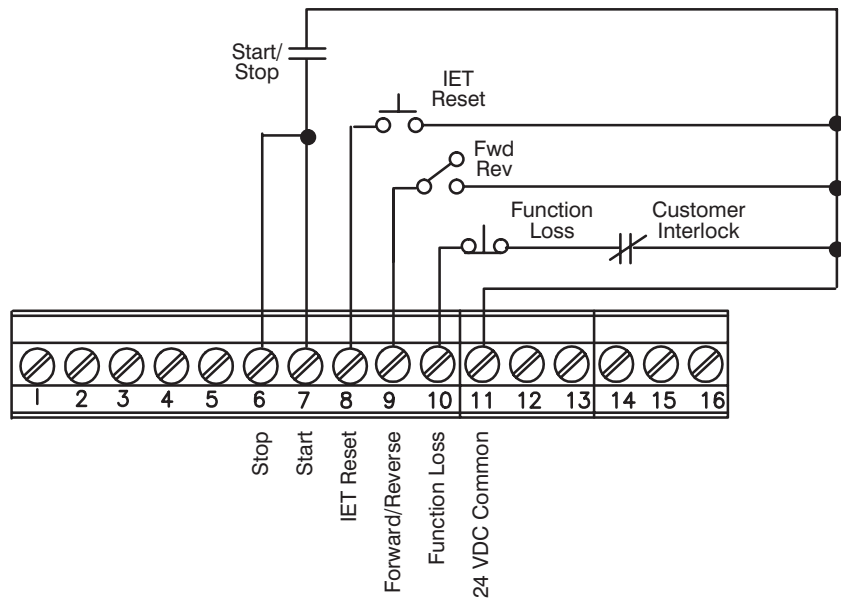
Digital input wiring connects to terminals 6 through 11 on the Regulator board’s terminal strip. The Drive has a 24 VDC power supply that provides the required voltage for control signals. Enabling or disabling a control signal requires that a contact (switch) be opened or closed.



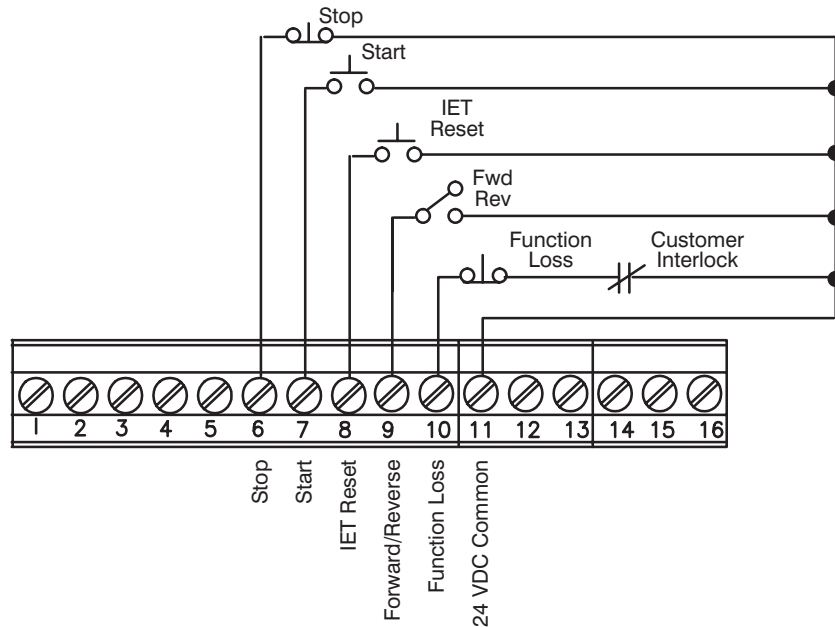
### Start and Stop Control Wiring

Start and stop control wiring connects to terminals 6, 7, and 11. See Figures 5.5 and 5.6. Note that these start/stop wiring connections are not to be used in multi-speed preset applications which are discussed in the following section.

**Figure 5.5**  
Two-Wire Start/Stop Sample Control Wiring



**Figure 5.6**  
Three-Wire Start/Stop Sample Control Wiring



Spare Allen-Bradley Parts

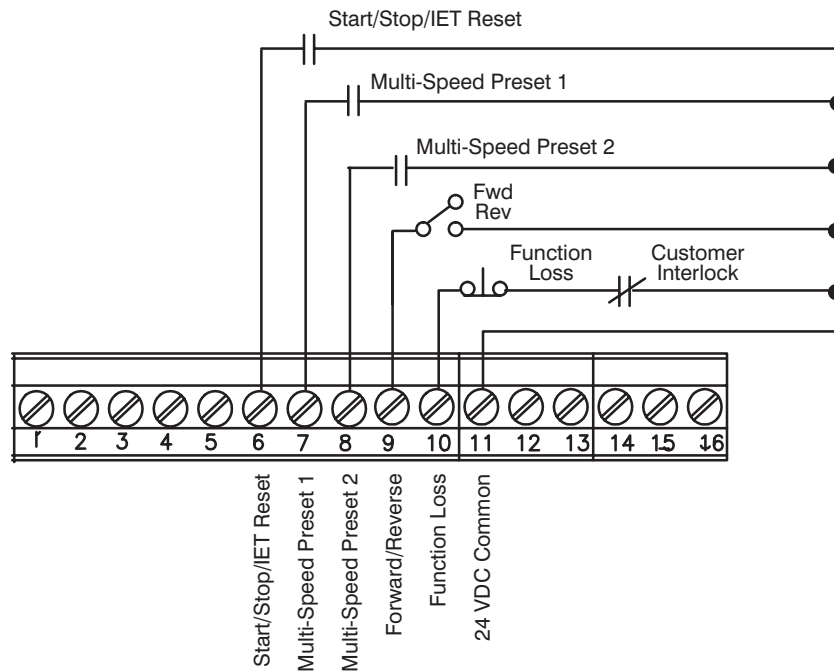
### Multi-Speed Preset Wiring

Multi-speed preset wiring connects to terminals 6 through 8, and 11. See Figure 5.7. When control type 3 is selected through parameter F-00, remote terminal strip control is enabled with multi-speed presets. This mode of operation changes the functionality of terminals 6 through 8 and may be used in place of 2- and 3-wire start/stop wiring. See Figure 5.8.

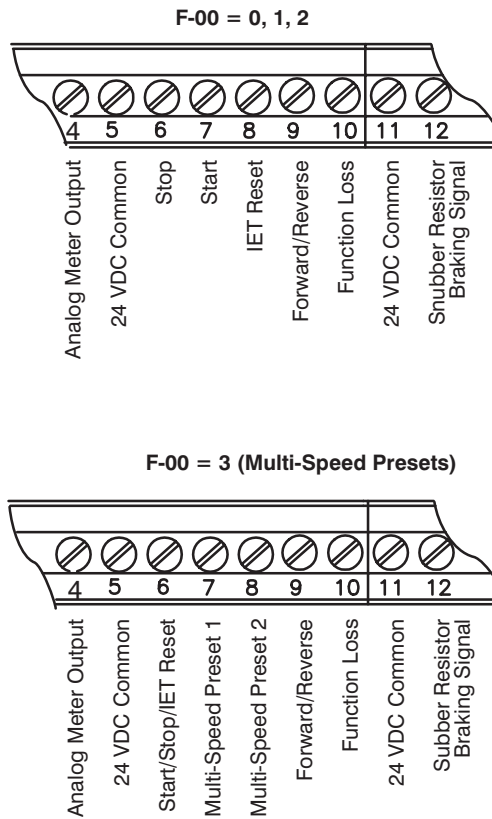
When you enable multi-speed preset operation, the state of terminals 7 and 8 determine the source of the speed reference:

Terminal 7	Terminal 8	Speed Reference Source
0	0	Terminal Strip Analog Input
0	1	Multi-Speed Preset 1 (Parameter F-23)
1	0	Multi-Speed Preset 2 (Parameter F-24)
1	1	Multi-Speed Preset 3 (Parameter F-25)

Figure 5.7  
Multi-Speed Preset Sample Control Wiring



**Figure 5.8**  
Terminal Usage During Multi-Speed Preset Operation



### IET Reset Control Wiring

IET reset control wiring connects to terminals 8 and 11. See Figures 5.5 and 5.6. Note that these reset wiring connections are not to be used in multi-speed preset applications. See Figures 5.7 and 5.8.

### Forward/Reverse Control Wiring

Forward/reverse control wiring connects to terminals 9 and 11. See Figures 5.5 through 5.7. Note that the setting of the forward/reverse switch is ignored when parameter F-17 is equal to 1 (disable reverse operation).

### Function Loss Control Wiring

Function loss control wiring connects to terminals 10 and 11. See Figures 5.5 through 5.7. Typically, a function loss input is a maintained, normally-closed pushbutton.

A signal must be present at terminal 10 for the Drive to run. A factory-installed jumper connects terminals 10 and 11 which provides that signal. Remove this jumper if a function loss input, a coast-stop pushbutton, or another external interlock (for example, a motor thermostat) is used. Removing the jumper allows the Drive to stop when the contact is open.



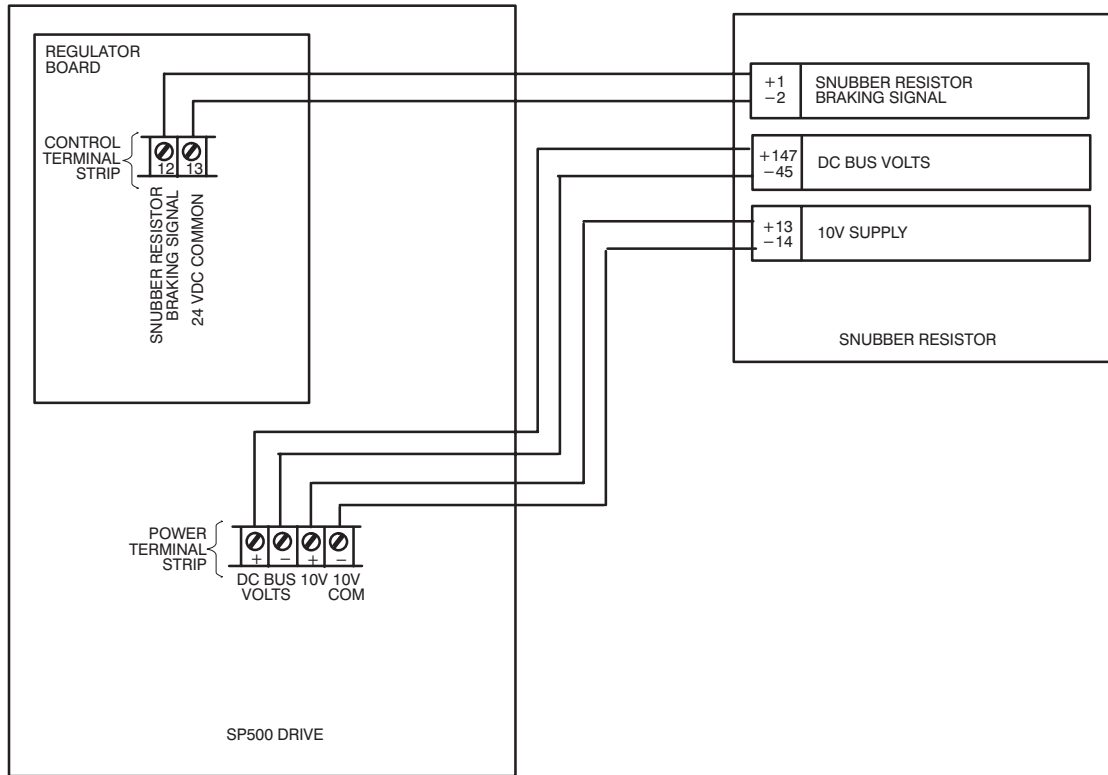
**ATTENTION:** The 1302 control circuitry includes solid state components. You must provide an additional hardwired stop circuit to remove AC line power to the Drive in the case of improper operation. Failure to provide a hardwired emergency stop could result in equipment damage, bodily injury or death. When AC input power is removed, there will be a loss of inherent regenerative braking effect and the motor will coast to a stop. An auxiliary braking method may also be required depending on the application.

### Snubber Resistor Wiring

Snubber resistor wiring connects to terminals 12 and 13 on the Regulator board's terminal strip. See Figure 5.9.

Drive Model Number	Snubber Resistor Terminals	Control Terminal Strip Connections	Power Terminal Strip Connections
1302 – CXXX	1 (+)	12	N/A
	2 (-)	13	
	147 (+)	N/A	(+) DC Bus
	45 (-)		(-) DC Bus
	13 (+)	N/A	(+) 10V
	14 (-)		(-) 10 COM

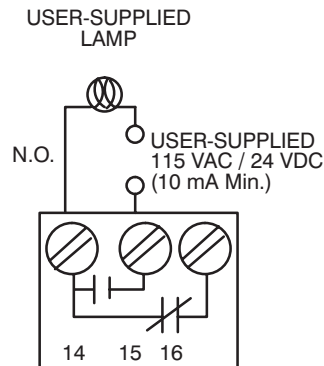
**Figure 5.9**  
**Snubber Resistor Wiring Connections for 1302 Drives**



**Output Status Relay Wiring**

Output status wiring connects to terminals 14 through 16 on the Regulator board’s terminal strip. See Figure 5.10. Parameter F-09 specifies the type of status indication provided by the output relay. See the F-09 parameter description in Chapter 8 for more information.

**Figure 5.10**  
**Output Status Relay Wiring Connections**



## Output Power Wiring

Use the following steps to connect AC output power wiring from the Drive to the motor:

- Step 1. Wire the AC output power leads by routing them according to the type of enclosure. See Figures 4.1 and 4.2. See Table 3.B for recommended wire sizes.



**ATTENTION:** Do not route signal and control wiring in the same conduit with power wiring. This can cause interference with Drive operation. Failure to observe this precaution could result in damage to, or destruction of, the equipment.

Do not route more than three sets of motor leads through a single conduit. This will minimize cross-talk which could reduce the effectiveness of noise reduction methods. If more than three Drive/motor connections per conduit are required, you must use shielded cable. If possible, each conduit should contain only one set of motor leads.



**ATTENTION:** Unused wires in conduit must be grounded at both ends to avoid a possible shock hazard caused by induced voltages. If a Drive sharing a conduit is being serviced or installed, all Drives using this conduit should be disabled to eliminate the possible shock hazard from cross coupled motor leads. Failure to observe these precautions could result in bodily injury.

- Step 2. Connect the AC output power motor leads to terminals U, V and W on the power terminal strip.
- Step 3. Tighten terminals U, V, and W to the proper torque as shown in Table 3.D.

## Grounding

Use the following steps to ground the Drive:



**ATTENTION:** You are responsible for conforming with all applicable local, national and international codes when grounding the Drive. Failure to observe precautions and meet code could result in equipment damage or personal injury.

- Step 1. Remove the Drive's cover.
- Step 2. Run a suitable equipment grounding conductor unbroken from the Drive's ground terminal to the motor's ground terminal and then to earth ground. Refer to Figures 4.1, 4.2 and 5.1.
- Step 3. Run a suitable grounding connector to the motor frame and transformer (if used).
- Step 4. Re-attach the Drive's cover

## Final Installation Checks

### Introduction

Chapter 6 provides a guide to help you run a final check of the 1302 Drive installation.



**ATTENTION:** Only qualified personnel familiar with the 1302 Drive and associated machinery should perform troubleshooting or maintenance functions on the Drive. Failure to comply may result in personal injury and/or equipment damage.

---

### Power Off Checks

Perform the following checks of the Drive installation with the power off:



**ATTENTION:** DC bus capacitors retain hazardous voltage after input power has been disconnected. Disconnect and lock out power to the Drive and wait five (5) minutes for the DC bus capacitors to discharge. Failure to disconnect power could result in death or serious injury. Verify bus voltages using the procedure in Chapter 9 before beginning any checks.

---

- Step 1. Turn off, lock out, and tag the input power to the Drive. Wait 5 minutes.
  - Step 2. Check the DC bus potential with a voltmeter as described in Chapter 9 to ensure that the DC bus capacitors are discharged.
  - Step 3. If an input disconnect is installed, make sure it is in the **OFF** position.
  - Step 4. Make certain that all Drive interlocks installed around the driven machine are operational.
- 



**ATTENTION:** You must provide an external emergency stop circuit outside the Drive circuitry to remove AC line power to the Drive. This circuit must disable the system in case of improper operation. Failure to observe this precaution could result in equipment damage, bodily injury or death. When AC input power is removed, there will be a loss of inherent regenerative braking effect and the motor will coast to a stop. An auxiliary braking method may be required.

---

Spare Allen-Bradley Parts

Step 5. Verify that the user-installed stop pushbutton is wired correctly. Make certain the factory-installed jumper at terminals 10 and 11 has been removed so that the coast-stop pushbutton will work (Refer to Chapter 5).



**ATTENTION:** Check that electrical commons are not intermixed in the Drive. Failure to observe this precaution could result in damage to, or destruction of, the Drive or process equipment.

---

Step 6. Remove any debris from around the Drive.

Step 7. Check that there is adequate clearance around the Drive.

Step 8. Verify that the wiring to the control terminal strip and power terminals is correct per Chapter 5.

Step 9. Check that the wire sizes are within terminal specifications and that the terminals are tightened to the appropriate torque specifications as specified in Chapter 3.

Step 10. Check that user supplied branch circuit protection is installed and correctly rated.

Step 11. Check that the incoming AC power is rated correctly.

Step 12. Check the motor installation and length of motor leads per the guidelines in Chapter 3.

Step 13. Disconnect any power correction capacitors connected between the Drive and the motor.

Step 14. Check that any motor thermal switch and the Drive's electronic thermal overload are enabled (parameter F-15 = ON).

Step 15. Check that the rating of the transformer (if used) matches the Drive requirements and is connected for the proper voltage.

Step 16. Verify that a properly-sized ground wire is installed and that a suitable earth ground is used. Check for and eliminate any grounds between the motor frame and the motor power leads. Verify that all ground leads are unbroken.

Step 17. Uncouple the motor from any driven machinery to initially start the Drive.





## Operational Checks

Use the following procedure to check the operation of the Drive:




**ATTENTION:** DC bus capacitors retain hazardous voltage after input power has been disconnected. Disconnect and lock out power to the Drive and wait five (5) minutes for the DC bus capacitors to discharge. Failure to disconnect power could result in death or serious injury. Verify bus voltages using the procedure in Chapter 9 before beginning any checks.



- Step 1. Turn off, lock out, and tag the input power to the Drive. Wait 5 minutes.
- Step 2. Remove the cover and check the DC bus potential with a voltmeter as described in Chapter 9. Verify that the DC bus capacitors are discharged. Replace the cover.
- Step 3. Uncouple the driven equipment from the motor, if possible.
- Step 4. Apply power to the Drive. **SELF** should be displayed for approximately 1 to 2 seconds to indicate internal diagnostics are being performed. After 1 to 2 seconds, **0** should be displayed and the LEDs should indicate Drive status. If any fault codes are displayed, refer to Chapter 9, Troubleshooting Reference.
- Step 5. Check all parameter settings and verify that they are set correctly based on the application. In most cases, the factory default values are adequate for this no-load start-up test. Parameters are described in Chapter 8.
- Step 6. Press the  key. The Drive should ramp at the acceleration rate (F-01) until it reaches the preset minimum speed (F-03).
- Step 7. Verify the direction of the motor shaft rotation. If it is incorrect for your application, use the following procedure to change the direction of rotation. If it is correct, go to step 8.
  - Step A. Press the  key to stop the Drive.
  - Step B. Wait until the motor has completely stopped.
  - Step C. Turn off, lock out, and tag power to the Drive. Wait five minutes.
  - Step D. Remove the cover and check the DC bus potential with a voltmeter as described in Chapter 9. Verify that the DC bus capacitors are discharged. Replace the cover.

# Spare Allen-Bradley Parts

Step E. Reverse any two of the three motor power leads (U, V, or W).

Step F. Turn the power on.

Step G. Press the  key and verify the direction of rotation.


Step 8. Using the  and  keys, run the motor without any load across the speed range. If the motor does not operate satisfactorily, check the parameter settings. Refer to Chapter 8.

Step 9. Press the  key to stop the Drive.

Step 10. Turn off, lock out, and tag power to the Drive. Wait five minutes. Remove the cover and check the DC bus potential with a voltmeter as described in Chapter 9. Verify that the DC bus capacitors are discharged. Replace the cover.

Step 11. Couple the driven equipment to the motor.

Step 12. Turn power on.

Step 13. Press the  key.

Step 14. Run the Drive across the required speed range under load. If the motor does not rotate at minimum speed, increase the manual torque boost (F-06).

Step 15. If the Drive operates the motor properly, go to step 16.

Step A. Refer to Chapter 9, Troubleshooting Reference, if any fault codes were displayed during start up.

Step B. Verify the parameter settings again.

Step 16. If the Drive operates the motor properly:

Step A. Press the  key to stop the Drive.

Step B. Record the parameter settings in Appendix B.

## Display and Keypad Operation

### Introduction

The Keypad and Display unit shown in Figure 7.1 is used to program, monitor and control the Drive. The Keypad and Display unit operates in two modes: Monitor Mode and Program Mode.

In Monitor Mode (the default mode), you can monitor specific Drive outputs and the Drive's speed reference.

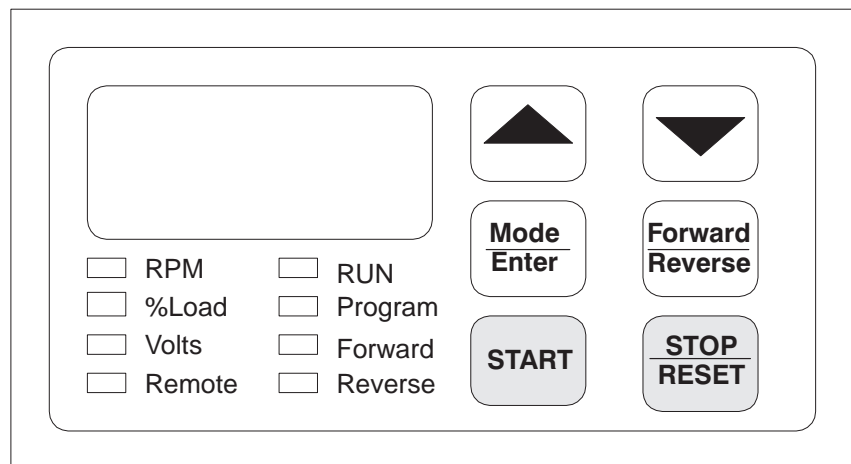
In Program Mode, you can view and adjust Drive parameter values and examine the error log.

In addition to the functions above, if the control source is local (F-00 = 0), you use the keypad to start and stop the Drive, select motor direction, and adjust speed.

Regardless of the control source selected, you can use the keypad to stop the Drive and reset Drive faults.

The following sections describe the keypad, the display, and the LEDs. Monitor mode and program mode are described in more detail later in this chapter.

**Figure 7.1**  
1302 Keypad and Display



### Display Description





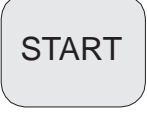

The display is a four-character, seven-segment LED. At Drive power up, SELF is displayed while the Drive performs power-up diagnostics. During Drive operation, the display indicates parameter numbers, parameter values, fault codes, and Drive output values. Figures 7.3 and 7.4 show sample displays.

Spare Allen-Bradley Parts

## Key Description

The keypad's six membrane keys are used to monitor, program, and control the Drive. Table 7.A describes the keys.

**Table 7.A - Key Descriptions**

 	<p>Use the UP and DOWN arrow keys to:</p> <ul style="list-style-type: none"> <li>• Step through the Drive parameters and error log when the Drive is in program mode.</li> <li>• Increase or decrease a parameter's numeric value or status in program mode.</li> <li>• Increase or decrease the internal speed reference when F-00 (Control Source Select) = 0 or 2.</li> </ul> <p>Hold down these keys to increase the scroll speed.</p>
	<p>Use the MODE/ENTER key to:</p> <ul style="list-style-type: none"> <li>• Advance through each monitor display item in monitor mode.</li> <li>• Select program mode when the Drive is stopped.</li> <li>• Display a parameter value in program mode.</li> <li>• Save a parameter value in program mode.</li> </ul> <p>The MODE/ENTER key provides these functions regardless of the control source selected (local or remote).</p>
	<p>Use the FORWARD/REVERSE key to select the direction of motor shaft rotation when the control source is local (F-00 = 0).</p>
	<p>Use the START key to apply power to the motor when the control source is local (F-00 = 0).</p> <p>When this key is pressed, and there are no active faults, the Drive will accelerate to the last programmed frequency setpoint (speed).</p>
	<p>Use the STOP/RESET key to:</p> <ul style="list-style-type: none"> <li>• Turn off the Drive output to the motor if the Drive is running.</li> <li>• Clear drive faults when the Drive is in program mode.</li> <li>• Exit program mode.</li> </ul> <p>When this key is pressed, the Drive will ramp to rest at a user-defined rate (user option) or coast to rest (default). This key stops the Drive regardless of the selected control source (remote or local).</p>

## LED Descriptions

The keypad area contains eight LEDs that indicate either Drive status or which Drive output value is displayed in monitor mode. Tables 7.B and 7.C describe the Drive status LEDs and monitor mode LEDs, respectively.

**Table 7.B - Drive Status LED Descriptions**


LED	State	Description
■ Run	On	The Drive is generating an output voltage and frequency.
	Off	The drive is not generating an output voltage and frequency.
		 <p><b>ATTENTION:</b> DO NOT use the RUN LED as an indication that no line voltage is present in the Drive. Verify there is no voltage present at the DC bus terminals (+) and (-) before servicing the Drive. Failure to observe this precaution could result in severe bodily injury or loss of life.</p>
■ Program	On	The keypad and display are in program mode.
	Off	The keypad and display are in monitor mode.
■ Forward	On	The requested motor rotation direction is forward.
	Off	The requested motor rotation direction is not forward.
■ Reverse	On	The requested motor rotation direction is reverse.
	Off	The requested motor rotation direction is not reverse.
■ Remote	On	The Drive is being controlled from the terminal strip.
	Off	The Drive is being controlled from the keypad.

Table 7.C - Monitor Mode LED Descriptions


LED	Corresponding Display When LED is On (Actual Value)
■ RPM/Engineering Unit	Motor speed in RPM or in a user-specified engineering unit. (Refer to the F-08 parameter description for more information.)
■ %Load	Percentage of Drive full load amps rating.
■ Volts	Drive output voltage to the motor.
All LEDs (RPM, %Load, Volts)	Value of the active speed reference signal as 0 to 100% of the total scaled reference range. F-13 must be set to ON to display this value. (Refer to the F-13 parameter description for more information.)


## Program Mode

Program mode allows you to display and modify Drive parameter values when the Drive is stopped. The following can be displayed in program mode:

- Parameter numbers
- Parameter values
- Error log information

### To enter program mode:

Step 1. Stop the Drive (if it is running) by pressing the  key.

Step 2. Press the  key until the PROGRAM LED turns on.



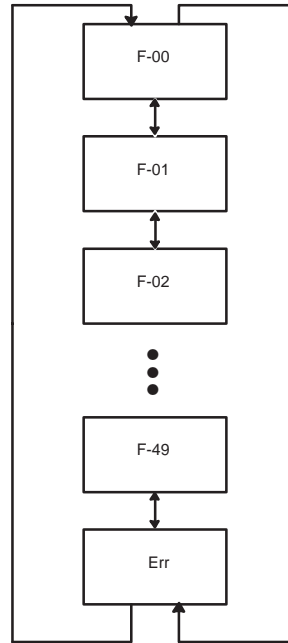


Parameter F-00 will be displayed. Use the  key or  key to scroll through the parameter list. The error log follows parameter F-49 and precedes parameter F-00 as shown in Figure 7.2.


Figure 7.2 - 1302 Menu Structure



**To exit program mode:**

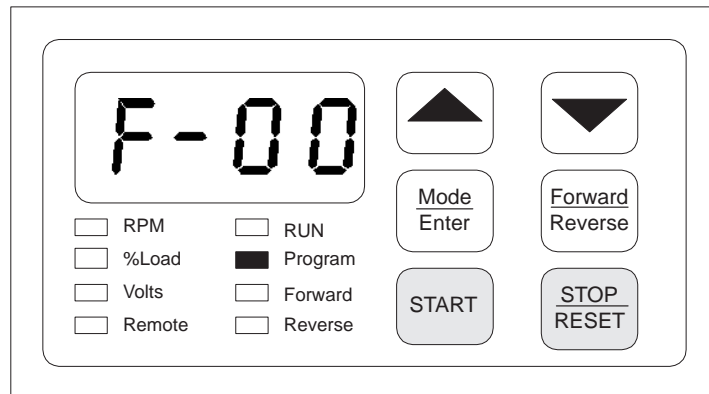
Step 1. Press the  key until a parameter number or ERR is displayed.

Step 2. Press the  key until the PROGRAM LED turns off.

**Important:** Pressing the  key while you are examining the error log clears the log.

A sample program mode display is shown in Figure 7.3.

Figure 7.3 - Example of a Program Mode Display





For information about:	Refer to chapter:
Displaying or changing parameter values	8
Ensuring program security	8
Individual parameters	8
Accessing the error log	9

## Monitor Mode

Monitor mode is the keypad and display's default mode of operation (in other words, the keypad and display will return to monitor mode when you exit program mode). The keypad and display must be in monitor mode before the Drive can be put into run (RUN LED is on) and will remain in monitor mode while the Drive is running.

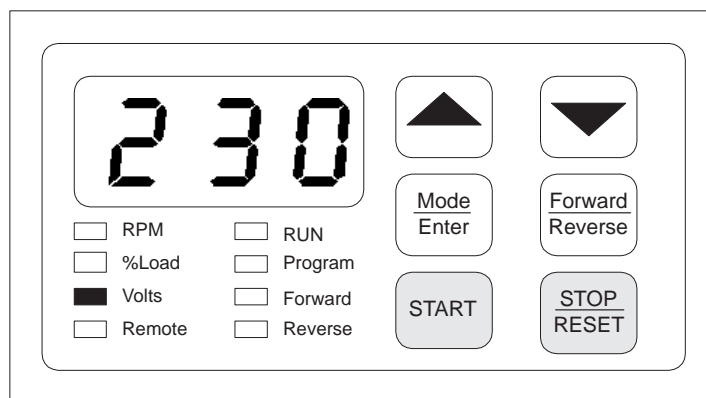
The following output data can be displayed in monitor mode:

- RPM
- % Load
- Volts
- Percent Selected Speed Reference (if F-13 = ON)

To select a value to monitor, press the  key until the LED turns on next to the desired display item. Pressing the  key will advance you through each of the displays. (Note that all the LEDs will turn on to indicate the percent selected speed reference display if parameter F-13 is set to ON. Refer to the scaling the rpm section of this Chapter.)

A sample monitor mode display is shown in Figure 7.4.

**Figure 7.4 - Example of a Monitor Mode Display**







### Displaying the Percent Selected Speed Reference

To display the percent selected speed reference, parameter F-13 must be set to ON. Use the following procedure to display the percent selected speed reference:


Step 1. Stop the Drive (if it is running) by pressing the  key.

Step 2. Enter program mode by pressing the  key until the PROGRAM LED turns on.


Step 3. Press the  or  key until F-13 is displayed.


Step 4.. Press the  key to access the parameter.

Step 5.. Press the  key until ON is displayed.

Step 6.. Press the  key to save the value. (F-13 will be displayed.)

Step 7.. Press the  key to exit program mode.

Step 8.. Start the Drive by pressing the  key.

Step 9.. Press the  key until all three monitor mode LEDs are on.

The display will show the active speed reference as 1 to 100% of maximum speed (F-04).

### Scaling the RPM Display and Reference Using F-08

The RPM display and reference can be scaled to an engineering unit to match your application. Refer to the F-08 description in Chapter 8 for this procedure.

## Drive Control

When the control source is the local keypad (F-00 = 0), the keypad is used to control the Drive. This means that the Drive will respond to START, STOP/RESET, and FORWARD/REVERSE commands only from the keypad. The functions of the keypad keys are described in section 7.2. Refer to the F-00 Control Source Select parameter description in Chapter 8 for more information on selecting a Drive control source.

### Changing the Reference Using the Keypad

The speed reference can be increased or decreased using the ▲ or ▼ key when F-00 = 0 or 2. The display will show the internal speed reference in hertz (Hz) while the keys are pressed. There will be a slight delay before the display returns to the active monitor mode.

Note that changing the drive's internal speed reference using the ▲ or ▼ key when the Drive is under remote control will have no operational effect on the Drive (unless F-00 = 2).


## Programming


### Introduction

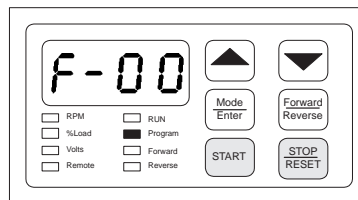
To program the 1302 Drive for a specific application, you display the appropriate parameter and adjust it as required. The parameters specify characteristics of the Drive. This chapter describes how to access, display, and modify parameters. Parameters are described in detail later in this chapter. Appendix C lists the parameters in alphabetical order.

### Displaying or Changing Parameter Values

Use the following procedure to display or change parameter values:

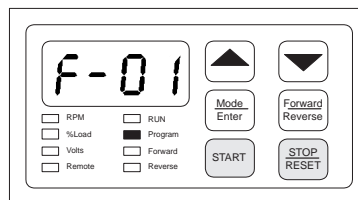
Step 1. Stop the Drive (if it is running) by pressing the  key.

Step 2. Enter program mode by pressing the  key until the PROGRAM LED turns on.




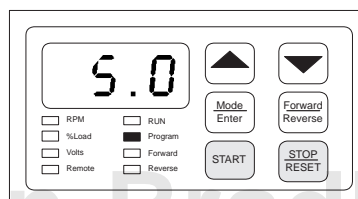
The first parameter number (F-00) will be displayed.

Step 3 Press the  or  key until the desired parameter number is displayed.

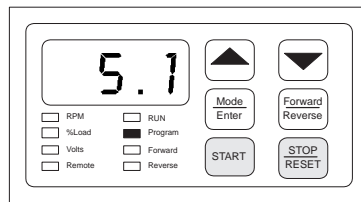


Each parameter number will be displayed as you scroll through the parameter list.

Step 4. Press the  key to display the parameter value.

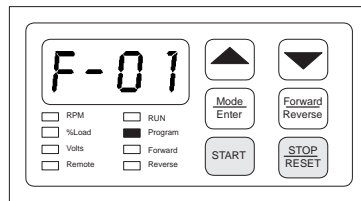


Step 5 .Press the ▲ or ▼ key to change the value.





Note that if programming has been disabled in parameter F-20 (Password Lockout Enable), the value will not change. Refer to Chapter 8, Ensuring Program Security, for more information.

Step 6. Press the  key to save the changed value.



The parameter number is displayed again.

**To display or change additional parameters,** repeat steps 3 through 6.

**To exit program mode,** press the  key until a parameter number or ERR is displayed; then press the  key.

**Important:** Parameter values and the keypad status (local or remote) are retained through a line dip or power loss.

## Program Security



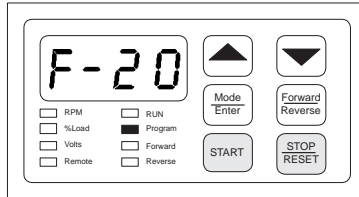
**ATTENTION:** It is your responsibility to determine how to distribute the password. Allen-Bradley is not responsible for unauthorized access violations within the user's organization. Failure to observe this precaution could result in equipment damage or bodily injury.

Parameter values can be password-protected using parameter F-20 (Password Lockout Enable). When F-20 is set to ON, parameter values can be displayed but cannot be modified from the keypad unless the correct password is entered in F-20.

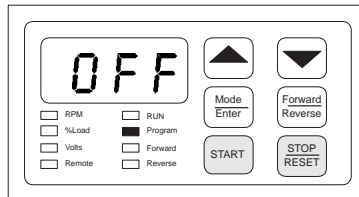
**Note:** The password is factory set to 257 and cannot be modified by the user.

Use the following procedure to disable or enable parameter programming:

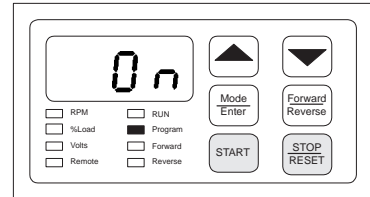
Step 1. In program mode, press the ▲ or ▼ key until F-20 is displayed.



Step 2. Press the Mode Enter key to access the parameter. ON or OFF is displayed to indicate whether the password lockout feature is currently enabled or disabled.

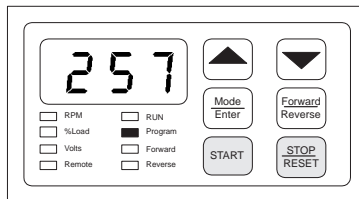


Programming Enabled

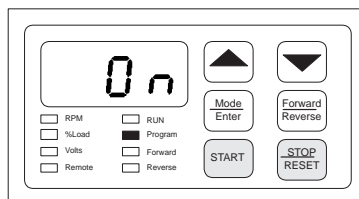


Programming Disabled

Step 3. Press the ▲ key until the password number, 257, is displayed. (Holding down the ▲ key increases the scroll speed.)

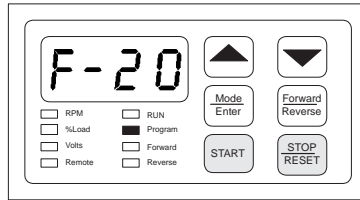


Step 4. Press the Mode Enter key to save the password number.



ON or OFF is displayed to indicate the current state of the password lockout.

Step 5. Press the  key to exit the parameter.



**Important:** There is no visual indication of the status of this feature. You must access F-20 to verify its current value (ON or OFF).

## Parameter Descriptions

### Displaying or Changing Parameter Values

#### F-00 Control Source Select

This parameter selects the Drive control source and speed reference source.

<b>Parameter Range:</b>	0 =	Local control; control signals and speed reference from the keypad
	1 =	Remote control; control signals from the terminal strip; speed reference from the analog input
	2 =	Remote control; control signals from the terminal strip; speed reference from the keypad
	3 =	Remote control; control signals from the terminal strip; multi-speed presets from the terminal strip
<b>Default Setting:</b>	0 =	Local control
<b>Step Size:</b>		N/A

When F-00 = 0, the Drive responds to sequencing commands (start, stop, forward, reverse) from only the keypad.

When F-00 = 1, 2, or 3, the Drive responds to sequencing commands from the terminal strip. Note that the drive will respond to the stop command from the keypad regardless of the value in this parameter.

Refer to the F-23 to F-25 Multi-Speed Presets parameter description for more information about multi-speed presets.

## F-01 Acceleration Time

This parameter specifies the amount of time it takes the motor to ramp from stop to the maximum speed setting in F-04.

<b>Parameter Range:</b>	0.5 to 90 seconds
<b>Default Setting:</b>	5.0 seconds
<b>Step Size:</b>	0.10 seconds

If the setpoint frequency requested from the keypad (using the ▲ and ▼ keys) is less than the maximum speed setting, the time to ramp to that frequency will be proportionally less than the actual rate setting. For example, if F-04 = 60 Hz and F-01 = 4 seconds, it will take 2 seconds to ramp to a frequency reference of 30 Hz.

Note that if the acceleration rate is set too fast, an overcurrent fault may occur (OC will be displayed).

## F-02 Deceleration Time

This parameter specifies the amount of time it takes the motor to ramp from the maximum speed setting in F-04 to a stop.

<b>Parameter Range:</b>	0.5 to 90 seconds
<b>Default Setting:</b>	5.0 seconds
<b>Step Size:</b>	0.10 seconds

If the frequency requested from the keypad (using the ▲ and ▼ keys) is less than the maximum speed setting, the time to ramp to that frequency will be proportionally less than the actual rate setting. For example, if F-04 = 60 Hz and F-02 = 4 seconds, it will take 2 seconds to ramp to a frequency reference of 0 Hz from 30 Hz.

Note that if the deceleration rate is set too fast, a high bus fault may occur (HU will be displayed).

## F-03 Minimum Speed

This parameter limits the speed reference to the Drive. Regardless of what speed reference is supplied, the regulator will not command a speed less than the value in F-03.

<b>Parameter Range:</b>	0.5 to 30 Hz
<b>Default Setting:</b>	5.0 Hz
<b>Step Size:</b>	0.10 Hz if F-04 < 100 Hz 0.25 Hz if F-04 ≥ 100 Hz



**ATTENTION:** The 1302 Drive is intended to operate the motor at a predetermined minimum speed unless disconnected from the power source. The user is responsible for assuring safe conditions for operating personnel by providing suitable guards, audible or visual alarms, or other devices to indicate that the drive is operating at minimum speed, (possibly zero speed), or the user must verify that the motor output shaft will rotate at all combinations of load and output speed required by the application.

## F-04 Maximum Speed

This parameter limits the speed reference to the Drive. Regardless of what speed reference is supplied, the regulator will not command a speed greater than the value in F-04.

<b>Parameter Range:</b>	30 to 240 Hz
<b>Default Setting:</b>	60 Hz
<b>Step Size:</b>	0.10 Hz if F-04 < 100 Hz 0.25 Hz if F-04 ≥ 100 Hz



**ATTENTION:** The user is responsible for ensuring that driven machinery, all drive-train mechanisms, and process line material are capable of safe operation at maximum speed (F-04). Failure to observe this precaution could result in bodily injury or equipment damage.

## F-05 Current Limit

This parameter limits motor output torque while it is running or accelerating.

<b>Parameter Range:</b>	10% to 150% of rated drive current
<b>Default Setting:</b>	150%
<b>Step Size:</b>	1.0%

When output current attempts to exceed the preset current limit, motor current will be maintained or reduced, or the acceleration / deceleration time will be extended. If current limit is set too low or too high relative to the required load, an overcurrent fault may occur (OC will be displayed).



## F-06 Manual Torque Boost

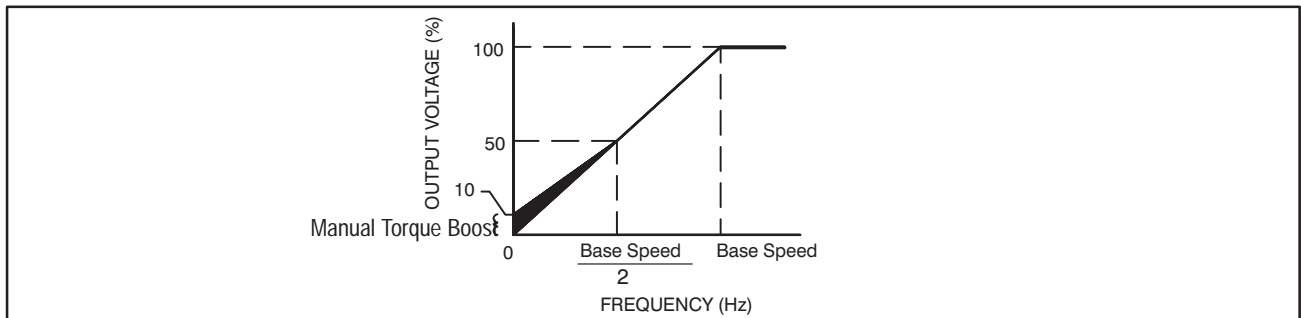
This parameter sets the percentage of output voltage boost at zero frequency.

<b>Parameter Range:</b>	0 to 10%
<b>Default Setting:</b>	2%
<b>Step Size:</b>	1%

Torque boost offsets the voltage drop of the AC motor at low speeds. For high friction loads or high inertia loads, a high starting torque level may be needed. Manual torque boost is only effective at speeds lower than one-half of the motor's base frequency. See Figure 8.1.

When adjusting this parameter, start with the default setting of 2% and gradually increase the value until motor operation is satisfactory. If torque boost is set too high relative to the load and acceleration rate, an overcurrent fault may occur (OC will be displayed).

Figure 8.1 - Manual Torque Boost Adjustment Range



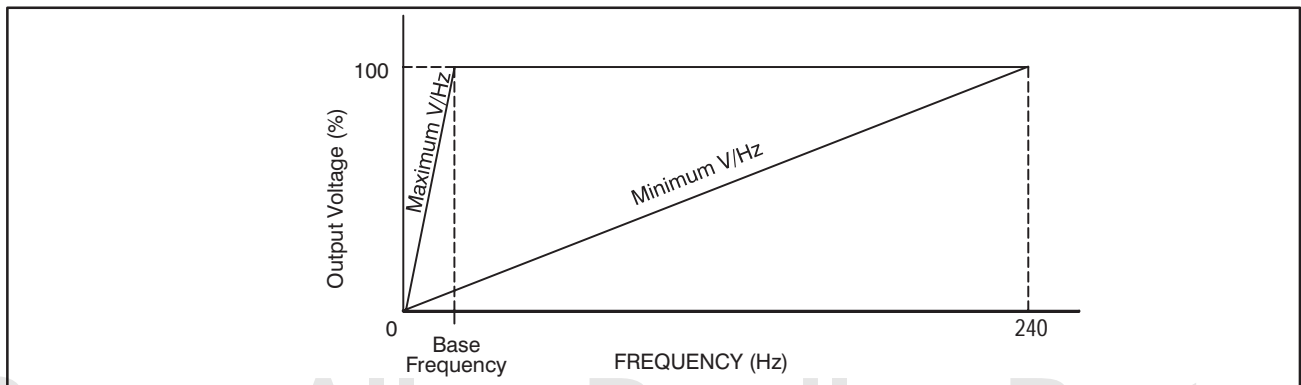
## F-07 V/Hz (Base Speed)

This parameter specifies the base speed at maximum output voltage and is used to establish the volts/hertz (V/Hz) curve.

<b>Parameter Range:</b>	30 to 240 Hz
<b>Default Setting:</b>	60 Hz
<b>Step Size:</b>	1.0 Hz

The V/Hz curve allows the Drive to maintain a constant V/Hz ratio, providing constant torque at any frequency. See Figure 8.2.

Figure 8.2 - Volts/Hertz Curve



Spare Allen-Bradley Parts

## F-08 RPM at Base Speed

This parameter scales the RPM display and the setpoint to a user-specified engineering unit.

<b>Parameter Range:</b>	10 to 9999
<b>Default Setting:</b>	1750
<b>Step Size:</b>	1.0 unit

This parameter defines the scaling value applied to the current speed before it is displayed. It is also used to scale the local reference when F-18 is set to ON.

The value to enter into F-08 is the maximum value (in RPM, hertz, or any other engineering unit) to be displayed when the Drive is running at base speed (F-07).

### Display Scaling Examples

**Example 1:** Assume that an application requires the display show 1750 RPM when the drive is running at a base speed of 60 Hz. The RPM display is scaled according to the following equation:

$$\text{Present Operating Speed (Hz)} \times \frac{\text{F-08}}{\text{F-07}} = \text{Displayed Value}$$

At 30 Hz, the RPM display will show 875:

$$30 \text{ Hz} \times \frac{1750}{60} = 875$$

**Example 2:** Assume the application requires the display show 20 feet per minute for a conveyor (or 20 gallons per minute for a pump) when the motor is running at base speed (F-07= 60 Hz). Enter 20 in parameter F-08 to scale the display.

At 30 Hz, the display will show 10 feet (or gallons) per minute:


$$30 \text{ Hz} \times \frac{20}{60} = 10$$

## F-09 Configurable Output Relay Select

This parameter specifies the type of status indication the output relay contacts provide (terminals 14, 15, and 16 on the Drive terminal strip).

<b>Parameter Range:</b>	0 = Output relay is energized to show state of Drive running.
	1 = Output relay is energized to show state of active fault (IET).
	2 = Output relay is energized to show state of Drive running at speed.
<b>Default Setting:</b>	0
<b>Step Size:</b>	N/A

If F-09 = 0, the output is energized only when the RUN LED is on.

If F-09 = 1, the output remains energized until the fault is cleared by pressing the  key (in local operation) or by using the remote IET reset signal (for remote operation).

If F-09 = 2, the output is energized when the Drive is running and at speed.

## F-10 Carrier Frequency

This parameter selects the Drive's carrier frequency.

<b>Parameter Range:</b>	4 = 4 kHz Carrier frequency
	6 = 6 kHz Carrier frequency
	8 = 8 kHz Carrier frequency
<b>Default Setting:</b>	4
<b>Step Size:</b>	N/A

The carrier frequency controls the width of the pulse and keeps the current smooth to the motor. This parameter can compensate for acoustic noise, heating, and other current problems by adjusting the switching frequency of the transistors in the inverter section.

Keeping the carrier frequency at 4kHz maximizes the continuous power rating of the Drive with, generally, an acceptable acoustic noise level from the motor. Increasing the carrier frequency reduces the acoustic noise, but in some applications this can result in derating of the Drive output amps.

# Spare Allen-Bradley Parts

## F-11 Remote Reference Gain

This parameter scales the maximum remote speed reference to match external equipment.

<b>Parameter Range:</b>	60% to 100% of full scale maximum reference
<b>Default Setting:</b>	100%
<b>Step Size:</b>	0.10%

Normally, the maximum speed reference (the amount of reference at maximum speed, F-04) is either 10 VDC or 20 mA. The reference gain is used to scale the speed reference to another value (for example, 9.5 VDC or 19 mA). Enter the parameter value in percent of full scale reference.

To calculate the scaled reference if you are using a **0 to 20 mA remote reference**, use the following equation:

$$\frac{\text{Desired Maximum Reference (mA)}}{\text{Reference Range (20)}} \times 100 = \% \text{ gain (mA reference)}$$

### Example

If the remote speed reference is 0 to 20 mA and the maximum reference required is 19.2 mA, scale as follows:

$$\frac{19.2}{20} \times 100 = 96\% \text{ gain}$$

To calculate the scaled reference if you are using a **0 to 10 VDC remote reference**, use the following equation:

$$\frac{\text{Desired Maximum Reference (VDC)}}{\text{Reference Range (10)}} \times 100 = \% \text{ gain (VDC reference)}$$

### Example

If the remote speed reference is 0 to 10VDC and the maximum reference required is 9.5 VDC, scale as follows:

$$\frac{9.5}{10} \times 100 = 95\% \text{ gain}$$

## F-12 Remote Reference Offset

This parameter scales the remote speed reference (0 to 10VDC or 0 to 20 mA) to a minimum value.

<b>Parameter Range:</b>	0% to 40% of full scale minimum reference
<b>Default Setting:</b>	0%
<b>Step Size:</b>	0.10%

Typically, the value of the minimum speed reference (the amount of reference at minimum speed, F-03) is either 0 VDC or 0 mA. Enter the parameter value as a percentage of the full scale reference to be offset from minimum speed.

To calculate the scaled minimum reference, use the following equation:

$$\frac{\text{Desired Minimum Speed Offset}}{\text{Reference Range}} \times 100 = \% \text{offset}$$

### Scaling Examples

**Example 1:** If the remote analog input speed reference is 0 to 20 mA (J6 set on terminals 2 and 3), and the available analog reference signal is 4 to 20 mA, use F-12 to obtain minimum speed with minimum analog input as follows:

$$\frac{4}{20} \times 100 = 20\% \text{ offset}$$


**Example 2:** If the remote analog input speed reference is 0 to 10 VDC (J6 set on terminals 1 and 2), and the available signal is offset 0.4 VDC, use F-12 to obtain minimum speed with minimum analog input as follows:

$$\frac{0.4}{10} \times 100 = 4\% \text{ offset}$$

## F-13 Percent Selected Speed Reference Display Enable

This parameter enables or disables the fourth monitor mode display.

<b>Parameter Range:</b>	ON = Fourth monitor mode display is enabled.
	OFF = Fourth monitor mode display is disabled.
<b>Default Setting:</b>	OFF
<b>Step Size:</b>	N/A

If F-13 = ON, the current value of the active speed reference can be displayed by pressing the  key (while the Drive is running) until all three monitor mode LEDs are on. The active speed reference is displayed as 1 to 100% of maximum speed (F-04).

If F-13 = OFF, the active speed reference will not be displayed.

Refer to Chapter 3 for more information on the monitor mode displays.

# Spare Allen-Bradley Parts

## F-14 Electronic Thermal Overload

This parameter sets the trip level for the electronic thermal overload fault (OL) when F-15 = ON.

<b>Parameter Range:</b>	20% to 100% rated current
<b>Default Setting:</b>	100%
<b>Step Size:</b>	1%

This parameter should be adjusted if the motor current rating is less than the Drive current rating.

Use the formula below to calculate the setting level as a percentage of maximum continuous current:

$$F-14 = \frac{\text{Motor Full Load Current}}{\text{Drive Output Rated Current}} \times 100$$

The motor full load current value can be found on the motor nameplate. See Table 2.A or the Drive nameplate for the Drive rated output value.

## F-15 Electronic Thermal Overload Enable

This parameter enables or disables the electronic motor thermal overload function. This function operates like a motor thermal switch to protect the motor from overheating.

<b>Parameter Range:</b>	OFF = No electronic thermal overload protection.
	ON = Electronic thermal overload protection is active.
<b>Default Setting:</b>	ON
<b>Step Size:</b>	N/A



**ATTENTION:** Parameter F-15 must be set to ON in single motor applications to guard against damage from overheating or combustion of surrounding materials. Failure to observe this precaution could result in fire or damage to or destruction of the motor and the drive.

When F-15 = ON, the Drive faults if it exceeds the thermal overload time (60 seconds at 150% of F-14). When an external thermal switch or other overtemperature monitoring device is connected to the function loss circuit (terminals 10 and 11), this parameter may be set ON or OFF.

For multi-motor applications, set this parameter to OFF. The individual motors must have thermal switch protection.

## F-16 Coast Stop Enable

This parameter selects how the motor will stop when given a stop command.

<b>Parameter Range:</b>	ON = Enable coast stop (motor will coast to rest)
	OFF = Disable coast stop (motor will ramp to rest)
<b>Default Setting:</b>	OFF
<b>Step Size:</b>	1%



**ATTENTION:** You must provide an external, hardwired emergency stop circuit outside of the drive circuitry. This circuit must disable the system in case of improper operation. Uncontrolled machine operation may result if this procedure is not followed. Failure to observe this precaution could result Drive or equipment damage, bodily injury or death!

A coast-to-rest stop turns off the transistor power device drivers. A ramp-to-rest stop fires the transistor power device drivers until the motor comes to a stop and then turns off the power device drivers.


Note that the function loss input opening or a Drive fault will always cause a coast-to-rest stop.

## F-17 Reverse Disable

This parameter enables or disables reverse rotation of the motor.

<b>Parameter Range:</b>	ON = Disable reverse
	OFF = Enable reverse
<b>Default Setting:</b>	OFF
<b>Step Size:</b>	N/A

If F-17 = OFF, the forward/reverse input allows forward or reverse rotation of the motor.

If F-17 = ON, reverse rotation of the motor is prohibited. When F-17 = ON, pressing the  key on the keypad in local control, or wiring to terminal 9 on the terminal strip in remote control, does not affect Drive operation.

# Spare Allen-Bradley Parts

## F-18 RPM Setpoint Enable

The parameter enables the setpoint to be displayed in F-08 units.

<b>Parameter Range:</b>	OFF = Setpoint is displayed in hertz.
	ON = Setpoint is displayed in the units specified in F-08.
<b>Default Setting:</b>	ON
<b>Step Size:</b>	N/A

If F-18 = ON, pressing the ▲ and ▼ keys will change the setpoint in units of 1 between minimum speed in F-08 units and maximum speed in F-08 units. Note that this parameter only affects the setpoint, not the display.

### Example

Assume a Drive is currently running at 60 Hz = 1750 RPM, F-08 = 1750, and F-10 = ON. When the ▼ key is pressed, 1750 is displayed. When the ▼ key is pressed three more times, the display will change from 1750 to 1749 to 1748 to 1747. The reference is then rescaled based on this input:

$$\text{Input reference} = \frac{\text{Reference (1747)}}{\text{F-08 (1750)}} \times \text{F-04 (60Hz)} = 59.89 \text{ Hz}$$

## F-19 Power-Up Start Enable


This parameter determines whether the motor starts automatically when the Drive is powered up.

<b>Parameter Range:</b>	OFF = Motor does not start at Drive power up.
	ON = Motor starts at Drive power up.
<b>Default Setting:</b>	OFF
<b>Step Size:</b>	N/A



**ATTENTION:** Setting F-19 = ON causes output power to be applied to the motor automatically at Drive power up. When this function is enabled, you must ensure that automatic start up of the driven equipment will not cause injury to operating personnel or damage to the driven equipment. In addition, you are responsible for providing suitable audible or visual alarms or other devices to indicate that this function is enabled and the Drive may start at any moment. This parameter may only be used as outlined in NFPA79, paragraph 6-14 (exceptions 1-3) for specialized applications. Equipment damage and/or personal injury may result if this parameter is used in an inappropriate application.

When F-19 = ON, output power is applied to the motor at drive power up if the following conditions are met:

- The drive power-up diagnostics must be passed (SELF will be displayed at power up).
- No faults can be active.
- The terminal strip function loss input must be closed.
- The front-panel keypad  key must not be pressed.

If the Drive is under local control, it will effectively simulate a start signal to start the Drive.

If the Drive is under remote control, the Drive will start only if the terminal strip START input is asserted.



## F-20 Password Lockout Enable

This parameter enables or disables parameter password protection.

<b>Parameter Range:</b>	OFF = Password lockout disabled (parameters can be modified)
	ON = Password lockout enabled (parameters cannot be modified)
<b>Default Setting:</b>	OFF
<b>Step Size:</b>	N/A



**ATTENTION:** It is your responsibility to determine how to distribute the password. Allen-Bradley is not responsible for unauthorized access violations within the user's organization. Failure to observe this precaution could result in equipment damage or bodily injury.

When F-20 = ON, parameter values can be displayed but cannot be modified (except F-20). Entering the factory-set password number (257) toggles the state of the lockout. Refer to Chapter 8, Ensuring Program Security for this procedure.

**Important:** There is no visual indication of the status of this feature. You must access F-20 to verify its current value (ON or OFF).

## F-21 Avoidance Frequency

This parameter specifies the midpoint of the avoidance band selected in F-22.

<b>Parameter Range:</b>	Minimum speed to maximum speed (Hz)
<b>Default Setting:</b>	5.0
<b>Step Size:</b>	0.10 Hz

The avoidance band can help alleviate problems with vibrations/harmonics at a specific operating frequency of the driven motor or machinery. Refer to the F-22 parameter description for more information.

# Spare Allen-Bradley Parts

## F-22 Avoidance Bandwidth

This parameter sets the avoidance bandwidth. Any frequency that falls within the avoidance band results in a generated frequency below the bandwidth.

<b>Parameter Range:</b>	0 to 30 Hz (0 = avoidance frequency disabled)
<b>Default Setting:</b>	0
<b>Step Size:</b>	0.10 Hz

This parameter is used with parameter F-21 (Avoidance Frequency). The Drive can accelerate and decelerate through the avoidance band. However, it cannot operate at a steady state at any of the avoidance band frequencies. Setting F-22 to 0 disables the avoidance frequency.

### Example

Assume:

Minimum Speed (F-03) = 3 Hz  
 Maximum Speed (F-04) = 60.0 Hz  
 Avoidance Frequency (F-21) = 32.2 Hz  
 Avoidance Bandwidth (F-22) = 4 Hz  
 Avoidance band = 30.2 to 34.2 Hz

Requested Output Frequency	Output Frequency After Avoidance Band Correction
25.0 Hz	25.0 Hz
30.0 Hz	30.0 Hz
31.0 Hz	30.2 Hz
32.0 Hz	30.2 Hz
34.0 Hz	30.2 Hz
34.2 Hz	30.2 Hz
34.3 Hz	34.3 Hz
35.0 Hz	35.0 Hz

### F-23, F-24, and F-25 Multi-Speed Presets 1, 2, and 3

These parameters allow the setting of up to three different preset speeds.

<b>Parameter Range:</b>	Minimum speed to maximum speed
<b>Default Setting:</b>	20 Hz
<b>Step Size:</b>	0.10 Hz

Setting F-00 = 3 (multi-speed configuration) reconfigures the terminal strip control inputs as follows:

- Terminal 6 = START/STOP/IET RESET (open = STOP; closed = IET RESET/START)
- Terminal 7 = MSPD 1
- Terminal 8 = MSPD 0

Refer to Chapter 5.

Terminals 7 and 8 are used to select the reference source as shown in Table 8.A

**Table 8.A - Multi-Speed Presets Digital Inputs**

<b>MSPD 1</b>	<b>MSPD 0</b>	<b>Reference Source</b>
Open (0)	Open (0)	Terminal strip analog input (variable speed)
Open (0)	Closed (1)	Multi-Speed #1 (F-23)
Closed (1)	Open (0)	Multi-Speed #2 (F-24)
Closed (1)	Closed (1)	Multi-Speed #3 (F-25)

## F-26 Auto-Restart Number of Attempts

This parameter selects the number of times the Drive will attempt to restart after certain faults have shut down the Drive.

**Parameter Range:** 0 to 10  
**Default Setting:** 0  
**Step Size:** N/A



**ATTENTION:** If parameter F-26  $\neq$  0, the Drive will attempt to restart automatically after auto-restartable drive faults (see Table 8.B) have shut down the Drive. When this feature is enabled, you must ensure that automatic restart of the driven equipment will not cause injury to operating personnel or damage to the driven equipment. This parameter may only be used as outlined in NFPA79, paragraph 6-14 (exceptions 1-3) for specialized applications.

If F-26  $\neq$  0, the Drive logs and resets certain faults (called auto-restartable faults and listed in table 8.2) it detects while running. The Drive then waits the amount of time specified in F-27 (Auto-Restart Retry Wait Time) and restarts the Drive automatically.

While the Drive counts down the auto-restart time period, the display flashes the countdown period (in seconds) in the following format:

“Ar30 .. Ar29 .. Ar28 ..... Ar01 .. Ar00”

This shows the amount of time remaining before the auto-restart takes effect.

Once the Drive restarts, it must run for 5 minutes in order to reset the number of fault reset attempts to the value in F-26.

If the fault occurs again, the Drive decrements the number of auto-restart attempts, counts down the auto-restart time again, and continues the auto-restart process. If the Drive faults on all of these attempts, it remains in the faulted state and displays the fault code for the fault it is trying to clear.

If the Stop/Reset input is asserted during the countdown, the auto-restart procedure is cancelled and the fault is latched.

If a fault occurs that is auto-restartable and other faults are active that are not auto-restartable, the auto-restart function will be disabled until all faults are cleared.

When F-26  $\neq$  0, the drive logs the first occurrence of a fault in the fault log. Any subsequent occurrence of that fault while attempting to restart the Drive will not be logged.

Table 8.B lists the auto-restartable faults.

**Table 8.B - Auto-Restartable Faults**

Fault Code	Description
HU	High bus voltage
LU	Low bus voltage
OC	Overcurrent
OH	Thermostat/drive overload
OL	Electronic thermal overload

## F-27 Auto-Restart Retry Wait Time

This parameter specifies the amount of time the Drive will wait between auto-restart attempts.

<b>Parameter Range:</b>	1 to 30 seconds
<b>Default Setting:</b>	1
<b>Step Size:</b>	1.0 second

This parameter is used with parameter F-26 (Auto-Restart Number of Attempts). Refer to the F-26 parameter description for information regarding this feature.

## F-28 Drive Voltage Selection

This parameter displays the drive's voltage rating.

<b>Parameter Range:</b>	N/A
<b>Default Setting:</b>	N/A
<b>Step Size:</b>	N/A



**ATTENTION:** This parameter is set at the factory and must not be changed by the user. Failure to observe this precaution could result in damage to, or destruction of, the equipment.

## F-29 Analog Output Select

This parameter selects which monitor mode value is directed to the analog output (regardless of which monitor mode value is displayed).

<b>Parameter Range:</b>	SPd = Current RPM/speed output
	LOAd = Current percent load output
	UOL = Current calculated output voltage
	rEF = Current percent of selected reference
<b>Default Setting:</b>	SPd
<b>Step Size:</b>	N/A

Refer to Table A.E in Appendix A for more detail about the analog output.

## F-49 Version Information

This parameter displays the software version.

<b>Parameter Range:</b>	N/A
<b>Default Setting:</b>	N/A
<b>Step Size:</b>	N/A

# Spare Allen-Bradley Parts

**This Page Intentionally Blank**

## Troubleshooting

---



**ATTENTION:** Only qualified personnel familiar with the 1302 Drive and associated machinery should perform troubleshooting or maintenance functions on the Drive. Failure to comply may result in personal injury and/or equipment damage.

---

### Introduction

The 1302 Drive is monitored by internal diagnostics. If a fault occurs, the Drive displays a two-digit fault code to identify the problem. A fault causes the Drive to coast to rest if it is running or prevents the Drive from starting if it is stopped. The fault code is also entered into the error log.

This chapter defines the fault codes and suggests actions to correct problems. It also describes how to access and clear the error log.

**Note:** Refer also to the F-26 (Auto-Restart Number of Attempts) parameter description in Chapter 8. This describes the Drive's reaction to Drive faults if the auto-restart feature is enabled (F-26 p 0).

**Important:** Before servicing the Drive, verify that the DC bus capacitors have discharged as described in the following paragraph. Use an isolated multimeter to measure the DC bus voltage and to make resistance checks. Note that dedicated troubleshooting test points are not provided.

### Verifying DC Bus Voltage



**ATTENTION:** DC bus capacitors retain hazardous voltages after input power has been disconnected. Disconnect and lock out power to the Drive and wait five (5) minutes for the DC bus capacitors to discharge. Failure to disconnect power could result in death or serious injury. Verify bus voltages using the procedure in the following paragraph before beginning any checks.

---

The 1302 Drive's DC bus capacitors retain hazardous voltages after input power has been disconnected. Perform the following steps before touching any internal components:

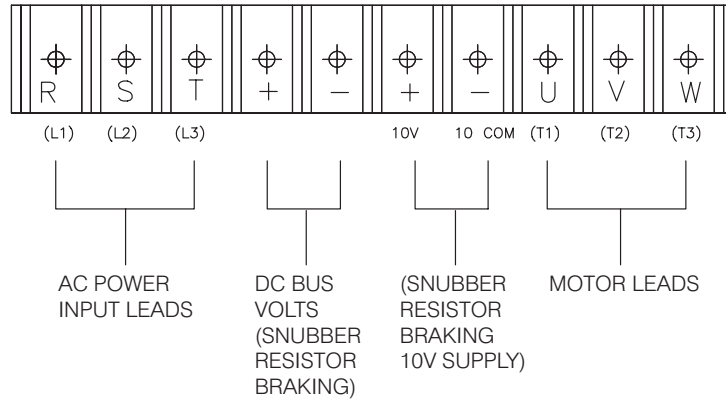
- Step 1. Turn off, lock out, and tag input power to the Drive. Wait five minutes.
- Step 2. Remove the Drive's cover.
- Step 3. Verify that there is no voltage at the Drive's input power terminals.

# Spare Allen-Bradley Parts

Step 4. Measure the DC bus voltage at the DC bus power terminals with a multimeter while standing on a non-conductive surface and wearing insulated gloves (600V). See Figure 9.1.

Once the Drive has been serviced, reattach the Drive's cover and reapply input power.



**Figure 9.1 - DC Bus Terminals**



### Troubleshooting the Drive Using Fault Codes

Table 9.A defines the fault codes for user-correctable faults, lists possible causes, and suggests actions to take to correct the problem. **All other faults require replacement of the drive.**

If a fault occurs, do the following:

- Step 1. Try to clear the fault first by pressing the  key or asserting the IET reset input (remote operation). If the fault reoccurs, continue with step 2.
- Step 2. Refer to Table 9.A to identify the fault code and the possible causes.
- Step 3. Perform the suggested corrective action(s).
- Step 4. Clear the fault by pressing the  key or asserting the IET reset input.

**Table 9.A - Drive Faults and Corrective Actions**

<b>FL = FUNCTION LOSS</b>	
The function loss input signal has been asserted (terminals 10 and 11).	
<b>Possible Cause</b>	<b>Corrective Action</b>
The external equipment connection to the function loss terminals has failed or is giving repeated stop requests.	Check the external equipment wired to the remote function loss terminals (10 and 11). Refer to Chapter 5. Check the function loss input connections.



**HU = HIGH BUS VOLTAGE**

The DC bus is charged above the electronic trip threshold. Note that the fault will not clear until the bus falls below the high bus level.

Possible Cause	Corrective Action
The deceleration rate setting in F-02 is too fast.	Decrease the deceleration rate in F-02. Refer to chapter 8 for the F-02 parameter description. Install the optional snubber resistor braking kit.
The Drive was started into a forward-running load that has a high inertia.	Install the optional snubber resistor braking kit.
High input line.	Verify that the AC input is within specification. Install an isolation transformer if required.

**LU = LOW BUS VOLTAGE**

The DC bus voltage has fallen below the electronic trip low threshold level. Note that the fault will not clear until the input line voltage is within the proper range. This may take a few seconds.

**Important:** If a line dip or momentary power loss occurs and the DC bus is able to rise back to the proper level within 500 ms, the Drive will automatically restart (if the Drive was running when the fault occurred).

Possible Cause	Corrective Action
Loss of input power.	Check incoming power.
Low line voltage.	Check incoming power. Install an isolation transformer if required.

<b>OC = OVERCURRENT</b> The Drive's 200% current rating has been exceeded.	
Possible Cause	Corrective Action
Short in the Drive outputs.	Verify that the Drive's input and output wiring are properly connected. Refer to chapter 5.
Ground fault condition.	Verify that the Drive's input and output wiring are properly connected. Refer to chapter 5. Verify that the output wiring to the motor is not connected to ground or any other voltage source. Refer to chapter 5.
Instantaneous overcurrent resulting in 200% rated Drive current.	Increase the acceleration time in F-01 or the deceleration time in F-02. Refer to chapter 8 for parameter descriptions. Adjust the current limit level in F-05 if it is too low or too high relative to the load. Make the adjustments in 5% increments.
<b>OH = THERMOSTAT / DRIVE OVERLOAD</b> The internal thermostat detected excessive temperatures in the Drive. Note that the fault will not clear until the internal drive temperature is back within range. This may take a few seconds.	
Possible Cause	Corrective Action
The Drive's operating specifications have been exceeded.	Check the application and change the carrier frequency in F-10. Refer to chapter 8 for the parameter description.
The ambient operating temperature of the Drive has been exceeded. See Appendix A.	Check the temperature at the installation site. Move the Drive to a cooler location.


**OL = ELECTRONIC THERMAL OVERLOAD**

The electronic thermal overload trip level has been exceeded. This fault protects the Drive motor from overheating due to excessive current within a specified period. Note that the fault will not clear until the input line voltage is within the proper range. This may take a few seconds.

Possible Cause	Corrective Action
The current limit setting in F-05 is incorrect.	If the current limit level is too low relative to load, increase the current level in F-05. Refer to chapter 8 for the parameter description.
The electronic thermal overload setting in F-14 does not match the motor and Drive combination.	Verify the value of F-14. Refer to chapter 8 for the parameter description.

**r1, r2 = POWER SUPPLY OUT OF RANGE**

The power supply is out of range.

Possible Cause	Corrective Action
Possible regulator failure.	Contact Allen–Bradley for assistance if the fault reoccurs after pressing the  key (or asserting the IET reset input) or cycling power.

**SELU = INVALID DRIVE VOLTAGE**

The value in F-28 is incorrect for the Drive.

Possible Cause	Corrective Action
An invalid Drive voltage was selected in F-28.	Select the voltage to match the input line voltage.


**Accessing and Clearing the Error Log**

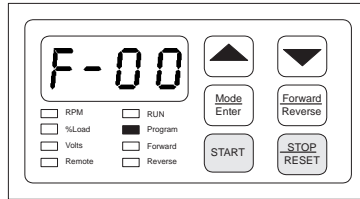
If a fault occurs, the Drive displays a fault code and logs the fault code into the error log. If more than one fault occurs, the first fault flashes on the display and the subsequent faults (up to two) are logged in the error log. After three faults, no subsequent faults are logged.

The faults in the error log are numbered sequentially. For example, if an overcurrent fault occurred first followed by a thermal overload fault, the error log would read 1-OC, 2-OL.

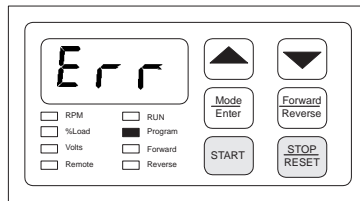
The last fault to occur appears first when the error log is accessed. For example, if the last fault to occur was a low bus fault, and the error log contained three entries, the error log would display 3-LU when the error log is accessed.

Use the following procedure to access the error log:

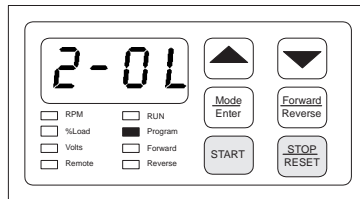
Step 1. Enter program mode by pressing the  key until the PROGRAM LED turns on.




Step 2. Press the  key until ERR is displayed. The error log precedes parameter F-00 and follows F-49.

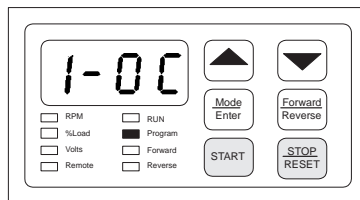


Step 3. Press the  key to access the error log.



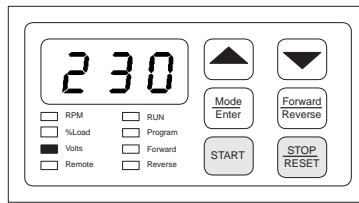
(Sample Display)

Step 4. Press the  key to move through the error codes.



(Sample Display)

Step 5. Press the  key to clear the log.



The display will return to the active monitor display.

## Power Module Check

If a fault occurs, the Drive displays a fault code and logs the fault code into the error log. If more than one fault occurs, the first fault flashes on the display and the subsequent faults (up to two) are logged in the error log. After three faults, no subsequent faults are logged.



**ATTENTION:** DC bus capacitors retain hazardous voltage after input power has been disconnected. Disconnect and lock out power to the Drive and wait five (5) minutes for the DC bus capacitors to discharge. Failure to disconnect power could result in death or serious injury. Verify bus voltages using the procedure in Chapter 9 before beginning any checks.

Use the following procedure to check the Drive's Power Module circuitry. Note that this test is performed with the power off.

- Step 1. Turn off and lock out input power. Wait five minutes.
- Step 2. Remove the Drive's cover.
- Step 3. Verify that there is no voltage at the Drive's input power terminals
- Step 4. Check the DC bus voltage with a voltmeter as described in Chapter 9 to ensure that the DC bus capacitors are discharged.
- Step 5. Disconnect the motor from the Drive.
- Step 6. Check all AC line and DC bus fuses.
- Step 7. If a fuse is open, use a multimeter to check the input diodes and output IGBTs. See Tables 9.B and 9.C.
- Step 8. Reconnect the motor to the Drive.
- Step 9. Reattach the Drive's cover.
- Step 10. Reapply input power.

# Spare Allen-Bradley Parts

Table 9.2 - Resistance Checks for Input Diodes

Input Diode No.	Meter Connection		Component is OK if resistance (R) is:	Component is defective if:
	(+)	(-)		
1	*	R/L1	50 < R < 10 Megohm	Continuity (short circuit) or open when the meter is connected with reversed polarity.
2	*	S/L2		
3	*	T/L3		
4	R/L1	**		
5	S/L2	**		
6	T/L3	**		

\*(+)DC bus volts power terminal

\*\* (-) DC bus volts power terminal

Table 9.3 - Resistance Checks for IGBTs

IGBT No.	Meter Connection		Component is OK if resistance (R) is:	Component is defective if:
	(+)	(-)		
1	*	W/T3	50 < R < 10 Megohm	Continuity (short circuit) or open when the meter is connected with reversed polarity.
2	*	V/T2		
3	*	U/T1		
4	W/T3	**		
5	V/T2	**		
6	U/T1	**		

\*(+)DC bus volts power terminal

\*\* (-) DC bus volts power terminal

## Technical Specifications

**Table A.A - Service Conditions**

AC Line Distribution Capacity (Maximum)	Three-phase 575 VAC, with 30,000 amps symmetrical fault current capacity
Control Method	All-digital, pulse-width-modulated (PWM)
Carrier Frequency	4 kHz, 6 kHz, or 8 kHz, software selectable
Displacement Power Factor	0.96
Line Frequency	50/60 Hz ( $\pm 5$ Hz)
Line Voltage Variation	-10% to +10%
Line Dip RideThrough	500 milliseconds
Linearity	0.05 (Speed reference to output frequency)
Long-term Frequency Stability	0.01%
Minimum Frequency Range	0.5 – 30 Hz
Maximum Frequency Range	30 – 240 Hz
Maximum Load	150% for 1 minute (based on Drive nameplate rating)
Motor Lead Lengths	76 meters (250 feet) total (See table 3.7 for more information)
Overcurrent Trip IET	200% rated Drive current

**Table A.B - Dimensions**

Enclosure	Height	Depth	Width	Weight
B	301.7 mm (11.88")	160.1 mm (6.30")	222.3 mm (8.75")	5.4 kg (12 lb)
C	357.8 mm (14.10")	158.2 mm (6.20")	278.1 mm (10.9")	8.1 kg (18 lb)

**Table A.C - Environmental Conditions**

Operating Temperature	0° to +40°C (32° to 104°F) – enclosed Drives 0° to +55°C (32° to 131°F) – open chassis (cover removed)
Storage Temperature	-40° to +65°C (-40° to +149°F)
Humidity	5 to 95% (non-condensing)
Altitude	Do not install the Drive above 1000 meters (3300 feet) without derating output power. For every 91.4 meters (300 feet) above 1000 meters (3300 feet) up to 3033 meters (10,000 feet), derate the output current by 1%. Above 3033 meters (10,000 feet), contact your local Allen – Bradley sales office for assistance.

# Spare Allen-Bradley Parts

**(Continued)****Table A.D - Drive Inputs**

Analog Speed Reference	0 to 10 VDC or 0 to 20 mA
Start	Edge-sensitive signal that must see an open-to-closed contact transition. This transition may be a momentary or fixed closure.
Stop	An open contact that must be closed when the Drive is running. The Drive will remain off as long as the contact is open.
IET Reset	Edge-sensitive signal that must see an open-to-closed contact transition. This transition may be a momentary or fixed closure.
Forward/Reverse	An open contact to assert the forward direction and a closed contact to assert the reverse direction.
Function Loss	An open contact that must be closed when the Drive is running. When the contact is open, the Drive turns off. The Drive will remain off as long as the contact is open.

**Table A.E - Drive Outputs**

Analog Output (0-10 VDC scaled signal)	<p>The scaled signal is selected through parameter F-29 and can be one of the following:</p> <ul style="list-style-type: none"> <li>● Output Voltage: 0 to 632 VAC</li> <li>● % Load (Amps): 0 to 200% (Percentage of output amps based on the Drive nameplate.)</li> <li>● RPM/Engineering Unit: Minimum to maximum RPM or minimum to maximum of any engineering unit (See parameter F-08)</li> <li>● % Selected Speed Reference: 0 to 100% (Percentage of the selected reference signal range.)</li> </ul>
Snubber Resistor Braking	Snubber resistor control signal used by an optional snubber resistor.
Output Status Relay	115 VAC/24 VDC, 0.5 Amp, relay output (One Form A and one Form B contact wired with a single common.)



## User Settings Record

Parameter No.	Parameter Name	Range	Step Size	Default Setting	Setting	Date
F-00	Control Source Select	0, 1, 2, 3	N/A	0		
F-01	Accel Time (seconds)	0.5 - 90.0	0.10	5.0		
F-02	Decel Time (seconds)	0.5 - 90.0	0.10	5.0		
F-03	Minimum Speed (Hz)	0.5 - 30.0	0.10/0.25	5.0		
F-04	Maximum Speed (Hz)	30.0 - 240.0	0.10/0.25	60.0		
F-05	Current Limit (%)	10 - 150	1.0	150		
F-06	Manual Torque Boost (%)	2 - 10	1.0	2		
F-07	V/Hz Base Speed (Hz)	3 - 240	1.0	60		
F-08	RPM at Base Speed	10 - 9999	1.0	1750		
F-09	Configurable Output Relay Select	0, 1, 2	N/A	0		
F-10	Carrier Frequency (kHz)	4, 6, 8	N/A	4		
F-11	Remote Reference Gain (%)	60 - 100	0.10	100		
F-12	Remote Reference Offset (%)	0 - 40	0.10	0		
F-13	Percent Selected Speed Reference Display Enable	ON, OFF	N/A	OFF		
F-14	Electronic Thermal Overload (%)	20 - 100	1.0	100		
F-15	Electronic Thermal Overload Enable	ON, OFF	N/A	ON		
F-16	Coast Stop Enable	ON, OFF	N/A	ON		
F-17	Reverse Disable	ON, OFF	N/A	OFF		
F-18	RPM Setpoint Enable	ON, OFF	N/A	OFF		
F-19	Power-Up Start Enable	ON, OFF	N/A	OFF		
F-20	Password Lockout Enable	ON, OFF	N/A	OFF		
F-21	Avoidance Frequency (Hz)	Min speed - Max speed	0.10	5		
F-22	Avoidance Bandwidth (Hz)	0.0 - 30.0	0.10	0		
F-23	Multi-Speed Preset 1 (Hz)	Min speed - Max speed	0.10	20		
F-24	Multi-Speed Preset 2 (Hz)	Min speed - Max speed	0.10	20		
F-25	Multi-Speed Preset 3 (Hz)	Min speed - Max speed	0.10	20		
F-26	Auto-Restart Number of Attempts	0 - 10 0 = disabled	N/A	0		
F-27	Auto-Restart Retry Wait Time (seconds)	1 - 30	1.0	1		
F-28	Drive Voltage Selection	This parameter is set at the factory. Do not change the setting.				

# Spare Allen-Bradley Parts

<b>Parameter No.</b>	<b>Parameter Name</b>	<b>Range</b>	<b>Step Size</b>	<b>Default Setting</b>	<b>Setting</b>	<b>Date</b>
F-29	Analog Output Select	SPd LOAd UOL rEF	N/A	SPd		
F-49	Version Information	x.xx	N/A	Read Only		

## Parameter Listing (Alphabetical)

Acceleration Time	F-01
Analog Output Select	F-29
Auto-Restart Number of Attempts	F-26
Auto-Restart Retry Wait Time	F-27
Avoidance Bandwidth	F-22
Avoidance Frequency	F-21
Carrier Frequency	F-10
Coast Stop Enable	F-16
Configurable Output Relay Select	F-09
Control Source Select	F-00
Current Limit	F-05
Deceleration Rate	F-02
Drive Voltage Selection	F-28
Electronic Thermal Overload	F-14
Electronic Thermal Overload Enable	F-15
Manual Torque Boost	F-06
Maximum Speed	F-04
Minimum Speed	F-03
Multi-Speed Preset 1	F-23
Multi-Speed Preset 2	F-24
Multi-Speed Preset 3	F-25
Password Lockout Enable	F-20
Percent Selected Speed Reference Display Enable	F-13
Power-Up Start Enable	F-19
Remote Reference Gain	F-11
Remote Reference Offset	F-12
Reverse Disable	F-17
RPM at Base Speed	F-08
RPM Setpoint Enable	F-18
V/Hz (Base Speed)	F-07
Version Information	F-49

# Spare Allen-Bradley Parts

**This Page Intentionally Blank**

## Replacement Parts

### Introduction

Table D.A lists the replacement parts available from Allen–Bradley for this model 1302 Drive.

Table D.A – Replacement Parts List for 1302 Drives

Description	Part Number	Quantity per Horsepower					
		1 HP	2 HP	3 HP	5 HP	7.5 HP	10 HP
Fan Assembly	615161-S	–	–	1	1	2	2
NEMA 4X Cover/Gasket	807309-1A	1	1	1	1	–	–
	807310-1A	–	–	–	–	1	1
NEMA 1 Cover	807309-2A	1	1	1	1	–	–
	807310-2A	–	–	–	–	1	1
Membrane Switch (Keypad)/Bracket	709507-1R	1	1	1	1	–	–
	709511-1R	–	–	–	–	1	1
Regulator PCB	56953-3xx	1	1	1	1	–	–
	56954-3xx	–	–	–	–	1	1
Capacitor PCB	56922-055	–	–	1	1	–	–
	56939-105	–	–	–	–	1	1
Fan Assembly (Internal)	615159-1R	–	–	–	1	1	1

# Spare Allen-Bradley Parts

**This Page Intentionally Blank**

## A

Acceleration Time (F01), 8–5

AC input

- diodes checking, 9–8
- fuses, 3–8
- line branch circuit fuses, 3–7
- ratings, 2–3
- wire sizes, 3–5
- wiring, 5–1

AC line distribution capacity, A–1

AC output wiring, 3–5 & 5–10

Air flow, 3–4

Altitude requirements, A–1

Analog input jumper (J6), 5–3

Analog Output Select (F29), 5–4

Analog speed reference wiring, 5–3

Area required, 3–2

Auto Restart Number of Attempts (F26), 8–18

Auto Restart Retry Wait Time (F27), 8–19

Avoidance Bandwidth (F22), 8–16

Avoidance Frequency (F21), 8–15

## B

Board

- Capacitor, 2–8 & 2–9
- Power, 2–8 & 2–9
- Regulator, 2–5 & 4–6

Braking, snubber resistor wiring, 5–8

## C

Carrier Frequency (F10), 8–9

Coast Stop (F16), 8–13

Conduit size, 4–2 & 4–3

Configurable Output Relay Select (F09), 8–9

Control Source Select (F00), 8–4

Control Terminal Strip, 8–4

Control wiring, 2–8 & 2–9

Current Limit (F05), 8–6

## D

DC bus

- terminals, 9–2
- verifying capacitor voltage, 9–1

Deceleration Rate (F02), 8–5

Digital input wiring, 5–4

- Forward/reverse, 5–7
- Function loss, 5–7
- IET reset, 5–7
- Multi speed reset, 5–6
- Start/stop, 5–5

Dimensions, 3–3

Display

- description, 7–1
- scaling, see RPM at Base Speed (F08), 8–8

Drive faults, see Faults, 9–2

Drive Voltage Selection (F28), 8–19

## E

Electronic Thermal Overload (F14), 8–12

Electronic Thermal Overload Enable (F15), 8–12

Emergency stop, 3–8

Enclosures, NEMA, 2–7

Environmental conditions, 2–7 & A–1

Error log, 9–5

## F

Fault Codes, 9–2

Faults

- drive reaction to, 9–2
- possible causes and corrective actions, 9–2
- resetting, 9–2

Forward, digital input, 5–4

Frequency, carrier, 2–2

Function loss, digital input, 5–7

**G**

Grounding, 5-10

**H**

Humidity, A-1

**I**

IET reset, digital input, 5-7

IGBT power devices  
 checking, 9-8  
 Input, AC, 2-2

**J**

Jumper (J6)  
 location of, 4-6

**L**

Lead lengths, motor, 3-6  
 LED descriptions, 7-3  
 Line frequency, A-1  
 Line noise, avoiding, 4-5

**M**

Manual Torque Boost (F06), 8-7  
 Maximum Speed (F04), 8-6  
 Mechanical motor overload protection, 4-5  
 Membrane switch/bracket assembly, 2-8 & 2-9  
 Minimum Speed (F03), 8-5  
 Model numbers, 2-6  
 Monitor mode, 7-6  
 Motor  
 lead lengths, 3-6  
 multiple motor applications, 3-6 & 3-9  
 overload protection, mechanical, 4-5  
 single motor applications, 3-6 & 3-9  
 Mounting dimensions, 3-3  
 Multi-Speed Presets 1,2,3 (F-23, F-24, F-25), 8-17  
 Multi-Speed presets, digital inputs, 5-6

**N**

NEMA enclosures, 2-7

**O**

Option kits, 2-7  
 Output  
 current, 2-8  
 power wiring, 5-10  
 status relay wiring, 5-9

**P**

Parameters  
 displaying or changing values, 8-1  
 factory settings and defaults, B-1  
 listed alphabetically, C-1  
 menu structure, 7-5  
 password protection, 8-2  
 record of user settings, D-1  
 Parts, replacement, D-1  
 Password protection, 8-2  
 Percent Selected Speed Reference Display Enable (F-13), 8-11  
 Planning  
 drive clearance 3 - 2 & 3 - 4  
 location, 3-2 & 3-4  
 Power  
 loss ratings, 3-2, 3-4  
 wire sizes, 3-2 & 3-4  
 Power Module  
 checking circuitry with power off, 9-7  
 Power Up Start Enable (F19), 8-14  
 Program mode, 8-1

**R**

Ratings  
 AC input, 2-3  
 NEMA, 2-7  
 power, 2-1  
 power loss, 2-1  
 Regulator Board, 2-5  
 Remote Reference Gain (F-11), 8-10  
 Remote Reference Offset (F-12),  
 Replacement parts, D-1  
 Reset, digital input, 5-5



Resistor, snubber braking, 2-7  
Reverse, digital input, 5-7  
Reverse Disable (F-17), 8-13  
Routing, wire, 4-1  
RPM at Base Speed (F-08), 8-8  
RPM at Setpoint Enable (F-18), 8-14

## S

Scaling the RPM display and  
reference, 7-7  
Signal wiring, 3-5 & 5-3  
Site requirements, 3-2  
Snubber resistor braking, 2-7  
Specifications  
    conduit opening sizes, 4-2 & 4-3  
    environmental, A-1  
    dimensions, A-1  
    drive inputs, A-2  
    drive outputs, A-2  
    service conditions, A-1  
    terminal torque ratings, 3-5  
    wire sizes, 3-5  
Start, digital input, 5-5  
Stop, digital input, 5-5  
Stopping the drive, 5-8

## T

Terminal Strip  
    torque specifications, 3-5

    wire sizes, 3-5  
    wiring, 3-5  
Testing, IGBT, 9-8  
Torque specifications, 3-5  
Transformer, isolation, 4-4

## V

Ventilation, see Air Flow, 3-4  
Version Information (F-49), 8-19  
V/Hz (Base Speed) (F-07), 8-7

## W

Weights, A-1  
Wire routing, 4-2 & 4-3

**This Page Intentionally Blank**

This Page Intentionally Blank

Spare Allen-Bradley Parts

**This Page Intentionally Blank**



Allen-Bradley, a Rockwell Automation Business, has been helping its customers improve productivity and quality for more than 90 years. We design, manufacture and support a broad range of automation products worldwide. They include logic processors, power and motion control devices, operator interfaces, sensors and a variety of software. Rockwell is one of the world's leading technology companies.

### Worldwide representation.



Argentina • Australia • Austria • Bahrain • Belgium • Brazil • Bulgaria • Canada • Chile • China, PRC • Colombia • Costa Rica • Croatia • Cyprus • Czech Republic • Denmark • Ecuador • Egypt • El Salvador • Finland • France • Germany • Greece • Guatemala • Honduras • Hong Kong • Hungary • Iceland • India • Indonesia • Ireland • Israel • Italy • Jamaica • Japan • Jordan • Korea • Kuwait • Lebanon • Malaysia • Mexico • Netherlands • New Zealand • Norway • Pakistan • Peru • Philippines • Poland • Portugal • Puerto Rico • Qatar • Romania • Russia-CIS • Saudi Arabia • Singapore • Slovakia • Slovenia • South Africa, Republic • Spain • Sweden • Switzerland • Taiwan • Thailand • Turkey • United Arab Emirates • United Kingdom • United States • Uruguay • Venezuela • Yugoslavia

Allen-Bradley Headquarters, 1201 South Second Street, Milwaukee, WI 53204 USA, Tel: (1) 414 382-2000 Fax: (1) 414 382-4444

# Spare Allen-Bradley Parts