



Allen-Bradley 1397 AC Tachometer Interface Card

Cat. No. 1397-AC

Contents

Topic	Page
What This Option Provides	1
Where This Option Is Used	1
What These Instructions Contain	1
Specifications	1
How to Select an AC Tachometer	2
Installation	3
Tachometer Wiring	6
Setup	6

What this Option Provides

The AC Tachometer Interface Card is designed for use with the following Reliance tachometers RE-045F, RE-045R or RE-050. The card provides feedback signals for non-regenerative 1397 drives and cannot be used in conjunction with the Pulse Encoder Interface Card.

Where this Option is Used

This option may only be used with 1397 Non-Regenerative Drives.

What These Instructions Contain

These instructions contain the necessary information to install & configure a 1397 AC Tachometer Interface Card. For additional information on signal requirements, wire or cable requirements and parameter programming, refer to the 1397 User Manual, publication 1397-5.0 and the AC tachometer instructions.

Specifications

Item	Specification
Maximum Cable Length:	Refer to the AC Tachometer Instructions
Maximum Power Dissipation:	4W
Maximum Input Voltage from Tachometer:	275V AC rms
Input Impedance:	20k Ohms

How to Select an AC Tachometer

Before installing the AC Tachometer Interface Card, the tachometer’s maximum AC output voltage and the card’s maximum DC output voltage must be calculated. Performing these calculations will assure:

- That the correct AC tachometer is selected.
- That the correct drive Regulator Board settings are made.
- That the Tachometer Interface Card is wired correctly.

Step 1 – Determine the Tachometer’s Maximum AC Output Voltage

As listed in the card’s specifications; at the application’s maximum motor RPM, voltage at the input of the AC Tachometer Interface Card must not exceed 275V AC rms.

$VAC_{in} = \frac{[Tach_{volt} \times N_{max}]}{1000}$	<p>where:</p> <p>VAC_{in} = The Interface Card’s Maximum AC Input Voltage.</p> <p>$Tach_{volt}$ = P.047 [Anlg Tach V/1000]. The Tachometer’s Nameplate Volts/1000 RPM Rating.</p> <p>N_{max} = Required Maximum Motor RPM for the Application.</p>
--	---

Step 2 – Determine the Card’s Maximum DC Output Voltage

$VDC_{out} = VAC_{in} \times 0.9$	<p>where:</p> <p>VDC_{out} = The Interface Card’s Maximum DC Output Voltage.</p> <p>VAC_{in} = The Interface Card’s Maximum AC Input Voltage</p>
-----------------------------------	--

Example

An RE-045F Reliance Tachometer is used in an application that has a required maximum motor speed of 2500 RPM. An RE-045F Tachometer has a nameplate output voltage of 45V AC (+10V AC/–5V AC) / 1000.

Determine the Card’s Maximum AC Input Voltage

$$VAC_{in} = \frac{[(45 + 10) \times 2500]}{1000}$$

$$VAC_{in} = 137.5V \text{ AC}$$

Determine the Card’s Maximum DC Output Voltage

$$VDC_{out} = 137.5V \text{ AC} \times 0.9$$

$$VDC_{out} = 123.75V \text{ DC}$$

Installation



ATTENTION: This board contains ESD (Electrostatic Discharge) sensitive parts and assemblies. Static control precautions are required when installing, testing, servicing or repairing this assembly. Component damage may result if ESD control precautions are not followed. If you are not familiar with static control procedures, reference publication 8000-4.5.2, “Guarding against Electrostatic Damage” or any other applicable ESD protection handbook.



ATTENTION: Electric Shock can cause injury or death. Remove all power before working on this product. The drive is at line voltage when connected to incoming AC power. Before proceeding with any installation or troubleshooting activity, disconnect, lock out, and tag all incoming power to the drive. Verify with a voltmeter that no voltage exists at terminals L1, L2 and L3 on the drive input power terminal block.

1. Remove and lock-out all incoming power to the drive. Loosen the (2) captive retaining screws and remove the drive cover.

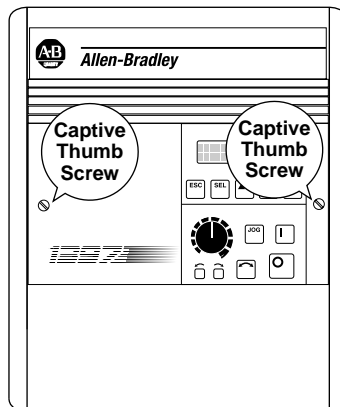

2. Loosen the captive carrier retaining screw and swing the carrier door open.

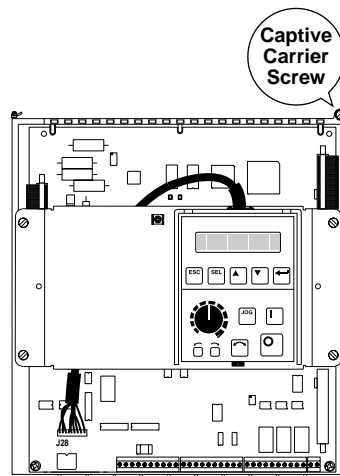

3. To remove the carrier shield, remove the (4) retaining screws and unplug the ground wire at the Power Supply Board.

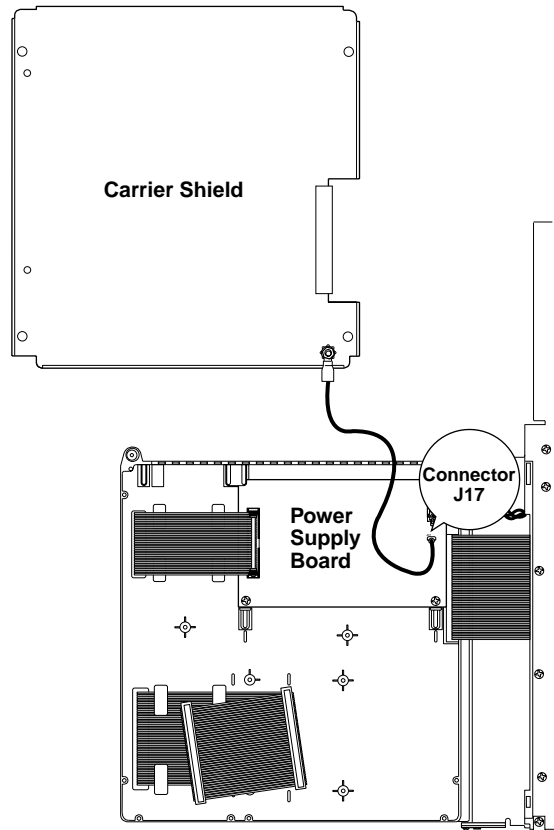
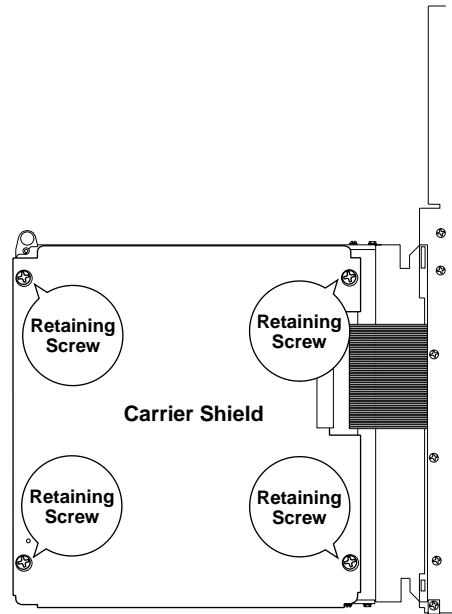

If an I/O Expansion Card is also required, complete both Steps 4 and 5.

4. Install the AC Tachometer Interface Card in the drive carrier using the (2) pan head screws provided.

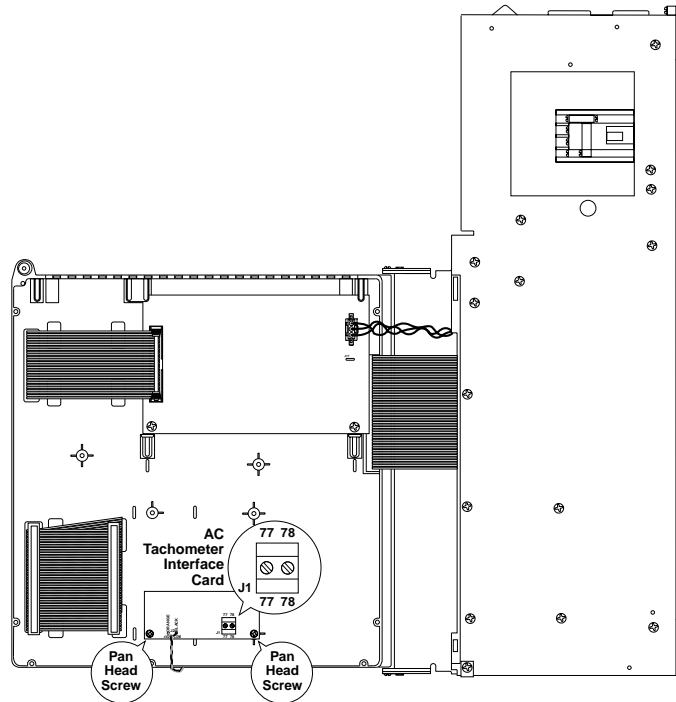

5. If an I/O Expansion Card is used, the AC Tachometer Interface Card is mounted piggy back on the I/O Expansion Board and connected using the hardware included with the AC Tachometer Interface Kit.

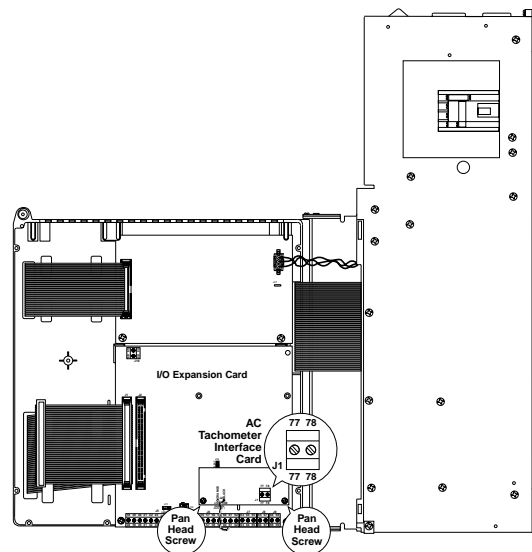

6. Connect the AC output tachometer leads to AC terminals 77 & 78 – Polarity is unimportant.

7. Route the card's orange and black twisted cable underneath the drive carrier to Regulator Board Terminal Block J3 as shown. Make connections to J3 per the table on [page 7](#).

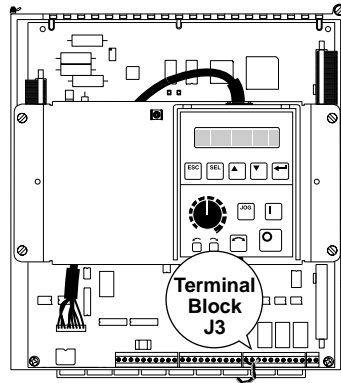

Tachometer Wiring

Refer to the Cable & Wire Recommendations in the 1397 User Manual as well as any tachometer wiring instructions included with the Reliance tachometer.



ATTENTION: Applying the incorrect polarity to the AC Tachometer Interface Card's orange & black J2 output wires can cause an overspeed condition. Connect these wires accurately as described in the Setup Section that follows. Failure to observe this precaution could result in bodily injury and/or equipment damage.

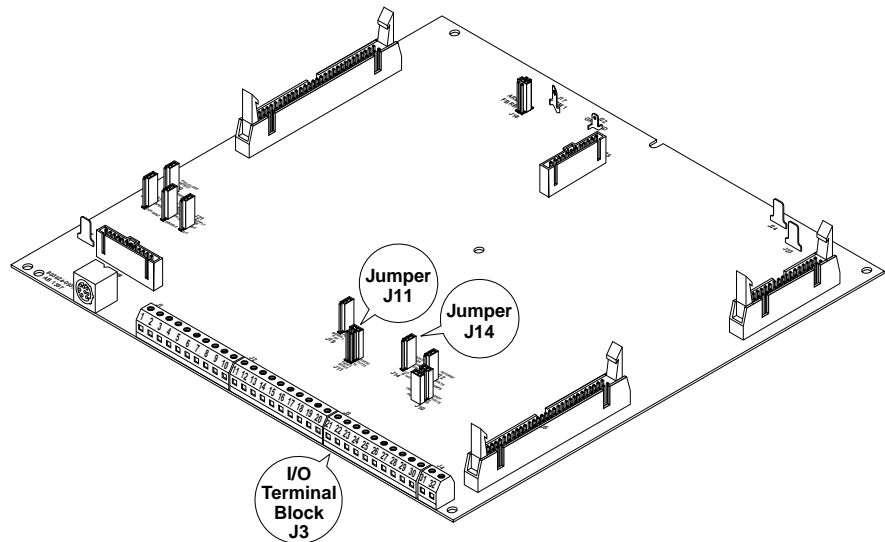

Setup

(4) parameters as well as Jumpers J11 & J14 on the drive's Regulator Board are used to configure the AC Tachometer Interface Card.

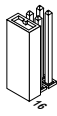
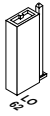
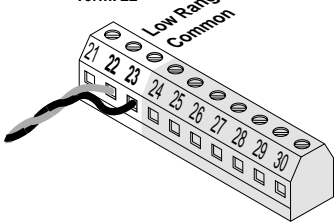
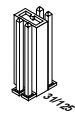
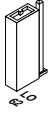
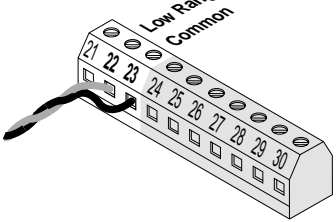
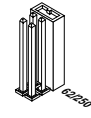

Wire & Jumper Settings

Wire & jumper settings are made to the drive's Regulator Board based on the DC output voltage calculated in Step 2 on page [2](#).

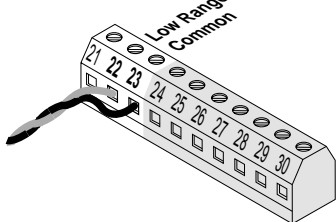
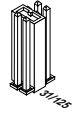
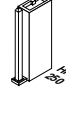
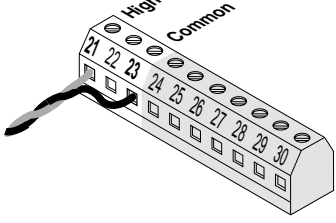
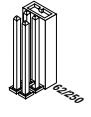
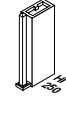
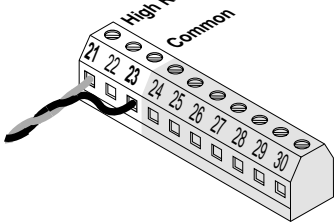
If the Card's Calculated DC Output Voltage Is —	Set Jumper J11 to —	Set Jumper J14 to —	Connect the Card's Twisted Cable to TB J3 Connect the Black Wire to Term 23 Connect the Orange Wire to —
$\leq 16\text{VDC}$	16 	LO 62 	Term. 22 
17-31V DC	31/125 	LO 62 	Term. 22 
32-62V DC	62/250 	LO 62 	Term. 22 
63-125V DC	31/125 	HI 250 	Term. 21 
126-250V DC	62/250 	HI 250 	Term. 21 

AC Tachometer Parameter Settings

To finish configuring the card for the selected AC Tachometer, up to (4) parameters must be set depending upon the application. When setting AC tachometer parameters, P.194 [Anlg Tach Fdbk] may be used to “zero” the tachometer as indicated.



ATTENTION: The incorrect setting of parameters P.039, P.047, P.057 and P.058 can cause an overspeed condition. Both parameters must be set by a qualified person who understands the significance of setting them. Set the value of these parameters accurately per your application requirements. Failure to observe this precaution could result in bodily injury.

P.039 – Set Feedback Type to AC Tach

This parameter is set to match the type of drive feedback signal used.
Default Value = Arm Volt

P.047 – Set Anlg Tach V/1000 to the AC Tachometer’s Nameplate Voltage/1000. The Same Value Set in Step 1 on Page 2

This parameter along with P.041 is used by the drive to calculate the value of the tachometer’s range.
Default Value = 18.0 volts/1000

P.057 – Reset Anlg Tach Gain Only if Required

This is an advanced setup parameter used to scale the AC tachometer feedback signal only after all AC tachometer installation is complete and then only if required. Refer to the Start-Up and Adjustment procedures in the 1397 User Manual as well as any tachometer instructions included with the Reliance tachometer kit for additional information.
Default Value = 0

P.058 – Reset Anlg Tach Zero Only if Required

This is an advanced setup parameter used to remove any hardware induced offset from the AC tachometer feedback loop signal. If the value of P.194 [Anlg Tach Fdbk] is some value other than zero, P.194 is “zeroed” using a corrective + or – P.058 value.
Default Value = 1.000

www.rockwellautomation.com

Power, Control and Information Solutions Headquarters

Americas: Rockwell Automation, 1201 South Second Street, Milwaukee, WI 53204-2496 USA, Tel: (1) 414.382.2000, Fax: (1) 414.382.4444

Europe/Middle East/Africa: Rockwell Automation, Vorstaan/Boulevard du Souverain 36, 1170 Brussels, Belgium, Tel: (32) 2 663 0600, Fax: (32) 2 663 0640

Asia Pacific: Rockwell Automation, Level 14, Core F, Cyberport 3, 100 Cyberport Road, Hong Kong, Tel: (852) 2887 4788, Fax: (852) 2508 1846