



Allen-Bradley

Y-Series

Brushless Servo Motor Manual

Rockwell
Automation

Bringing Together Leading Brands in Industrial Automation

Use of Motors

Servo motors are intended to drive machinery. As such, they must be part of a controlled system that includes a transistorized electronic amplifier. They are not intended for direct connection to the power supply or for use with thyristor drives. Instructions in the amplifier and control system manuals must be observed; this document does not replace those instructions.

Unless specified otherwise, servo motors are intended for use in a normal industrial environment without exposure to excessive or corrosive moisture or abnormal ambient temperatures. The exact operating conditions may be established by referring to the data for the motor. The mating of motors to machinery is a skilled operation; disassembly or repair must not be attempted. In the event that a motor fails to operate correctly, contact the place of purchase for return instructions.

Safety Notes

There are some possible hazards associated with the use of motors. The following precautions should be observed. Specific Warnings and Cautions are listed inside the back cover.

Installation and Maintenance: Installation and maintenance or replacement must be carried out by suitably qualified service personnel, paying particular attention to possible electrical and mechanical hazards.

Weight: Large motors are generally heavy, and the center of gravity may be offset. When handling, take appropriate precautions and use suitable lifting equipment. Beware of sharp edges; use protective gloves when handling such assemblies.

Flying leads: Ensure that flying or loose leads are suitably restrained, to prevent snagging or entanglement, before carrying motors with such leads.

Generation: If the motor is driven mechanically, it may generate hazardous voltages at its power input terminals. The power connector must be suitably guarded to prevent a possible shock hazard.

Loose motors: When running an unmounted motor, ensure that the rotating shaft is adequately guarded and the motor is physically restrained to prevent it from moving. Remove the key which otherwise could fly out when the motor is running.

Damaged cables: Damage to cables or connectors may cause an electrical hazard. Ensure there is no damage before energizing the system.

Supply: Servo motors must not be directly connected to a power supply; they require an electronic drive system. Consult the instructions for the drive system before energizing or using the motor.

Brakes: The brakes that are included on motors are holding brakes only and are not to be used as a mechanical restraining device for safety purposes.

Safety requirements: The safe incorporation of this product into a machine system is the responsibility of the machine designer, who should comply with the local safety requirements at the place where the machine is to be used. In Europe this is likely to be the Machinery Directive.

Mechanical connection: Motors must be connected to the machine with a torsionally rigid coupler or a reinforced timing belt. Couplers which are not rigid will cause difficulty in achieving an acceptable response from the control system. Couplings and pulleys must be tight as the high dynamic performance of a servo motor can easily cause couplings to slip, and thereby damage the shaft and cause instability. Care must be taken in aligning couplings and tightening belts so that the motor is not subjected to significant bearing loads, or premature bearing wear will occur. Once connected to a load, tuning will be affected. A system tuned without a load will probably require retuning once a load is applied.

Connectors: Motor power connectors are for assembly purposes only. They should not be connected or disconnected while power is applied.

Motor Data

MOTOR MODEL		Y-1002-1	Y-1002-2	Y-1003-1	Y-1003-2	Y-2006-1	Y-2006-2
		MECHANICAL DATA (1)					
Rotor Moment of Inertia	kg-m ²	0.0000031	0.0000031	0.0000051	0.0000051	0.000015	0.000015
	lb-in-s ²	0.000027	0.000027	0.000045	0.000045	0.00013	0.00013
Brake Motors	kg-m ²	0.0000039	0.0000039	0.0000059	0.0000059	0.000020	0.000020
Rotor Moment of Inertia	lb-in-s ²	0.000034	0.000034	0.000052	0.000052	0.00018	0.00018
Motor Weight: Net	kg/lb	0.5/1.1	0.5/1.1	0.6/1.3	0.6/1.3	1.3/2.9	1.3/2.9
	Shipping	kg/lb	1.3/2.9	1.3/2.9	1.4/3.1	1.4/3.1	2.1/4.6
Brake Motor Weight: Net	kg/lb	0.8/1.8	0.8/1.8	0.9/2.0	0.9/2.0	1.8/4.0	1.8/4.0
	Shipping	kg/lb	1.4/3.1	1.4/3.1	1.5/3.3	1.5/3.3	2.5/5.5
Damping	Nm/krpm	0.002	0.002	0.003	0.003	0.009	0.009
	lb-in/krpm	0.022	0.022	0.03	0.03	0.08	0.08
Friction Torque	Nm	-	-	0.007	0.007	0.022	0.022
	lb-in	-	-	0.06	0.06	0.20	0.20
Max. Operating Speed	rpm	4500	4500	4500	4500	4500	4500
		WINDING DATA (1)					
Poles		8	8	8	8	8	8
Sine Wave K _T	Nm/A	0.082	0.16	0.11	0.20	0.107	0.22
	lb-in/A	0.73	1.46	1.02	1.8	0.95	1.97
Square Wave K _T	Nm/A	0.090	0.18	0.12	0.22	0.117	0.24
	lb-in/A	0.80	1.6	1.1	2.0	1.04	2.16
Torque Constant (3)							
K _E Voltage Constant (4)	V/krpm	10	20	14	25	13	27
Winding Resistance	Ohms ±10%	4.6	18.8	3.2	8.9	0.79	3.2
Phase to Phase at 25°C							
Winding Inductance	mH	5.5	22.3	3.8	11.5	2.7	12
Phase to Phase							
Thermal Resistance	°C/Watt	2.3	2.3	2.2	2.2	1.3	1.3
Dielectric Rating		Power Leads (R, S, T) to Ground: 1500 VACrms 50/60 Hz for 1 minute.					

MOTOR MODEL		Y-2012-1	Y-2012-2	Y-3023-2
		MECHANICAL DATA (1)		
Rotor Moment of Inertia	kg-m ²	0.000026	0.000026	0.000064
	lb-in-s ²	0.00023	0.00023	0.00056
Rotor Moment of Inertia	kg-m ²	0.000032	0.000032	0.000069
Brake Motors	lb-in-s ²	0.00028	0.00028	0.00061
Motor Weight: Net	kg/lb	1.9/4.2	1.9/4.2	3.5/7.7
	Shipping	kg/lb	2.7/6.0	2.7/6.0
Brake Motor Weight: Net	kg/lb	2.4/5.3	2.4/5.3	4.4/9.7
	Shipping	kg/lb	3.1/6.8	3.1/6.8
Damping	Nm/krpm	0.01	0.01	0.021
	lb-in/krpm	0.10	0.10	0.19
Friction Torque	Nm	0.03	0.03	0.072
	lb-in	0.29	0.29	0.64
Max. Operating Speed	rpm	4500	4500	4500
		WINDING DATA (1)		
Poles		8	8	8
Sine Wave K _T	Nm/A	0.24	0.37	0.33
Torque Constant (2)	lb-in/A	2.1	3.3	2.9
Square Wave K _T	Nm/A	0.26	0.40	0.36
	lb-in/A	2.3	3.6	3.2
Torque Constant (3)				
K _E Voltage Constant (4)	V/krpm	29	45	40
Winding Resistance	Ohms ±10%	1.32	2.9	0.78
Phase to Phase at 25°C				
Winding Inductance	mH	5.1	12.4	6
Phase to Phase				
Thermal Resistance	°C/Watt	1.3	1.3	0.85
Dielectric Rating		Power Leads (R, S, T) to Ground: 1500 VACrms 50/60 Hz for 1 minute.		

(1) Specifications are at 25°C unless otherwise noted.

(2) Peak value of per phase sine wave Amperes

(3) Peak value of per phase square wave Amperes

(4) Peak value of sinusoidal phase to phase Volts

STORAGE AND OPERATING CONDITIONS

Ambient Temperature: Operating	0 to 40°C (32 - 104°F)	Relative Humidity:	20% to 90%
Storage	-20 to 65°C (-4 - 149°F)		non-condensing

Dimensional Data

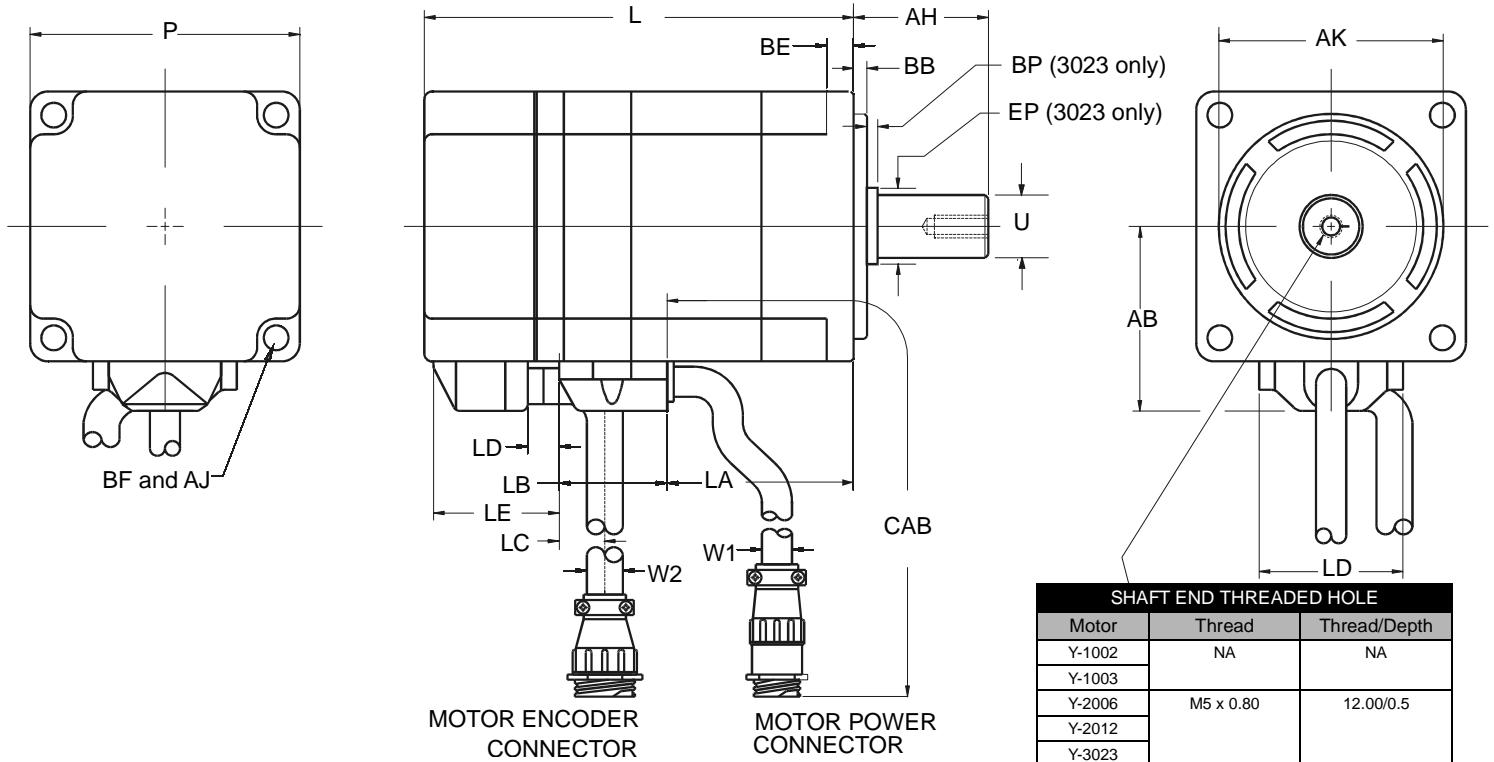

SHaft END THREADED HOLE		
Motor	Thread	Thread/Depth
Y-1002	NA	NA
Y-1003		
Y-2006	M5 x 0.80	12.00/0.5
Y-2012		
Y-3023		

NOTE: Motors are manufactured to millimeter dimensions.
Inch dimensions are approximate conversions.

Motor Dimensions

MOTOR DIMENSIONS																	
Motor Model	AB	AH	AJ	AK	BB	BE	BF	BP	EP	L	L Brake	P	U	CAB	TOLERANCES		
	mm/in	mm/in	mm/in	mm/in	mm/in	mm/in	mm/in	mm/in	mm/in	mm/in	mm/in	mm/in	mm/in	mm/in	mm	inches	
Y-1002	30/1.2	25/1.0 (1)	46/1.8	30/1.2 (2)	2.5/0.10	5/0.20	4.5/0.18	-	-	70.0/2.8 (3)	108.5/4.27 (3)	40/1.6	8/0.3 (4)	1000/39.4 (8)	1	± 0.800	0.0314
Y-1003	41/1.6	30/1.2 (1)	70/2.8	50/2.0 (5)	3.0/0.12	6/0.24	5.5/0.22			88.0/3.5 (3)	126.5/4.98 (3)				60/2.4	14/0.5 (7)	2
Y-2006										95.5/3.8 (3)	133.5/5.26 (3)	3	± 1				0.04
Y-2012										123.5/4.9 (3)	161.5/6.36 (3)	4	0.009		0.0003		
Y-3023	52/2.0	40/1.6 (1)	90/3.5	70/2.8 (6)	3.0/0.12	8.0/0.3	6.6/0.26	2.0/0.08	19.5/0.77	140.0/5.5 (3)	180.5/7.11 (3)	80/3.1	16/0.6 (7)	5	0.025	0.0009	
															6	0.030	0.0011
															7	-0.011	0.0004
															8	±100	4

SUPPLEMENTAL MOTOR DIMENSIONS					
Length, from motor faceplate to center of connectors					
Dimension	Y-1002	Y-1003	Y-2006	Y-2012	Y-3023
LA	23.5/0.90	41.5/1.60		69.5/2.7	80.5/3.2
LB	21.5/0.84		24.0/0.95		30.0/1.2
LC (9)	17.5/0.70		-		
LC (Brake) (9)	56/2.2				
LD	-		7.0/0.28		
LD (Brake)	-		45/1.77		
LE	-		28.0/1.10		
LE (Brake)	-		66/2.60		
(9) Measurement is to center of perpendicular motor encoder cable. Motor encoder cable exits perpendicular to motor frame on Y-1002 and Y-1003 motors (not as shown).					

CABLE DIAMETERS		
Motor	W1 - Power/Brake	W2 - Encoder
Y-1002	6.0/0.24	8.0/0.31
Y-1003		
Y-2006	6.7/0.26	
Y-2012		
Y-3023		
Minimum 90° cable bend allowance is 15mm.		

Connector Data

All Y-Series Motors - Encoder Connector		
Pin	Signal	Wire color
1 to 8	-	-
9	A+	PURPLE
10	A-	GREEN
11	B+	BLUE
12	B-	BROWN
13	I+	WHITE
14	I-	YELLOW
15	HALL A+	GREEN/BLACK
16	HALL A-	PURPLE/BLACK
17	HALL B+	BLUE/BLACK
18	HALL B-	BROWN/BLACK
19	HALL C+	RED/BLACK
20	HALL C-	YELLOW/BLACK
21	-	-
22	+5 VDC	RED
23	COM	BLACK (1)
24	SHIELD	BLACK (2)
25	-	-
26	-	-
27	-	-
28	-	-

(1) COM (+5VDC) is not connected to motor gnd.

(2) SHIELD is connected to motor case ground.

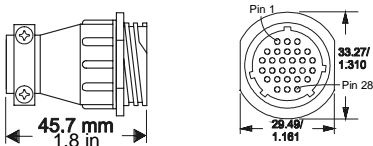

All Y-Series Motors - Power Connector		
Pin	Signal	Wire color
1	PHASE R	RED
2	PHASE S	BLACK
3	PHASE T	WHITE
4	-	-
5	GROUND	GREEN/YELLOW
6	-	-
7	BRAKE + (option)	YELLOW
8	-	-
9	BRAKE - (option)	YELLOW

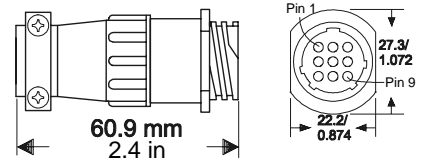

Flying Lead Connector Types		
Motor	Encoder	Power
Y-1002 and Y-1003	Housing: AMP 206152-1 Pin Insert: AMP 3-66507-0	Housing AMP206705-2 Pin Insert: AMP 66102-8
Y-2006 Y-2012 and Y-3023	Housing: AMP 206152-1 Pin Insert: AMP 3-66507-0	Housing AMP206705-2 Pin Insert: AMP 66098-8

NOTE: Connectors are manufactured to inch dimensions. Millimeter dimensions are approximate conversions.

Wire and Contact Sizing Recommendations

The following connector contact sizes and wiring gages are recommended for cabling to a motor.

ENCODER CONNECTOR	
Contact mm ² (AWG)	Wire mm ² (AWG)
0.25 - 0.50 (24 - 20) for all Y-Series	0.34 (22)

- Sizes are recommended minimum values.
- Wiring should be twisted.
- Local regulations should always be observed.

POWER/BRAKE CONNECTOR		
Motor	Contact mm ² (AWG)	Wire mm ² (AWG)
Y-1002 Y-1003	0.75 - 2.5 (18 - 14)	0.75 (18)
Y-2006 Y-2012 Y-3023		1.5 (16)

- Sizes are recommended minimum values.
- Wiring should be twisted.
- Local regulations should always be observed.

Factory manufactured power cables and encoder cables are available in standard cable lengths of 3, 7.6, 15 and 23 meters (10, 25, 50 and 75 feet).

Mating Connector Kit

CONNECTOR KIT			
Item		Part Number	
Encoder and Power Connector Kit		9106-0066	
Kit includes connector housing, pins and backshell with clamp to mate with Y-Series motor connectors.			
Connector	Housing	Socket (Qty Pins included)	Backshell
Encoder	AMP 205839-3	AMP 6-66504-0 (18)	AMP206070-1
Power	AMP 206708-1	AMP 66360-3 (8)	AMP207008-1

Load Force Ratings

Motors are capable of carrying a radial or axial load. If necessary, please consult with Rockwell Automation regarding loads, operating speeds and bearing life in your particular application to ensure the proper selection of motors.

STANDARD LOAD FORCE RATINGS				
Motor	Radial		Axial	
	kg	lb	kg	lb
Y-1002	10	22	3	6.6
Y-1003				
Y-2006	20	44	8	17.6
Y-2012	25	55	10	22.0
Y-3023	35	77	20	44.0

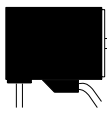

Radial load force applied at point =
 $(2X \text{ Shaft Length}) / 3$.

Axial load force

Brake Motor Application Guidelines

The brakes offered as options on these servo motors are holding brakes. They are designed to hold the motor shaft at 0 rpm for up to the rated brake holding torque. The brakes are spring-set type, and release when voltage is applied to the brake coil.

The brakes are *not* designed for stopping rotation of the motor shaft. Servo drive inputs should be used to stop motor shaft rotation. The recommended method of stopping motor shaft rotation is to command the servo drive to decelerate the motor to 0 rpm, and engage the brake after the servo drive has decelerated the motor to 0 rpm.

If system main power fails, the brakes can withstand use as stopping brakes. However, use of the brakes as stopping brakes creates rotational mechanical backlash that is potentially damaging to the system, increases brake pad wear and reduces brake life. The brakes are *not* designed nor are they intended to be used as a safety device.

A separate power source is required to disengage the brake. This power source may be controlled by the servo motor controls, in addition to manual operator controls.

Brake Specifications

BRAKE DATA			
Motor Series	Holding Torque		Coil Current at 24 VDC
	(Nm)	(Lb/in)	
Y-1002	0.157	1.39	0.26 Amps
Y-1003	0.32	2.83	
Y-2006	0.637	5.64	0.31 Amps
Y-2012	1.27	11.24	
Y-3023	2.38	21.06	0.37 Amps

Encoder Data

Encoders are factory aligned and must not be adjusted outside the factory.

ENCODER SPECIFICATIONS		
Parameter	Value	
Supply:	Voltage Current	4.75 to 5.25 VDC 450 mA DC
Line Driver:	Type Output: Logic 1 Output: Logic 0	AM 26LS31 equivalent Sourcing 2.5 VDC @ 20 mA Sinking 0.5 VDC @ 20mA
Line counts:	Data A+, A-, B+, B-: 2000 pulse/rev Index I+, I-: 1 pulse/rev Hall A+, A-, B+, B-, C+, C-: 2 pulse/rev	
Standard line count before quadrature		

Encoder Data Waveforms Outputs

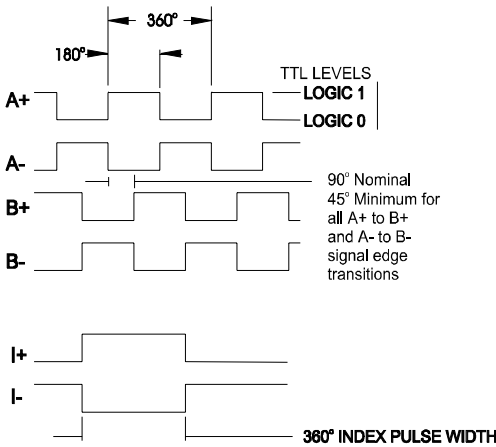

Waveforms result from clockwise rotation. "Clockwise" as viewed facing the shaft extension.

Halls and Phase-to-Phase Waveforms

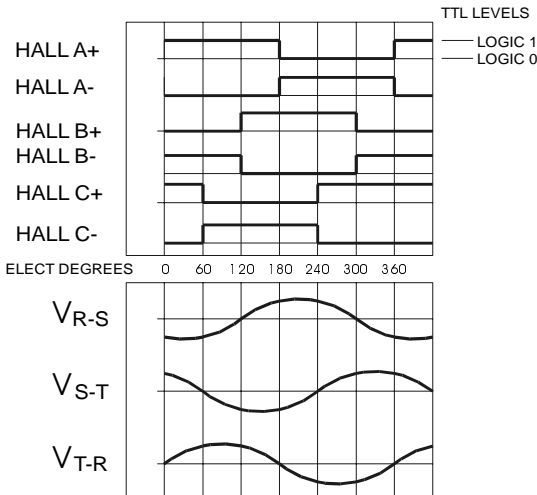

Motor Installation

Observe the following installation guidelines and those in the Product Notice:



WARNING: Motors and linkages must be securely mounted for a system to be operational. Disassembled equipment should be appropriately identified (tagged-out) and access to electrical power restricted (locked-out).

Failure to observe these safety procedures could result in personal injury and damage to equipment.

1. Do not run motors that are not properly mounted. Attach all power and data cables after the motor is mounted.
2. Mount motors with connectors pointing downward and use a drip loop in the cable to keep liquids flowing away from the connectors.
3. Consider motor case temperature if necessary to safeguard operator and maintenance staff. Maximum case temperature is approximately 100°C (212°F) for a motor used at continuous rating in a 40°C ambient temperature.
4. The installer must comply with all local regulations and should use equipment and installation practices that promote electromagnetic compatibility and safety.

Preventing Electrical Noise

ElectroMagnetic Interference (EMI), commonly called “noise”, may adversely impact motor performance by inducing stray signals. Effective techniques to counter EMI include filtering the AC power, shielding and separating signal carrying lines, and practicing good grounding techniques. Effective AC power filtering can be achieved through the use of isolated AC power transformers or properly installed AC line filters. Physically separate signal lines from motor cabling and power wiring; do *not* parallel signal wires with motor or power wires or route signal wires over the vent openings of servo drives. Ground all equipment using a single-point parallel ground system that employs ground bus bars or straps. If necessary, use electrical noise remediation techniques to mitigate EMI in “noisy” environments.

Knowledgeable cable routing and careful cable construction improves system electromagnetic compatibility (EMC). General cable build and installation guidelines include:

1. Keep wire lengths as short as physically possible.
2. Route signal cables (encoder, serial, analog) away from motor and power wiring.
3. Separate cables by 1 foot minimum for every 30 feet of parallel run.
4. Ground both ends of the encoder cable and twist the signal wire pairs.
5. Use shielded motor cables when necessary to prevent electromagnetic interference (EMI) with other equipment.

Couplings and Pulleys

Mechanical connections to the motor shaft, such as couplings and pulleys, require a rigid coupling or a reinforced timing belt. The high dynamic performance of servo motors can cause couplings, pulleys or belts to loosen or slip over time. A loose or slipping connection will cause system instability and may damage the motor shaft and keyway. All connections between the system and the servo motor shaft must be rigid to achieve acceptable response from the system. Connections should be periodically inspected to verify the rigidity.

When mounting couplings or pulleys to the motor shaft, ensure that the connections are properly aligned and that axial and radial loads are within the specifications of the motor. The section “Load Force Ratings” provides guidelines to achieve 20,000 hours of bearing life. Additional information about load force ratings, including graphical depiction of varied load ratings and bearing life, is available for any motor from the Technical Support groups listed on the back cover.

Product Information

Motor Part Number Identification

Y - 2012 - 2 - H 00 AA

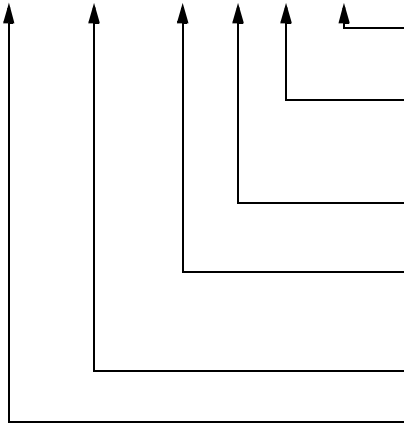

FACTORY DESIGNATED SPECIAL OPTIONS
AA = STANDARD FLANGE

OPTIONS
00 = STANDARD
04 = 24 VDC BRAKE

OPTICAL ENCODER LINE COUNT
H = 2000 (STANDARD)

MOTOR WINDING VOLTAGE DESIGNATOR
1 = 115 VAC
2 = 230 VAC

FRAME SIZE

SERIES DESIGNATOR
Y = Light Industrial

Disposal or Warranty Return of Motors

Motors may contain environmentally regulated materials, such as lead solder and circuit boards. When disposing of a motor, please recycle motors per regulations at your location. You may choose to return a motor for disposal by contacting your supplier.

Please contact the source that supplied the motor for warranty, non-warranty, or disposal work. All returned products require a Return Material Authorization (RMA) number for efficient processing and tracking.

For more information refer to our web site: www.ab.com/motion

Reach us now at www.rockwellautomation.com

Wherever you need us, Rockwell Automation brings together leading brands in industrial automation including Allen-Bradley controls, Reliance Electric power transmission products, Dodge mechanical power transmission components, and Rockwell Software. Rockwell Automation's unique, flexible approach to helping customers achieve a competitive advantage is supported by thousands of authorized partners, distributors and system integrators around the world.

Americas Headquarters, 1201 South Second Street, Milwaukee, WI 53204, USA, Tel: (1) 414 382-2000, Fax: (1) 414 382-4444
European Headquarters SA/NV, avenue Herrmann Debroux, 46, 1160 Brussels, Belgium, Tel: (32) 2 663 06 00, Fax: (32) 2 663 06 40
Asia Pacific Headquarters, 27/F Citicorp Centre, 18 Whitfield Road, Causeway Bay, Hong Kong, Tel: (852) 2887 4788, Fax: (852) 2508 1846



**Rockwell
Automation**