

# Smart Communications Card

## (Cat. No. 1403-NSC)

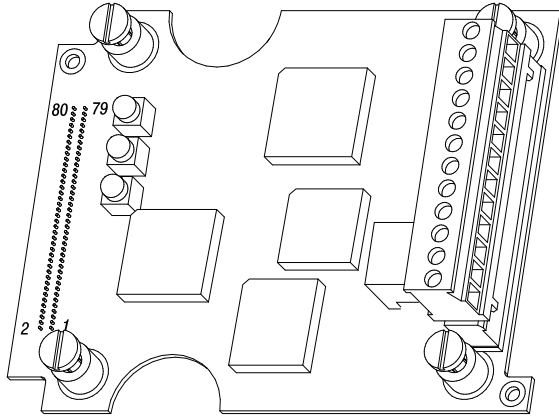

Throughout this manual we use notes to make you aware of safety considerations:



**ATTENTION:** Identifies information about practices or circumstances that can lead to personal injury or death, property damage or economic loss.

Attention statements help you to:

- identify a hazard
- avoid the hazard
- recognize the consequences

**Important:** Identifies information that is critical for successful application and understanding of the product.

### Important User Information

Solid-state equipment has operational characteristics differing from those of electromechanical equipment. *Safety Guidelines for the Application, Installation, and Maintenance of Solid-state Controllers* (Publication SGI-1.1) describes some important differences between solid-state equipment and hard-wired electromechanical devices. Because of this difference, and also because of the wide variety of uses for solid-state equipment, all persons responsible for applying this equipment must satisfy themselves that each intended application of this equipment is acceptable.

In no event will the Allen-Bradley Company, Inc. be responsible for indirect or consequential damages resulting from the use or application of this equipment.

The examples and diagrams in this manual are included solely for illustrative purposes. Because of the many variables and requirements associated with any particular installation, the Allen-Bradley Company, Inc. cannot assume responsibility or liability for actual use based on the examples and diagrams.

No patent liability is assumed by the Allen-Bradley Company, Inc. with respect to use of information, circuits, equipment, or software described in this manual.

Reproduction of the contents of this manual, in whole or in part, without written permission of Allen-Bradley Company, Inc., is prohibited.

### Terms and Conventions

In this instruction sheet, the following terms and conventions are used:

Abbreviation	Term
BTR	Block Transfer Read
BTW	Block Transfer Write
MSG	Message

### Table of Contents

Product Description . . . . .	2
Installation . . . . .	3
General Operation . . . . .	8
Catalog Number Explanation . . . . .	App. A
Smart Communication Card Data Tables . . . . .	App. B
Smart Communication Protocol Tutorial . . . . .	App. C
Sample Ladder Listing . . . . .	App. D
Technical Specifications . . . . .	App. E

PLC is a registered trademark of Allen-Bradley Company, Inc.  
 Data Highway Plus and SLC are trademarks of Allen-Bradley Company, Inc.



## Product Description

### Chapter Objectives

After completing this chapter, you should be able to identify the product features and system applications.

### Introduction

The Cat. No. 1403-NSC Smart Communications Card is a microprocessor-controlled dual-port communication plug-in accessory to the Powermonitor II Master Module. This accessory provides the Powermonitor II with two active communication ports which can be used at the same time. Required configuration parameters (R I/O rack address, baud rates, etc.) are provided by configuring the Master Module. One port is dedicated to the Allen-Bradley PLC<sup>®</sup> R I/O network and the other port is software configurable for either EIA Standards RS-232C or RS-485. (There are no hardware options to configure when the card is installed.)

### Performance Features

The Smart Communication Card performance features include:

- PLC via R I/O
- SLC 500 via R I/O with (1747-SN) Series B or later scanner module
- SLC 500 via DF-1 master slave protocol
- R I/O Baud rates: 57.6K baud-230K baud
- Serial Baud rates: 1,200–19,200 baud
- Simultaneous R I/O and serial communication
- 124 units per subnet, 255 per network via RS-485
- 500 V isolation on communications ports
- Fully software configurable, no hardware jumpers required

Figure 1. Cat. No 1403-NSC Communications Module

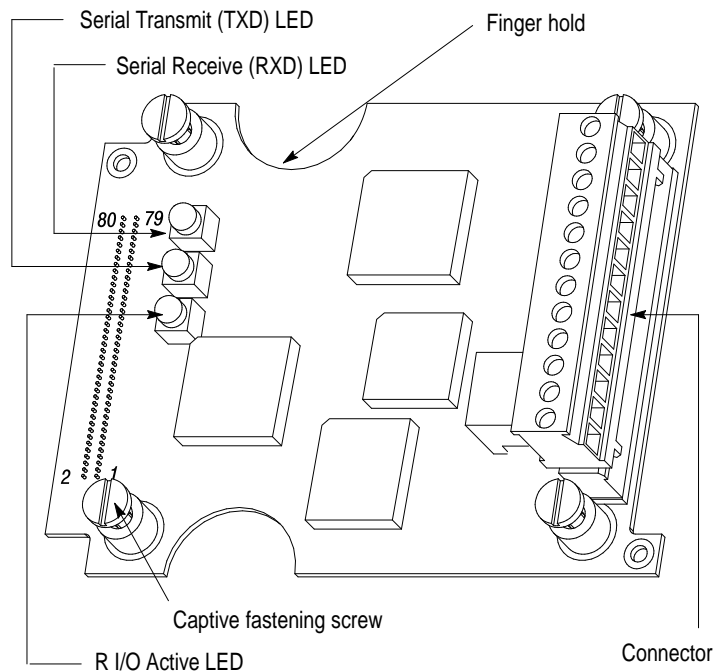

## Installation



**ATTENTION:** Please follow appropriate ESD procedures before removal and/or installation of the Smart Communications Card. Failure to follow these procedures can result in physical damage to both the Smart Communications Card and the Master Module.

1. To remove the blank plate on the Master Module, unscrew the two corner retaining screws as shown in Figure 2. Save these two screws for reassembly.

Figure 2.

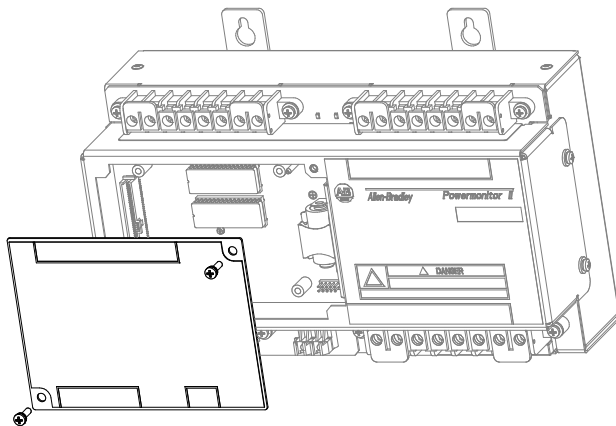

2. If you plan to remove the communications card at a later date, retain the blank plate. Otherwise, dispose of properly.
3. Remove the communications card from the static protection shipping bag.
4. Grasp the card with the components side up and the three LEDs on the left. Place the right index finger in the top notch and the thumb in the bottom notch.

5. With the Master Module labels right side up, place the card into opening on the left side. The card to Master Module connector should align properly when the top right and bottom left guide pins of the Master Module mate with holes in the card. With your left thumb, press just above the card to Master Module connector to attach the connector. Tighten the four corner screws.

Figure 3.

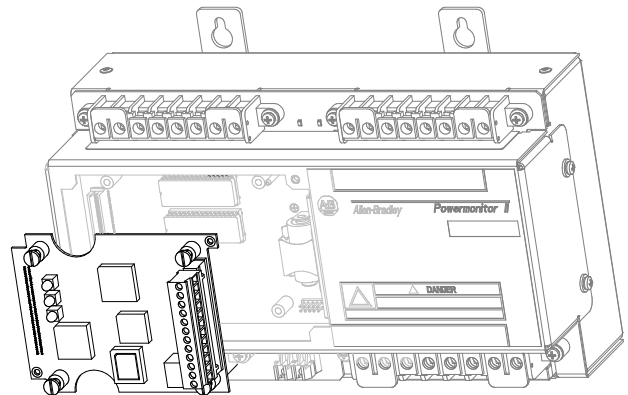

6. Place the closure plate over the opening and secure it with the two screws from the original blank plate.

Figure 4.

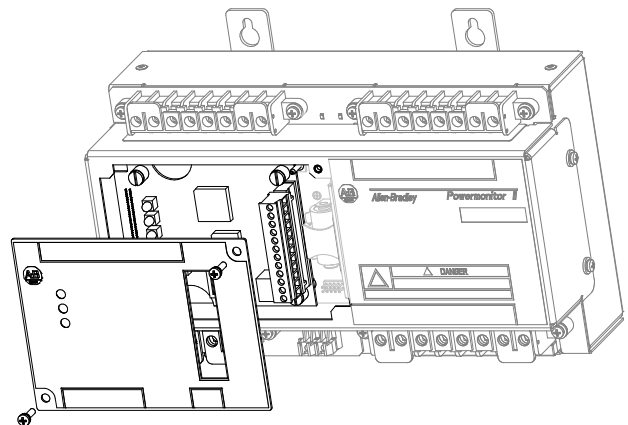

**Note:** Refer to Appendix E, Specifications for screw torque requirements and wire sizes.

## Wiring



**ATTENTION:** Special high level isolation is required between units when the possibility of high ground potential differences exist. This may occur when separate grounds are used or when communicating to a unit connected to a power ground mat. Failure to do so can lead to personal injury or death, property damage, or economic loss.

**Table A. Wiring Connections**

Connector	Communication Format	Terminal # (Counting from the bottom up)	Terminal Label	Intended Use, Pin Connection, or Wire Color	Recommended Cable Type	Maximum Cable Length/Baud Rate	
		12		Do not connect			
		11		Do not connect			
	RS-485		10	SHLD	Cable shield grounding point	2-wire shielded (Belden 9841)	4000 ft/19.2kB
			9	-	Minus signal data		
			8	+	Plus signal data		
	RS-232		7	RXD	PC Transmit, DB25, pin 2, (DB9, pin 3)	3-wire Shielded (Belden 9608)	50 ft/19.2kB
			6	TXD	PC Receive, DB25, pin3 (DB9, pin 2)		
			5	SG	PC signal return, DB25, pin 7 (DB9, pin 5)		
			4	SHLD	Cable Shield		
	R-I/O		3	1	Blue Wire insulation	1770-CD Twinaxial (Blue Hose) (Belden 9463)	10,000 ft /57.6kBaud 5,000 ft/115.2kBaud 2,500 ft/230.4kBaud
			2	SHLD	Cable shield ground point		
			1	2	Clear wire insulation		

### Notes:

- The communications topology for both R I/O and RS-485 is designed to operate in a daisy-chain topology. Use of the star or bridging method will cause signal distortion unless impedances are matched for each spur. Bridging is not recommended without matching networks.
- To prevent end reflections, each end of the daisy-chain should be terminated in the characteristic impedance for the cable, the baud rate, and frequency used.
- Each end section of cable should have the shield connected to the terminal labeled SHLD. This SHLD ground provides a high frequency ground, while limiting DC or power line frequencies from flowing down the cable shield.
- The RS-485 receivers in the communications card provide a 1/4 load impedance instead of the normal full load impedance. This therefore allows the use of four times the number of receivers ( $32 \times 4$  or 128 total) on one network.

Communication Format	Baud Rate	Terminating Resistor
RS-485	1200–19.2k	150 $\Omega$ 1/4 W
R I/O	57.6–115.2k	150 $\Omega$ 1/4 W
	230.4k	84 $\Omega$ 1/4 W

Figure 5. R I/O Wiring

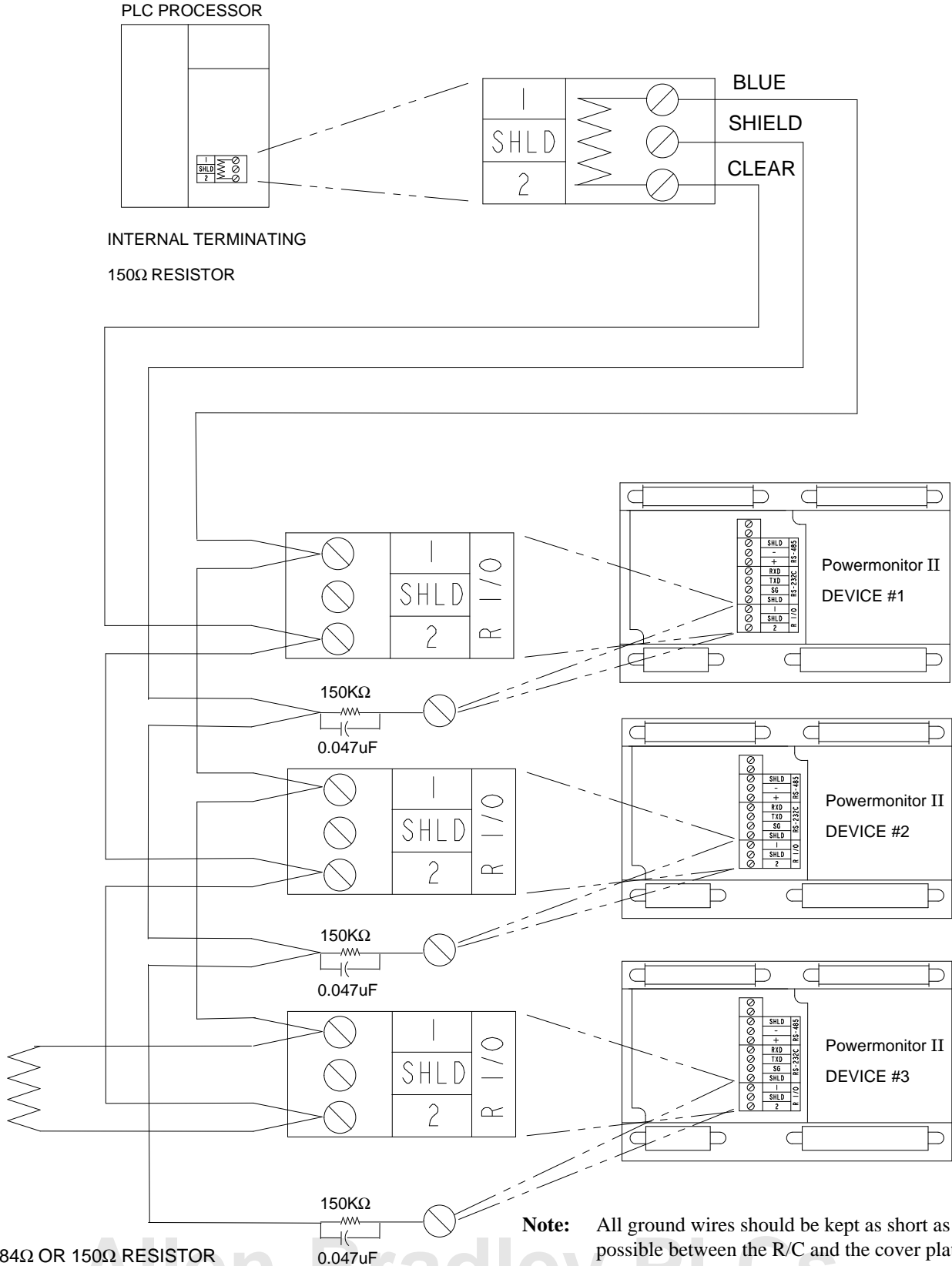

Allen-Bradley PLCs

Figure 6. RS-485 Wiring

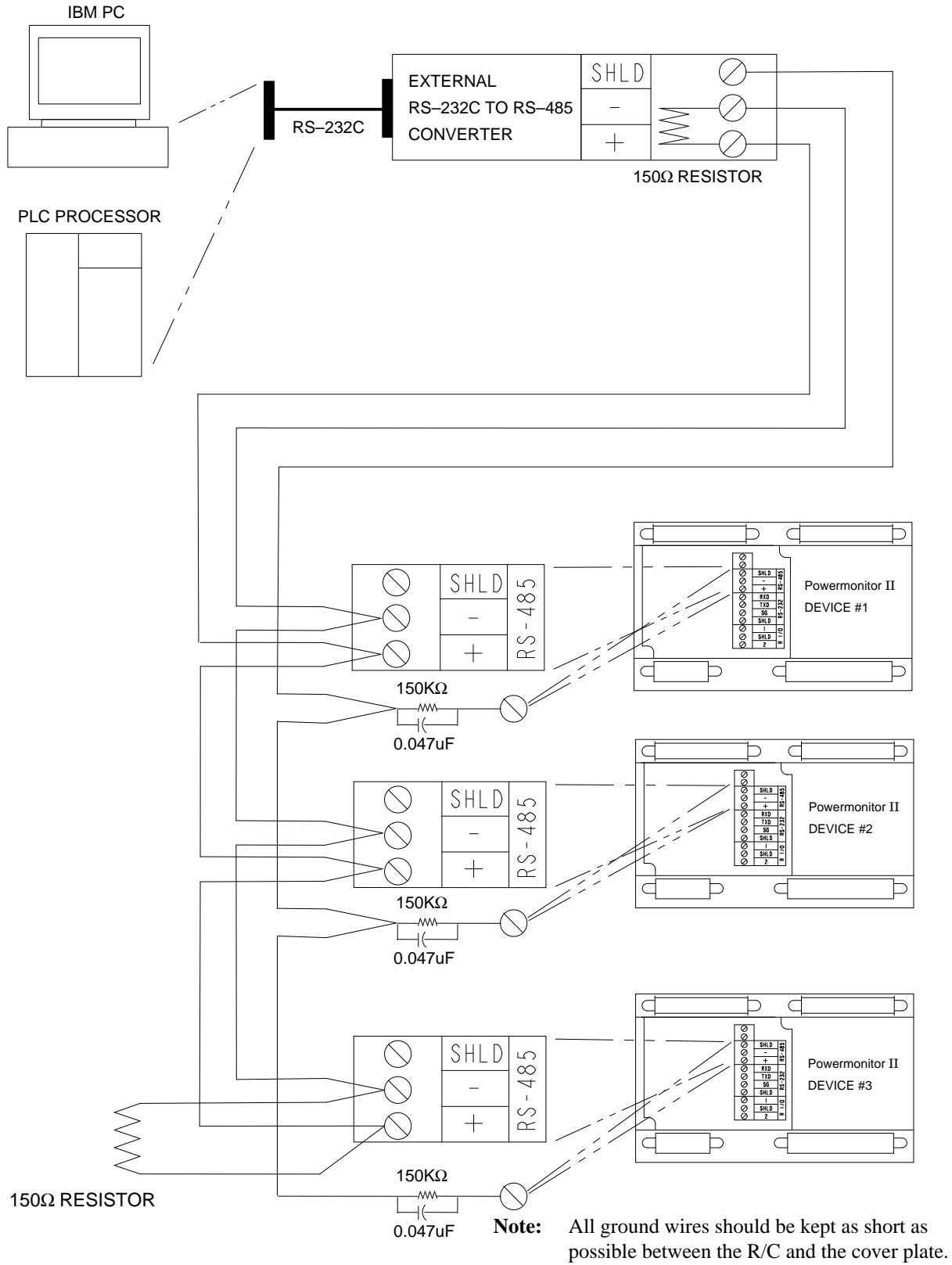
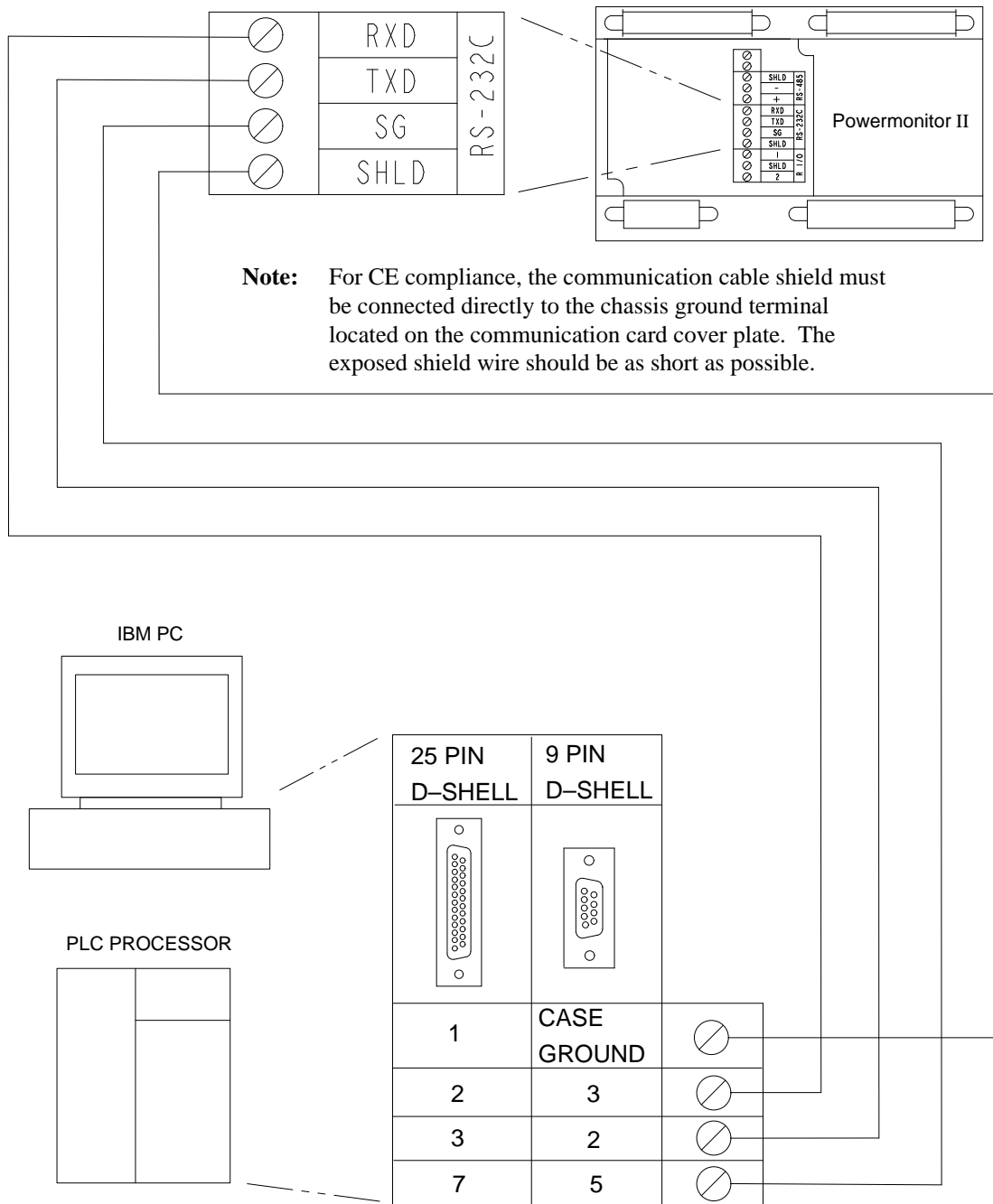

Figure 7. RS-232C Wiring



### Field Service Considerations

If the Smart Communications Card requires service, please contact your nearest Allen-Bradley Sales Office. To minimize your inconvenience, the initial installation should be performed in a manner which makes removal easy.

## General Operation

### Communications Card Set-Up

All communications card options such as communications format, baud rate, address, etc., are set by configuring the Master Module. Refer to *Powermonitor II Instruction Sheet*, Publication 1403-5.0, Chapter 4.

### Indicators

Figure 1. on page 2 shows the location of the LED Indicators on the communications card.

**Table B. LED Indicators**

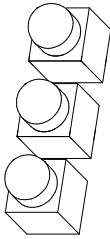
	LED Location	LED Color	Port Assignment	LED State and Communications Condition
	Top	Red	RS-232 or RS-485 Receive	OFF = Idle ON/OFF Pulsing = Receiving Data
	Middle	Red	RS-232 or RS-485 Transmit	OFF = Idle ON/OFF Pulsing = Transmitting Data
	Bottom	Green	R I/O	ON = Communications Established ON/OFF Blinking = Communications Established With Some Errors OFF = Communications Not Established

## Configuration Items

### Communication

**Table C. Communication Configuration Items**

Parameter	Description	Range	Default	User Setting
R I/O Rack Address	Specifies the logical rack of the Smart Communication Card.	0 to 63	1	
R I/O Group Number	Determines the group number of the logical rack.	0 = First Quarter 2 = Second Quarter 4 = Third Quarter 6 = Fourth Quarter	0 = First Quarter	
R I/O Last Rack	Defines whether or not the configured rack is the last rack.	0 = No 1 = Yes	0 = No	
R I/O Baud Rate	Specifies the baud rate of the RIO network.	0 to 56K 1 to 115K 2 to 230K	0 to 56K	
Serial Delay	Defines the delay in ms between the request and response serial packets.	0 to 15	0	
Serial Mode	Specifies the serial communications mode.	0 = RS-485 1 = RS-232	1 = RS-232	
RS-232/RS-485 Baud Rate	Determines the baud rate for the serial communications.	0 to 1200 1 to 2400 2 to 4800 3 to 9600 4 to 19200	3 to 9600	
Serial Device Identifier	Defines the specific serial address. A value of <b>255</b> is used as a broadcast address.	0 to 254	Device ID#	



---

## Catalog Number Explanation

### Communications Cards

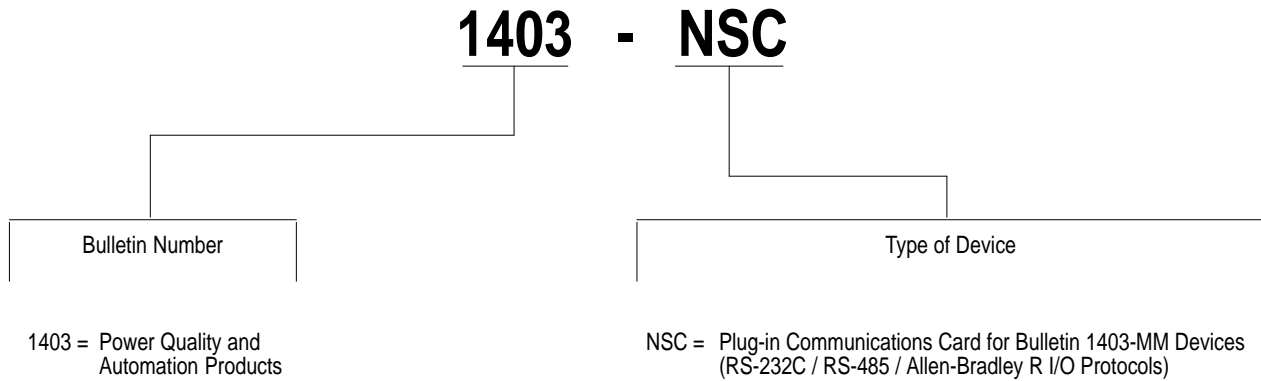



## Smart Communication Card Data Tables

Table B.1 Data Table List

Table Name	Number of Parameters	ID/Number of Words	Type of Table	Page
Device Configuration Data Table	32	44	Block Transfer Read/Write	B-2
Smart Communication Card Data Table	21	30	Block Transfer Read/Write	B-4
Command Data Table	12	22	Block Transfer Write	B-5
Bit Fields for Command Data Table (Command Word 1)	—	—	—	B-6
Bit Fields for Command Data Table (Command Word 2)	—	—	—	B-6
Voltage/Current Data	23	53	Block Transfer Read	B-6
Real Time Power Data	25	62	Block Transfer Read	B-7
Cumulative Power Data	7	45	Block Transfer Read	B-9
Demand Data	18	42	Block Transfer Read	B-10
Event Log	12	23	Block Transfer Read	B-11
Voltage/Current/Miscellaneous Snapshot Log Data Table	28	54	Block Transfer Read	B-12
Power Snapshot Log Data Table	30	59	Block Transfer Read	B-13
Min_Max Log	8	24	Block Transfer Read	B-15
Log Selection Command Table	4	9	Block Transfer Write	B-16
Available Min/Max Log Parameters	84	—	—	B-17
Even Harmonic Distortion Table	29	60	Block Transfer Read	B-18
Odd Harmonic Distortion Table	29	61	Block Transfer Read	B-19
Even Harmonic Magnitude Data Table	29	58	Block Transfer Read	B-21
Odd Harmonic Magnitude Data Table	29	57	Block Transfer Read	B-22
Even Harmonic Phase Angle Data Table	29	56	Block Transfer Read	B-24
Odd Harmonic Phase Angle Data Table	29	55	Block Transfer Read	B-25
Oscillogram Capture Data	54	63	Block Transfer Read	B-27
Diagnostic Data Table (Self-test Results)	35	39	Block Transfer Read	B-29
Setpoint Setup Data Table	9	20	Block Transfer Read/Write	B-30
Setpoint Type	—	—	—	B-31
Setpoint Action	—	—	—	B-31
Relay/Setpoint Status Table	29	38	Block Transfer Read	B-32
Status Inputs Bitfield Definitions	16 bits	—	—	B-33
Alarm Word Bitfield Definitions	16 bits	—	—	B-33
Setpoint Status Bitfield Definitions	16 bits	—	—	B-33

Table B.2 Device Configuration Data Table – Write and Read

Parameter No.	Parameter Name	Master Module Range	Default Setting	Word No.	Range
1.1	Voltage Mode	0 = Demo 1 = Single 2 = Open Delta 3 = 3-Wire Delta 4 = 4-Wire Wye 5 = Direct Delta	4	1	0 to 5
1.2	Present Unit Password	-1 is always returned on a Read 0 to 9999 is required for a Write	0	2	-1 to +9999
1.3	New Password	-1 does not change the password 0 to 9999 is new password value	0	3	-1 to +9999
1.4	Voltage Scale PT Primary	1.0 to 10,000,000.0	120.0	4	0 to 9999
				5	$10^{\pm 0}$ to 21
1.5	Voltage Scale PT Secondary	1 to 999	120	6	1 to 999
1.6	Current Scale (For I1, I2, I3) CT Primary	1.0 to 10,000,000.0	1 or 5 <sup>①</sup>	7	0 to 9999
				8	$10^{\pm 0}$ to 21
1.7	Current Scale (For I1, I2, I3) CT Secondary	1 to 999	1 or 5 <sup>①</sup>	9	1 to 999
1.8	Analog Input Scale PT Primary	1.0 to 10,000,000.0	1.0	10	0 to 9999
				11	$10^{\pm 0}$ to 21
1.9	Analog Input Scale PT Secondary	1 to 999	1	12	1 to 999
1.10	Neutral Current Scale (For I4) CT Primary	1.0 to 10,000,000.0	1 or 5 <sup>①</sup>	13	0 to 9999
				14	$10^{\pm 0}$ to 21
1.11	Neutral Current Scale (For I4) CT Secondary	1 to 999	1 or 5 <sup>①</sup>	15	1 to 999
1.12	Demand Period Length	-99 to +99	1	16	-99 to +99
1.13	Number of Demand Periods	1 to 15	1	17	1 to 15
1.14	Reserved Word		0	18	
1.15	Snapshot Interval – Hours		0	19	0 to 32,767
1.16	Snapshot Interval – Minutes		0	20	0 to 32,767
1.17	Snapshot Interval – Seconds		0	21	0 to 32,767
1.18	Snapshot Buffer Type	0 = Fill and Stop 1 = Circular	1	22	0 to 1
	Reserved Word		0	23	
	Reserved Word		0	24	
	Reserved Word		0	25	
	Reserved Word		0	26	

Parameter No.	Parameter Name	Master Module Range	Default Setting	Word No.	Range
	Reserved Word		0	27	
1.19	Output Pulse Relay No.	0 = None 1 = Relay 1 2 = Relay 2	0	28	0 to 2
1.20	Output Pulse Parameter	0 = kWh Forward 1 = kWh Reverse 2 = kVarh Forward 3 = kVarh Reverse	0	29	0 to 3
1.21	Output Pulse Increment	1 to 32766	1	30	1 to 32766
1.22	Output Pulse Width (ms)	40 to 2000	100	31	40 to 2000
1.23	Ch A 12 Cycle Oscillogram	1 = Phase 1 Voltage 2 = Phase 1 Current 3 = Phase 2 Voltage 4 = Phase 2 Current 5 = Phase 3 Voltage 6 = Phase 3 Current 7 = Phase 4 Current	1	32	1 to 7
1.24	Ch B 12 Cycle Oscillogram	1 = Phase 1 Voltage 2 = Phase 1 Current 3 = Phase 2 Voltage 4 = Phase 2 Current 5 = Phase 3 Voltage 6 = Phase 3 Current 7 = Phase 4 Current	2	33	1 to 7
1.25	Oscillography Type	0 = Hold 1 = Overwrite	1	34	0 to 1
1.26	Number of Pretrigger Cycles for the 12 Cycle Oscillogram	-1 = No Pretrig 0 to +8 = Cycles	0	35	-1 to +8
1.27	IEEE 519 Max. Short Circuit Current	0.0 to 10,000,000.0	0	36	0 to 9999
				37	10 <sup>±0 to 21</sup>
1.28	IEEE 519 Max. Demand/Load Current	0.0 to 10,000,000.0	0	38	0 to 9999
				39	10 <sup>±0 to 21</sup>
1.29	Save Status Changes to Event Log	0 = No 1 = Yes	0	40	0 to 1
1.30	Vaux Voltage Mode	0 = AC 1 = DC	0	41	0 to 1
1.31	Enable THD	0 or 1	1	42	0 to 1
1.32	Enable Min_Max Log	0 = No 1 = Yes	1	43	0 to 1
1.33	Data Format	0 = Integer/Exponent 1 = Floating Point	0	44	0 to 1

① This value will be 1 for 1 Amp Master Module (Cat. No. 1403-MM01X) or 5 for a 5 Amp Master Module (Cat. No. 1403-MM05X).

Table B.3 Smart Communication Card Data Table – Write and Read

**Note:** The device will not respond to a broadcast of this table.

Parameter No.	Parameter Name	Master Module Range	PLC Word No.	Range
2.1	R I/O Rack Address	0 to 63	1	0 to 63
2.2	R I/O Group Number	0 to 6	2	0 to 6
2.3	R I/O Last Rack	0 = No – Default 1 = Yes	3	0 to 1
2.4	R I/O Baud Rate	0 = 56K – Default 1 = 115K 2 = 230K	4	0 to 2
2.5	Serial Response Delay	0 to 15	5	0 to 15
2.6	Serial Type Specifier RS-232 or RS-485	0 = RS-485 1 = RS-232 – Default	6	0 to 1
2.7	SCC RS-232/RS-485 Baud Rate	0 = 1200 1 = 2400 2 = 4800 3 = 9600 – Default 4 = 19200	7	0 to 4
2.8	Serial Device Identifier	0 to 255	8	0 to 255
2.9	R I/O Port Data Format	0 = Integer/Exponent 1 = Floating Point	9	0 to 1
2.10	Serial Port Data Format	0 = Integer/Exponent 1 = Floating Point	10	0 to 1
2.11	Reserved		11	
2.12	Reserved		12	
2.13	Reserved		13	
2.14	Reserved		14	
2.15	Reserved		15	
2.16	Reserved		16	
2.17	Reserved		17	
2.18	Reserved		18	
2.19	Reserved		19	
2.20	Reserved		20	
2.21	Present Unit Password	-1 is always returned for a Read 0 to 9999 is required for a Write	21	-1 to +9999
	Reserved		22	
	Reserved		23	
	Reserved		24	
	Reserved		25	
	Reserved		26	
	Reserved		27	
	Reserved		28	
	Reserved		29	
	Reserved		30	

Table B.4 Command Data Table Write

Parameter No.	Parameter Name	Master Module Range	Word No.	Range
3.1	Command Word 1 (Bit Fields)	0 to 2047	1	0 to 2047
3.2	Command Word 2 (Bit Fields)	0 to 511	2	0 to 511
3.3	Harmonic Analysis <sup>①</sup>	1 = L1 Voltage 2 = L1 Current 3 = L2 Voltage 4 = L2 Current 5 = L3 Voltage 6 = L3 Current 7 = L4 Current	3	1 to 7
3.4	Oscillogram Channel Request <sup>①</sup> (Reserved 1403-LM)	1 = L1 Voltage 2 = L1 Current 3 = L2 Voltage 4 = L2 Current 5 = L3 Voltage 6 = L3 Current 7 = L4 Current 8 = Ch-A 12 Cycle 9 = Ch-B 12 Cycle	4	1 to 9
3.5	W Hour Data for Set Command <sup>①</sup>	-9999x10 <sup>8</sup> to +9999x10 <sup>8</sup>	5	-9999 to 9999
			6	10 <sup>±0</sup> to 21
3.6	VAR Hour Data for Set Command <sup>①</sup>	-9999x10 <sup>8</sup> to +9999x10 <sup>8</sup>	7	-9999 to 9999
			8	10 <sup>±0</sup> to 21
3.7	Reserved		9	9
			10	10
3.8	Time for Set Command <sup>①</sup>	Year	11	0-99 16 Bit Integer
		Month, Day	12	1-12 8 Bit   1-31 8 Bit
		Hour, Minutes	13	0-23 8 Bit   0-59 8 Bit
		Seconds, Hundredths	14	0-59 8 Bit   0-99 8 Bit
3.9	Force Specifics Relay 1 <sup>①</sup>	1 = Energize 2 = De-energize 4 = Remove Force	15	1, 2, 4
3.10	Force Specifics Relay 2 <sup>①</sup>	1 = Energize 2 = De-energize 4 = Remove Force	16	1, 2, 4
3.11	Setpoint Number <sup>①</sup>	1 to 20	17	1 to 20
3.12	Present Unit Password	0 to 9999	18	0 to 9999
	Reserved		19	
	Reserved		20	
	Reserved		21	
3.13	Data Format	0 = Integer/Exponent 1 = Floating Point	22	0 to 1

<sup>①</sup> See Table B.5 in Publication 1403-5.1 for specific command bits to enable these features.

Table B.5 Bit Fields for Command Data Table –  
(Command Word 1)

Command	Bit Location and Value
Clear Snapshot Log	b0 = 1
Clear Min_Max Log	b1 = 1
Restore Factory Default Configuration	b2 = 1
Clear Hold of Oscillogram (Reserved 1403-LM)	b3 = 1
Initiate Oscillogram (Reserved 1403-LM)	b4 = 1
Force Self Test	b5 = 1
Clear Status Input Counter 1	b6 = 1
Clear Status Input Counter 2	b7 = 1
Clear Status Input Counter 3	b8 = 1
Clear Status Input Counter 4	b9 = 1
Clear Battery Usage Timer	b10 = 1

Table B.6 Bit fields for Command Data Table –  
(Command Word 2)

Command	Bit Location and Value
Set Analysis Channel Request	b0 = 1
Set Oscillogram Channel Request (Reserved 1403-LM)	b1 = 1
Set W Hours	b2 = 1
Set VAR Hours	b3 = 1
Reserved	b4 = not used
Set Time	b5 = 1
Relay 1	b6 = 1
Relay 2	b7 = 1
Select Setpoint Number	b8 = 1

Table B.7 Voltage/Current Data – Read

Parameter No.	Parameter Name	Master Module Range	Word No.	Range
4.1	Time Stamp	Year	1	0–99 16 Bit Integer
		Month, Date	2	1–12 8 Bit   1–31 8 Bit
		Hour, Minute	3	0–23 8 Bit   0–59 8 Bit
		Seconds, Hundredths	4	0–59 8 Bit   0–99 8 Bit
4.2	L1 Current	0 to 9999x10 <sup>21</sup> amps	5	0 to 9999
			6	10 <sup>±0</sup> to 2 <sup>1</sup>
4.3	L2 Current	0 to 9999x10 <sup>21</sup> amps	7	0 to 9999
			8	10 <sup>±0</sup> to 2 <sup>1</sup>
4.4	L3 Current	0 to 9999x10 <sup>21</sup> amps	9	0 to 9999
			10	10 <sup>±0</sup> to 2 <sup>1</sup>
4.5	L4 (Neutral) Current	0 to 9999x10 <sup>21</sup> amps	11	0 to 9999
			12	10 <sup>±0</sup> to 2 <sup>1</sup>
4.6	3-Phase Average Current	0 to 9999x10 <sup>21</sup> amps	13	0 to 9999
			14	10 <sup>±0</sup> to 2 <sup>1</sup>
4.7	Positive Sequence Current	0 to 9999x10 <sup>21</sup> amps	15	0 to 9999
			16	10 <sup>±0</sup> to 2 <sup>1</sup>
4.8	Negative Sequence Current	0 to 9999x10 <sup>21</sup> amps	17	0 to 9999
			18	10 <sup>±0</sup> to 2 <sup>1</sup>
4.9	Percent Current Unbalance	0.0 to 100.0	19	0 to 9999
			20	10 <sup>±0</sup> to 2 <sup>1</sup>
4.10	L1 to L2 Voltage	0 to 9999x10 <sup>21</sup> volts	21	0 to 9999
			22	10 <sup>±0</sup> to 2 <sup>1</sup>
4.11	L2 to L3 Voltage	0 to 9999x10 <sup>21</sup> volts	23	0 to 9999
			24	10 <sup>±0</sup> to 2 <sup>1</sup>
4.12	L3 to L1 Voltage	0 to 9999x10 <sup>21</sup> volts	25	0 to 9999
			26	10 <sup>±0</sup> to 2 <sup>1</sup>
4.13	AUX Voltage	0 to 9999x10 <sup>21</sup> volts	27	0 to 9999



Parameter No.	Parameter Name	Master Module Range	Word No.	Range
			28	$10^{\pm 0}$ to $2^1$
4.14	3-Phase Average Voltage (L-L)	0 to $9999 \times 10^{21}$ volts	29	0 to 9999
			30	$10^{\pm 0}$ to $2^1$
4.15	Positive Sequence Voltage	0 to $9999 \times 10^{21}$ volts	31	0 to 9999
			32	$10^{\pm 0}$ to $2^1$
4.16	Negative Sequence Voltage	0 to $9999 \times 10^{21}$ volts	33	0 to 9999
			34	$10^{\pm 0}$ to $2^1$
4.17	Percent Voltage Unbalance	0.0 to 100.0	35	0 to 9999
			36	$10^{\pm 0}$ to $2^1$
4.18	L1-N Voltage	0 to $9999 \times 10^{21}$ volts	37	0 to 9999
			38	$10^{\pm 0}$ to $2^1$
4.19	L2-N Voltage	0 to $9999 \times 10^{21}$ volts	39	0 to 9999
			40	$10^{\pm 0}$ to $2^1$
4.20	L3-N Voltage	0 to $9999 \times 10^{21}$ volts	41	0 to 9999
			42	$10^{\pm 0}$ to $2^1$
4.21	3-Phase Average Voltage (L-N)	0 to $9999 \times 10^{21}$ volts	43	0 to 9999
			44	$10^{\pm 0}$ to $2^1$
4.22	Average Frequency	20.0 to 132.0	45	0 to 9999
			46	$10^{\pm 0}$ to $2^1$
4.23	Last Cycle Frequency	20.0 to 132.0	47	0 to 9999
			48	$10^{\pm 0}$ to $2^1$
4.24	Phase Rotation	0 = No Rotation 1 = ABC 2 = ACB	49	0 to 2
	Reserved Word		50	
	Reserved Word		51	
	Reserved Word		52	
4.25	Data Format	0 = Integer/Exponent 1 = Floating Point	53	0 to 1

Table B.8 Real Time Power Data – Read

Parameter No.	Parameter Name	Master Module Range	Word No.	Range
5.1	Time Stamp	Year	1	0-99 16 Bit Integer
			2	1-12 8 Bit    1-31 8 Bit
			3	0-23 8 Bit    0-59 8 Bit
			4	0-59 8 Bit    0-99 8 Bit
5.2	L1 Real Power	0 to $9999 \times 10^{21}$ W	5	0 to 9999
			6	$10^{\pm 0}$ to $2^1$
5.3	L2 Real Power	0 to $9999 \times 10^{21}$ W	7	0 to 9999
			8	$10^{\pm 0}$ to $2^1$
5.4	L3 Real Power	0 to $9999 \times 10^{21}$ W	9	0 to 9999
			10	$10^{\pm 0}$ to $2^1$
5.5	Total Real Power	0 to $9999 \times 10^{21}$ W	11	0 to 9999
			12	$10^{\pm 0}$ to $2^1$
5.6	L1 Reactive Power	0 to $9999 \times 10^{21}$ VAR	13	0 to 9999
			14	$10^{\pm 0}$ to $2^1$

Parameter No.	Parameter Name	Master Module Range	Word No.	Range
5.7	L2 Reactive Power	0 to 9999x10 <sup>21</sup> VAR	15	0 to 9999
			16	10 <sup>±0</sup> to 2 <sup>1</sup>
5.8	L3 Reactive Power	0 to 9999x10 <sup>21</sup> VAR	17	0 to 9999
			18	10 <sup>±0</sup> to 2 <sup>1</sup>
5.9	Total Reactive Power	0 to 9999x10 <sup>21</sup> VAR	19	0 to 9999
			20	10 <sup>±0</sup> to 2 <sup>1</sup>
5.10	L1 Apparent Power	0 to 9999x10 <sup>21</sup> VA	21	0 to 9999
			22	10 <sup>±0</sup> to 2 <sup>1</sup>
5.11	L2 Apparent Power	0 to 9999x10 <sup>21</sup> VA	23	0 to 9999
			24	10 <sup>±0</sup> to 2 <sup>1</sup>
5.12	L3 Apparent Power	0 to 9999x10 <sup>21</sup> VA	25	0 to 9999
			26	10 <sup>±0</sup> to 2 <sup>1</sup>
5.13	Total Apparent Power	0 to 9999x10 <sup>21</sup> VA	27	0 to 9999
			28	10 <sup>±0</sup> to 2 <sup>1</sup>
5.14	L1 True PF	-100.0 to +100.0	29	-9999 to +9999
			30	10 <sup>±0</sup> to 2 <sup>1</sup>
5.15	L2 True PF	-100.0 to +100.0	31	-9999 to +9999
			32	10 <sup>±0</sup> to 2 <sup>1</sup>
5.16	L3 True PF	-100.0 to +100.0	33	-9999 to +9999
			34	10 <sup>±0</sup> to 2 <sup>1</sup>
5.17	Total True PF	-100.0 to +100.0	35	-9999 to +9999
			36	10 <sup>±0</sup> to 2 <sup>1</sup>
5.18	L1 Displacement PF <sup>①</sup>	-100.0 to +100.0	37	-9999 to +9999
			38	10 <sup>±0</sup> to 2 <sup>1</sup>
5.19	L2 Displacement PF <sup>①</sup>	-100.0 to +100.0	39	-9999 to +9999
			40	10 <sup>±0</sup> to 2 <sup>1</sup>
5.20	L3 Displacement PF <sup>①</sup>	-100.0 to +100.0	41	-9999 to +9999
			42	10 <sup>±0</sup> to 2 <sup>1</sup>
5.21	Total Displacement PF <sup>①</sup>	-100.0 to +100.0	43	-9999 to +9999
			44	10 <sup>±0</sup> to 2 <sup>1</sup>
5.22	L1 Distortion PF <sup>①</sup>	0 to +100.0	45	0 to 9999
			46	10 <sup>±0</sup> to 2 <sup>1</sup>
5.23	L2 Distortion PF <sup>①</sup>	0 to +100.0	47	0 to 9999
			48	0 <sup>±0</sup> to 2 <sup>1</sup>
5.24	L3 Distortion PF <sup>①</sup>	0 to +100.0	49	0 to 9999
			50	0 <sup>±0</sup> to 2 <sup>1</sup>
5.25	Total Distortion PF <sup>①</sup>	0 to +100.0	51	0 to 9999
			52	10 <sup>±0</sup> to 2 <sup>1</sup>
	Reserved Word		53	
	Reserved Word		54	
	Reserved Word		55	
	Reserved Word		56	
	Reserved Word		57	
	Reserved Word		58	
	Reserved Word		59	
	Reserved Word		60	
	Reserved Word		61	
5.26	Data Format	0 = Integer/Exponent 1 = Floating Point	62	0 to 1

<sup>①</sup> This value has the same update rate as harmonic analysis.

Table B.9 Cumulative Power Data – Read

Parameter No.	Parameter Name	Master Module Range	Word No.	Range	Modulus
6.1	Time Stamp	Year	1	0-99 16 Bit Integer	
		Month, Date	2	1-12 8 Bit    1-31 8 Bit	N/A
		Hour, Minute	3	0-23 8 Bit    0-59 8 Bit	N/A
		Seconds, Hundredths	4	0-59 8 Bit    0-99 8 Bit	N/A
6.2	kW Hours Forward	0 to 1.0x10 <sup>12</sup>	5	+0 to 999	10 <sup>12</sup>
			6	+0 to 999	10 <sup>9</sup>
			7	+0 to 999	10 <sup>6</sup>
			8	+0 to 999	10 <sup>3</sup>
			9	+0 to 999	10 <sup>0</sup>
6.3	kW Hours Reverse	-1.0x10 <sup>12</sup> to 0	10	-0 to 999	10 <sup>12</sup>
			11	-0 to 999	10 <sup>9</sup>
			12	-0 to 999	10 <sup>6</sup>
			13	-0 to 999	10 <sup>3</sup>
			14	-0 to 999	10 <sup>0</sup>
6.4	kW Hours Net	-1.0x10 <sup>12</sup> to 1.0x10 <sup>12</sup>	15	±0 to 999	10 <sup>12</sup>
			16	±0 to 999	10 <sup>9</sup>
			17	±0 to 999	10 <sup>6</sup>
			18	±0 to 999	10 <sup>3</sup>
			19	±0 to 999	10 <sup>0</sup>
6.5	kVAR Hours Forward	0 to 1.0x10 <sup>12</sup>	20	+0 to 999	10 <sup>12</sup>
			21	+0 to 999	10 <sup>9</sup>
			22	+0 to 999	10 <sup>6</sup>
			23	+0 to 999	10 <sup>3</sup>
			24	+0 to 999	10 <sup>0</sup>
6.6	kVAR Hours Reverse	-1.0x10 <sup>12</sup> to 0	25	-0 to 999	10 <sup>12</sup>
			26	-0 to 999	10 <sup>9</sup>
			27	-0 to 999	10 <sup>6</sup>
			28	-0 to 999	10 <sup>3</sup>
			29	-0 to 999	10 <sup>0</sup>
6.7	kVAR Hours Net	-1.0x10 <sup>12</sup> to 1.0x10 <sup>12</sup>	30	±0 to 999	10 <sup>12</sup>
			31	±0 to 999	10 <sup>9</sup>
			32	±0 to 999	10 <sup>6</sup>
			33	±0 to 999	10 <sup>3</sup>
			34	±0 to 999	10 <sup>0</sup>
	Reserved Word		35		
	Reserved Word		36		
	Reserved Word		37		
	Reserved Word		38		
	Reserved Word		39		
	Reserved Word		40		
	Reserved Word		41		
	Reserved Word		42		
	Reserved Word		43		
	Reserved Word		44		
	Reserved Word		45		

Table B.10 Demand Data – Read

Parameter No.	Parameter Name	Master Module Range	Word No.	Range
7.1	Time Stamp	Year	1	0-99 16 Bit Integer
		Month, Date	2	1-12 8 Bit    1-31 8 Bit
		Hour, Minute	3	0-23 8 Bit    0-59 8 Bit
		Seconds, Hundredths	4	0-59 8 Bit    0-99 8 Bit
7.2	Demand Current	0 to 9999x10 <sup>21</sup> amps	5	0 to 9999
			6	10 <sup>±0</sup> to 2 <sup>1</sup>
7.3	Demand Power	0 to 9999x10 <sup>21</sup> W	7	0 to 9999
			8	10 <sup>±0</sup> to 2 <sup>1</sup>
7.4	Demand Reactive Power	0 to 9999x10 <sup>21</sup> VAR	9	0 to 9999
			10	10 <sup>±0</sup> to 2 <sup>1</sup>
7.5	Demand Apparent Power	0 to 9999x10 <sup>21</sup> VA	11	0 to 9999
			12	10 <sup>±0</sup> to 2 <sup>1</sup>
7.6	Projected No. 1 Demand Current	0 to 9999x10 <sup>21</sup> amps	13	0 to 9999
			14	0 to 9999
7.7	Projected No. 1 Demand Power	0 to 9999x10 <sup>21</sup> W	15	0 to 9999
			16	10 <sup>±0</sup> to 2 <sup>1</sup>
7.8	Projected No. 1 Demand Reactive Power	0 to 9999x10 <sup>21</sup> VAR	17	0 to 9999
			18	10 <sup>±0</sup> to 2 <sup>1</sup>
7.9	Projected No. 1 Demand Apparent Power	0 to 9999x10 <sup>21</sup> VA	19	0 to 9999
			20	10 <sup>±0</sup> to 2 <sup>1</sup>
7.10	Projected No. 2 Demand Current	0 to 9999x10 <sup>21</sup> amps	21	0 to 9999
			22	10 <sup>±0</sup> to 2 <sup>1</sup>
7.11	Projected No. 2 Demand Power	0 to 9999x10 <sup>21</sup> W	23	0 to 9999
			24	10 <sup>±0</sup> to 2 <sup>1</sup>
7.12	Projected No. 2 Demand Reactive Power	0 to 9999x10 <sup>21</sup> VAR	25	0 to 9999
			26	10 <sup>±0</sup> to 2 <sup>1</sup>
7.13	Projected No. 2 Demand Apparent Power	0 to 9999x10 <sup>21</sup> VA	27	0 to 9999
			28	10 <sup>±0</sup> to 2 <sup>1</sup>
7.14	Projected No. 3 Demand Current	0 to 9999x10 <sup>21</sup> amps	29	0 to 9999
			30	10 <sup>±0</sup> to 2 <sup>1</sup>
7.15	Projected No. 3 Demand Power	0 to 9999x10 <sup>21</sup> W	31	0 to 9999
			32	10 <sup>±0</sup> to 2 <sup>1</sup>
7.16	Projected No. 3 Demand Reactive Power	0 to 9999x10 <sup>21</sup> VAR	33	0 to 9999
			34	10 <sup>±0</sup> to 2 <sup>1</sup>
7.17	Projected No. 3 Demand Apparent Power	0 to 9999x10 <sup>21</sup> VA	35	0 to 9999
			36	10 <sup>±0</sup> to 2 <sup>1</sup>
7.18	Elapsed Time	0 to 9999x10 <sup>21</sup>	37	0 to 9999
			38	10 <sup>±0</sup> to 2 <sup>1</sup>
	Reserved Word		39	
	Reserved Word		40	
	Reserved Word		41	
7.19	Data Format	0 = Integer/Exponent 1 = Floating Point	42	0 to 1

Table B.11 Event Log – Read

Parameter No.	Parameter Name	Master Module Range	Word No.	Range
8.1	Event Time Log Stamp	Year	1	0–99 16 Bit Integer
		Month, Date	2	1–12 8 Bit    1–31 8 Bit
		Hour, Minute	3	0–23 8 Bit    0–59 8 Bit
		Seconds, Hundredths	4	0–59 8 Bit    0–99 8 Bit
8.2	Event Type Value	0 to 14	5	0 to 14
8.3	Event Code Value	0 to 10	6	0 to 10
8.4	Setpoint Type	0 to 54	7	0 to 54
8.5	Setpoint Evaluation Condition	0 to 5	8	0 to 5
8.6	Setpoint Level	$\pm 9999 \times 10^{21}$	9	$\pm 0$ to 9999
			10	$10^{\pm 0}$ to $2^1$
8.7	Setpoint Action/Release Delay	0 to 9999	11	0 to 9999
8.8	Setpoint Action	0 to 20	12	0 to 20
8.9	Number of Event Logs Requested	1 to 100	13	1 to 100
8.10	Number of Event Log Received (Counter)	1 to 100	14	1 to 100
8.11	Number of Event Log Being Returned	1 to 100	15	1 to 100
8.12	Internal Identifier	–32767 to +32767	16	–32767 to +32767
	Reserved Word		17	
	Reserved Word		18	
	Reserved Word		19	
	Reserved Word		20	
	Reserved Word		21	
	Reserved Word		22	
8.13	Data Format	0 = Integer/Exponent 1 = Floating Point	23	0 to 1

Table B.12 Voltage/Current/Miscellaneous Snapshot Log Data Table Read

Parameter No.	Parameter Name	Master Module Parameter Range	Word No.	Range
9.1	Event Time Log Stamp	Year	1	0-99 16 Bit Integer
		Month, Date	2	1-12 8 Bit    1-31 8 Bit
		Hour, Minute	3	0-23 8 Bit    0-59 8 Bit
		Seconds, Hundredths	4	0-59 8 Bit    0-99 8 Bit
9.2	Reserved		5	
9.3	L1 Current	0 to 9999x10 <sup>21</sup> amps	6	0 to 9999
			7	10 <sup>±0</sup> to 21
9.4	L2 Current	0 to 9999x10 <sup>21</sup> amps	8	0 to 9999
			9	10 <sup>±0</sup> to 21
9.5	L3 Current	0 to 9999x10 <sup>21</sup> amps	10	0 to 9999
			11	10 <sup>±0</sup> to 21
9.6	L4 (Neutral) Current	0 to 9999x10 <sup>21</sup> amps	12	0 to 9999
			13	10 <sup>±0</sup> to 21
9.7	3-Phase Average Current	0 to 9999x10 <sup>21</sup> amps	14	0 to 9999
			15	10 <sup>±0</sup> to 21
9.8	Positive Sequence Current	0 to 9999x10 <sup>21</sup> amps	16	0 to 9999
			17	10 <sup>±0</sup> to 21
9.9	Negative Sequence Current	0 to 9999x10 <sup>21</sup> amps	18	0 to 9999
			19	10 <sup>±0</sup> to 21
9.10	Percent Current Unbalance	0.0 to 100.0	20	0 to 9999
			21	10 <sup>±0</sup> to 21
9.11	L1-L2 Voltage	0 to 9999x10 <sup>21</sup> volts	22	0 to 9999
			23	10 <sup>±0</sup> to 21
9.12	L2-L3 Voltage	0 to 9999x10 <sup>21</sup> volts	24	0 to 9999
			25	10 <sup>±0</sup> to 21
9.13	L3-L1 Voltage	0 to 9999x10 <sup>21</sup> volts	26	0 to 9999
			27	10 <sup>±0</sup> to 21
9.14	AUX Voltage	0 to 9999x10 <sup>21</sup> volts	28	0 to 9999
			29	10 <sup>±0</sup> to 21
9.15	3-Phase Average Voltage (L-L)	0 to 9999x10 <sup>21</sup> volts	30	0 to 9999
			31	10 <sup>±0</sup> to 21
9.16	Positive Sequence Voltage	0 to 9999x10 <sup>21</sup> volts	32	0 to 9999
			33	10 <sup>±0</sup> to 21
9.17	Negative Sequence Voltage	0 to 9999x10 <sup>21</sup> volts	34	0 to 9999
			35	10 <sup>±0</sup> to 21
9.18	Percent Voltage Unbalance	0.0 to 100.0	36	0 to 9999
			37	10 <sup>±0</sup> to 21
9.19	L1-N Voltage	0 to 9999x10 <sup>21</sup> volts	38	0 to 9999
			39	10 <sup>±0</sup> to 21
9.20	L2-N Voltage	0 to 9999x10 <sup>21</sup> volts	40	0 to 9999
			41	10 <sup>±0</sup> to 21
9.21	L3-N Voltage	0 to 9999x10 <sup>21</sup> volts	42	0 to 9999
			43	10 <sup>±0</sup> to 21

Parameter No.	Parameter Name	Master Module Parameter Range	Word No.	Range
9.22	3-Phase Average Voltage (L-N)	0 to 9999x10 <sup>21</sup> volts	44	0 to 9999
			45	10 <sup>±0</sup> to 21
	Reserved		46	
	Reserved		47	
9.23	Last Cycle Frequency	20.0 to 132.0	48	0 to 9999
			49	10 <sup>±0</sup> to 21
9.24	Phase Rotation	0 = No Rotation 1 = ABC 2 = ACB	50	0 to 2
9.25	Number of Snapshot Logs Requested	1 to 50	51	1 to 50
9.26	Number of snapshot Log Received (Counter)	1 to 50	52	1 to 50
9.27	Number of Snapshot Log Being Returned	1 to 50	53	1 to 50
9.28	Internal Identifier	-32767 to +32767	54	-32767 to +32767

Table B.13 Power Snapshot Log Data Table

Parameter No.	Parameter Name	Master Module Parameter Range	Word No.	Range
10.1	Event Time Log Stamp	Year	1	0-99 16 Bit Integer
		Month, Date	2	1-12 8 Bit   1-31 8 Bit
		Hour, Minute	3	0-23 8 Bit   0-59 8 Bit
		Seconds, Hundredths	4	0-59 8 Bit   0-59 8 Bit
10.2	Reserved Word		5	
10.3	L1 Real Power	0 to 9999x10 <sup>21</sup> W	6	0 to 9999
			7	10 <sup>±0</sup> to 21
10.4	L2 Real Power	0 to 9999x10 <sup>21</sup> W	8	0 to 9999
			9	10 <sup>±0</sup> to 21
10.5	L3 Real Power	0 to 9999x10 <sup>21</sup> W	10	0 to 9999
			11	10 <sup>±0</sup> to 21
10.6	Total Real Power	0 to 9999x10 <sup>21</sup> W	12	0 to 9999
			13	10 <sup>±0</sup> to 21
10.7	L1 Reactive Power	0 to 9999x10 <sup>21</sup> VAR	14	0 to 9999
			15	10 <sup>±0</sup> to 21
10.8	L2 Reactive Power	0 to 9999x10 <sup>21</sup> VAR	16	0 to 9999
			17	10 <sup>±0</sup> to 21
10.9	L3 Reactive Power	0 to 9999x10 <sup>21</sup> VAR	18	0 to 9999
			19	10 <sup>±0</sup> to 21
10.10	Total Reactive Power	0 to 9999x10 <sup>21</sup> VAR	20	0 to 9999
			21	10 <sup>±0</sup> to 21
10.11	L1 Apparent Power	0 to 9999x10 <sup>21</sup> VA	22	0 to 9999
			23	10 <sup>±0</sup> to 21
10.12	L2 Apparent Power	0 to 9999x10 <sup>21</sup> VA	24	0 to 9999
			25	10 <sup>±0</sup> to 21
10.13	L3 Apparent Power	0 to 9999x10 <sup>21</sup> VA	26	0 to 9999

Parameter No.	Parameter Name	Master Module Parameter Range	Word No.	Range
			27	$10^{\pm 0}$ to 21
10.14	Total Apparent Power	0 to 9999x10 <sup>21</sup> VA	28	0 to 9999
			29	$10^{\pm 0}$ to 21
10.15	L1 True PF	-100.0 to +100.0	30	-9999 to +9999
			31	$10^{\pm 0}$ to 21
10.16	L2 True PF	-100.0 to +100.0	32	-9999 to +9999
			33	$10^{\pm 0}$ to 21
10.17	L3 True PF	-100.0 to +100.0	34	-9999 to +9999
			35	$10^{\pm 0}$ to 21
10.18	Total True PF	-100.0 to +100.0	36	-9999 to +9999
			37	$10^{\pm 0}$ to 21
10.19	L1 Displacement PF	-100.0 to +100.0	38	-9999 to +9999
			39	$10^{\pm 0}$ to 21
10.20	L2 Displacement PF	-100.0 to +100.0	40	-9999 to +9999
			41	$10^{\pm 0}$ to 21
10.21	L3 Displacement PF	-100.0 to +100.0	42	-9999 to +9999
			43	$10^{\pm 0}$ to 21
10.22	Total Displacement PF	-100.0 to +100.0	44	-9999 to +9999
			45	$10^{\pm 0}$ to 21
10.23	L1 Distortion PF	0 to 100.0	46	0 to 9999
			47	$10^{\pm 0}$ to 21
10.24	L2 Distortion PF	0 to 100.0	48	0 to 9999
			49	$10^{\pm 0}$ to 21
10.25	L3 Distortion PF	0 to 100.0	50	0 to 9999
			51	$10^{\pm 0}$ to 21
10.26	Total Distortion PF	0 to 100.0	52	0 to 9999
			53	$10^{\pm 0}$ to 21
10.27	Number of Snapshot Logs Requested	1 to 50	54	1 to 50
10.28	Number of snapshot Log Received (Counter)	1 to 50	55	1 to 50
10.29	Number of Snapshot Log Being Returned	1 to 50	56	1 to 50
10.30	Internal Identifier	-32767 to +32767	57	-32767 to +32767
	Reserved Word		58	
10.31	Data Format	0 = Integer/Exponent 1 = Floating Point	59	0 to 1



Table B.14 Min\_Max Log – Read

Parameter No.	Parameter Name	Master Module Parameter Range	Word No.	Range
11.1	Time Stamp of last Min/Max Log Reset	Year	1	0–99 16 Bit Integer
		Month, Date	2	1–12 8 Bit   1–31 8 Bit
		Hour, Minute	3	0–23 8 Bit   0–59 8 Bit
		Seconds, Hundredths	4	0–59 8 Bit   0–99 8 Bit
11.2	Time Stamp of MIN for Parameter	Year	5	0–99 16 Bit Integer
		Month, Date	6	1–12 8 Bit   1–31 8 Bit
		Hour, Minute	7	0–23 8 Bit   0–59 8 Bit
		Seconds, Hundredths	8	0–59 8 Bit   0–99 8 Bit
11.3	MIN Value for Parameter	0 to 9999x10	9	0 to 9999 $10^{\pm 0 \text{ to } 21}$
			10	
11.4	Time Stamp of MAX for Parameter	Year	11	0–99 16 Bit Integer
		Month, Date	12	1–12 8 Bit   1–31 8 Bit
		Hour, Minute	13	0–23 8 Bit   0–59 8 Bit
		Seconds, Hundredths	14	0–59 8 Bit   0–99 8 Bit
11.5	MAX Value for Parameter	0 to 9999x10 <sup>21</sup>	15	0 to 9999
			16	$10^{\pm 0 \text{ to } 21}$
11.6	Number of Min_Max Logs Requested	1 to 84	17	1 to 84
11.7	Number of Min_Max Log Received (Counter)	1 to 84	18	1 to 84
11.8	Number of Min_Max Log Being Returned	1 to 84	19	1 to 84
	Reserved Word		20	
	Reserved Word		21	
	Reserved Word		22	
	Reserved Word		23	
11.9	Data Format	0 = Integer/Exponent 1 = Floating Point	24	0 to 1

Table B.15 Log Selection Command Table Write

Param. No.	Parameter Name	Master Module Range	Word No.	Range
12.1	Selected Log	23 = Event Log 24 = Min/Max Log 54 = Snapshot V/I Log 59 = Snapshot Power Log	1	23, 24, 54, 59
12.2	Requested Number of Data Sets	1 to 100 for Event Log 1 to 84 for Min/Max Log 1 to 50 for Snapshot V/I Log 1 to 50 for Snapshot Power Log	2	1 to 100 1 to 84 1 to 50 1 to 50
12.3	Chronology of Returned Data	0 = Reverse 1 = Forward <b>Note:</b> Not used for Min/Max Log	3	0 to 1
12.4	First Min/Max Parameter to be Returned	1 to 84	4	1 to 84
	Reserved Word		5	
	Reserved Word		6	
	Reserved Word		7	
	Reserved Word		8	
	Reserved Word		9	

Table B.16 Available Min/Max Log Parameters (Identifiers for parameter 12.4)

Parameter Number	Parameter Description	Parameter Number	Parameter Description
1	Phase 1 Current	43	Phase 2 Distortion Power Factor
2	Phase 2 Current	44	Phase 3 Distortion Power Factor
3	Phase 3 Current	45	Total Distortion Power Factor
4	Phase 4 Current	46	Current Demand
5	Average Current	47	Real Power Demand
6	Positive Sequence Current	48	Reactive Power Demand
7	Negative Sequence Current	49	Apparent Power Demand
8	Current Unbalance	50	Phase 1 Voltage IEEE THD
9	Phase 1 L-L Voltage	51	Phase 1 Voltage IEC THD
10	Phase 2 L-L Voltage	52	Phase 1 Voltage TIF <sup>①</sup>
11	Phase 3 L-L Voltage	53	Phase 1 Voltage Crest Factor <sup>①</sup>
12	Auxiliary Voltage	54	Phase 1 Voltage K-factor <sup>①</sup>
13	Average L-L Voltage	55	Phase 1 Current IEEE THD
14	Positive Sequence Voltage	56	Phase 1 Current IEC THD
15	Negative Sequence Voltage	57	Phase 1 Current TIF <sup>①</sup>
16	Voltage Unbalance	58	Phase 1 Current Crest Factor <sup>①</sup>
17	Phase 1 L-N Voltage	59	Phase 1 Current K-factor <sup>①</sup>
18	Phase 2 L-N Voltage	60	Phase 2 Voltage IEEE THD
19	Phase 3 L-N Voltage	61	Phase 2 Voltage IEC THD
20	Average L-N Voltage	62	Phase 2 Voltage TIF <sup>①</sup>
21	Frequency	63	Phase 2 Voltage Crest Factor <sup>①</sup>
22	Phase 1 Real Power	64	Phase 2 Voltage K-factor <sup>①</sup>
23	Phase 2 Real Power	65	Phase 2 Current IEEE THD
24	Phase 3 Real Power	66	Phase 2 Current IEC THD
25	Total Real Power	67	Phase 2 Current TIF <sup>①</sup>
26	Phase 1 Reactive Power	68	Phase 2 Current Crest Factor <sup>①</sup>
27	Phase 2 Reactive Power	69	Phase 2 Current K-factor <sup>①</sup>
28	Phase 3 Reactive Power	70	Phase 3 Voltage IEEE THD
29	Total Reactive Power	71	Phase 3 Voltage IEC THD
30	Phase 1 Apparent Power	72	Phase 3 Voltage TIF <sup>①</sup>
31	Phase 2 Apparent Power	73	Phase 3 Voltage Crest Factor <sup>①</sup>
32	Phase 3 Apparent Power	74	Phase 3 Voltage K-factor <sup>①</sup>
33	Total Apparent Power	75	Phase 3 Current IEEE THD
34	Phase 1 True Power Factor	76	Phase 3 Current IEC THD
35	Phase 2 True Power Factor	77	Phase 3 Current TIF <sup>①</sup>
36	Phase 3 True Power Factor	78	Phase 3 Current Crest Factor <sup>①</sup>
37	Total True Power Factor	79	Phase 3 Current K-factor <sup>①</sup>
38	Phase 1 Displacement Power Factor	80	Phase 4 Current IEEE THD
39	Phase 2 Displacement Power Factor	81	Phase 4 Current IEC THD
40	Phase 3 Displacement Power Factor	82	Phase 4 Current TIF <sup>①</sup>
41	Total Displacement Power Factor	83	Phase 4 Current Crest Factor <sup>①</sup>
42	Phase 1 Distortion Power Factor	84	Phase 4 Current K-factor <sup>①</sup>

<sup>①</sup> Not available on 1403-LM.

# Allen-Bradley PLCs

**Harmonic Distortion Tables – Read**

Harmonic Distortion Data Tables for Channel 2 through Channel 7 are identical to the Even and Odd Harmonic Distortion Tables for Channel 1. There are a total of 14 tables for this information.

(V1, V2, V3, I1, I2, I3, I4) The table sizes indicate this is Harmonic Distortion Data. The Channel Number designates which one.

**Table B.17 Even Harmonic Distortion Table – Channel 1**

Parameter No.	Parameter Name	Master Module Range	Word No.	Range
13.1	IEEE Total Harmonic Distortion	0 to 1000%	1	0 to 9999
			2	10 <sup>±0</sup> to 21
13.2	IEC Total Harmonic Distortion	0 to 1000%	3	0 to 9999
			4	10 <sup>±0</sup> to 21
13.3	Meets IEEE 519 (Reserved 1403-LM)	-1 = Unknown 0 = Fail 1 = Pass	5	-1 to +1
13.4	TIF (Reserved 1403-LM)	0 to 9999x10 <sup>21</sup>	6	0 to 9999
			7	10 <sup>±0</sup> to 21
13.5	Crest Factor (Reserved 1403-LM)	0 to 9999x10 <sup>21</sup>	8	0 to 9999
			9	10 <sup>±0</sup> to 21
13.6	K-Factor (Reserved 1403-LM)	0 to 9999x10 <sup>21</sup>	10	0 to 9999
			11	10 <sup>±0</sup> to 21
13.7	Channel Number	1 = L1 Voltage 2 = L1 Current 3 = L2 Voltage 4 = L2 Current 5 = L3 Voltage 6 = L3 Current 7 = L4 Current	12	1 to 7
13.8	Harmonic Distortion – Fundamental (Reserved 1403-LM)	0 to 1000%	13	0 to 9999
			14	10 <sup>±0</sup> to 21
13.9	Harmonic Distortion – Second (Reserved 1403-LM)	0 to 1000%	15	0 to 9999
			16	10 <sup>±0</sup> to 21
13.10	Harmonic Distortion – Fourth (Reserved 1403-LM)	0 to 1000%	17	0 to 9999
			18	10 <sup>±0</sup> to 21
13.11	Harmonic Distortion – Sixth (Reserved 1403-LM)	0 to 1000%	19	0 to 9999
			20	10 <sup>±0</sup> to 21
13.12	Harmonic Distortion – Eighth (Reserved 1403-LM)	0 to 1000 %	21	0 to 9999
			22	10 <sup>±0</sup> to 21
13.13	Harmonic Distortion – Tenth (Reserved 1403-LM)	0 to 1000%	23	0 to 9999
			24	10 <sup>±0</sup> to 21
13.14	Harmonic Distortion – Twelfth (Reserved 1403-LM)	0 to 1000%	25	0 to 9999
			26	10 <sup>±0</sup> to 21
13.15	Harmonic Distortion – Fourteenth (Reserved 1403-LM)	0 to 1000%	27	0 to 9999
			28	10 <sup>±0</sup> to 21
13.16	Harmonic Distortion – Sixteenth (Reserved 1403-LM)	0 to 1000%	29	0 to 9999
			30	10 <sup>±0</sup> to 21
13.17	Harmonic Distortion – Eighteenth (Reserved 1403-LM)	0 to 1000%	31	0 to 9999
			32	10 <sup>±0</sup> to 21
13.18	Harmonic Distortion – Twentieth (Reserved 1403-LM)	0 to 1000%	33	0 to 9999
			34	10 <sup>±0</sup> to 21

Parameter No.	Parameter Name	Master Module Range	Word No.	Range
13.19	Harmonic Distortion – Twenty-second (Reserved 1403-LM)	0 to 1000%	35	0 to 9999
			36	10 <sup>±0</sup> to 21
13.20	Harmonic Distortion – Twenty-fourth (Reserved 1403-LM)	0 to 1000%	37	0 to 9999
			38	10 <sup>±0</sup> to 21
13.21	Harmonic Distortion – Twenty-sixth (Reserved 1403-LM)	0 to 1000%	39	0 to 9999
			40	10 <sup>±0</sup> to 21
13.22	Harmonic Distortion – Twenty-eighth (Reserved 1403-LM)	0 to 1000%	41	0 to 9999
			42	10 <sup>±0</sup> to 21
13.23	Harmonic Distortion – Thirtieth (Reserved 1403-LM)	0 to 1000%	43	0 to 9999
			44	10 <sup>±0</sup> to 21
13.24	Harmonic Distortion – Thirty-second (Reserved 1403-LM)	0 to 1000%	45	0 to 9999
			46	10 <sup>±0</sup> to 21
13.25	Harmonic Distortion – Thirty-fourth (Reserved 1403-LM)	0 to 1000%	47	0 to 9999
			48	10 <sup>±0</sup> to 21
13.26	Harmonic Distortion – Thirty-sixth (Reserved 1403-LM)	0 to 1000%	49	0 to 9999
			50	10 <sup>±0</sup> to 21
13.27	Harmonic Distortion – Thirty-eighth (Reserved 1403-LM)	0 to 1000%	51	0 to 9999
			52	10 <sup>±0</sup> to 21
13.28	Harmonic Distortion – Fortieth (Reserved 1403-LM)	0 to 1000%	53	0 to 9999
			54	10 <sup>±0</sup> to 21
13.29	FFT Chronological Reference Number	0 to 32767	55	0 to 32767
	Reserved Word		56	
	Reserved Word		57	
	Reserved Word		58	
	Reserved Word		59	
13.30	Data Format	0 = Integer/Exponent 1 = Floating Point	60	0 to 1

Table B.18 Odd Harmonic Distortion Table – Channel 1

Parameter No.	Parameter Name	Master Module Range	Word No.	Range
14.1	IEEE Total Harmonic Distortion	0 to 1000%	1	0 to 9999
			2	10 <sup>±0</sup> to 21
14.2	IEC Total Harmonic Distortion	0 to 1000%	3	0 to 9999
			4	10 <sup>±0</sup> to 21
14.3	Meets IEEE 519 (Reserved 1403-LM)	-1 = Unknown 0 = Fail 1 = Pass	5	-1 to +1
14.4	TIF Value (Reserved 1403-LM)	0 to 9999x10 <sup>21</sup>	6	0 to 9999
			7	10 <sup>±0</sup> to 21
14.5	Crest Factor (Reserved 1403-LM)	0 to 9999x10 <sup>21</sup>	8	0 to 9999
			9	10 <sup>±0</sup> to 21
14.6	K-Factor (Reserved 1403-LM)	0 to 9999x10 <sup>21</sup>	10	0 to 9999
			11	10 <sup>±0</sup> to 21
14.7	Channel Number	1 = L1 Voltage 2 = L1 Current 3 = L2 Voltage 4 = L2 Current 5 = L3 Voltage 6 = L3 Current 7 = L4 Current	12	1 to 7
14.8	Harmonic Distortion – Fundamental	0 to 1000%	13	0 to 9999

Parameter No.	Parameter Name	Master Module Range	Word No.	Range
	(Reserved 1403-LM)		14	$10^{\pm 0}$ to $2^1$
14.9	Harmonic Distortion – Third (Reserved 1403-LM)	0 to 1000%	15	0 to 9999
			16	$10^{\pm 0}$ to $2^1$
14.10	Harmonic Distortion – Fifth (Reserved 1403-LM)	0 to 1000%	17	0 to 9999
			18	$10^{\pm 0}$ to $2^1$
14.11	Harmonic Distortion – Seventh (Reserved 1403-LM)	0 to 1000%	19	0 to 9999
			20	$10^{\pm 0}$ to $2^1$
14.12	Harmonic Distortion – Ninth (Reserved 1403-LM)	0 to 1000%	21	0 to 9999
			22	$10^{\pm 0}$ to $2^1$
14.13	Harmonic Distortion – Eleventh (Reserved 1403-LM)	0 to 1000%	23	0 to 9999
			24	$10^{\pm 0}$ to $2^1$
14.14	Harmonic Distortion – Thirteenth (Reserved 1403-LM)	0 to 1000%	25	0 to 9999
			26	$10^{\pm 0}$ to $2^1$
14.15	Harmonic Distortion – Fifteenth (Reserved 1403-LM)	0 to 1000%	27	0 to 9999
			28	$10^{\pm 0}$ to $2^1$
14.16	Harmonic Distortion – Seventeenth (Reserved 1403-LM)	0 to 1000%	29	0 to 9999
			30	$10^{\pm 0}$ to $2^1$
14.17	Harmonic Distortion – Nineteenth (Reserved 1403-LM)	0 to 1000%	31	0 to 9999
			32	$10^{\pm 0}$ to $2^1$
14.18	Harmonic Distortion – Twenty-first (Reserved 1403-LM)	0 to 1000%	33	0 to 9999
			34	$10^{\pm 0}$ to $2^1$
14.19	Harmonic Distortion – Twenty-third (Reserved 1403-LM)	0 to 1000%	35	0 to 9999
			36	$10^{\pm 0}$ to $2^1$
14.20	Harmonic Distortion – Twenty-fifth (Reserved 1403-LM)	0 to 1000%	37	0 to 9999
			38	$10^{\pm 0}$ to $2^1$
14.21	Harmonic Distortion – Twenty-seventh (Reserved 1403-LM)	0 to 1000%	39	0 to 9999
			40	$10^{\pm 0}$ to $2^1$
14.22	Harmonic Distortion – Twenty-ninth (Reserved 1403-LM)	0 to 1000%	41	0 to 9999
			42	$10^{\pm 0}$ to $2^1$
14.23	Harmonic Distortion – Thirty-first (Reserved 1403-LM)	0 to 1000%	43	0 to 9999
			44	$10^{\pm 0}$ to $2^1$
14.24	Harmonic Distortion – Thirty-third (Reserved 1403-LM)	0 to 1000%	45	0 to 9999
			46	$10^{\pm 0}$ to $2^1$
14.25	Harmonic Distortion – Thirty-fifth (Reserved 1403-LM)	0 to 1000%	47	0 to 9999
			48	$10^{\pm 0}$ to $2^1$
14.26	Harmonic Distortion – Thirty-seventh (Reserved 1403-LM)	0 to 1000%	49	0 to 9999
			50	$10^{\pm 0}$ to $2^1$
14.27	Harmonic Distortion – Thirty-ninth (Reserved 1403-LM)	0 to 1000%	51	0 to 9999
			52	$10^{\pm 0}$ to $2^1$
14.28	Harmonic Distortion – Forty-first (Reserved 1403-LM)	0 to 1000%	53	0 to 9999
			54	$10^{\pm 0}$ to $2^1$
14.29	FFT Chronological Reference Number	0 to 32767	55	0 to 32767
	Reserved Word		56	
	Reserved Word		57	
	Reserved Word		58	
	Reserved Word		59	
	Reserved Word		60	
14.30	Data Format	0 = Integer/Exponent 1 = Floating Point	61	0 to 1

Harmonic Magnitude Data Tables for Channel 2 through Channel 7 are identical to the Even and Odd Harmonic Magnitude Tables for Channel 1. There are a total of 14 tables for this information. (V1, V2, V3, I1, I2, I3, I4)

**Table B.19 Even Harmonic Magnitude Data Table Channel 1**

Parameter No.	Parameter Name	Master Module Range	Word No.	Range
15.1	IEEE Total Harmonic Distortion	0 to 1000%	1	0 to 9999
			2	10 <sup>±0</sup> to 21
15.2	IEC Total Harmonic Distortion	0 to 1000%	3	0 to 9999
			4	10 <sup>±0</sup> to 21
15.3	Meets IEEE 519 (Reserved 1403-LM)	-1 = Unknown 0 = Fail 1 = Pass	5	-1 to +1
15.4	TIF Value (Reserved 1403-LM)	0 to 9999x10 <sup>21</sup>	6	0 to 9999
			7	10 <sup>±0</sup> to 21
15.5	Crest Factor (Reserved 1403-LM)	0 to 9999x10 <sup>21</sup>	8	0 to 9999
			9	10 <sup>±0</sup> to 21
15.6	K-Factor (Reserved 1403-LM)	0 to 9999x10 <sup>21</sup>	10	0 to 9999
			11	10 <sup>±0</sup> to 21
15.7	Channel Number	1 = L1 Voltage 2 = L1 Current 3 = L2 Voltage 4 = L2 Current 5 = L3 Voltage 6 = L3 Current 7 = L4 Current	12	1 to 7
15.8	Harmonic Magnitude – Fundamental (Reserved 1403-LM)	0 to 9999x10 <sup>21</sup>	13	0 to 9999
			14	10 <sup>±0</sup> to 21
15.9	Harmonic Magnitude – Second (Reserved 1403-LM)	0 to 9999x10 <sup>21</sup>	15	0 to 9999
			16	10 <sup>±0</sup> to 21
15.10	Harmonic Magnitude – Fourth (Reserved 1403-LM)	0 to 9999x10 <sup>21</sup>	17	0 to 9999
			18	10 <sup>±0</sup> to 21
15.11	Harmonic Magnitude – Sixth (Reserved 1403-LM)	0 to 9999x10 <sup>21</sup>	19	0 to 9999
			20	10 <sup>±0</sup> to 21
15.12	Harmonic Magnitude – Eighth (Reserved 1403-LM)	0 to 9999x10 <sup>21</sup>	21	0 to 9999
			22	10 <sup>±0</sup> to 21
15.13	Harmonic Magnitude – Tenth (Reserved 1403-LM)	0 to 9999x10 <sup>21</sup>	23	0 to 9999
			24	10 <sup>±0</sup> to 21
15.14	Harmonic Magnitude – Twelfth (Reserved 1403-LM)	0 to 9999x10 <sup>21</sup>	25	0 to 9999
			26	10 <sup>±0</sup> to 21
15.15	Harmonic Magnitude – Fourteenth (Reserved 1403-LM)	0 to 9999x10 <sup>21</sup>	27	0 to 9999
			28	10 <sup>±0</sup> to 21
15.16	Harmonic Magnitude – Sixteenth (Reserved 1403-LM)	0 to 9999x10 <sup>21</sup>	29	0 to 9999
			30	10 <sup>±0</sup> to 21
15.17	Harmonic Magnitude – Eighteenth (Reserved 1403-LM)	0 to 9999x10 <sup>21</sup>	31	0 to 9999
			32	10 <sup>±0</sup> to 21
15.18	Harmonic Magnitude – Twentieth (Reserved 1403-LM)	0 to 9999x10 <sup>21</sup>	33	0 to 9999
			34	10 <sup>±0</sup> to 21
15.19	Harmonic Magnitude – Twenty-second (Reserved 1403-LM)	0 to 9999x10 <sup>21</sup>	35	0 to 9999
			36	10 <sup>±0</sup> to 21

Allen-Bradley PLCs

Parameter No.	Parameter Name	Master Module Range	Word No.	Range
15.20	Harmonic Magnitude – Twenty-fourth (Reserved 1403-LM)	0 to 9999x10 <sup>21</sup>	37	0 to 9999
			38	10 <sup>±0</sup> to 21
15.21	Harmonic Magnitude – Twenty-sixth (Reserved 1403-LM)	0 to 9999x10 <sup>21</sup>	39	0 to 9999
			40	10 <sup>±0</sup> to 21
15.22	Harmonic Magnitude – Twenty-eighth (Reserved 1403-LM)	0 to 9999x10 <sup>21</sup>	41	0 to 9999
			42	10 <sup>±0</sup> to 21
15.23	Harmonic Magnitude – Thirtieth (Reserved 1403-LM)	0 to 9999x10 <sup>21</sup>	43	0 to 9999
			44	10 <sup>±0</sup> to 21
15.24	Harmonic Magnitude – Thirty-second (Reserved 1403-LM)	0 to 9999x10 <sup>21</sup>	45	0 to 9999
			46	10 <sup>±0</sup> to 21
15.25	Harmonic Magnitude – Thirty-fourth (Reserved 1403-LM)	0 to 9999x10 <sup>21</sup>	47	0 to 9999
			48	10 <sup>±0</sup> to 21
15.26	Harmonic Magnitude – Thirty-sixth (Reserved 1403-LM)	0 to 9999x10 <sup>21</sup>	49	0 to 9999
			50	10 <sup>±0</sup> to 21
15.27	Harmonic Magnitude – Thirty-eighth (Reserved 1403-LM)	0 to 9999x10 <sup>21</sup>	51	0 to 9999
			52	10 <sup>±0</sup> to 21
15.28	Harmonic Magnitude – Fortieth (Reserved 1403-LM)	0 to 9999x10 <sup>21</sup>	53	0 to 9999
			54	10 <sup>±0</sup> to 21
15.29	FFT Update Reference Number	0 to 32767	55	0 to 32767
	Reserved Word		56	
	Reserved Word		57	
15.30	Data Format	0 = Integer/Exponent 1 = Floating Point	58	0 to 1

Table B.20 Odd Harmonic Magnitude Data Table

Parameter No.	Parameter Name	Master Module Range	Word No.	Range
16.1	IEEE Total Harmonic Distortion	0 to 1000%	1	0 to 9999
			2	10 <sup>±0</sup> to 21
16.2	IEC Total Harmonic Distortion	0 to 1000%	3	0 to 9999
			4	10 <sup>±0</sup> to 21
16.3	Meets IEEE 519 (Reserved 1403-LM)	-1 = Unknown 0 = Fail 1 = Pass	5	-1 to +1
16.4	TIF Value (Reserved 1403-LM)	0 to 9999x10 <sup>21</sup>	6	0 to 9999
			7	10 <sup>±0</sup> to 21
16.5	Crest Factor (Reserved 1403-LM)	0 to 9999x10 <sup>21</sup>	8	0 to 9999
			9	10 <sup>±0</sup> to 21
16.6	K-Factor (Reserved 1403-LM)	0 to 9999x10 <sup>21</sup>	10	0 to 9999
			11	10 <sup>±0</sup> to 21
16.7	Channel Number	1 = L1 Voltage 2 = L1 Current 3 = L2 Voltage 4 = L2 Current 5 = L3 Voltage 6 = L3 Current 7 = L4 Current	12	1 to 7
16.8	Harmonic Magnitude – Fundamental (Reserved 1403-LM)	0 to 9999x10 <sup>21</sup>	13	0 to 9999
			14	10 <sup>±0</sup> to 21
16.9	Harmonic Magnitude – Third (Reserved 1403-LM)	0 to 9999x10 <sup>21</sup>	15	0 to 9999
			16	10 <sup>±0</sup> to 21



Parameter No.	Parameter Name	Master Module Range	Word No.	Range
16.10	Harmonic Magnitude – Fifth (Reserved 1403-LM)	0 to 9999x10 <sup>21</sup>	17	0 to 9999
			18	10 <sup>±0</sup> to 21
16.11	Harmonic Magnitude – Seventh (Reserved 1403-LM)	0 to 9999x10 <sup>21</sup>	19	0 to 9999
			20	10 <sup>±0</sup> to 21
16.12	Harmonic Magnitude – Ninth (Reserved 1403-LM)	0 to 9999x10 <sup>21</sup>	21	0 to 9999
			22	10 <sup>±0</sup> to 21
16.13	Harmonic Magnitude – Eleventh (Reserved 1403-LM)	0 to 9999x10 <sup>21</sup>	23	0 to 9999
			24	10 <sup>±0</sup> to 21
16.14	Harmonic Magnitude – Thirteenth (Reserved 1403-LM)	0 to 9999x10 <sup>21</sup>	25	0 to 9999
			26	10 <sup>±0</sup> to 21
16.15	Harmonic Magnitude – Fifteenth (Reserved 1403-LM)	0 to 9999x10 <sup>21</sup>	27	0 to 9999
			28	10 <sup>±0</sup> to 21
16.16	Harmonic Magnitude – Seventeenth (Reserved 1403-LM)	0 to 9999x10 <sup>21</sup>	29	0 to 9999
			30	10 <sup>±0</sup> to 21
16.17	Harmonic Magnitude – Nineteenth (Reserved 1403-LM)	0 to 9999x10 <sup>21</sup>	31	0 to 9999
			32	10 <sup>±0</sup> to 21
16.18	Harmonic Magnitude – Twenty-first (Reserved 1403-LM)	0 to 9999x10 <sup>21</sup>	33	0 to 9999
			34	10 <sup>±0</sup> to 21
16.19	Harmonic Magnitude – Twenty-third (Reserved 1403-LM)	0 to 9999x10 <sup>21</sup>	35	0 to 9999
			36	10 <sup>±0</sup> to 21
16.20	Harmonic Magnitude – Twenty-fifth (Reserved 1403-LM)	0 to 9999x10 <sup>21</sup>	37	0 to 9999
			38	10 <sup>±0</sup> to 21
16.21	Harmonic Magnitude – Twenty-seventh (Reserved 1403-LM)	0 to 9999x10 <sup>21</sup>	39	0 to 9999
			40	10 <sup>±0</sup> to 21
16.22	Harmonic Magnitude – Twenty-ninth (Reserved 1403-LM)	0 to 9999x10 <sup>21</sup>	41	0 to 9999
			42	10 <sup>±0</sup> to 21
16.23	Harmonic Magnitude – Thirty-first (Reserved 1403-LM)	0 to 9999x10 <sup>21</sup>	43	0 to 9999
			44	10 <sup>±0</sup> to 21
16.24	Harmonic Magnitude – Thirty-third (Reserved 1403-LM)	0 to 9999x10 <sup>21</sup>	45	0 to 9999
			46	10 <sup>±0</sup> to 21
16.25	Harmonic Magnitude – Thirty-fifth (Reserved 1403-LM)	0 to 9999x10 <sup>21</sup>	47	0 to 9999
			48	10 <sup>±0</sup> to 21
16.26	Harmonic Magnitude – Thirty-seventh (Reserved 1403-LM)	0 to 9999x10 <sup>21</sup>	49	0 to 9999
			50	10 <sup>±0</sup> to 21
16.27	Harmonic Magnitude – Thirty-ninth (Reserved 1403-LM)	0 to 9999x10 <sup>21</sup>	51	0 to 9999
			52	10 <sup>±0</sup> to 21
16.28	Harmonic Magnitude – Forty-first (Reserved 1403-LM)	0 to 9999x10 <sup>21</sup>	53	0 to 9999
			54	10 <sup>±0</sup> to 21
16.29	FFT Chronological Reference Number	0 to 32767	55	0 to 32767
	Reserved Word		56	
16.30	Data Format	0 = Integer/Exponent 1 = Floating Point	57	0 to 1

Harmonic Phase Angle Data Tables for Channel 2 through Channel 7 are identical to the Even and Odd Harmonic Phase Angle Data Tables for Channel 1. There are a total of 14 tables for this information.  
(V1, V2, V3, I1, I2, I3, I4)

**Table B.21 Even Harmonic Phase Angle Data Table Channel 1**

Parameter No.	Parameter Name	Master Module Range	Word No.	Range
	Reserved Word		1	0 to 9999
	Reserved Word		2	$10^{\pm 0}$ to 21
	Reserved Word		3	0 to 9999
	Reserved Word		4	$10^{\pm 0}$ to 21
	Reserved Word		5	0 -1
	Reserved Word		6	0 to 9999
	Reserved Word		7	$10^{\pm 0}$ to 21
	Reserved Word		8	0 to 9999
	Reserved Word		9	$10^{\pm 0}$ to 21
	Reserved Word		10	0 to 9999
	Reserved Word		11	$10^{\pm 0}$ to 21
17.7	Channel Number (Reserved 1403-LM)	1 = L1 Voltage 2 = L1 Current 3 = L2 Voltage 4 = L2 Current 5 = L3 Voltage 6 = L3 Current 7 = L4 Current	12	1 to 7
17.8	Harmonic Phase Angle – Fundamental (Reserved 1403-LM)	0 to 360 degrees	13	0 to 9999
			14	$10^{\pm 0}$ to 21
17.9	Harmonic Phase Angle – Second (Reserved 1403-LM)	0 to 360 degrees	15	0 to 9999
			16	$10^{\pm 0}$ to 21
17.10	Harmonic Phase Angle – Fourth (Reserved 1403-LM)	0 to 360 degrees	17	0 to 9999
			18	$10^{\pm 0}$ to 21
17.11	Harmonic Phase Angle – Sixth (Reserved 1403-LM)	0 to 360 degrees	19	0 to 9999
			20	$10^{\pm 0}$ to 21
17.12	Harmonic Phase Angle – Eighth (Reserved 1403-LM)	0 to 360 degrees	21	0 to 9999
			22	$10^{\pm 0}$ to 21
17.13	Harmonic Phase Angle – Tenth (Reserved 1403-LM)	0 to 360 degrees	23	0 to 9999
			24	$10^{\pm 0}$ to 21
17.14	Harmonic Phase Angle – Twelfth (Reserved 1403-LM)	0 to 360 degrees	25	0 to 9999
			26	$10^{\pm 0}$ to 21
17.15	Harmonic Phase Angle – Fourteenth (Reserved 1403-LM)	0 to 360 degrees	27	0 to 9999
			28	$10^{\pm 0}$ to 21
17.16	Harmonic Phase Angle – Sixteenth (Reserved 1403-LM)	0 to 360 degrees	29	0 to 9999
			30	$10^{\pm 0}$ to 21
17.17	Harmonic Phase Angle – Eighteenth (Reserved 1403-LM)	0 to 360 degrees	31	0 to 9999
			32	$10^{\pm 0}$ to 21
17.18	Harmonic Phase Angle – Twentieth (Reserved 1403-LM)	0 to 360 degrees	33	0 to 9999
			34	$10^{\pm 0}$ to 21
17.19	Harmonic Phase Angle – Twenty-second (Reserved 1403-LM)	0 to 360 degrees	35	0 to 9999
			36	$10^{\pm 0}$ to 21
17.20	Harmonic Phase Angle – Twenty-fourth (Reserved 1403-LM)	0 to 360 degrees	37	0 to 9999
			38	$10^{\pm 0}$ to 21

Parameter No.	Parameter Name	Master Module Range	Word No.	Range
17.21	Harmonic Phase Angle – Twenty-sixth (Reserved 1403-LM)	0 to 360 degrees	39	0 to 9999
			40	10 <sup>±0</sup> to 21
17.22	Harmonic Phase Angle – Twenty-eighth (Reserved 1403-LM)	0 to 360 degrees	41	0 to 9999
			42	10 <sup>±0</sup> to 21
17.23	Harmonic Phase Angle – Thirtieth (Reserved 1403-LM)	0 to 360 degrees	43	0 to 9999
			44	10 <sup>±0</sup> to 21
17.24	Harmonic Phase Angle – Thirty-second (Reserved 1403-LM)	0 to 360 degrees	45	0 to 9999
			46	10 <sup>±0</sup> to 21
17.25	Harmonic Phase Angle – Thirty-fourth (Reserved 1403-LM)	0 to 360 degrees	47	0 to 9999
			48	10 <sup>±0</sup> to 21
17.26	Harmonic Phase Angle – Thirty-sixth (Reserved 1403-LM)	0 to 360 degrees	49	0 to 9999
			50	10 <sup>±0</sup> to 21
17.27	Harmonic Phase Angle – Thirty-eighth (Reserved 1403-LM)	0 to 360 degrees	51	0 to 9999
			52	10 <sup>±0</sup> to 21
17.28	Harmonic Phase Angle – Fortieth (Reserved 1403-LM)	0 to 360 degrees	53	0 to 9999
			54	10 <sup>±0</sup> to 21
17.29	FFT Chronological Reference Number	0 to 32767	55	0 to 32767
17.30	Data Format	0 = Integer/Exponent 1 = Floating Point	56	0 to 1

Table B.22 Odd Harmonic Phase Angle Data Table

Parameter No.	Parameter Name	Master Module Range	Word No.	Range
	Reserved Word		1	0 to 9999
	Reserved Word		2	10 <sup>±0</sup> to 21
	Reserved Word		3	0 to 9999
	Reserved Word		4	10 <sup>±0</sup> to 21
	Reserved Word		5	0 – 1
	Reserved Word		6	0 to 9999
	Reserved Word		7	10 <sup>±0</sup> to 21
	Reserved Word		8	0 to 9999
	Reserved Word		9	10 <sup>±0</sup> to 21
	Reserved Word		10	0 to 9999
	Reserved Word		11	10 <sup>±0</sup> to 21
18.7	Channel Number (Reserved 1403-LM)	1 = L1 Voltage 2 = L1 Current 3 = L2 Voltage 4 = L2 Current 5 = L3 Voltage 6 = L3 Current 7 = L4 Current	12	1 to 7
18.8	Harmonic Phase Angle – Fundamental (Reserved 1403-LM)	0 to 360 degrees	13	0 to 9999
			14	10 <sup>±0</sup> to 21
18.9	Harmonic Phase Angle – Third (Reserved 1403-LM)	0 to 360 degrees	15	0 to 9999
			16	10 <sup>±0</sup> to 21
18.10	Harmonic Phase Angle – Fifth (Reserved 1403-LM)	0 to 360 degrees	17	0 to 9999
			18	10 <sup>±0</sup> to 21
18.11	Harmonic Phase Angle – Seventh (Reserved 1403-LM)	0 to 360 degrees	19	0 to 9999
			20	10 <sup>±0</sup> to 21
18.12	Harmonic Phase Angle – Ninth	0 to 360 degrees	21	0 to 9999

Parameter No.	Parameter Name	Master Module Range	Word No.	Range
	(Reserved 1403-LM)		22	$10^{\pm 0}$ to 21
18.13	Harmonic Phase Angle – Eleventh (Reserved 1403-LM)	0 to 360 degrees	23	0 to 9999
			24	$10^{\pm 0}$ to 21
18.14	Harmonic Phase Angle – Thirteenth (Reserved 1403-LM)	0 to 360 degrees	25	0 to 9999
			26	$10^{\pm 0}$ to 21
18.15	Harmonic Phase Angle – Fifteenth (Reserved 1403-LM)	0 to 360 degrees	27	0 to 9999
			28	$10^{\pm 0}$ to 21
18.16	Harmonic Phase Angle – Seventeenth (Reserved 1403-LM)	0 to 360 degrees	29	0 to 9999
			30	$10^{\pm 0}$ to 21
18.17	Harmonic Phase Angle – Nineteenth (Reserved 1403-LM)	0 to 360 degrees	31	0 to 9999
			32	$10^{\pm 0}$ to 21
18.18	Harmonic Phase Angle – Twenty-first (Reserved 1403-LM)	0 to 360 degrees	33	0 to 9999
			34	$10^{\pm 0}$ to 21
18.19	Harmonic Phase Angle – Twenty-third (Reserved 1403-LM)	0 to 360 degrees	35	0 to 9999
			36	$10^{\pm 0}$ to 21
18.20	Harmonic Phase Angle – Twenty-fifth (Reserved 1403-LM)	0 to 360 degrees	37	0 to 9999
			38	$10^{\pm 0}$ to 21
18.21	Harmonic Phase Angle – Twenty-seventh (Reserved 1403-LM)	0 to 360 degrees	39	0 to 9999
			40	$10^{\pm 0}$ to 21
18.22	Harmonic Phase Angle – Twenty-ninth (Reserved 1403-LM)	0 to 360 degrees	41	0 to 9999
			42	$10^{\pm 0}$ to 21
18.23	Harmonic Phase Angle – Thirty-first (Reserved 1403-LM)	0 to 360 degrees	43	0 to 9999
			44	$10^{\pm 0}$ to 21
18.24	Harmonic Phase Angle – Thirty-third (Reserved 1403-LM)	0 to 360 degrees	45	0 to 9999
			46	$10^{\pm 0}$ to 21
18.25	Harmonic Phase Angle – Thirty-fifth (Reserved 1403-LM)	0 to 360 degrees	47	0 to 9999
			48	$10^{\pm 0}$ to 21
18.26	Harmonic Phase Angle – Thirty-seventh (Reserved 1403-LM)	0 to 360 degrees	49	0 to 9999
			50	$10^{\pm 0}$ to 21
18.27	Harmonic Phase Angle – Thirty-ninth (Reserved 1403-LM)	0 to 360 degrees	51	0 to 9999
			52	$10^{\pm 0}$ to 21
18.28	Harmonic Phase Angle – Forty-first (Reserved 1403-LM)	0 to 360 degrees	53	0 to 9999
			54	$10^{\pm 0}$ to 21
18.29	FFT Chronological Reference Number	0 to 32767	55	0 to 32767

**Table B.23 Oscilloscope Capture Data – Read (54 Reads of 48 data points for 2-channel 12-cycle oscilloscope or 9 Reads of 48 data points for 7-channel 2-cycle oscilloscope)**

Parameter No.	Parameter Name	Master Module Range	Word No.	Range
19.1	Time Stamp of Oscilloscope  (Reserved 1403-LM)	Year	1	0-99 16 Bit Integer
		Month, Date	2	1-12 8 Bit    1-31 8 Bit
		Hour, Minute	3	0-23 8 Bit    0-59 8 Bit
		Seconds, Hundredths	4	0-59 8 Bit    0-99 8 Bit
19.2	Channel Number (Reserved 1403-LM)	1 = L1 Voltage 2 = L1 Current 3 = L2 Voltage 4 = L2 Current 5 = L3 Voltage 6 = L3 Current 7 = L4 Current 8 = Ch A 12-Cycle 9 = Ch B 12-Cycle	5	1 to 9
19.3	Channel Data Count (Reserved 1403-LM)	for 2-cycle 432 for 12-cycle 2592	6	432 or 2592
19.4	Oscilloscope Chronological Reference Number (Reserved 1403-LM)	0 to +32767	7	0 to 32767
19.5	Oscilloscope Block Number (Reserved 1403-LM)	1 to 54	8	1 to 54
19.6	Actual Channel Number (Reserved 1403-LM)	1 = L1 Voltage 2 = L1 Current 3 = L2 Voltage 4 = L2 Current 5 = L3 Voltage 6 = L3 Current 7 = L4 Current	9	1 to 7
19.7	Oscilloscope Data Point 1 (Reserved 1403-LM)	±5000	10	±5000
19.8	Oscilloscope Data Point 2 (Reserved 1403-LM)	±5000	11	±5000
19.9	Oscilloscope Data Point 3 (Reserved 1403-LM)	±5000	12	±5000
19.10	Oscilloscope Data Point 4 (Reserved 1403-LM)	±5000	13	±5000
19.11	Oscilloscope Data Point 5 (Reserved 1403-LM)	±5000	14	±5000
19.12	Oscilloscope Data Point 6 (Reserved 1403-LM)	±5000	15	±5000
19.13	Oscilloscope Data Point 7 (Reserved 1403-LM)	±5000	16	±5000
19.14	Oscilloscope Data Point 8 (Reserved 1403-LM)	±5000	17	±5000
19.15	Oscilloscope Data Point 9 (Reserved 1403-LM)	±5000	18	±5000
19.16	Oscilloscope Data Point 10 (Reserved 1403-LM)	±5000	19	±5000
19.17	Oscilloscope Data Point 11 (Reserved 1403-LM)	±5000	20	±5000
19.18	Oscilloscope Data Point 12 (Reserved 1403-LM)	±5000	21	±5000
19.19	Oscilloscope Data Point 13 (Reserved 1403-LM)	±5000	22	±5000
19.20	Oscilloscope Data Point 14 (Reserved 1403-LM)	±5000	23	±5000
19.21	Oscilloscope Data Point 15 (Reserved 1403-LM)	±5000	24	±5000
19.22	Oscilloscope Data Point 16 (Reserved 1403-LM)	±5000	25	±5000
19.23	Oscilloscope Data Point 17 (Reserved 1403-LM)	±5000	26	±5000
19.24	Oscilloscope Data Point 18 (Reserved 1403-LM)	±5000	27	±5000
19.25	Oscilloscope Data Point 19 (Reserved 1403-LM)	±5000	28	±5000
19.26	Oscilloscope Data Point 20 (Reserved 1403-LM)	±5000	29	±5000
19.27	Oscilloscope Data Point 21 (Reserved 1403-LM)	±5000	30	±5000

Parameter No.	Parameter Name	Master Module Range	Word No.	Range
19.28	Oscillogram Data Point 22 (Reserved 1403-LM)	±5000	31	±5000
19.29	Oscillogram Data Point 23 (Reserved 1403-LM)	±5000	32	±5000
19.30	Oscillogram Data Point 24 (Reserved 1403-LM)	±5000	33	±5000
19.31	Oscillogram Data Point 25 (Reserved 1403-LM)	±5000	34	±5000
19.32	Oscillogram Data Point 26 (Reserved 1403-LM)	±5000	35	±5000
19.33	Oscillogram Data Point 27 (Reserved 1403-LM)	±5000	36	±5000
19.34	Oscillogram Data Point 28 (Reserved 1403-LM)	±5000	37	±5000
19.35	Oscillogram Data Point 29 (Reserved 1403-LM)	±5000	38	±5000
19.36	Oscillogram Data Point 30 (Reserved 1403-LM)	±5000	39	±5000
19.37	Oscillogram Data Point 31 (Reserved 1403-LM)	±5000	40	±5000
19.38	Oscillogram Data Point 32 (Reserved 1403-LM)	±5000	41	±5000
19.39	Oscillogram Data Point 33 (Reserved 1403-LM)	±5000	42	±5000
19.40	Oscillogram Data Point 34 (Reserved 1403-LM)	±5000	43	±5000
19.41	Oscillogram Data Point 35 (Reserved 1403-LM)	±5000	44	±5000
19.42	Oscillogram Data Point 36 (Reserved 1403-LM)	±5000	45	±5000
19.43	Oscillogram Data Point 37 (Reserved 1403-LM)	±5000	46	±5000
19.44	Oscillogram Data Point 38 (Reserved 1403-LM)	±5000	47	±5000
19.45	Oscillogram Data Point 39 (Reserved 1403-LM)	±5000	48	±5000
19.46	Oscillogram Data Point 40 (Reserved 1403-LM)	±5000	49	±5000
19.47	Oscillogram Data Point 41 (Reserved 1403-LM)	±5000	50	±5000
19.48	Oscillogram Data Point 42 (Reserved 1403-LM)	±5000	51	±5000
19.49	Oscillogram Data Point 43 (Reserved 1403-LM)	±5000	52	±5000
19.50	Oscillogram Data Point 44 (Reserved 1403-LM)	±5000	53	±5000
19.51	Oscillogram Data Point 45 (Reserved 1403-LM)	±5000	54	±5000
19.52	Oscillogram Data Point 46 (Reserved 1403-LM)	±5000	55	±5000
19.53	Oscillogram Data Point 47 (Reserved 1403-LM)	±5000	56	±5000
19.54	Oscillogram Data Point 48 (Reserved 1403-LM)	±5000	57	±5000
	Reserved Word		58	
	Reserved Word		59	
	Reserved Word		60	
	Reserved Word		61	
	Reserved Word		62	
	Reserved Word		63	

For PT Secondary Values < 138 **Max Voltage** = 138.0

For PT Secondary Values ≥ 138 **Max Voltage** = 399.0

For MM01A or MM01B **Max Current** = 1.42

For MM05A or MM05B **Max Current** = 7.10

**Max Counts** = 4095

$$\frac{(\text{Max Voltage or Max Current} \times \sqrt{2})}{\text{Max Counts}} \times \frac{\text{PT or CT Primary}}{\text{PT or CT Secondary}} \times \text{Oscillogram Data Point} \approx \text{Voltage or Current}$$

Table B.24 Diagnostic Data Table (Self-test Results) Read

Parameter No.	Parameter Name	Master Module Range	Word No.	Range
20.1	Time Stamp of Diagnostic Data	Year	1	0-99 16 Bit Integer
		Month, Date	2	1-12 8 Bit   1-31 8 Bit
		Hour, Minute	3	0-23 8 Bit   0-59 8 Bit
		Seconds, Hundredths	4	0-59 8 Bit   0-99 8 Bit
20.2	Bulletin Number	1403	5	1403
20.3	Master Module FRN	0 to 32767	6	0 to 32767
20.4	Options Bit Field		7	16 Bit Integer
20.5	Summary Status		8	16 Bit Integer
20.6	Master Module ROM Status		9	16 Bit Integer
20.7	Master Module RAM Status		10	16 Bit Integer
20.8	NV RAM Status		11	16 Bit Integer
20.9	Power Supply Check		12	16 Bit Integer
20.10	Data Acquisition		13	16 Bit Integer
20.11	Master Module Watchdog Timer		14	16 Bit Integer
20.12	Real Time Clock Status		15	16 Bit Integer
20.13	Reserved		16	
20.14	Reserved		17	
20.15	Battery Usage	0 to 32767	18	0 to 32767
20.16	Smart Communication Card Status		19	16 Bit Integer
20.17	Reserved		20	
20.18	Smart Communication Card Type	0 = none 1 = 1403-NSC	21	0 to 32767
20.19	Smart Communication Card FRN	0 to 32767	22	0 to 32767
20.20	Number of Display Modules	0 to 3	23	0 to 3
20.21	Display Module Status		24	16 Bit Integer
20.22	Display Module Self Test Results Word 1		25	16 Bit Integer
20.23	Display Module Self Test Results Word 2		26	16 Bit Integer
20.24	Display Module No. 1 FRN	0 to 32767	27	0 to 32767
20.25	Display Module No. 2 FRN	0 to 32767	28	0 to 32767
20.26	Display Module No. 3 FRN	0 to 32767	29	0 to 32767
20.27	Auxiliary Frequency	0 to 9999x10 <sup>21</sup>	30	0 to 9999
			31	0 to 32
20.28	Fiber Loop Back Test Results	0 = Fail 1 = Pass	32	0 to 1
20.29	EEPROM Status		33	16 Bit Integer
20.30	Device ID	0 to 255	34	0 to 255
20.31	General Purpose Status Bits	bit 0 = oscillogram captured bit 1 = snapshot buffer full bit 2 = oscillogram triggered by a setpoint	35	0 to 7
20.32	Block Write Error Status Word (Block Size ID)	0 = OK Other value = Error	36	0 to 64
20.33	Block Write Error Status Word (Parameter Number)	0 = OK Other value = Error	37	0 to 32767
20.34	Reserved Word		38	
20.35	Reserved Word		39	

Allen-Bradley PLCs

Table B.25 Setpoint Setup Data Table – Write/Read

Parameter No.	Parameter Name	Master Module Range	Word No.	Range
21.1	Setpoint Number	1 to 20	1	1 to 20
21.2	Setpoint Type	0 to 54 (see Table B.26 in Publication 1403-5.1)	2	0 to 54
21.3	Setpoint Evaluation Condition	Over Forward = 0 Over Reverse = 1 Under Forward = 2 Under Reverse = 3 Equal = 4 Not Equal = 5	3	0 to 5
21.4	Setpoint High Limit	0.0 to 1,000,000.0	4	0 to 9999
			5	10 <sup>±0</sup> to 21
21.5	Setpoint Low Limit	0.0 to 1,000,000.0	6	0 to 9999
			7	10 <sup>±0</sup> to 21
21.6	Setpoint Action Delay	0 to 9999	8	0 to 9999
21.7	Setpoint Release Delay	0 to 9999	9	0 to 9999
21.8	Setpoint Action Type	0 to 20 (see Table B.26 in Publication 1403-5.1)	10	0 to 20
21.9	Present Unit Password	0 to 9999 Default = 0	11	0 to 9999
	Reserved Word		12	
	Reserved Word		13	
	Reserved Word		14	
	Reserved Word		15	
	Reserved Word		16	
	Reserved Word		17	
	Reserved Word		18	
	Reserved Word		19	
21.10	Data Format	0 = Integer/Exponent 1 = Floating Point	20	0 to 1



Table B.26 Setpoint Type

Setpoint Type Name	Value
Not Used (Inactive)	0
Voltage	1
Current	2
Voltage Unbalance	3
Current Unbalance	4
Vaux Voltage	5
Neutral (I4) Current	6
kW	7
kVAR	8
kVA	9
Total True Power Factor	10
Total Displacement Power Factor	11
Total Distortion Power Factor	12
kW Demand	13
kVAR Demand	14
kVA Demand	15
Current Demand	16
Type 1 Predictive Demand A	17
Type 1 Predictive Demand W	18
Type 1 Predictive Demand VAR	19
Type 1 Predictive Demand VA	20
Type 2 Predictive Demand A	21
Type 2 Predictive Demand W	22
Type 2 Predictive Demand VAR	23
Type 2 Predictive Demand VA	24
Type 3 Predictive Demand A	25
Type 3 Predictive Demand W	26
Type 3 Predictive Demand VAR	27
Type 3 Predictive Demand VA	28
Frequency	29
Phase Rotation	30
K-Factor: Voltage <sup>①</sup>	31
K-Factor: Current <sup>①</sup>	32

<sup>①</sup> Not Available For 1403-LM

Setpoint Type Name	Value
K-Factor: Neutral Current <sup>①</sup>	33
Crest Factor: Voltage <sup>①</sup>	34
Crest Factor: Current <sup>①</sup>	35
Crest Factor: Neutral Current <sup>①</sup>	36
TIF: Voltage <sup>①</sup>	37
TIF: Current <sup>①</sup>	38
TIF: Neutral Current <sup>①</sup>	39
IEEE THD: Voltage	40
IEEE THD: Current	41
IEEE THD: Neutral Current	42
IEC THD: Voltage	43
IEC THD: Current	44
IEC THD: Neutral Current	45
IEEE519: Voltage <sup>①</sup>	46
IEEE519: Current <sup>①</sup>	47
IEEE519: Neutral Current <sup>①</sup>	48
Status Input No. 1	49
Status Input No. 2	50
Status Input No. 3	51
Status Input No. 4	52
Any Status Input	53
Battery Usage Timer	54

Table B.27 Setpoint Action

Setpoint Action	Value
No Action	0
Activate Relay No. 1 and Output Flag No. 1	1
Activate Relay No. 2 and Output Flag No. 2	2
Activate Output Flag No. 3	3
Activate Output Flag No. 4	4
Activate Output Flag No. 5	5
Activate Output Flag No. 6	6
Activate Output Flag No. 7	7
Activate Output Flag No. 8	8
Activate Output Flag No. 9	9
Activate Output Flag No. 10	10
Activate Output Flag No. 11	11
Activate Output Flag No. 12	12
Activate Output Flag No. 13	13
Activate Output Flag No. 14	14
Activate Output Flag No. 15	15
Activate Output Flag No. 16	16
Initiate Waveform Capture <sup>①</sup>	17
Perform Snapshot	18
Clear kW-HR Power Counter	19
Clear kVAR-HR Power Counter	20

Table B.28 Relay/Setpoint Status Table Read

Parameter No.	Parameter Name	Master Module Range	Word No.	Range
22.1	Time Stamp	Year	1	0-99 16 Bit Integer
		Month, Date	2	1-12 8 Bit    1-31 8 Bit
		Hour, Minute	3	0-23 8 Bit    0-59 8 Bit
		Seconds, Hundredths	4	0-59 8 Bit    0-99 8 Bit
22.2	Relay No. 1 Status (Bit Fields)	0 = De-energized 1 = Energized 2 = Forced De-energized 3 = Forced Energized	5	0 to 3
22.3	Relay No. 2 Status (Bit Fields)	0 = De-energized 1 = Energized 2 = Forced De-energized 3 = Forced Energized	6	0 to 3
22.4	Alarm Word		7	16 Bit Integer
22.5	Status Inputs (Bit Fields)		8	16 Bit Integer
22.6	Counter Status Input No. 1	-32767 to 32767	9	-32767 to 32767
22.7	Counter Status Input No. 2	-32767 to 32767	10	-32767 to 32767
22.8	Counter Status Input No. 3	-32767 to 32767	11	-32767 to 32767
22.9	Counter Status Input No. 4	-32767 to 32767	12	-32767 to 32767
22.10	Setpoint No. 1 Status (Bit Fields)		13	16 Bit Integer
22.11	Setpoint No. 2 Status (Bit Fields)		14	16 Bit Integer
22.12	Setpoint No. 3 Status (Bit Fields)		15	16 Bit Integer
22.13	Setpoint No. 4 Status (Bit Fields)		16	16 Bit Integer
22.14	Setpoint No. 5 Status (Bit Fields)		17	16 Bit Integer
22.15	Setpoint No. 6 Status (Bit Fields)		18	16 Bit Integer
22.16	Setpoint No. 7 Status (Bit Fields)		19	16 Bit Integer
22.17	Setpoint No. 8 Status (Bit Fields)		20	16 Bit Integer
22.18	Setpoint No. 9 Status (Bit Fields)		21	16 Bit Integer
22.19	Setpoint No. 10 Status (Bit Fields)		22	16 Bit Integer
22.20	Setpoint No. 11 Status (Bit Fields)		23	16 Bit Integer
22.21	Setpoint No. 12 Status (Bit Fields)		24	16 Bit Integer
22.22	Setpoint No. 13 Status (Bit Fields)		25	16 Bit Integer
22.23	Setpoint No. 14 Status (Bit Fields)		26	16 Bit Integer
22.24	Setpoint No. 15 Status (Bit Fields)		27	16 Bit Integer
22.25	Setpoint No. 16 Status (Bit Fields)		28	16 Bit Integer
22.26	Setpoint No. 17 Status (Bit Fields)		29	16 Bit Integer
22.27	Setpoint No. 18 Status (Bit Fields)		30	16 Bit Integer
22.28	Setpoint No. 19 Status (Bit Fields)		31	16 Bit Integer
22.29	Setpoint No. 20 Status (Bit Fields)		32	16 Bit Integer
	Reserved Word		33	
	Reserved Word		34	
	Reserved Word		35	
	Reserved Word		36	
	Reserved Word		37	
	Reserved Word		38	

Table B.29 Status Inputs Bitfield Definitions

Bit Location and Value	Description
b0 = 1	Status Input 1 Active
b1 = 1	Status Input 2 Active
b2 = 1	Status Input 3 Active
b3 = 1	Status Input 4 Active
b4 to b15	Reserved

Table B.30 Alarm word Bitfield Definitions

Bit Location and Value	Description
b0 = 1	Alarm Input 1 Active
b1 = 1	Alarm Input 2 Active
b2 = 1	Alarm Input 3 Active
b3 = 1	Alarm Input 4 Active
b4 = 1	Alarm Input 5 Active
b5 = 1	Alarm Input 6 Active
b6 = 1	Alarm Input 7 Active
b7 = 1	Alarm Input 8 Active
b8 = 1	Alarm Input 9 Active
b9 = 1	Alarm Input 10 Active
b10 = 1	Alarm Input 11 Active
b11 = 1	Alarm Input 12 Active
b12 = 1	Alarm Input 13 Active
b13 = 1	Alarm Input 14 Active
b14 = 1	Alarm Input 15 Active
b15 = 1	Alarm Input 16 Active

Table B.31 Setpoint Status Bitfield Definitions

Bit Location and Value	Description
b0 to b7	Setpoint Assert Counter
b8 = not used	Reserved
b9 = 1	Waiting for Release
b10 = 1	Limit Met for Release
b11 = 1	Setpoint Asserted
b12 = 1	Waiting for Assert
b13 = 1	Limit Met for Assert
b14 = 1	Setpoint Released
b15 = 1	Setpoint Active



## Serial Communication Protocol Tutorial

The Smart Communication Card supports the DF1 link layer protocol

For additional information regarding the DF1 link layer protocol, refer to the *Data Highway/Data Highway Plus™/DH-485 Communication Protocol and Command Set*, Allen-Bradley Publication 1770-6.5.16 (November 1991).

Table C.1 contains definitions of single byte codes.

**Table C.1 Special Byte Codes**

Symbol	Value
SOH	0x01
STX	0x02
ETX	0x03
EOT	0x04
ENQ	0x05
ACK	0x06
DLE	0x10
NAK	0x15
DST	Address of destination Powermonitor II
SRC	Address of master (device that is sending this request)
BCC	8 bit block check character. (For Powermonitor II used only in poll command where it is equal to the 2's compliment of the STN value)
CRC	16 bit CRC calculated as described in the CRC16 section below.
STN	Data symbol. Station number of the slave node on your half-duplex link.

Table C.2 contains definitions of multiple byte codes.

**Table C.2 Special Symbol Meanings**

Symbol	Type	Meaning
DLE SOH	Control symbol	Sender symbol that indicates the start of a master message.
DLE STX	Control symbol	Sender symbol that separates the multi-drop header from the data.
DLE ETX BCC/CRC	Control symbol	Sender symbol that terminates a message.
DLE ACK	Control symbol	Response symbol which signals that a message has been successfully received.
DLE NAK	Control symbol	Global link reset command only issued by the master. Causes the slaves to cancel all messages that are ready to transmit to the master. Typically, the slave returns the message and an error code to the originator.
DLE ENQ		Sender symbol, issued only by the master, that starts a poll command.
DLE EOT	Control symbol	Response symbol used by slaves as a response to a poll when they have no messages to send. (Only sent by Powermonitor II if a poll command is sent that was not preceded by a read request command.)
APP DATA	Data symbol	Single characters having hex values 00-0F and 11-FF (i.e., 00-FF not including 0x10). Includes data from application layer including user programs and common application routines.
DLE DLE	Data symbol	Represents the data value or STN value of 0x10.

## Generic Packet Construction

### Polling Packet

[ DLE / ENQ / STN / BCC ]

### Slave Message Link Packet

[ DLE / STX / APP\_DATA / DLE / ETX / CRC ]

APP\_DATA = [ DST / SRC / CMD / STS / TNS / TNS /  
Response\_Data ]

#### Read

Response\_Data = [ 1st\_dataword\_lo / 1st\_dataword\_hi /  
... / last\_dataword\_lo / last\_dataword\_hi ]

#### Write

Response\_Data = [ Ext Status (if error) ]

### Master Message Link Packet

[ DLE / SOH / STN / DLE / STX / APP\_DATA / DLE /  
ETX / CRC ]

APP\_DATA = [ DST / SRC / CMD / STS / TNS / TNS /  
Command\_Block ]

#### Read

Command\_Block = [ FNC\_byte / Byte\_size /  
File\_number / File\_type / Element\_number /  
Sub-element\_number ]

FNC\_byte = 0xA2

byte\_size = size/ID of data table being requested in bytes  
(words X 2)

file\_number = 0x00

file\_type = 0x89

element\_number = 0x00

sub-element\_number = 0x00

#### Write

Command\_Block = [ FNC\_byte / Byte\_size /  
File\_number / File\_type / Element\_number /  
Sub-element\_number / 1st\_dataword\_lo /  
1st\_dataword\_hi / ... / last\_dataword\_lo /  
last\_dataword\_hi ]

FNC\_byte = 0xAA

byte\_size = size/ID of data table being requested in bytes  
(words X 2)

file\_number = 0x00

file\_type = 0x89

element\_number = 0x00

sub-element\_number = 0x00

Table C.3 Write Sequence

Transmitted from Serial Network Master	Description/ Direction	Transmitted from Smart Communication Card
[ DLE / SOH / STN / DLE / STX / DST / SRC / 0x0F / 0x00 / 0x00 / 0x00 / 0xAA / data_size / 0x00 / 0x89 / 0x00 / 0x00 / 1st_dataword_lo / 1st_dataword_hi /.../ last_dataword_lo / last_dataword_hi / DLE / ETX / CRC ]	Write Data →	
	DF1 Ack ←	[ DLE / ACK ]
[ DLE / ENQ / STN / BCC ]  (Note: should wait for application ack, time-out, and repeat poll until data is received)	Poll →	
	Application Ack ←	[ DLE / STX / DST / SRC / 0x4F / STS / TNS / TNS / Ext_STS (if error) / DLE / ETX / CRC ]
[ DLE / ACK ]	DF1 Ack →	

Table C.4 Read Sequence

Transmitted from Serial Network Master	Description/ Direction	Transmitted from Smart Communication Card
[ DLE / SOH / STN / DLE / STX / DST / SRC / 0x0F / 0x00 / 0x00 / 0x00 / 0xA2 / data_size / 0x00 / 0x89 / 0x00 / 0x00 / DLE / ETX / CRC ]	Read Request →	
	DF1 Ack ←	[ DLE / ACK ]
[ DLE / ENQ / STN / BCC ]  (Note: should wait for data, time-out, and repeat poll until data is received)	Poll →	
	Data ←	[ DLE / STX / DST / SRC / 0x4F / STS / TNS / TNS / 1st_dataword_lo / 1st_dataword_hi /.../ last_dataword_lo / last_dataword_hi / DLE / ETX / CRC ]
[ DLE / ACK ]	DF1 Ack →	

## CRC16 (Cyclic Redundancy Check)

The 16-bit cyclic redundancy check (CRC16) is a method to check the integrity of a message packet. CRC16 provides a higher level of data security than block check character.

Calculate the CRC value for master messages using the value of the STN, STX, data bytes, and the ETX (do not add in the associated DLE for STX and ETX). Calculate the CRC value for slave messages the same way, except **DO NOT** include the STX byte in the CRC calculation.

**Important:** To transmit the STN or data value of 10 hex, you must use the data symbol DLE DLE. However, only one of these DLE data bytes is included in the CRC value.

At the start of a message packet, the transmitter clears a 16-bit register for the CRC value. As the first byte is transmitted, it is Exclusive-Or'ed (least significant bit to the right) with the right eight bits of the CRC register. The result is placed back into the right eight bits of the CRC register.

```

data_byte = STN, STX, all application layer data, ETX
CLEAR CRC_REGISTER
For each data_byte
  Get data_byte
  XOR (data_byte, right 8 bits of CRC_REGISTER)
  PLACE RESULT in right 8 bits of CRC_REGISTER
  DO 8 times
    Shift bit right, shift in 0 at left
    IF bit shifted = 1
      XOR (CONSTANT, CRC_REGISTER)
      PLACE RESULT in CRC_REGISTER
    END IF
  END DO
END FOR
TRANSMIT CRC_REGISTER as 2 byte CRC field

```

### Examples

Example Destination Address = 123 (0x78)

Example Source Address = 0 (0x00)

The CRC register is then shifted right eight times by inserting 0x on the left. Each time a 1 is shifted out on the right, the CRC register is Exclusive-OR'ed with the following 16-bit binary constant:

CONSTANT = 1010 0000 0000 0001

The result is placed back into the CRC register. After this shifting is completed, you are ready to transmit the next byte.

As each additional byte is transmitted, it is included in the value in the CRC register the same way. After the ETX value is included in the value in the register and is transmitted, the value in the CRC register is transmitted (right bit first) as the CRC field.

The receiver also calculates the CRC value and compares it to the received CRC value to verify the accuracy of the data received.

The following structured English procedure shows the steps involved in determining the CRC16 value.

### Write

Device Configuration Data Table (Table 1 of Data Tables)





Size = 44 words (88 bytes = 0x58)



With table containing the following data:

Word #	Data	Word #	Data
1	4	23	0
2	0	24	0
3	0	25	0
4	120	26	0
5	0	27	0
6	120	28	0
7	1000	29	1
8	0	30	1
9	5	31	100
10	10	32	5
11	0	33	6
12	1	34	1
13	125	35	3
14	0	36	0
15	5	37	0
16	1	38	0
17	1	39	0
18	0	40	0
19	1	41	1
20	0	42	2
21	0	43	0
22	1	44	0

Table C.5 Sample Write Sequence

Transmitted from Master	Description/ Direction	Transmitted from Smart Communication Card
[ 10 / 01 / 7B / 10 / 02 / 7B / 00 / 0F / 00 / 00 / 00 / AA / 58 / 00 / 89 / 00 / 00 / 04 / 00 / 00 / 00 / 00 / 00 / 78 / 00 / 00 / 00 / 78 / 00 / E8 / 03 / 00 / 00 / 05 / 00 / 0A / 00 / 00 / 00 / 01 / 00 / 7D / 00 / 00 / 00 / 05 / 00 / 01 / 00 / 01 / 00 / 00 / 00 / 01 / 00 / 00 / 00 / 00 / 01 / 00 / 00 / 00 / 00 / 00 / 00 / 00 / 00 / 00 / 00 / 01 / 00 / 01 / 00 / 64 / 00 / 05 / 00 / 06 / 00 / 01 / 00 / 03 / 00 / 00 / 00 / 00 / 00 / 00 / 00 / 00 / 00 / 00 / 01 / 00 / 02 / 00 / 00 / 00 / 00 / 00 / 10 / 03 / 7E / AD ]	Write Data 	
	DF1 Ack 	[ 10 / 06 ]
[ 10 / 05 / 7B / 85 ]	Poll 	
	Application Ack 	[ 10 / 02 / 00 / 7B / 4F / 00 / 00 / 00 / 10 / 03 / 1F / 84 ]
[ 10 / 06 ]	DF1 Ack 	

Read

Diagnostic Data Table (Appendix ???, Table 20)

Size = 39 words (78 bytes = 0x4E)

With table containing the following data:

Word #	Data	Word #	Data
1	96	23	1
2	1043	24	0
3	2309	25	0
4	1890	26	0
5	1403	27	5
6	11	28	0
7	9	29	0
8	0	30	0
9	0	31	0
10	0	32	0
11	0	33	0
12	0	34	123
13	0	35	0
14	0	36	0
15	0	37	0
16	1	38	0
17	261	39	0
18	17472		
19	0		
20	0		
21	1		
22	15		

Table C.6 Sample Read Sequence

Transmitted from Master	Description/ Direction	Transmitted from Smart Communication Card
[ 10 / 01 / 7B / 10 / 02 / 7B / 00 / 0F / 00 / 00 / 00 / A2 / 4E / 00 / 89 / 00 / 00 / 10 / 03 / 4B / 37 ]	Read Request →	
	DF1 Ack ←	[ 10 / 06 ]
[ 10 / 05 / 7B / 85 ]	Poll →	
	Application Ack ←	[ 10 / 02 / 00 / 7B / 4F / 00 / 00 / 00 / 60 / 00 / 13 / 04 / 05 / 09 / 62 / 07 / 7B / 05 / 0B / 00 / 09 / 00 / 00 / 00 / 00 / 00 / 00 / 00 / 00 / 00 / 00 / 01 / 00 / 00 / F5 / 00 / 40 / 44 / 00 / 00 / 00 / 00 / 01 / 00 / 0F / 01 / 00 / 00 / 00 / 00 / 00 / 00 / 00 / 05 / 00 / 00 / 00 / 00 / 00 / 00 / 00 / 00 / 00 / 00 / 00 / 00 / 7B / 00 / 00 / 00 / 00 / 00 / 00 / 00 / 00 / 00 / 10 / 03 / 61 / C0 ]
[ 10 / 06 ]	DF1 Ack →	

## Sample Ladder Listing

### Ladder Program Description

Appendix D contains sample ladder programs that interface to the Powermonitor II for PLC-5 R I/O, SLC-500 R I/O and SLC-500 RS-232. Because of the similarities of these three programs, only the PLC-5 R I/O example operation is discussed in detail, and the differences in operation for the SLC-500 R I/O and SLC-500 RS-232 are noted. Rung-by-rung descriptions are given for all three.

### PLC-5 R I/O Operation

There are three modes of operation:

- Configuration
- Setpoint
- Run

Each mode uses a single Sequencer Output Instruction in order to process the required block transfers. There are only two block transfers required. These two block transfers are repeated until each mode is completed successfully. For Run mode, the number of block transfers processed by the sequencer is variable. Because there is only one sequencer to be used for three modes, the sequencer's input file must be updated at the beginning of each new mode. The numbers corresponding to the block transfers required for each mode are contained in three separate files. The content of each file is moved to the sequencer's input file at the beginning of its corresponding mode.

### Configuration Mode

During initialization of Configuration mode, the sequencer input file is loaded with the two numbers. These numbers correspond to the configuration table BTW and the diagnostic table BTR. The sequencer length is set to 2. After completion of the configuration data BTW, a diagnostic table BTR is performed to verify that the BTW was successful. If the configuration table BTW is successful, the Configuration mode bit is unlatched and the setpoint mode bit is latched. If the BTW is not successful, the configuration table BTW and diagnostic table BTR sequence continues until the problem is corrected. This most likely requires a change in the configuration table data.

### Setpoint Mode

During initialization of Setpoint mode, the sequencer input file is loaded with the two numbers. These numbers correspond to the setpoint data table BTW and the diagnostic data table BTR. The sequencer length is set to 2. Also, the number of setpoints is written to a counter which is used to determine the address of the user populated setpoint data tables. After the completion of the setpoint BTW, a diagnostic table BTR is performed to verify the BTW was successful. If it was not successful, further setpoints will not be written until the setpoint data table that caused the error is corrected. If all the setpoints are written correctly, the Setpoint mode bit is unlatched, and the Run mode bit is latched.

### Run Mode

During initialization of Run mode, the sequencer input file is loaded with the numbers corresponding to the block transfers to be performed. Once Run mode has begun, the ladder program will remain in this mode.

**Note:** The speed with which the processor performs the block transfers may be altered by rearranging or changing the size of the block transfer sequence. However, the availability of new data values is controlled by the Powermonitor II table update rate.

### SLC-500 R I/O Operation

The SLC-500 R I/O requires more attention. BTW and BTR instructions subroutines have been developed for implementation of the SLC-500 R I/O sample ladder. The BTR and BTW subroutines are patterned after the block transfer examples shown in the R I/O Scanner User Manual ( Cat. No. 1747-SN, Publication 1747-6.6 – February 1995), pp. 5-23 to 5-28. Refer to this manual for a more detailed description of how these block transfer routines work.

In addition to the two files that contain the BTR and BTW subroutines, there is a third subroutine file. This file executes a small amount of initialization ladder before each block transfer subroutine.

The SLC-500 R I/O version requires that all read and write tables be 64 words in length. This is a necessary requirement stemming from the use of the block transfer subroutines.

A four word length control file needs to be initialized for each individual block transfer subroutine. The initialization values for each word are discussed in the Data Files Used section.

### SLC-500 RS-232 Operation

Use of an SLC-500 MSG instruction in place of the BTW and BTR instructions is the only difference between the PLC-5 R I/O and the SLC-500 RS-232 versions of the Powermonitor II sample ladder.

### PLC-5 R I/O Data Files Used

Data File Address	Data File Size	Description
B3	20	b3/0 Configuration mode enable
		b3/2 Run mode enable
		b3/1 Setpoint mode enable
		b3/300 One-shot bit
		b3/301 One-shot bit
		b3/302 One-shot bit
		b3/303 One-shot bit
		b3/304 One-shot bit
N9	1	N9:0 Sequencer output
N10	variable	N10:0 Sequencer input

Data File Address	Data File Size	Description
N11	3	N11:0 Sequencer input data for configuration mode
N12	3	N12:0 Sequencer input data for setpoint mode
N13	variable	N13:0 Sequencer input data for run mode
N20	2	N20:0 Number of setpoints
		N20:1 Temporary storage for setpoint address
N22	21	Setpoint #1 location
N23	21	Setpoint #2 location
•		•
•		•
N39	21	Setpoint #20 location
R6:0		Sequencer control

#### BTR Data Table Locations

(control / data)		
N40 / N70	54	Voltage/current data
N41 / N71	63	Real-time power
N42 / N72	46	Cumulative power
N43 / N73	45	Device configuration
N44 / N74	31	Communication configuration
N45 / N75	43	Demand
N46 / N76	61	Even harmonic distortion
N47 / N77	62	Odd harmonic distortion
N48 / N78	59	Even harmonic magnitude
N49 / N79	58	Odd harmonic magnitude
N50 / N80	57	Even harmonic phase
N51 / N81	56	Odd harmonic phase
N52 / N82	40	Diagnostic
N53 / N83	39	Relay/setpoint

#### BTW Data Table Locations

(control / data)		
N54 / N84	23	Command
N55 / N85	45	Device configuration
N56 / N86	21	Setpoint

Sequencer input file N10 contains a list of the block transfers required to complete the active mode. The contents of N10 are copied from N11 for Configuration mode, N12 for Setpoint mode and N13 for Run mode during each mode's initialization.

The reset word for the sequencer is N10:1. The first word in the rotation of the sequencer N10:1. The value in N10:0 must be the same as that in N10:1. This means N11:0 must equal N11:1, N12:0 must equal N12:1 and N13:0 must equal N13:1. The size of file N10 is equal to the size of the largest sequencer input file. For configuration and setpoint modes, this size will always be 2. In Run mode the size depends on the number of block transfers to be performed. The sequencer length may be expanded or reduced for run mode. It is imperative that the corresponding file that serves as the source of the sequencer's input file, N13, must be modified accordingly.

**Important:** Failure to modify the length of file N13 for a modification of the run mode sequencer size will result in improper operation of the run mode block transfer ladder, and possible FAULT of the processor due to invalid indirect offsets.

### File Data Values

Prior to running the sample ladder, each of the three sequencer initialization files need to be loaded with the numbers that correspond to each mode's block transfer sequence. The following is a list of each mode's initialization file and the required/possible numbers to be stored in each. The first value of a block transfer sequence must be duplicated in both position 0 and 1 of an initialization file.

#### N11 – Configuration Mode

Required numbers are 55, 55, and 52.

#### N12 – Setpoint Mode

Required numbers are 56, 56, and 52.

#### N13 – Run Mode

Possible numbers are 40, 41, 42, 43, 44, 45, 46, 47, 48, 49, 50, 51, 52, 53, 54, 55, 56

### SLC-500 R I/O Data Files Used

There are three differences between the SLC-500 R I/O and PLC-5 implementations of the sample ladder.

1. All BTR and BTW control files are four words in length and need to be initialized. For control file x, this initialization is:

x:0 = block transfer control bits (M0 “control flags”) See *R I/O Scanner User Manual*, Publication 1747-6.6. (Bit 0 = BTW; Bit 7 = BTR)

x:1 = block transfer size

x:2 = SLC-5 logical address (logical rack, group and slot) See *R I/O Scanner User Manual*.

x:3 = data file location

For example, the control file for a configuration table BTW, file 55 should be initialized to:

55:0 = 0 (BTW)

55:1 = 44 (Configuration table block transfer size)

55:2 = 100 (Logical rack 1, group 0, slot 0)

55:3 = 85 (Configuration table data file)

2. All data storage files for BTR and BTW subroutine execution are 64 words in length.
3. The SLC-500 R I/O block transfer subroutine N15, requires a file that is eight words in length. In this example N15 is used. No initialization is required.

### SLC-500 RS-232 Data Files Used

Same as PLC-5 R I/O.

## Sample Ladder Listing

These example ladder programs show a way to configure the block transfers for the Powermonitor II.



**ATTENTION:** Proper operation of the ladder program is the responsibility of the user. No warranty is expressed or implied by using these ladder configurations.

These ladders are subject to change.

PLC-5 R I/O

Rung 2:0

Latch configuration mode and unlatch setpoint and run modes. Clear one-shot bits.

```

Rung 2:0
      Enable configuration mode and clear one shot bits.
| First-Pass                               Config
| Bit                                       Mode
| S:1                                       B3
|-----] [-----] (L)-----+-----+
| 15                                       0
|                                       Setpoint
|                                       Mode
|                                       B3
|-----] [-----] (U)-----+-----+
|                                       1
|                                       Run
|                                       Mode
|                                       B3
|-----] [-----] (U)-----+-----+
|                                       2
|                                       Clear
|                                       One Shots
|+CLR-----+
|+CLEAR      ++
| |Destination B3:18|
| | 1000000000000000|
|+-----+
|+CLR-----+
|+CLEAR      ++
| |Destination B3:19|
| | 0000000000000000|
|+-----+
    
```

Rung 2:1

Initialize the sequencer for configuration mode. This includes loading the sequencer input file with the configuration block transfer numbers, setting the sequencer length, clearing the sequencer position and moving the reset word into the sequencer's output file.

```

Rung 2:1
      Initialize for appropriate mode.
| First-Pass                               Initialize
| Bit                                       Sequencer
| S:1                                       Input File
|-----] [-----] +COP-----+
| 15                                       +COPY FILE ++
|                                       |Source  #N11:0|
|                                       |Destination #N10:0|
|                                       |Length      3|
|+-----+
|                                       Initialize
|                                       Sequencer
|                                       Length
|+MOV-----+
|+MOVE      ++
| |Source      2|
| |Destination R6:0.LEN|
| |          7|
|+-----+
|                                       Initialize
|                                       Sequencer
|                                       Position
|+CLR-----+
|+CLEAR      ++
| |Destination R6:0.POS|
| |          5|
|+-----+
|                                       Initialize
|                                       Sequencer
|                                       Address
|+MOV-----+
|+MOVE      ++
| |Source      N10:0|
| |          40|
| |Destination N9:0|
| |          40|
|+-----+
    
```

**Rung 2:2**

If the configuration BTW and diagnostic BTR are done, check that the diagnostic table parameters indicate a successful BTW (word 36 and 37 equal 0). If so, unlatch the configuration mode bit and latch the setpoint mode bit.

Rung 2:2  
Begin setpoint mode once configuration is complete.

Config Mode	Config BTW Done	Config BTR Done	Status Bad Table Check	Status - Bad Table Check	Status - Bad Param. Check	Config Mode
B3	N55:0	N52:0	+CMP	+CMP	+CMP	B3
0	13	13	+COMPARE		+COMPARE	(U) 0
			Expression		Expression	Setpoint Mode
			N82:36 = 0		N82:37 = 0	B3
						(L) 1

**Rung 2:3**

Initialize the sequencer for setpoint mode. Same functionality as Rung 2:0.

Rung 2:3  
Initialize for appropriate mode.

Setpoint Mode	One Shot 1	Initialize Sequencer Input File
B3	B3	+COP
1	300	+COPY FILE
		Source #N12:0
		Destination #N10:0
		Length 3
		Initialize Sequencer Length
		+MOV
		++MOVE
		Source 2
		Destination R6:0.LEN
		7
		Initialize Sequencer Position
		+CLR
		++CLEAR
		Destination R6:0.POS
		5
		Initialize Sequencer Address
		+MOV
		++MOVE
		Source N10:0
		40
		Destination N9:0
		40

**Rung 2:4**

Move the number of setpoints into the setpoint address counter. Reset the setpoint counter.

Rung 2:4  
Load number of setpoints into setpoint counter.

Setpoint Mode	One Shot 2	Number of Setpoints
B3	B3	+MOV
1	301	++MOVE
		Source N20:0
		3
		Destination C5:0.PRE
		3
		C5:0
		(RES)

**Rung 2:5**

Initialize the sequencer for run mode. Same functionality as Rungs 2:0 and 2:1.

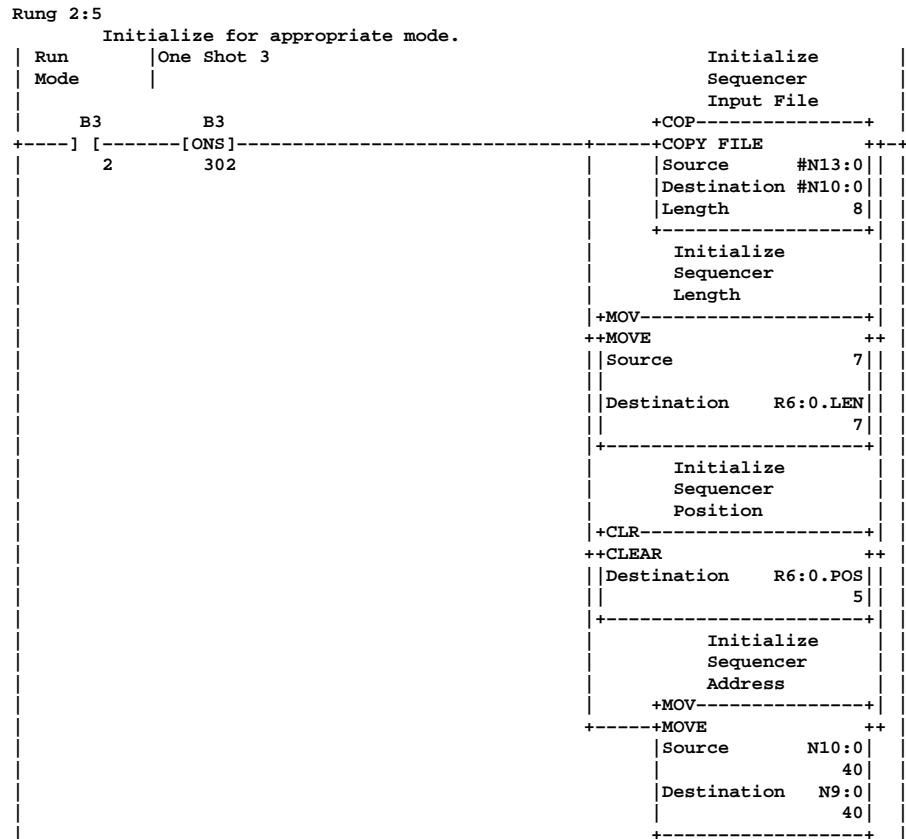

**Rung 2:6**

This is the main block transfer sequencer. The sequencer output word, N9:0, is updated whenever the previous block transfer is done or fails.

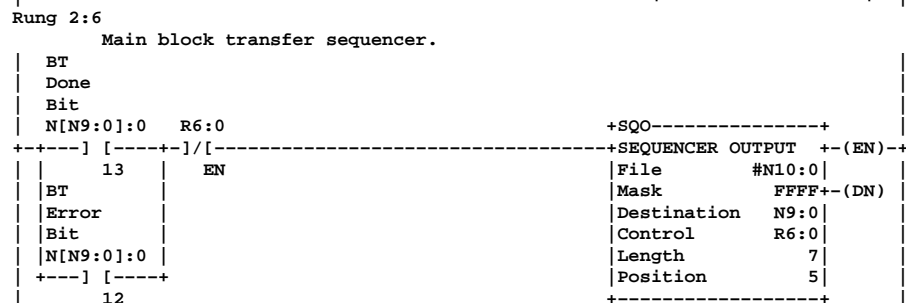

**Rung 2:7**

Voltage/current BTR.

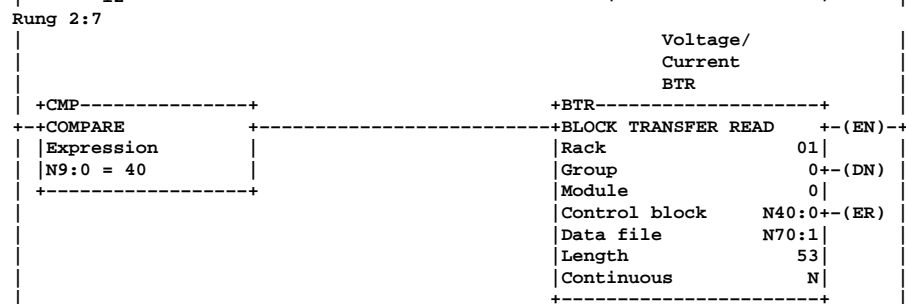

**Rung 2:8**

Real time power BTR.

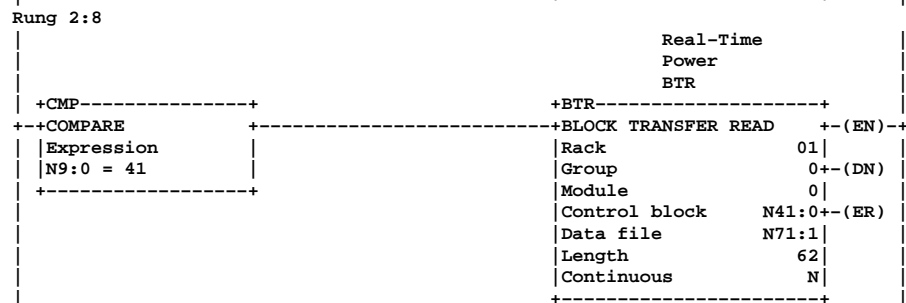



**Rung 2:9**

Cumulative power BTR.

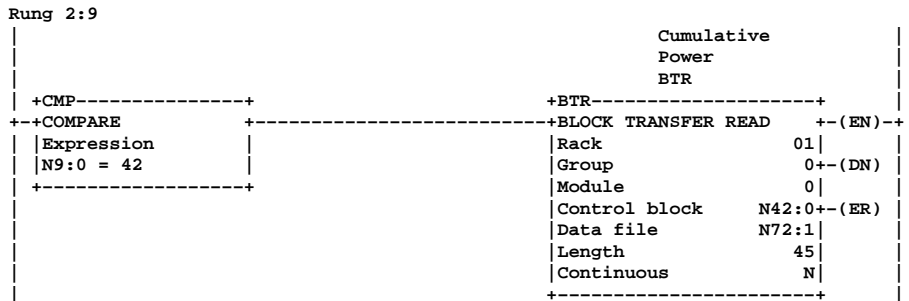

**Rung 2:10**

Device configuration BTR.

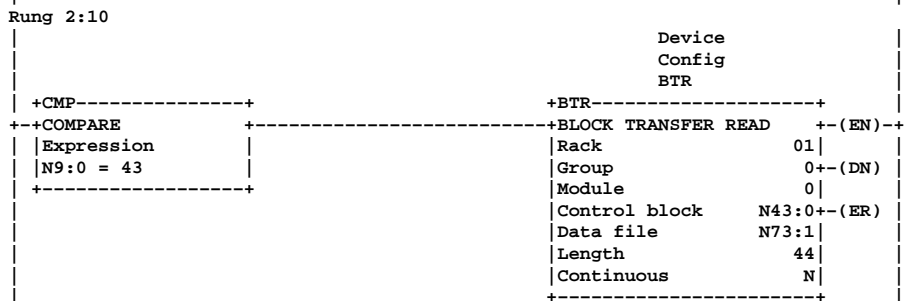

**Rung 2:11**

Communication configuration BTR.

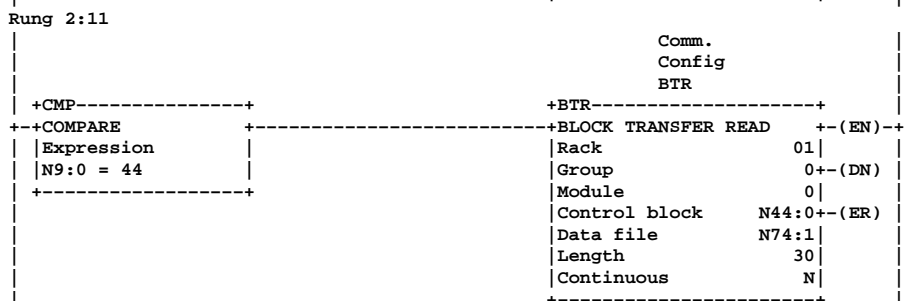

**Rung 2:12**

Demand BTR.

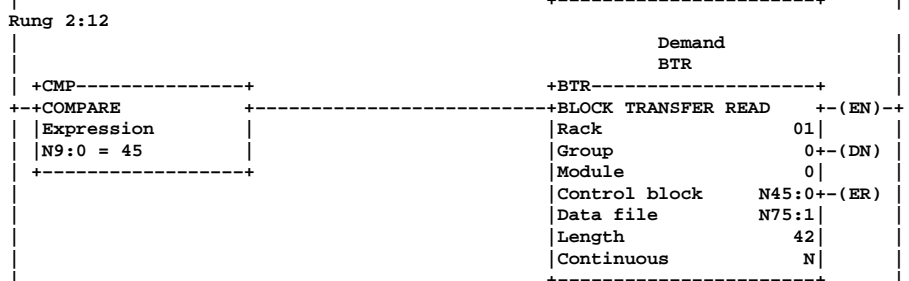

**Rung 2:13**

Even harmonic distortion BTR.

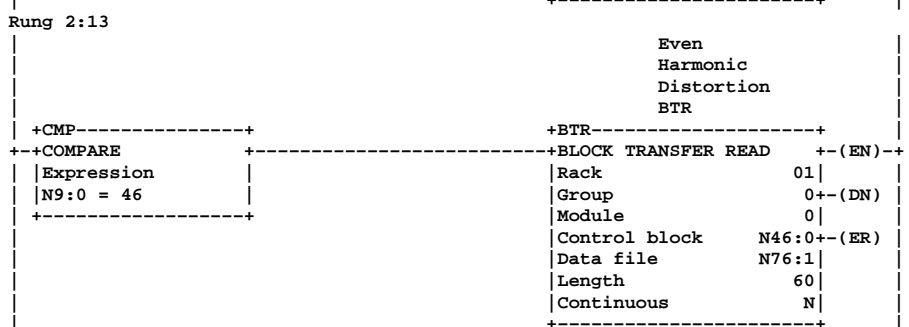

**Rung 2:14**

Odd harmonic distortion BTR.

Rung 2:14		Odd Harmonic Distortion BTR
+CMP-----+	+BTR-----+	
+COMPARE	+BLOCK TRANSFER READ	++(EN)-+
Expression	Rack	01
N9:0 = 47	Group	0+-(DN)
+-----+	Module	0
	Control block	N47:0+-(ER)
	Data file	N77:1
	Length	61
	Continuous	N
	+-----+	

**Rung 2:15**

Even harmonic magnitude BTR.

Rung 2:15		Even Harmonic Magnitude BTR
+CMP-----+	+BTR-----+	
+COMPARE	+BLOCK TRANSFER READ	++(EN)-+
Expression	Rack	01
N9:0 = 48	Group	0+-(DN)
+-----+	Module	0
	Control block	N48:0+-(ER)
	Data file	N78:1
	Length	58
	Continuous	N
	+-----+	

**Rung 2:16**

Odd harmonic magnitude BTR.

Rung 2:16		Odd Harmonic Magnitude BTR
+CMP-----+	+BTR-----+	
+COMPARE	+BLOCK TRANSFER READ	++(EN)-+
Expression	Rack	01
N9:0 = 49	Group	0+-(DN)
+-----+	Module	0
	Control block	N49:0+-(ER)
	Data file	N79:1
	Length	57
	Continuous	N
	+-----+	

**Rung 2:17**

Even harmonic phase BTR.

Rung 2:17		Even Harmonic Phase BTR
+CMP-----+	+BTR-----+	
+COMPARE	+BLOCK TRANSFER READ	++(EN)-+
Expression	Rack	01
N9:0 = 50	Group	0+-(DN)
+-----+	Module	0
	Control block	N50:0+-(ER)
	Data file	N80:1
	Length	56
	Continuous	N
	+-----+	

**Rung 2:18**

Odd harmonic phase BTR.

Rung 2:18		Odd Harmonic Phase BTR
+CMP-----+	+BTR-----+	
+COMPARE	+BLOCK TRANSFER READ	++(EN)-+
Expression	Rack	01
N9:0 = 51	Group	0+-(DN)
+-----+	Module	0
	Control block	N51:0+-(ER)
	Data file	N81:1
	Length	55
	Continuous	N
	+-----+	



**Rung 2:24**

This rung is activated once when the sequencer output file changes to setpoint BTW. Its purpose is to determine the address of the next setpoint data and to copy the data residing at this address into the setpoint BTW data location. This is accomplished by first adding an address offset to a base address to determine the location of the next setpoint data. The data residing at the resulting address is then transferred to the setpoint BTW data location. A counter is used to determine the address offset. Prior to the first setpoint BTW, the counter is automatically incremented. For subsequent setpoint BTWs, the counter is incremented when the diagnostic table BTR for the previous setpoint BTW is successful. For example, the 3rd setpoint will reside at base address 24. In this case, a counter value of 3 will be added to the base address 21. The data residing at location 24 will then be transferred into the setpoint BTW data location N86:1.

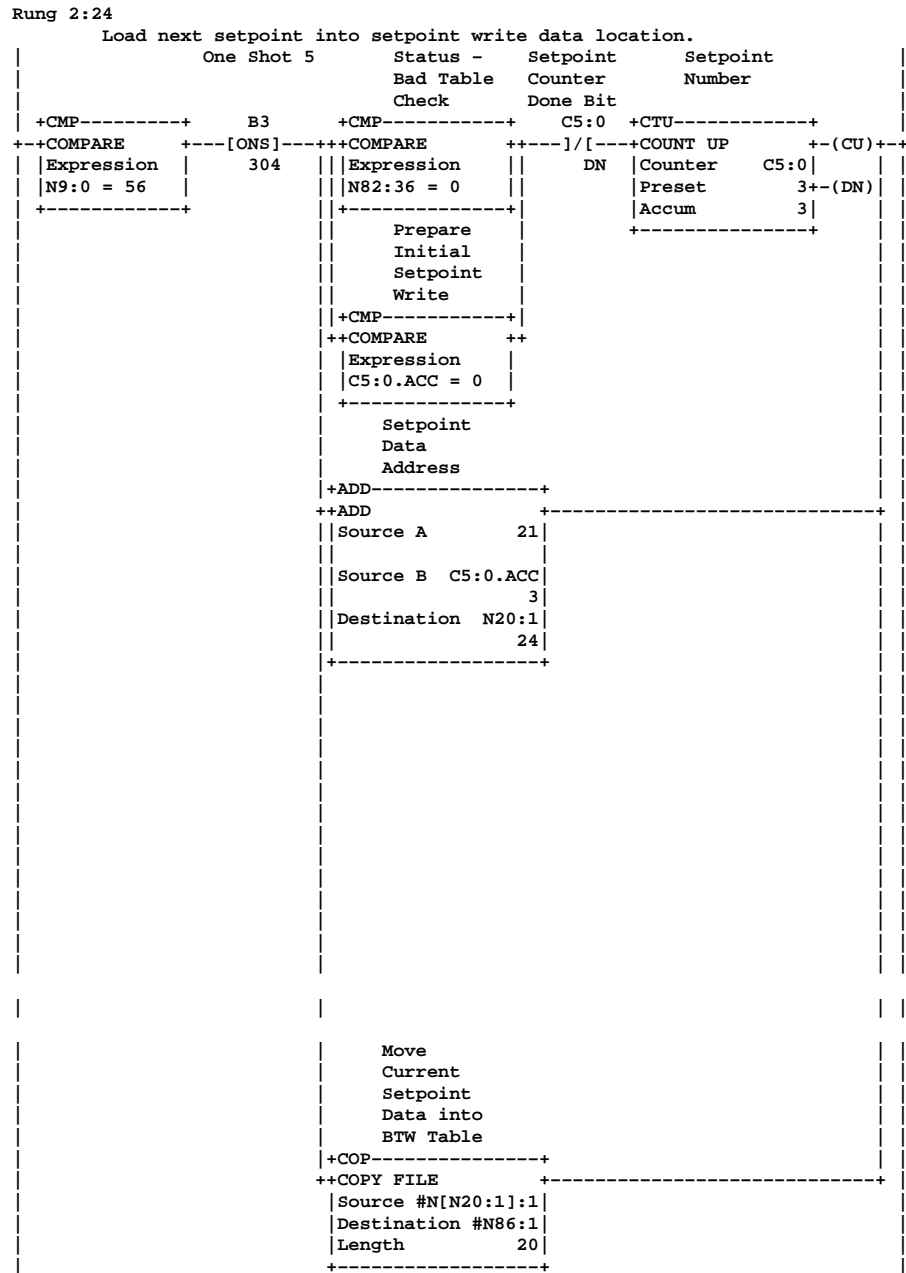

**Rung 2:25**

Setpoint BTW.

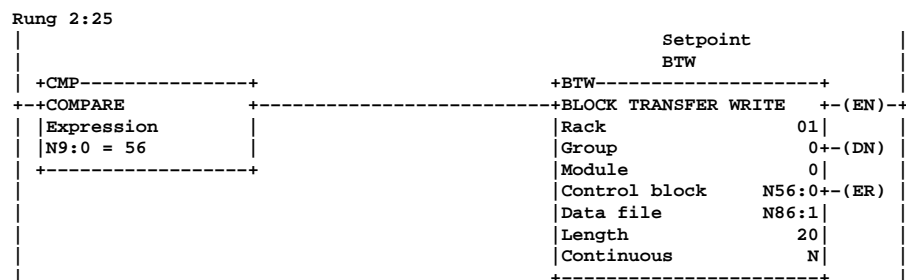

**Rung 2:26**

End of file.

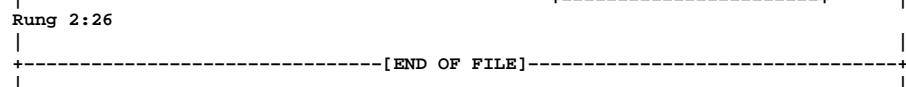

**SLC-500 R I/O**

**Rung 2:0**

Latch configuration mode and unlatch setpoint and run modes. Clear one-shot bits.

```

Rung 2:0      Enable configuration mode and clear one shot bits.
| First      Config
| Pass      Mode
| S:1      B3
|-----] [-----] (L)-----]
| 15      0
|          Setpoint
|          Mode
|          B3
|-----] (U)-----]
|          1
|          Run
|          Mode
|          B3
|-----] (U)-----]
|          2
|          Clear
|          One Shots
|+CLR-----+
|+CLEAR-----+
| |Dest      B3:18 |
| | 0100000000000000 |
|+-----+
|+CLR-----+
|+CLEAR-----+
| |Dest      B3:19 |
| | 0000000000000000 |
|+-----+
    
```

**Rung 2:1**

Initialize the sequencer for configuration mode. This includes loading the sequencer input file with the configuration block transfer numbers, setting the sequencer length, clearing the sequencer position and moving the reset word into the sequencer's output file. Also, the sequencer's output file done bit is unlatched to insure that the next rung is not active immediately and the block transfer preparation subroutine is called.

```

Rung 2:1      Initialize for appropriate mode.
| First
| Pass
| S:1
|-----] [-----]
| 15
|          Initialize
|          Sequencer
|          Input File
|+COP-----+
|+COPY FILE-----+
| |Source      #N11:0 |
| |Dest        #N10:0 |
| |Length      3 |
|+-----+
|          Initialize
|          Sequencer
|          Length
|+MOV-----+
|+MOVE-----+
| |Source      2 |
| |Dest        R6:0.LEN |
| |           1 |
|+-----+
|          Initialize
|          Sequencer
|          Position
|+CLR-----+
|+CLEAR-----+
| |Dest        R6:0.POS |
| |           1 |
|+-----+
|          Initialize
|          Sequencer
|          Address
|+MOV-----+
|+MOVE-----+
| |Source      N10:0 |
| |           40 |
| |Dest        N9:0 |
| |           40 |
|+-----+
|          BT Done
|          Bit
|          N[N9:0]:0
|-----] (U)-----]
|          13
|          Prepare
|          For BT
|+JSR-----+
|+JUMP TO SUBROUTINE+
| |SBR file number 5 |
|+-----+
    
```



**Rung 2:2**

If the configuration BTW and diagnostic BTR are done, check that the diagnostic table parameters indicate a successful BTW (word 36 and 37 equal 0). If so, unlatch the configuration mode bit and latch the setpoint mode bit.

```
Rung 2:2
      Begin setpoint mode once configuration is complete.
      Config Mode | Config Mode | Status | Status - | Config Mode
      | BTW | Done | BTR | Done | Bad Table | Check
      B3 | N55:0 | N52:0 | +EQU-----+ | B3
      ] [-----] [-----] [-----] +EQUAL-----+ | (U)
      0 | 13 | 13 | | Source A N82:36 | | 0
      | | | | | Source B 0 | | 0
      | | | | |-----+ | |
      | | | | | | Setpoint |
      | | | | | | Mode |
      | | | | | | B3 |
      | | | | | |-----+ |
      | | | | | | (L) |
      | | | | | | 1 |
```

**Rung 2:3**

Initialize the sequencer for setpoint mode. Same functionality as Rung 2:0.

```
Rung 2:3
      Initialize for appropriate mode.
      Setpoint Mode | One Shot 1 | Initialize Sequencer Input File
      B3 | B3 | +COP-----+
      ] [-----][OSR]-----+ +COPY FILE +
      1 | 300 | | | Source #N12:0 |
      | | | | | | Dest #N10:0 |
      | | | | | | Length 3 |
      | | | | | |-----+
      | | | | | | Initialize |
      | | | | | | Sequencer |
      | | | | | | Length |
      | | | | | |-----+
      | | | | | | +MOV-----+
      | | | | | | +MOVE | |
      | | | | | | | Source 2 |
      | | | | | | | Dest R6:0.LEN |
      | | | | | | | 1 |
      | | | | | |-----+
      | | | | | | Initialize |
      | | | | | | Sequencer |
      | | | | | | Position |
      | | | | | |-----+
      | | | | | | +CLR-----+
      | | | | | | +CLEAR | |
      | | | | | | | Dest R6:0.POS |
      | | | | | | | 1 |
      | | | | | |-----+
      | | | | | | Initialize |
      | | | | | | Sequencer |
      | | | | | | Address |
      | | | | | |-----+
      | | | | | | +MOV-----+
      | | | | | | +MOVE | |
      | | | | | | | Source N10:0 |
      | | | | | | | 40 |
      | | | | | | | Dest N9:0 |
      | | | | | | | 40 |
      | | | | | |-----+
      | | | | | | Prepare |
      | | | | | | For BT |
      | | | | | |-----+
      | | | | | | +JSR-----+
      | | | | | | +JUMP TO SUBROUTINE+
      | | | | | | | SBR file number 5 |
      | | | | | |-----+
      | | | | | |
```

**Rung 2:4**

Move the number of setpoints into the setpoint address counter. Reset the setpoint counter.

```
Rung 2:4
      Load number of setpoints into setpoint counter.
      Setpoint Mode | One Shot 2 | Number Of Setpoints
      B3 | B3 | +MOV-----+
      ] [-----][OSR]-----+ +MOVE |
      1 | 301 | | | Source N20:0 |
      | | | | | | 3 |
      | | | | | | Dest C5:0.PRE |
      | | | | | | 3 |
      | | | | | |-----+
      | | | | | | C5:0 |
      | | | | | |-----+
      | | | | | | (RES) |
```

**Rung 2:5**

Initialize the sequencer for run mode. Same functionality as Rungs 2:0 and 2:1.

```

Rung 2:5
      Initialize for appropriate mode.
Run   | One Shot 3
Mode  |
-----|-----
      B3      B3      +COP-----+
      2      302     +COPY FILE-----+
      |         |         |Source  #N13:0|
      |         |         |Dest    #N10:0|
      |         |         |Length   4|
      |         |         +-----+
      |         |         Initialize
      |         |         Sequencer
      |         |         Length
      |         |         +MOV-----+
      |         |         +-+MOVE-----+
      |         |         |Source      3|
      |         |         |Dest    R6:0.LEN|
      |         |         |         1|
      |         |         +-----+
      |         |         Initialize
      |         |         Sequencer
      |         |         Position
      |         |         +CLR-----+
      |         |         +-+CLEAR-----+
      |         |         |Dest    R6:0.POS|
      |         |         |         1|
      |         |         +-----+
      |         |         Initialize
      |         |         Sequencer
      |         |         Address
      |         |         +MOV-----+
      |         |         +-+MOVE-----+
      |         |         |Source    N10:0|
      |         |         |         40|
      |         |         |Dest      N9:0|
      |         |         |         40|
      |         |         +-----+
      |         |         Prepare
      |         |         For BT
      |         |         +JSR-----+
      |         |         +-+JUMP TO SUBROUTINE+
      |         |         |SBR file number 5|
      |         |         +-----+
  
```

**Rung 2:6**

This is the main block transfer sequencer. The sequencer output word, N9:0, is updated whenever the previous block transfer is done or fails. After each sequencer increment, the block transfer preparation subroutine is called.

```

Rung 2:6
      Main block transfer sequencer.
BT Done
Bit
N[N9:0]:0  R6:0
-----|-----
      13      EN      +SQO-----+
      |         |         +SEQUENCER OUTPUT +- (EN)+
      |         |         |File    #N10:0+- (DN)|
      |         |         |Mask    FFFF|
      |         |         |Dest    N9:0|
      |         |         |Control  R6:0|
      |         |         |Length   3|
      |         |         |Position  1|
      |         |         +-----+
      |         |         Prepare
      |         |         For BT
      |         |         +JSR-----+
      |         |         +-+JUMP TO SUBROUTINE+
      |         |         |SBR file number 5|
      |         |         +-----+
      BT Error
      Bit
      N[N9:0]:0
      -----|-----
      12
  
```

**Rung 2:7**

Voltage/current BTR.

```

Rung 2:7
      Perform appropriate block transfer read.
+-----+
+EQU-----+
+-----+
|Source A   N9:0|
|         40|
|Source B   40|
+-----+
+-----+
+JSR-----+
+-----+
+JUMP TO SUBROUTINE+
|SBR file number 3|
+-----+
  
```

**Rung 2:8**

Real time power BTR.

```

Rung 2:8
Perform appropriate block transfer read.
|+EQU-----+
|+EQUAL      +-----+JUMP TO SUBROUTINE+
|Source A    N9:0 |SBR file number 3|
|              40 |-----+
|Source B    41 |
|              |
|-----+

```

**Rung 2:9**

Cumulative power BTR.

```

Rung 2:9
Perform appropriate block transfer read.
|+EQU-----+
|+EQUAL      +-----+JUMP TO SUBROUTINE+
|Source A    N9:0 |SBR file number 3|
|              40 |-----+
|Source B    42 |
|              |
|-----+

```

**Rung 2:10**

Device configuration BTR.

```

Rung 2:10
Perform appropriate block transfer read.
|+EQU-----+
|+EQUAL      +-----+JUMP TO SUBROUTINE+
|Source A    N9:0 |SBR file number 3|
|              40 |-----+
|Source B    43 |
|              |
|-----+

```

**Rung 2:11**

Communication configuration BTR.

```

Rung 2:11
Perform appropriate block transfer read.
|+EQU-----+
|+EQUAL      +-----+JUMP TO SUBROUTINE+
|Source A    N9:0 |SBR file number 3|
|              40 |-----+
|Source B    44 |
|              |
|-----+

```

**Rung 2:12**

Demand BTR.

```

Rung 2:12
Perform appropriate block transfer read.
|+EQU-----+
|+EQUAL      +-----+JUMP TO SUBROUTINE+
|Source A    N9:0 |SBR file number 3|
|              40 |-----+
|Source B    45 |
|              |
|-----+

```

**Rung 2:13**

Even harmonic distortion BTR.

```

Rung 2:13
Perform appropriate block transfer read.
|+EQU-----+
|+EQUAL      +-----+JUMP TO SUBROUTINE+
|Source A    N9:0 |SBR file number 3|
|              40 |-----+
|Source B    46 |
|              |
|-----+

```

**Rung 2:14**

Odd harmonic distortion BTR.

```

Rung 2:14
Perform appropriate block transfer read.
|+EQU-----+
|+EQUAL      +-----+JUMP TO SUBROUTINE+
|Source A    N9:0 |SBR file number 3|
|              40 |-----+
|Source B    47 |
|              |
|-----+

```

**Rung 2:15**

Even harmonic magnitude BTR.

```

Rung 2:15
Perform appropriate block transfer read.
|+EQU-----+
|+EQUAL      +-----+JUMP TO SUBROUTINE+
|Source A    N9:0 |SBR file number 3|
|              40 |-----+
|Source B    48 |
|              |
|-----+

```

**Rung 2:16**

Odd harmonic magnitude BTR.

```

Rung 2:16
Perform appropriate block transfer read.
|+EQU-----+
|+EQUAL      +-----+JUMP TO SUBROUTINE+
|Source A    N9:0 |SBR file number 3|
|              40 |-----+
|Source B    49 |
|              |
|-----+

```



**Rung 2:17**

Even harmonic phase BTR.

```

Rung 2:17
Perform appropriate block transfer read.
+-----+
+EQU-----+
-+EQUAL +-----+
|Source A      N9:0|
|              40|
|Source B      50|
|              |
+-----+
+-----+
+JSR-----+
+JUMP TO SUBROUTINE+
|SBR file number 3|
+-----+
    
```

**Rung 2:18**

Odd harmonic phase BTR.

```

Rung 2:18
Perform appropriate block transfer read.
+-----+
+EQU-----+
-+EQUAL +-----+
|Source A      N9:0|
|              40|
|Source B      51|
|              |
+-----+
+-----+
+JSR-----+
+JUMP TO SUBROUTINE+
|SBR file number 3|
+-----+
    
```

**Rung 2:19**

Diagnostic BTR.

```

Rung 2:19
Perform appropriate block transfer read.
+-----+
+EQU-----+
-+EQUAL +-----+
|Source A      N9:0|
|              40|
|Source B      52|
|              |
+-----+
+-----+
+JSR-----+
+JUMP TO SUBROUTINE+
|SBR file number 3|
+-----+
    
```

**Rung 2:20**

Relay/setpoint BTR.

```

Rung 2:20
Perform appropriate block transfer read.
+-----+
+EQU-----+
-+EQUAL +-----+
|Source A      N9:0|
|              40|
|Source B      53|
|              |
+-----+
+-----+
+JSR-----+
+JUMP TO SUBROUTINE+
|SBR file number 3|
+-----+
    
```

**Rung 2:21**

Command BTW.

```

Rung 2:21
Perform appropriate block transfer write.
+-----+
+EQU-----+
-+EQUAL +-----+
|Source A      N9:0|
|              40|
|Source B      54|
|              |
+-----+
+-----+
+JSR-----+
+JUMP TO SUBROUTINE+
|SBR file number 4|
+-----+
    
```

**Rung 2:22**

Configuration BTW.

```

Rung 2:22
Perform appropriate block transfer write.
+-----+
+EQU-----+
-+EQUAL +-----+
|Source A      N9:0|
|              40|
|Source B      55|
|              |
+-----+
+-----+
+JSR-----+
+JUMP TO SUBROUTINE+
|SBR file number 4|
+-----+
    
```

**Rung 2:23**

If the setpoint counter done bit is set, the last setpoint BTW occurred and was followed by a diagnostic BTR. If the diagnostic table indicates a successful setpoint BTW, setpoint mode is done. The setpoint mode bit is unlatched, and the run mode bit is latched.

```

Rung 2:23
Begin run mode once all setpoint block transfers are complete.
One Shot 4      Status -      Setpoint      Setpoint
                Bad Table      Counter      Mode
                Check
                Done Bit
+-----+
+EQU-----+
-+EQUAL +-----+
|Source A      N9:0|
|              40|
|Source B      56|
|              |
+-----+
+-----+
+JSR-----+
+JUMP TO SUBROUTINE+
|SBR file number 4|
+-----+
                B3
                C5:0
                B3
                (U)
                1
                Run
                Mode
                B3
                (L)
                2
    
```

**Rung 2:24**

This rung is activated once when the sequencer output file changes to setpoint BTW. Its purpose is to determine the address of the next setpoint data and to copy the data residing at this address into the setpoint BTW data location. This is accomplished by first adding an address offset to a base address to determine the location of the next setpoint data. The data residing at the resulting address is then transferred to the setpoint BTW data location. A counter is used to determine the address offset. Prior to the first setpoint BTW, the counter is automatically incremented. For subsequent setpoint BTWs, the counter is incremented when the diagnostic table BTR for the previous setpoint BTW is successful. For example, the 3rd setpoint will reside at base address 24. In this case, a counter value of 3 will be added to the base address 21. The data residing at location 24 will then be transferred into the setpoint BTW data location N86:1.

```

Rung 2:24
Load next setpoint into setpoint write data location.
One Shot 5           Status -          Setpoint          Setpoint
                    Bad Table         Counter          Number
                    Check              Done Bit
+-----+-----+-----+-----+
+EQU-----+      B3      +EQU-----+      C5:0 +CTU-----+
+-----+-----+-----+-----+
+EQUAL      +-[OSR]-----+ +EQUAL      +---] / [-COUNT UP +-(CU)---+
|Source A N9:0|         304| |Source A  N82:36| |DN|Counter  C5:0+-(DN)|
|         40|         | |         0| |Preset     3|
|Source B  56|         | |Source B    0| |Accum      3|
+-----+-----+-----+-----+
                    Prepare
                    Initial
                    Setpoint
                    Write
+-----+-----+
+EQU-----+
+-----+-----+
+EQUAL      +---] / [-COUNT UP +-(CU)---+
|Source A C5:0.ACC|
|         3|
|Source B    0|
+-----+-----+
                    Setpoint
                    Data
                    Address
+ADD-----+
+-----+-----+
+ADD
|Source A      21|
|Source B C5:0.ACC|
|         3|
|Dest      N20:1|
|         24|
+-----+-----+
                    Move
                    Current
                    Setpoint
                    Data Into
                    BTW Table
+COP-----+
+-----+-----+
+COPY FILE
|Source #N[N20:1]:1|
|Dest      #N86:1|
|Length    20|
+-----+-----+

```

**Rung 2:25**

Setpoint BTW.

```

Rung 2:25
Perform appropriate block transfer write.
+-----+-----+-----+-----+
+EQU-----+
+-----+-----+-----+-----+
+EQUAL      +-----+-----+ +JUMP TO SUBROUTINE+---+
|Source A      N9:0|         |SBR file number 4|
|         40|         |
|Source B      56|         |
+-----+-----+-----+-----+

```

**Rung 2:26**

End of file.

```

Rung 2:26
-----+-----+
+END+

```

### BTR and BTW Subroutines

The SLC-500 R I/O BTR and BTW subroutines mimic the read and write block transfer examples listed in the back of the *Publication 1747-6.6, R I/O Scanner User Manual*. The following rung descriptions and notes pertain to modifications or additions to these examples.

1. The BTR and BTW subroutines use different files and bits than those given in the R I/O Scanner Manual. The substitutions are:

B3:0 – B3:5 are replaced by N15:0 – N15:4

B3:100 is replaced by the control word corresponding to the sequencer's output file ( N[N9:0]:0 ).

2. The file M0.1 is used for the BTW while file M0.2 is used for the BTR routine.
3. The first rung of the block transfer examples in the *Publication 1747-6.6, R I/O Scanner User Manual* is not used in the BTR and BTW subroutines. This is because the function performed by that rung, initializing the control flags for the M file block transfer, is done in the BTR or BTW subroutine at the time the BTR and BTW block transfer are initiated. These control flags, which are moved into the M file control buffers at the block transfer initiation, are initialized for each control file associated with block transfer operations ( see Data Files Used section ).

### BTR ( File 3 )

#### Rung 3:0

Copy the BTR status area to a file which will be used throughout the program. This avoids addressing the M1 file multiple times during each program scan. Each time an instruction containing an M1 file bit, word or file is scanned by the processor, an immediate data transfer to the module occurs and therefore will impact the overall processor time.

#### Rung 3:1

Unlatch the bit that continues to check the BTR status. When a BTR is complete, the done bit is set. The ladder program must unlatch the enable bit, then wait for the SN module to turn off the done bit before another BTR to the same M-file location can be initiated.

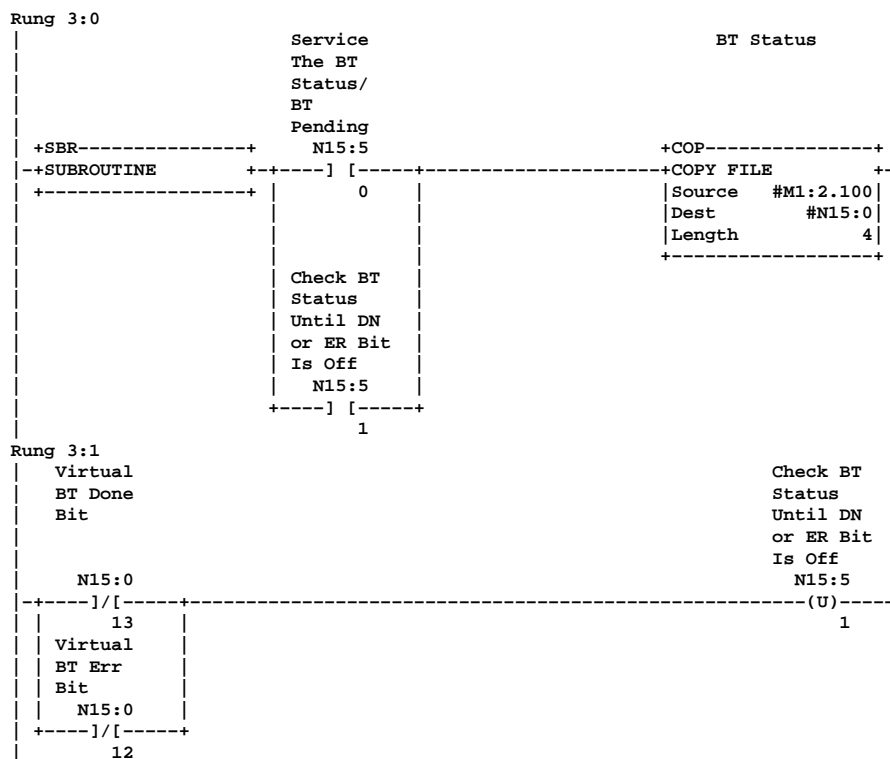

**Rung 3:2**

When a BTR successfully completes, buffer the BT data and unlatch the BT enable bit. As shown, 63 words are copied to the BTR destination file, beginning at word 1, in order to match the Powermonitor II data table layout. Also, unlatch the BTR pending bit and latch the bit that continues checking the BTR status until the SN module turns off the done bit.

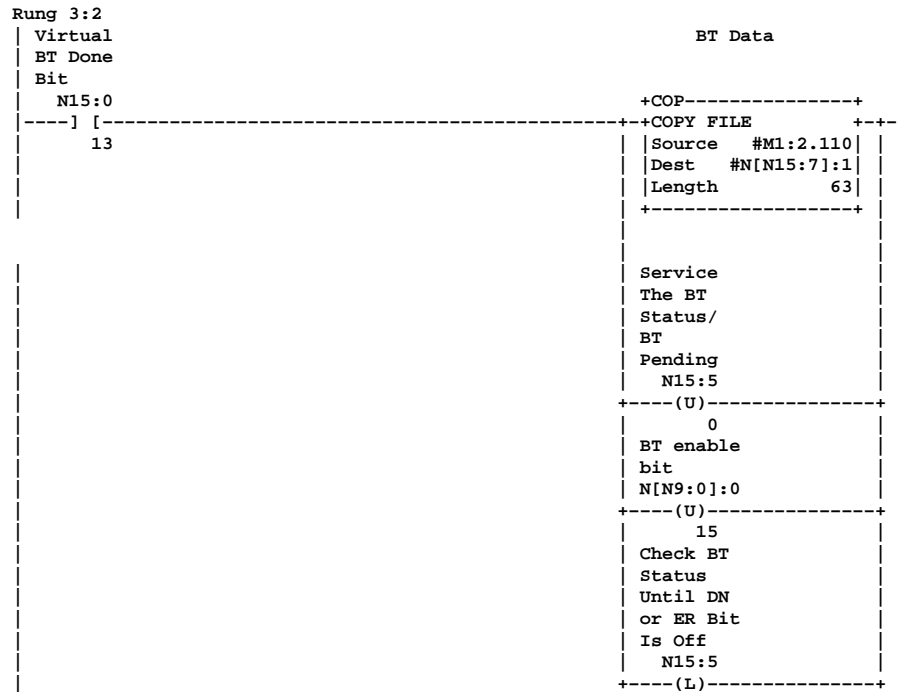

■ **Rung 3:3**

If a BTR error occurs, unlatch the enable bit and buffer the BT error code. Also, unlatch the BTR pending bit, latch the bit that continues checking the BTR status until the SN module turns off the error bit and latch the control word error bit.

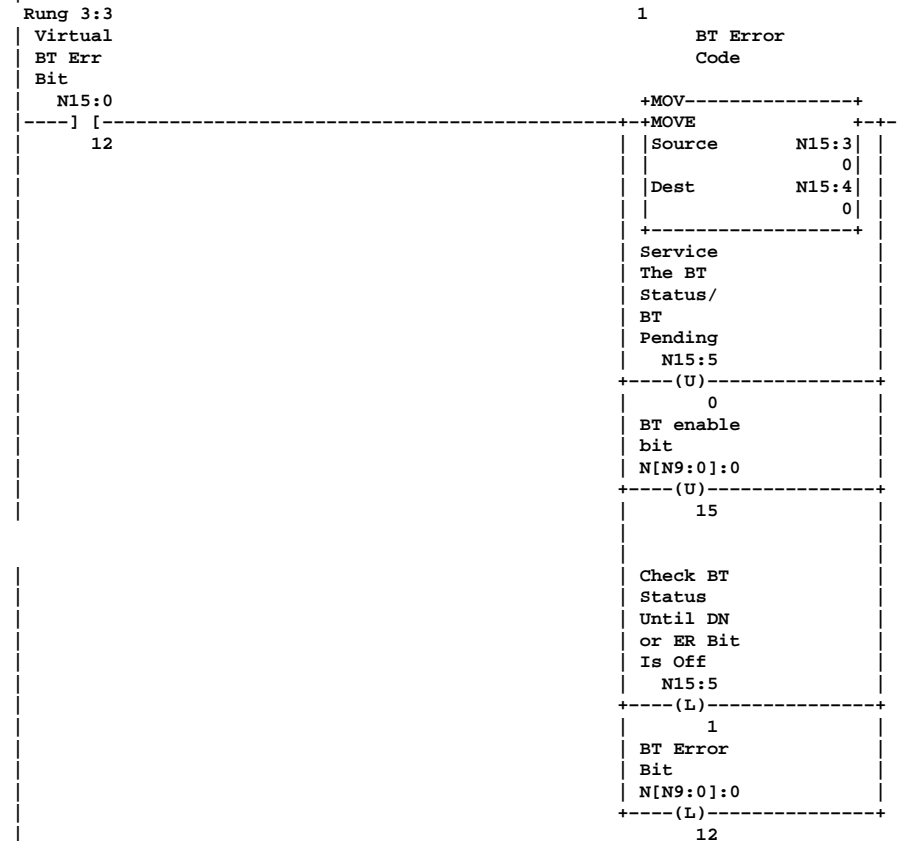

Rung 3:4

When a new BTR is initiated, latch the enable bit, as long as a BTR is not in progress. Also, latch the BTR pending bit, so the BTR status file will be BTR by the ladder program. Because this rung marks the beginning of the BTR, both the done and error bits for the block transfer control word are unlatched along with the block transfer initiate bit.

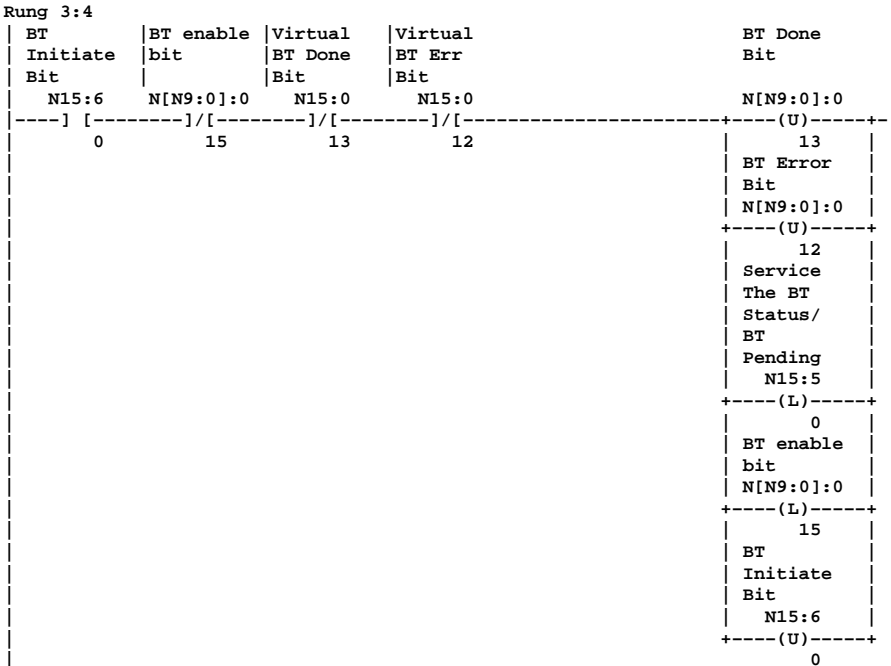

Rung 3:5

Move the virtual control words to the M0 file for the SN module whenever a transition of the BTR enable bit occurs.

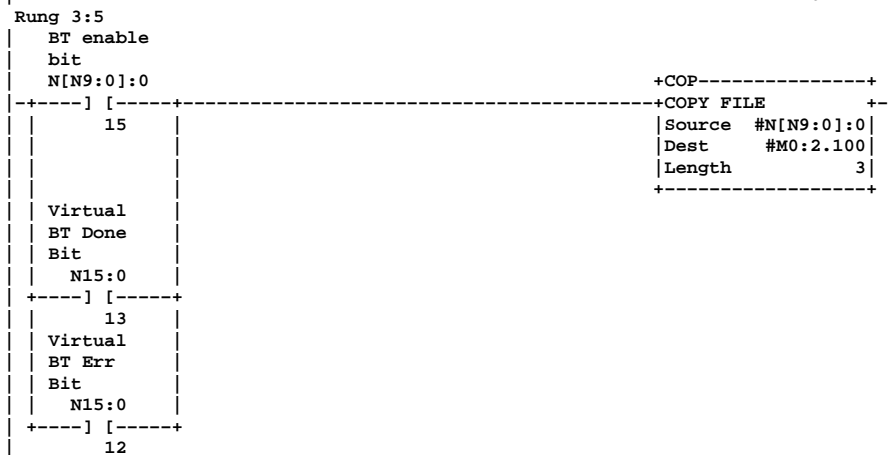

Rung 3:6

If all the conditions of this rung are true, the BTR cycle is complete. Latch the control word done bit if the error word at N15:4 is clear, or the control word error bit if it is not.

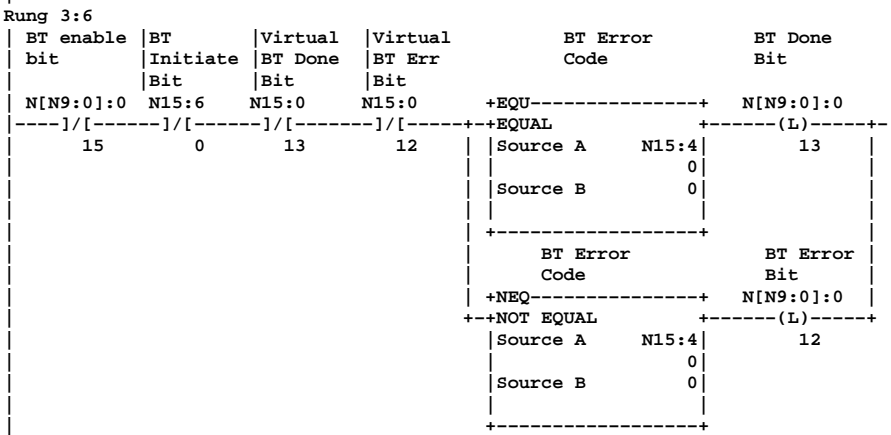

Rung 3:7

Return from subroutine.



Rung 3:8

End of file.

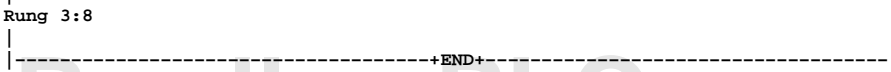

### BTW ( File 4 )

#### Rung 4:0

Copy the BTW status area to a file which will be used throughout the program, only when a BTW is pending. This avoids accessing the M1 file multiple times during each scan. Each time an instruction containing an M1 file bit, word or file is scanned by the processor, an immediate data transfer to the module occurs and therefore will impact the processor scan time.

#### Rung 4:1

Unlatch the bit that continues to check the BTW status. When a BTW is complete, the done bit is set. The ladder must then unlatch the enable bit, then wait for the SN module to turn off the done bit before another BTW to the same M-file location can be initialized.

#### Rung 4:2

When a BTW successfully completes, unlatch the BTW enable bit. Also, unlatch the BTW pending bit and unlatch the bit that continues checking the BTW status until the SN module turns off the done bit.

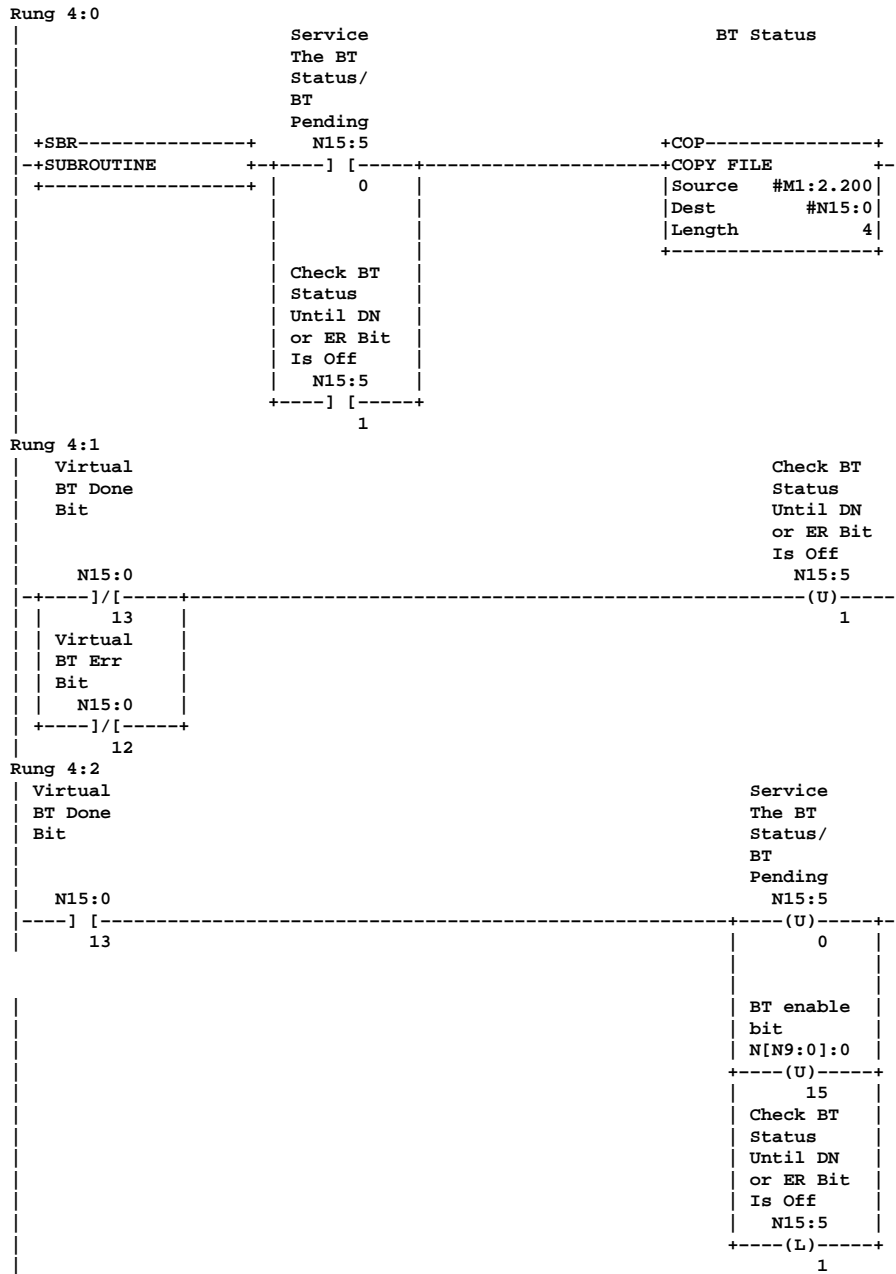

**Rung 4:3**

If a BTW errors, unlatch the enable bit, the BTW pending bit and buffer the BTW error code. Also, latch the bit that continues checking the BTW status until the SN module turns off the error bit and latch the control word error bit.

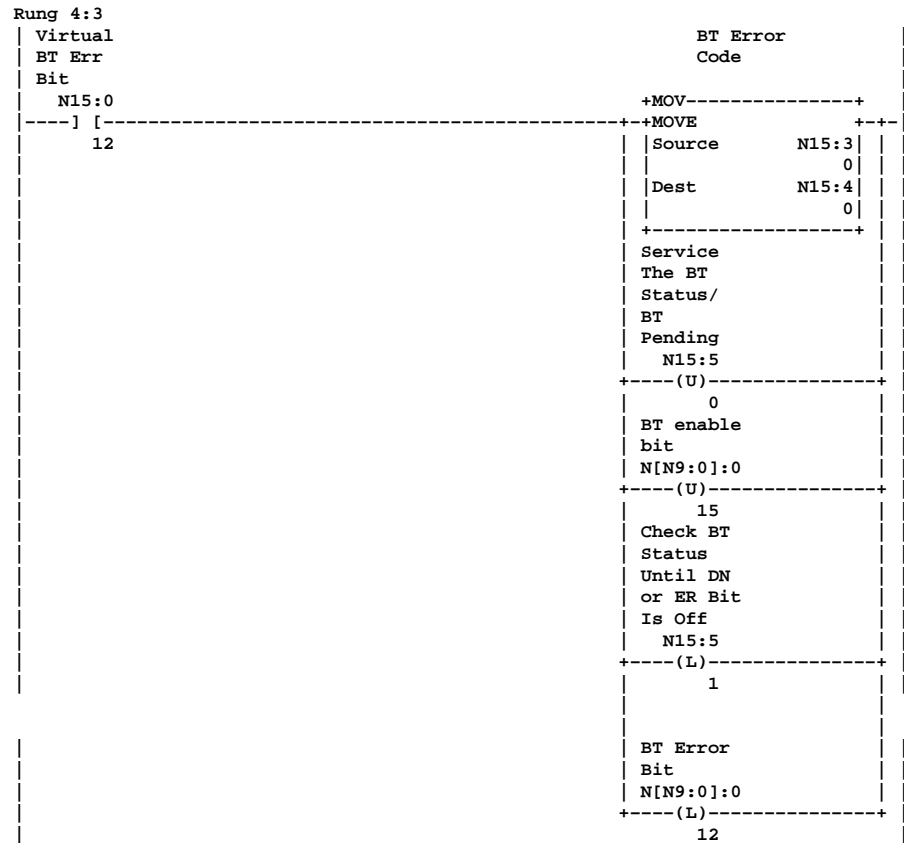
**Rung 4:4**

When a new BTW is initiated, copy the data to the M0 file data area and latch the virtual BTW enable bit provided that a BTW is not in progress. As shown, only 63 words of the BTW data file are copied to the M file buffer, beginning at word 1, in order to match the Powermonitor II data table layout. Also, latch the BTW pending bit, so the BT status file will be read by the ladder program. And because this rung marks the beginning of the BTW, unlatch the control word done and error bits and the BT initiate bit.

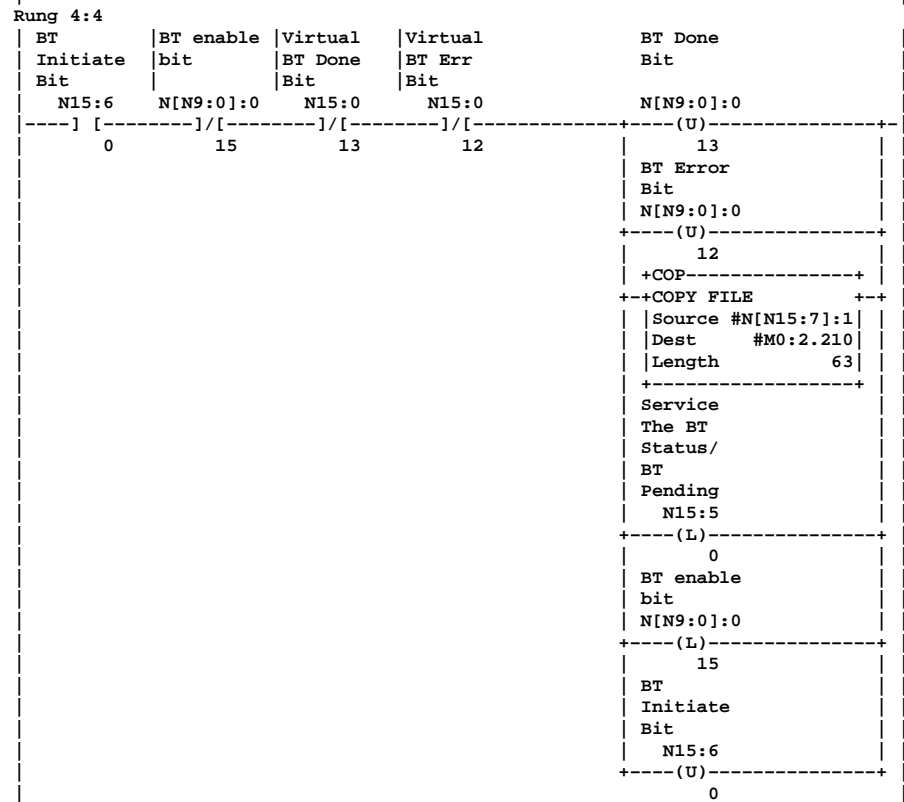

**Rung 4:5**

Move the virtual control words to the M0 file for the SN module whenever a transition of the BTW enable bit occurs.

```

Rung 4:5
BT enable
bit
N[N9:0]:0
-----] [-----+-----+
|      15      |                                     | +COP-----+
|                                     | +COPY FILE  +
| Virtual      | | Source #N[N9:0]:0 |
| BT Done     | | Dest  #M0:2.200 |
| Bit         | | Length      3 |
| N15:0       | |-----+-----+
+-----] [-----+
|      13      |
| Virtual      |
| BT Err       |
| Bit         |
| N15:0       |
+-----] [-----+
|      12      |

```

**Rung 4:6**

If all the conditions of this rung are true, the BTW cycle is complete. Latch the control word done bit if the error word at N15:4 is clear, or the control word error bit if it is not.

```

Rung 4:6
BT enable |BT      |Virtual |Virtual |   BT Error   |   BT Done
bit       |Initiate|BT Done |BT Err  |   Code       |   Bit
          |Bit     |Bit     |Bit     |              |
N[N9:0]:0 N15:6 N15:0 N15:0  +EQU-----+ N[N9:0]:0
-----]/[-----]/[-----]/[-----]+-----+-----+
|      15      |   0   |   13   |   12   | | Source A   N15:4 |   13   |
|                                     |   0   |                                     |
|                                     | Source B   0 |                                     |
|                                     |-----+-----+
|                                     |   BT Error   |   BT Error
|                                     |   Code       |   Bit
|                                     | +NEQ-----+ N[N9:0]:0
+-----+NOT EQUAL-----+-----+-----+
| Source A   N15:4 |   12   |
|   0   |
| Source B   0 |
|-----+-----+

```

**Rung 4:7**

Return from subroutine.

```

Rung 4:7
-----+-----+
|                                     | +RET-----+
|                                     | +RETURN-----+
|                                     |-----+-----+

```

**Rung 4:8**

End of file.

```

Rung 4:8
-----+-----+
|                                     | +END+
|-----+-----+

```



**BT Preparation ( File 5 )**

**Rung 5:0**

In preparation for execution of a block transfer, this rung clears the 8 words of file N15, moves the BT data table location into word N15:7, latches the BT initiate bit and unlatches the BT enable bit.

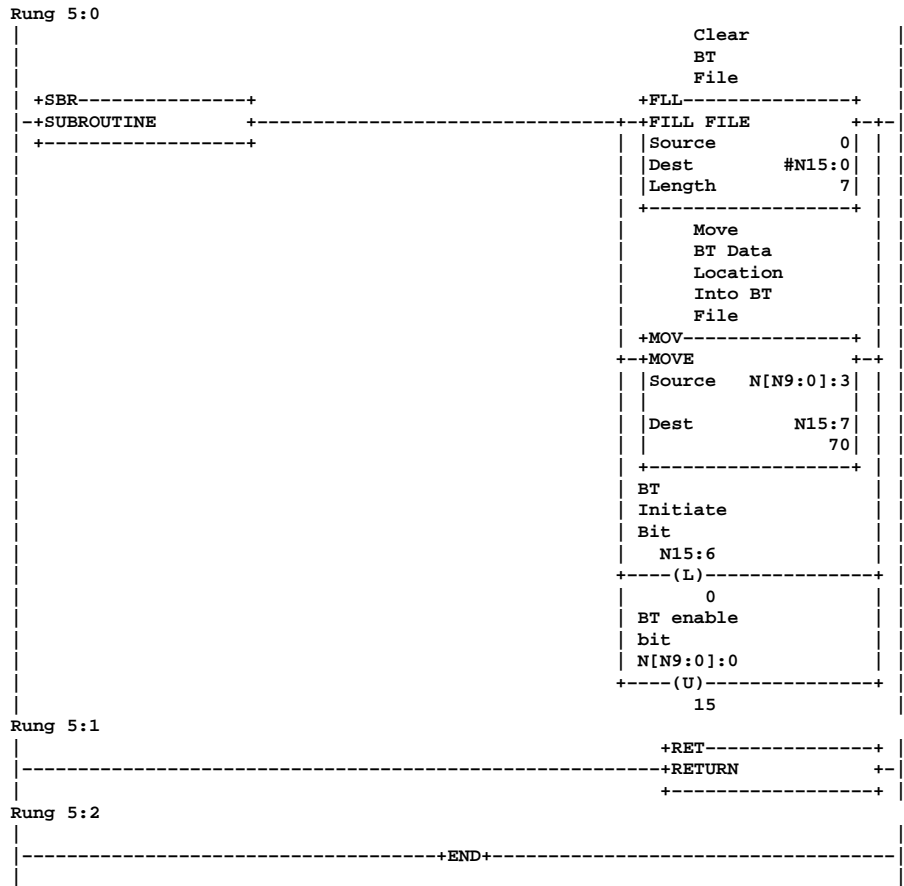

**Rung 5:1**

Return from subroutine.

**Rung 5:2**

End of file.

**SLC-500 RS-232**

**Rung 2:0**

Latch configuration mode and unlatch setpoint and run modes. Clear one-shot bits.

```

Rung 2:0
      Enable configuration mode and clear one shot bits.
First      Config
Pass      Mode
S:1      B3
] [-----] (L)-----
      15
      |
      | Setpoint
      | Mode
      | B3
      |----- (U)-----
      | 1
      | Run
      | Mode
      | B3
      |----- (U)-----
      | 2
      | Clear
      | One Shots
      |-----+
      | +CLR-----+
      | +CLEAR      +
      | |Dest      B3:18|
      | | 0100000000000000|
      | |-----+
      | | +CLR-----+
      | | +CLEAR      +
      | | |Dest      B3:19|
      | | | 0000000000000000|
      | |-----+
      | |-----+
  
```

**Rung 2:1**

Initialize the sequencer for configuration mode. This includes loading the sequencer input file with the configuration block transfer numbers, setting the sequencer length, clearing the sequencer position and moving the reset word into the sequencer's output file.

```

Rung 2:1
      Initialize for appropriate mode.
First      Initialize
Pass      Sequencer
          Input File
S:1      +COP-----+
] [-----] +COPY FILE +
      15
      |
      | |Source  #N11:0|
      | |Dest   #N10:0|
      | |Length  3|
      | |-----+
      |
      | Initialize
      | Sequencer
      | Length
      |-----+
      | +MOV-----+
      | +MOVE      +
      | |Source    2|
      | |Dest     R6:0.LEN|
      | |      1|
      | |-----+
      |
      | Initialize
      | Sequencer
      | Position
      |-----+
      | +CLR-----+
      | +CLEAR      +
      | |Dest     R6:0.POS|
      | |      1|
      | |-----+
      |
      | Initialize
      | Sequencer
      | Address
      |-----+
      | +MOV-----+
      | +MOVE      +
      | |Source    N10:0|
      | |      40|
      | |Dest     N9:0|
      | |      40|
      | |-----+
  
```

**Rung 2:2**

If the configuration BTW and diagnostic BTR are done, check that the diagnostic table parameters indicate a successful BTW (word 36 and 37 equal 0). If so, unlatch the configuration mode bit and latch the setpoint mode bit.

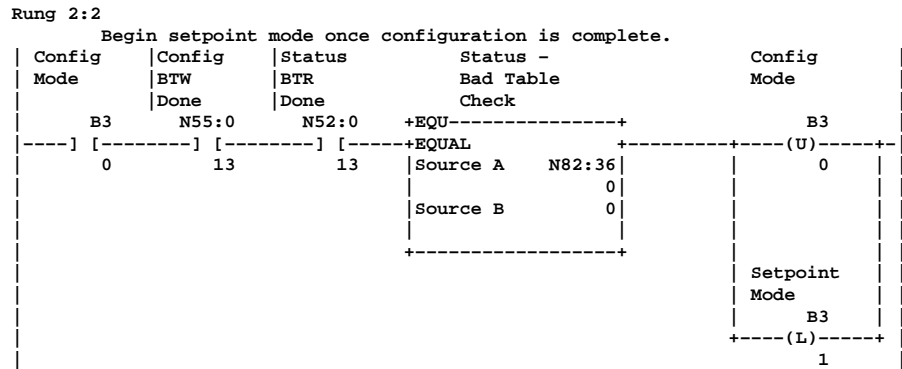

**Rung 2:3**

Initialize the sequencer for setpoint mode. Same functionality as Rung 2:0.

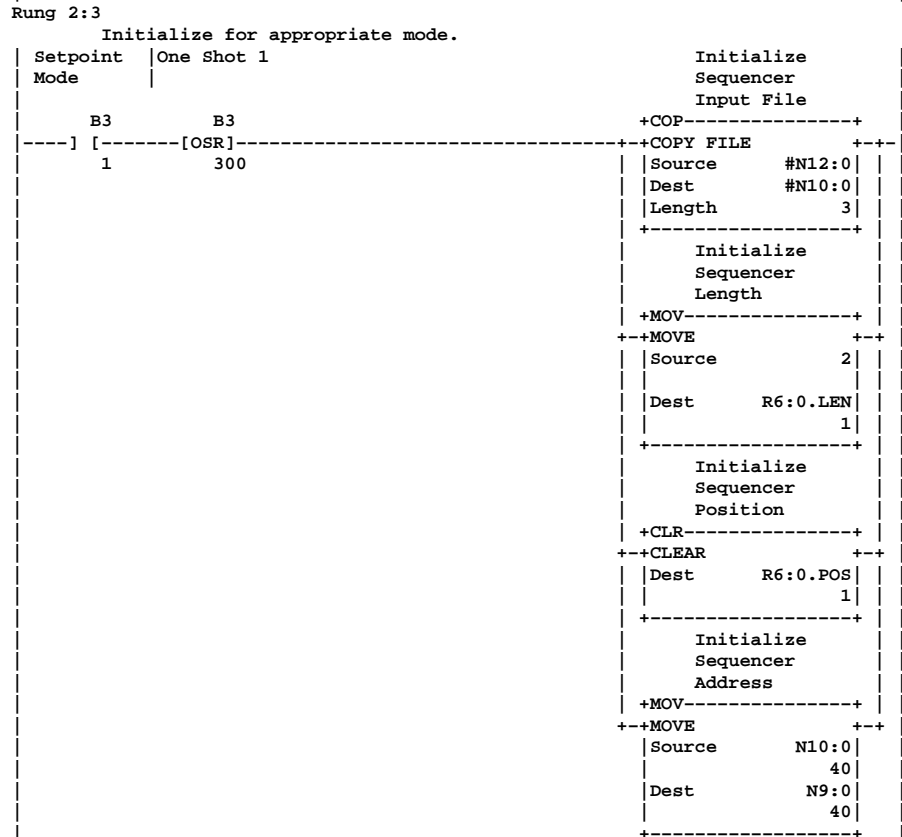

**Rung 2:4**

Move the number of setpoints into the setpoint address counter. Reset the setpoint counter.

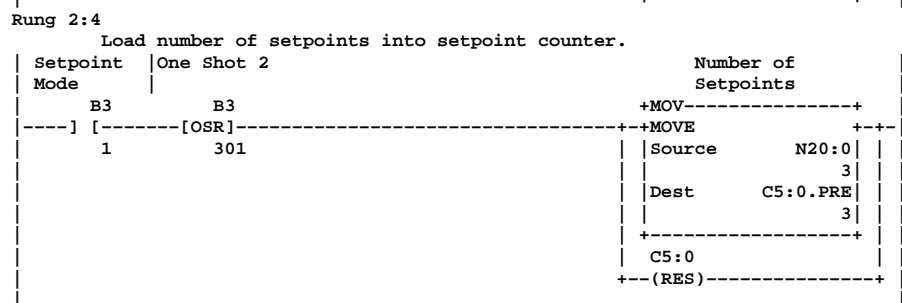

**Rung 2:5**

Initialize the sequencer for run mode. Same functionality as rungs 2:0 and 2:1.

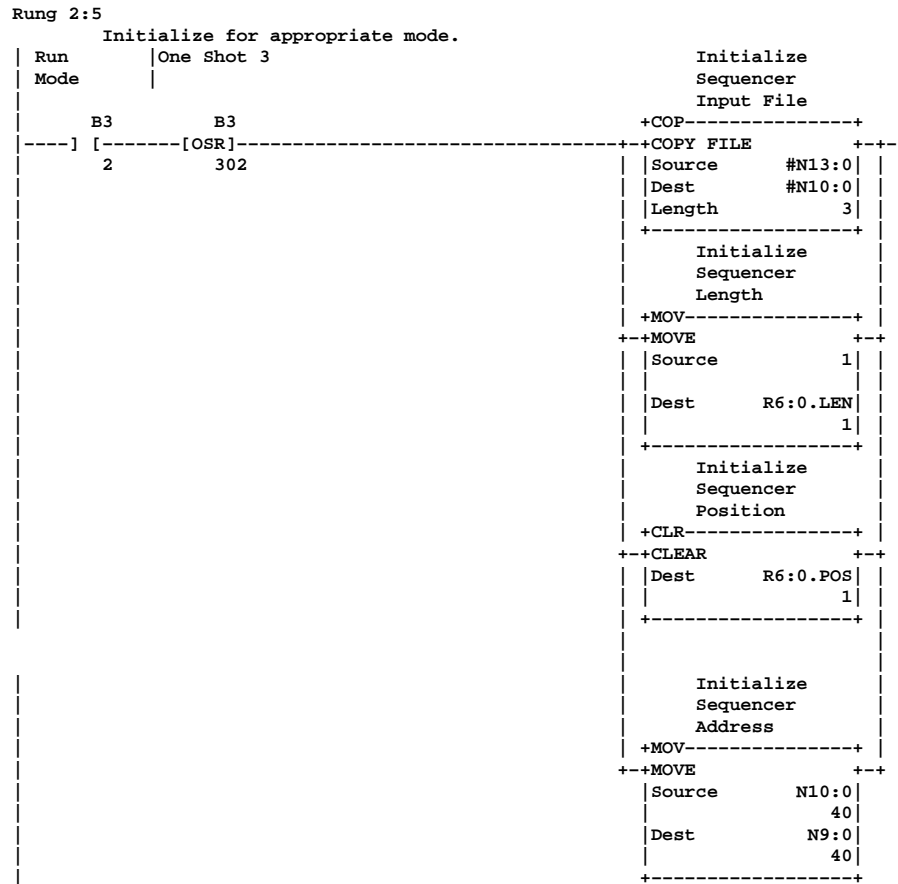

**Rung 2:6**

This is the main block transfer sequencer. The sequencer output word, N9:0, is updated whenever the previous block transfer is done or fails.

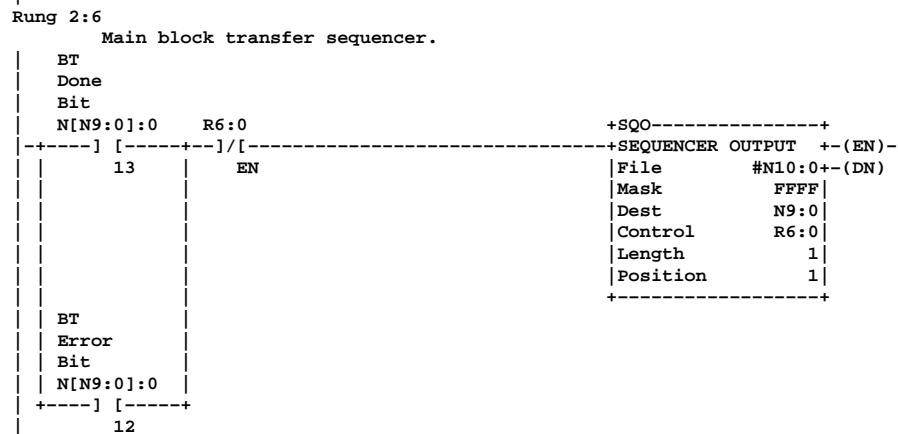

**Rung 2:7**

Voltage/current BTR.

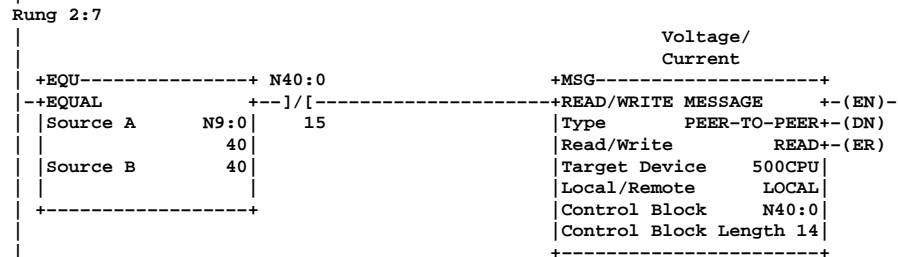

**Rung 2:8**

Real time power BTR.

```

Rung 2:8
+-----+
| +EQU-----+ N41:0
| +EQUAL      +---] / [-----+
| |Source A   N9:0| 15
| |           40 |
| |Source B   41 |
| +-----+
|
|                                     real time
|                                     Power
| +-----+
| +MSG-----+
| +READ/WRITE MESSAGE  +--(EN)-
| |Type      PEER-TO-PEER+--(DN)
| |Read/Write      READ+--(ER)
| |Target Device   500CPU|
| |Local/Remote    LOCAL|
| |Control Block   N41:0|
| |Control Block Length 14|
| +-----+
    
```

**Rung 2:9**

Cumulative power BTR.

```

Rung 2:9
+-----+
| +EQU-----+ N42:0
| +EQUAL      +---] / [-----+
| |Source A   N9:0| 15
| |           40 |
| |Source B   42 |
| +-----+
|
|                                     Cumulative
|                                     Power
| +-----+
| +MSG-----+
| +READ/WRITE MESSAGE  +--(EN)-
| |Type      PEER-TO-PEER+--(DN)
| |Read/Write      READ+--(ER)
| |Target Device   500CPU|
| |Local/Remote    LOCAL|
| |Control Block   N42:0|
| |Control Block Length 14|
| +-----+
    
```

**Rung 2:10**

Device configuration BTR.

```

Rung 2:10
+-----+
| +EQU-----+ N43:0
| +EQUAL      +---] / [-----+
| |Source A   N9:0| 15
| |           40 |
| |Source B   43 |
| +-----+
|
|                                     Device
|                                     Config
| +-----+
| +MSG-----+
| +READ/WRITE MESSAGE  +--(EN)-
| |Type      PEER-TO-PEER+--(DN)
| |Read/Write      READ+--(ER)
| |Target Device   500CPU|
| |Local/Remote    LOCAL|
| |Control Block   N43:0|
| |Control Block Length 14|
| +-----+
    
```

**Rung 2:11**

Communication configuration BTR.

```

Rung 2:11
+-----+
| +EQU-----+ N44:0
| +EQUAL      +---] / [-----+
| |Source A   N9:0| 15
| |           40 |
| |Source B   44 |
| +-----+
|
|                                     Comm.
|                                     Config
| +-----+
| +MSG-----+
| +READ/WRITE MESSAGE  +--(EN)-
| |Type      PEER-TO-PEER+--(DN)
| |Read/Write      READ+--(ER)
| |Target Device   500CPU|
| |Local/Remote    LOCAL|
| |Control Block   N44:0|
| |Control Block Length 14|
| +-----+
    
```

**Rung 2:12**

Demand BTR.

```

Rung 2:12
+-----+
| +EQU-----+ N45:0
| +EQUAL      +---] / [-----+
| |Source A   N9:0| 15
| |           40 |
| |Source B   45 |
| +-----+
|
|                                     Demand
| +-----+
| +MSG-----+
| +READ/WRITE MESSAGE  +--(EN)-
| |Type      PEER-TO-PEER+--(DN)
| |Read/Write      READ+--(ER)
| |Target Device   500CPU|
| |Local/Remote    LOCAL|
| |Control Block   N45:0|
| |Control Block Length 14|
| +-----+
    
```

**Rung 2:13**

Even harmonic distortion BTR.

```

Rung 2:13
+-----+
| +EQU-----+ N46:0
| +EQUAL      +---] / [-----+
| |Source A   N9:0| 15
| |           40 |
| |Source B   46 |
| +-----+
|
|                                     Even
|                                     Harmonic
|                                     Distortion
| +-----+
| +MSG-----+
| +READ/WRITE MESSAGE  +--(EN)-
| |Type      PEER-TO-PEER+--(DN)
| |Read/Write      READ+--(ER)
| |Target Device   500CPU|
| |Local/Remote    LOCAL|
| |Control Block   N46:0|
| |Control Block Length 14|
| +-----+
    
```

**Rung 2:14**

Odd harmonic distortion BTR.

```

Rung 2:14
                                     Odd
                                     Harmonic
                                     Distortion
+-----+-----+ N47:0
+EQU-----+-----+
|Source A   N9:0| 15 |-----+-----+
|         40 |   |-----+-----+
|Source B   47 |   |-----+-----+
+-----+-----+
                                     +MSG-----+
                                     |READ/WRITE MESSAGE  +- (EN)-
                                     |Type      PEER-TO-PEER+- (DN)
                                     |Read/Write      READ+- (ER)
                                     |Target Device   500CPU|
                                     |Local/Remote    LOCAL|
                                     |Control Block   N47:0|
                                     |Control Block Length 14|
                                     +-----+

```

**Rung 2:15**

Even harmonic magnitude BTR.

```

Rung 2:15
                                     Even
                                     Harmonic
                                     Magnitude
+-----+-----+ N48:0
+EQU-----+-----+
|Source A   N9:0| 15 |-----+-----+
|         40 |   |-----+-----+
|Source B   48 |   |-----+-----+
+-----+-----+
                                     +MSG-----+
                                     |READ/WRITE MESSAGE  +- (EN)-
                                     |Type      PEER-TO-PEER+- (DN)
                                     |Read/Write      READ+- (ER)
                                     |Target Device   500CPU|
                                     |Local/Remote    LOCAL|
                                     |Control Block   N48:0|
                                     |Control Block Length 14|
                                     +-----+

```

**Rung 2:16**

Odd harmonic magnitude BTR.

```

Rung 2:16
                                     Odd
                                     Harmonic
                                     Magnitude
+-----+-----+ N49:0
+EQU-----+-----+
|Source A   N9:0| 15 |-----+-----+
|         40 |   |-----+-----+
|Source B   49 |   |-----+-----+
+-----+-----+
                                     +MSG-----+
                                     |READ/WRITE MESSAGE  +- (EN)-
                                     |Type      PEER-TO-PEER+- (DN)
                                     |Read/Write      READ+- (ER)
                                     |Target Device   500CPU|
                                     |Local/Remote    LOCAL|
                                     |Control Block   N49:0|
                                     |Control Block Length 14|
                                     +-----+

```

**Rung 2:17**

Even harmonic phase BTR.

```

Rung 2:17
                                     Even
                                     Harmonic
                                     Phase
+-----+-----+ N50:0
+EQU-----+-----+
|Source A   N9:0| 15 |-----+-----+
|         40 |   |-----+-----+
|Source B   50 |   |-----+-----+
+-----+-----+
                                     +MSG-----+
                                     |READ/WRITE MESSAGE  +- (EN)-
                                     |Type      PEER-TO-PEER+- (DN)
                                     |Read/Write      READ+- (ER)
                                     |Target Device   500CPU|
                                     |Local/Remote    LOCAL|
                                     |Control Block   N50:0|
                                     |Control Block Length 14|
                                     +-----+

```

**Rung 2:18**

Odd harmonic phase BTR.

```

Rung 2:18
                                     Odd
                                     Harmonic
                                     Phase
+-----+-----+ N51:0
+EQU-----+-----+
|Source A   N9:0| 15 |-----+-----+
|         40 |   |-----+-----+
|Source B   51 |   |-----+-----+
+-----+-----+
                                     +MSG-----+
                                     |READ/WRITE MESSAGE  +- (EN)-
                                     |Type      PEER-TO-PEER+- (DN)
                                     |Read/Write      READ+- (ER)
                                     |Target Device   500CPU|
                                     |Local/Remote    LOCAL|
                                     |Control Block   N51:0|
                                     |Control Block Length 14|
                                     +-----+

```

**Rung 2:19**

Diagnostic BTR.

```

Rung 2:19
                                     Diagnostic
+-----+-----+ N52:0
+EQU-----+-----+
|Source A   N9:0| 15 |-----+-----+
|         40 |   |-----+-----+
|Source B   52 |   |-----+-----+
+-----+-----+
                                     +MSG-----+
                                     |READ/WRITE MESSAGE  +- (EN)-
                                     |Type      PEER-TO-PEER+- (DN)
                                     |Read/Write      READ+- (ER)
                                     |Target Device   500CPU|
                                     |Local/Remote    LOCAL|
                                     |Control Block   N52:0|
                                     |Control Block Length 14|
                                     +-----+

```

**Rung 2:20**

Relay/setpoint BTR.

```

Rung 2:20
+-----+
+EQU-----+ N53:0
+-----+
+EQUAL          +---] / [-----+
|Source A      N9:0 | 15
|              40 |
|Source B      53 |
+-----+
+-----+
+MSG-----+
+-----+
+READ/WRITE MESSAGE  +-(EN)-
|Type              PEER-TO-PEER+-(DN)-
|Read/Write        READ+-(ER)
|Target Device     500CPU|
|Local/Remote      LOCAL|
|Control Block     N53:0|
|Control Block Length 14|
+-----+
    
```

**Rung 2:21**

Command BTW.

```

Rung 2:21
+-----+
+EQU-----+ N54:0
+-----+
+EQUAL          +---] / [-----+
|Source A      N9:0 | 15
|              40 |
|Source B      54 |
+-----+
+-----+
+MSG-----+
+-----+
+READ/WRITE MESSAGE  +-(EN)-
|Type              PEER-TO-PEER+-(DN)-
|Read/Write        WRITE+-(ER)
|Target Device     500CPU|
|Local/Remote      LOCAL|
|Control Block     N54:0|
|Control Block Length 14|
+-----+
    
```

**Rung 2:22**

Configuration BTW.

```

Rung 2:22
+-----+
+EQU-----+ N55:0
+-----+
+EQUAL          +---] / [-----+
|Source A      N9:0 | 15
|              40 |
|Source B      55 |
+-----+
+-----+
+MSG-----+
+-----+
+READ/WRITE MESSAGE  +-(EN)-
|Type              PEER-TO-PEER+-(DN)-
|Read/Write        WRITE+-(ER)
|Target Device     500CPU|
|Local/Remote      LOCAL|
|Control Block     N55:0|
|Control Block Length 14|
+-----+
    
```

**Rung 2:23**

If the setpoint counter done bit is set, the last setpoint BTW has occurred and was followed by a diagnostic BTR. If the diagnostic table indicates a successful setpoint BTW, setpoint mode is done. The setpoint mode bit is unlatched, and the run mode bit is latched.

```

Rung 2:23
Begin run mode once all setpoint block transfers are complete.
          One Shot 4      Status -      Setpoint      Setpoint
          Bad Table      Check          Counter      Mode
          [OSR]-----+
+-----+ B3 +EQU-----+ C5:0 B3
+-----+ [OSR]-----+ [-----] [-----] (U)-----+
|Source A      N9:0 | 303 |Source A      N82:36 | DN | 1
|              40 |         |Source B          0 |   |
|Source B      56 |         |Source B          0 |   |
+-----+         +-----+
          Run
          Mode
          B3
          (L)-----+
          2
    
```

Rung 2:24

This rung is activated once when the sequencer output file changes to setpoint BTW. Its purpose is to determine the address of the next setpoint data and to copy the data residing at this address into the setpoint BTW data location. This is accomplished by first adding an address offset to a base address to determine the location of the next setpoint data. The data residing at the resulting address is then transferred to the setpoint BTW data location. A counter is used to determine the address offset. Prior to the first setpoint BTW, the counter is automatically incremented. For subsequent setpoint BTWs, the counter is incremented when the diagnostic table BTR for the previous setpoint BTW is successful. For example, the 3rd setpoint will reside at base address 24. In this case, a counter value of 3 will be added to the base address 21. The data residing at location 24 will then be transferred into the setpoint BTW data location N86:1.

Rung 2:24

```
Load next setpoint into setpoint write data.
One Shot 5
Status - Setpoint Setpoint
Bad Table Counter Number
Check Done Bit
+EQU-----+ B3 +EQU-----+ C5:0 +CTU-----+
+---[OSR]--+---+---+-----+---+---+-----+---+---+---+
|Source A N9:0| 304 | |Source A N82:36| |DN| Counter C5:0+-(DN) | | | |
| | 40| | | | 0| | |Preset 3| |
|Source B 56| | |Source B 0| | |Accum 3| |
+-----+ +-----+
Prepare
Initial
Setpoint
Write
+EQU-----+
+---+-----+---+
|Source A C5:0.ACC|
| | 3|
|Source B 0|
+-----+
Setpoint
Data
Address
+ADD-----+
+---+-----+---+
|Source A 21|
|Source B C5:0.ACC|
| | 3|
|Dest N20:1|
| | 24|
+-----+
Move
Current
Setpoint
Data into
BTW Table
+COP-----+
+---+-----+---+
|Source #N[N20:1]:1|
|Dest #N86:1|
|Length 20|
+-----+
```

Rung 2:25

Setpoint BTW.

Rung 2:25

```
Setpoint
+EQU-----+ N56:0 +MSG-----+
+---+-----+---+---+-----+---+---+-----+---+---+---+
|Source A N9:0| 15 |READ/WRITE MESSAGE +- (EN)- | |
| | 40| |Type PEER-TO-PEER+-(DN) |
|Source B 56| |Read/Write WRITE+-(ER) |
| | |Target Device 500CPU|
| | |Local/Remote LOCAL|
| | |Control Block N56:0 |
| | |Control Block Length 14|
+-----+ +-----+
```

Rung 2:26

End of file.

Rung 2:26

```
+-----+ +-----+
+---+-----+---+
| | | |
+-----+ +-----+
+---+-----+---+
| | | |
+-----+ +-----+
```



## Technical Specifications

### Product Approvals

UL 508 Component Recognized File E96956 and CSA C22.2 approval for Industrial Control Equipment.

### Compliance to European Union Directives

If this product has the CE mark it is approved for installation within the European Union and EEA regions. It has been designed and tested to meet the following directives.

#### EMC Directive

This product is tested to meet Council Directive 89/336/EEC Electromagnetic Compatibility (EMC) and the following standards, in whole or in part, documented in a technical construction file:

- EN 50081-2 – Generic Emission Standard, Part 2 – Industrial Environment
- EN 50082-2 – Generic Immunity Standard, Part 2 – Industrial Environment

This product is intended for use in an industrial environment.

#### Low Voltage Directive

This product is tested to meet Council Directive 73/23/EEC Low Voltage, by applying the safety requirements of IEC 1010-1.

This equipment is classified as open equipment and must be installed (mounted) in an enclosure during operation as a means of providing safety protection.

### Screw Torque and Wire Size

Position	Ratings
Mounting Screw Tightening Torque	0.9 to 1.1 Nm (8 to 10 lb-in.)
Communications Connector	0.6 to 0.8 Nm (8 to 10 lb-in.)
Terminal Screw Tightening Torque	0.2 to 2.5 mm <sup>2</sup> (24-12 AWG), stranded or solid wire, Cu wire only.
Terminal Block/Wire Insulation Temperature Index	75° C maximum

### Environmental Specifications

Operating Temperature	–40° C to +60° C
Storage Temperature	–40° C to +85° C
Humidity	5 to 95 percent, non-condensing
Vibration	Operational: 0.006 in. DA/1.0 G Sine, 10 to 500 Hz, 3 orthogonal axes.
	Non-operational: 0.015 in. DA/2.5 G Sine, 10 to 500 Hz, 3 orthogonal axes.
Shock	Operational: 15 G, Half Sine, 11 ms duration, 3 orthogonal axes, 3 (+) and 3 (–) pulses/axes, 18 pulses total.
	Non-operational: 30 G, Half Sine, 11 ms duration, 3 orthogonal axes, 3 (+) and 3 (–) pulses/axes, 18 pulses total.





Allen-Bradley, a Rockwell Automation Business, has been helping its customers improve productivity and quality for more than 90 years. We design, manufacture and support a broad range of automation products worldwide. They include logic processors, power and motion control devices, operator interfaces, sensors and a variety of software. Rockwell is one of the world's leading technology companies.

### Worldwide representation.



Argentina • Australia • Austria • Bahrain • Belgium • Brazil • Bulgaria • Canada • Chile • China, PRC • Colombia • Costa Rica • Croatia • Cyprus • Czech Republic • Denmark • Ecuador • Egypt • El Salvador • Finland • France • Germany • Greece • Guatemala • Honduras • Hong Kong • Hungary • Iceland • India • Indonesia • Ireland • Israel • Italy • Jamaica • Japan • Jordan • Korea • Kuwait • Lebanon • Malaysia • Mexico • Netherlands • New Zealand • Norway • Pakistan • Peru • Philippines • Poland • Portugal • Puerto Rico • Qatar • Romania • Russia-CIS • Saudi Arabia • Singapore • Slovakia • Slovenia • South Africa, Republic • Spain • Sweden • Switzerland • Taiwan • Thailand • Turkey • United Arab Emirates • United Kingdom • United States • Uruguay • Venezuela • Yugoslavia

Allen-Bradley Headquarters, 1201 South Second Street, Milwaukee, WI 53204 USA, Tel: (1) 414 382-2000 Fax: (1) 414 382-4444

# Allen-Bradley PLCs