



SHUNT TRIP DÉCLENCHEUR SHUNT ARBEITSSTROMAUSLÖSER SGANCIATORE DI APERTURA CONMUTADOR REMOTO

(Cat 1489-AASTA1, -AASTA2)



ATTENTION: To prevent electrical shock, disconnect from power source before installing or servicing.

ATTENTION: Avant le montage et la mise en service, couper l'alimentation secteur pour éviter toutes décharges.





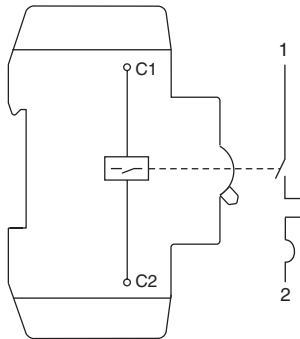

ACHTUNG: Vor Installations- oder Servicearbeiten Stromversorgung unterbrechen, um Elektroschocks zu vermeiden.

ATTENZIONE: Per prevenire infortuni, togliere tensione prima dell'installazione o manutenzione.

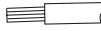
ATENCIÓN: Desconéctese de la corriente eléctrica, antes de la instalación o del servicio, a fin de impedir sacudidas eléctricas.



1489-AAST ...

	Cu  only mm ²	AWG		 		
1489-AAST ...	1 x 1 - 6	1 x #18 - #10	12 mm (.50")	Z2	1.0 x 6.5mm (.040 x .25 in)	2.8 Nm (25 lb-in)
	2 x 1 - 2 x 6	2 x #18 - 2 x #10				

Allowable Combinations and Positions
Combinaisons et Positions Possible
Zulaessige Kombinationen und Positionen
Combinazioni e Posizioni Accettabili
Combinaciones y Posiciones Válidas

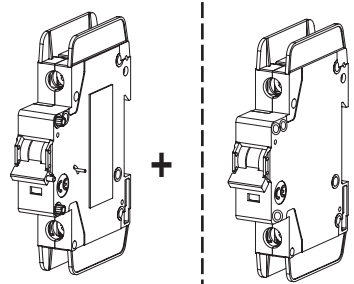

Maximum
 Massimo
 Máximo

1489-AAHH3	1489-AAHS3	1489-AAST...	1489-A...
X			X
	X		X
		X	X
X		X	X
	X	X	X

1489-A ... + 1489-AAST ...

