

1769-OV16

1492-IFM20F

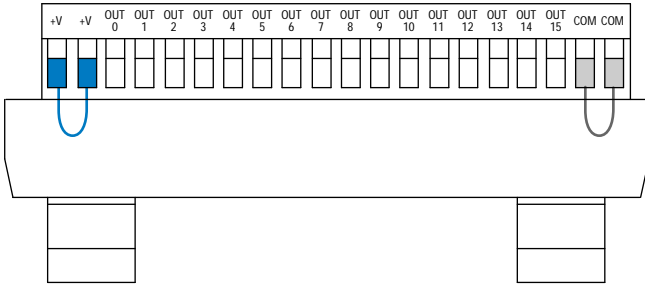

- ① Cables are available in 0.5m, 1.0m, 2.5m and 5.0m standard lengths (005=0.5m, 010=1.0m, 025=2.5m, 050=5.0m). Custom length cables are also available.

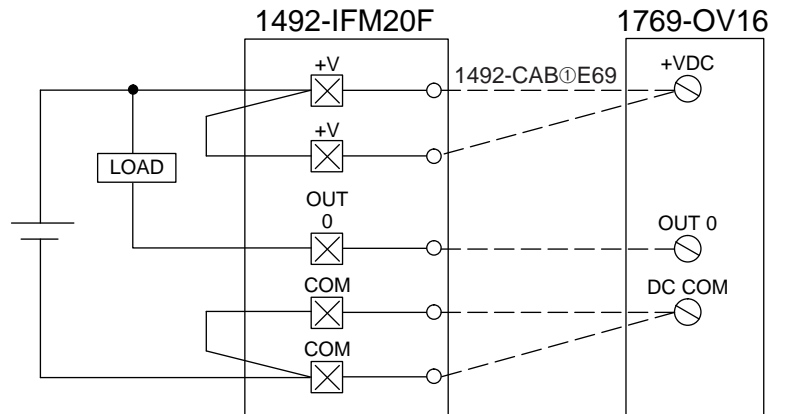

Spare Allen-Bradley Parts

1492 Wiring Diagram Symbology Reference List

 = Required Fieldside Jumper (solid jumper)

 = Optional Fieldside Jumper
[Refer to Application Footnotes.] (dashed jumper)

 = AC Supply

 = DC Supply

 = AC or DC power supply

 = Input Device

 = Three-wire Sinking Input Device

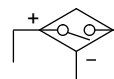
 = Three-wire Sourcing Input Device

 = Three-wire AC Input Device

 = Output Device

 = Fieldside Terminal

 = I/O Module Connection

 = Expander cable connection

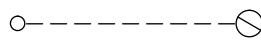
 = 1492 Pre-wired Cable

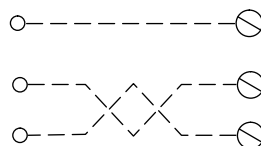
 = 1492 Pre-wired Shielded Cable

 = LED Indicator

 = Fuse with Blown Fuse Indicator

 = Normally closed relay contacts

 = Normally open relay contacts

 = Relay coil

Note: Labels for SLC all shown in decimal - octal also available.