

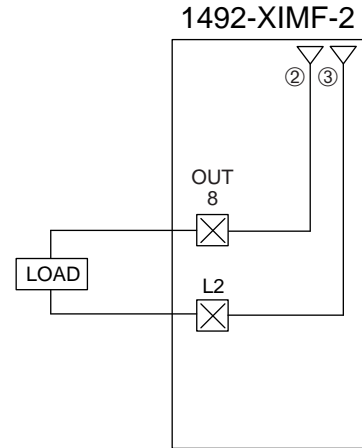

# 1756-OA16, TC-OAD161

1492-XIMF-2

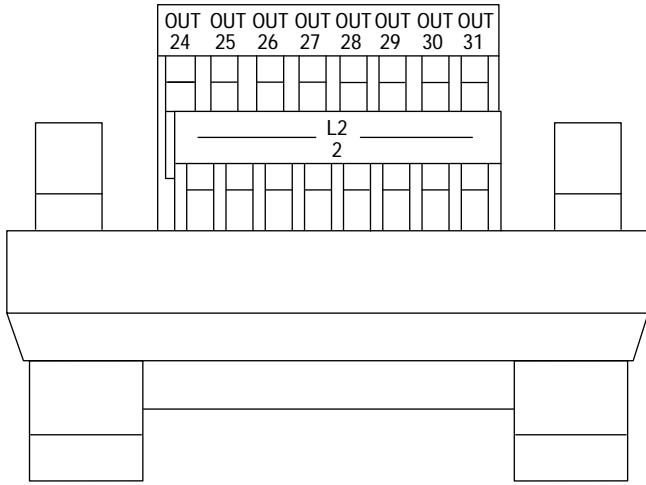

- ② Output control signal from Relay Master.
- ③ Power reference signal from Relay Master.

## 1492 Wiring Diagram Symbology Reference List

 = Required Fieldside Jumper (solid jumper)

 = Optional Fieldside Jumper  
[Refer to Application Footnotes.] (dashed jumper)

 = Three-wire Sinking Input Device

 = Three-wire Sourcing Input Device

 = AC Supply

 = DC Supply

 = Input Device

 = Output Device

 = Fuse with Blown Fuse Indicator

 = Three-wire AC Input Device

 = Fieldside Terminal

 = I/O Module Connection

 = LED Indicator

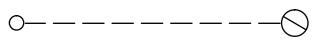
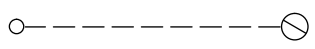
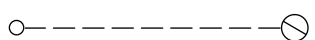
  
 = 1492 Pre-wired Cable  

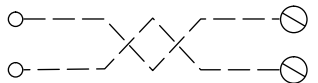
 = 1492 Pre-wired Shielded Cable

 = Normally closed relay contacts

 = Normally open relay contacts

 = Relay coil

 = Expander cable connection

 = AC or DC power supply

Note: Labels for SLC all shown in decimal - octal also available.