

# 1756-OB32, TC-ODD321

## 1492-XIMF-2 ⑤

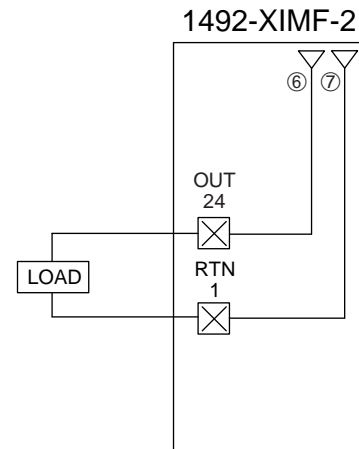
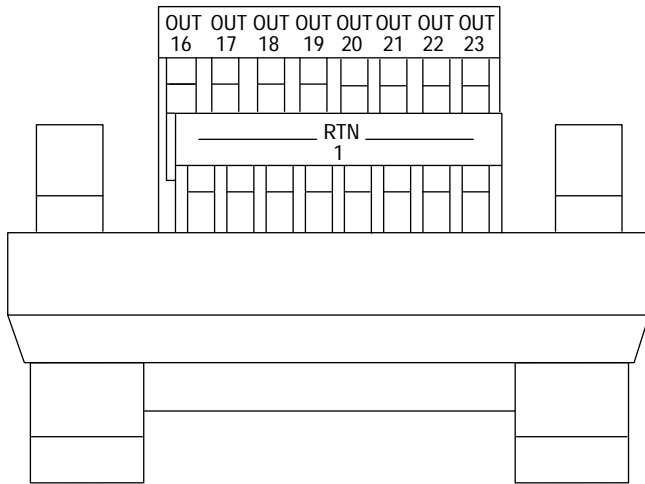

⑤ XIM can also use terminal labels:

OUT OUT OUT OUT OUT OUT OUT OUT upper  
 8 9 10 11 12 13 14 15  
 \_\_\_\_\_ RTN \_\_\_\_\_ lower

OUT OUT OUT OUT OUT OUT OUT OUT upper  
 8 9 10 11 12 13 14 15  
 \_\_\_\_\_ RTN \_\_\_\_\_ lower  
 0

⑥ Output control signal from Relay Master.

⑦ Power reference signal from Relay Master.

## 1492 Wiring Diagram Symbology Reference List

 = Required Fieldside Jumper (solid jumper)

 = Optional Fieldside Jumper  
[Refer to Application Footnotes.] (dashed jumper)

 = Three-wire Sinking Input Device

 = Three-wire Sourcing Input Device

 = AC Supply

 = DC Supply

 = Input Device

 = Output Device

 = Fuse with Blown Fuse Indicator

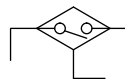
 = Three-wire AC Input Device

 = Fieldside Terminal

 = I/O Module Connection

 = LED Indicator

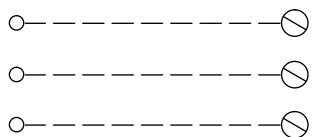
 = 1492 Pre-wired Cable

 = 1492 Pre-wired Shielded Cable

 = Normally closed relay contacts

 = Normally open relay contacts

 = Relay coil

 = Expander cable connection

 = AC or DC power supply

Note: Labels for SLC all shown in decimal - octal also available.