

Installation Instructions

ArmorBlock 16-Point EtherNet/IP Module, Series A

Catalog Numbers 1732E-IB16M12, 1732E-OB16M12,
1732E-16CFGM12, 1732E-16CFGM12W, 1732E-IB16M12W

Topic	Page
Important User Information	2
Environment and Enclosure	3
Prevent Electrostatic Discharge	3
About the EtherNet/IP ArmorBlock 16-Point I/O Modules	4
Catalog Number Explanation	6
Install the Module	6
Set the Network Address	6
Mount the Module	7
Product Dimensions	8
Connect the I/O, Network and Auxiliary Cables to the ArmorBlock Module	9
Specifications	19

AB Spa

Important User Information

Solid state equipment has operational characteristics differing from those of electromechanical equipment. Safety Guidelines for the Application, Installation and Maintenance of Solid State Controls (publication [SGI-1.1](#) available from your local Rockwell Automation sales office or online at <http://literature.rockwellautomation.com>) describes some important differences between solid state equipment and hard-wired electromechanical devices. Because of this difference, and also because of the wide variety of uses for solid state equipment, all persons responsible for applying this equipment must satisfy themselves that each intended application of this equipment is acceptable.





In no event will Rockwell Automation, Inc. be responsible or liable for indirect or consequential damages resulting from the use or application of this equipment.

The examples and diagrams in this manual are included solely for illustrative purposes. Because of the many variables and requirements associated with any particular installation, Rockwell Automation, Inc. cannot assume responsibility or liability for actual use based on the examples and diagrams.

No patent liability is assumed by Rockwell Automation, Inc. with respect to use of information, circuits, equipment, or software described in this manual.

Reproduction of the contents of this manual, in whole or in part, without written permission of Rockwell Automation, Inc., is prohibited.

Throughout this manual, when necessary, we use notes to make you aware of safety considerations.

 WARNING	Identifies information about practices or circumstances that can cause an explosion in a hazardous environment, which may lead to personal injury or death, property damage, or economic loss.
 IMPORTANT	Identifies information that is critical for successful application and understanding of the product.
 ATTENTION	Identifies information about practices or circumstances that can lead to personal injury or death, property damage, or economic loss. Attentions help you to identify a hazard, avoid a hazard, and recognize the consequences.
 SHOCK HAZARD	Labels may be on or inside the equipment, for example, a drive or motor, to alert people that dangerous voltage may be present.
 BURN HAZARD	Labels may be on or inside the equipment, for example, a drive or motor, to alert people that surfaces may reach dangerous temperatures.

Environment and Enclosure

Follow these guidelines for environment and enclosure information for this equipment.

ATTENTION

This equipment is intended for use in overvoltage Category II applications (as defined in IEC 60664-1), at altitudes up to 2000 m (6562 ft) without derating. This equipment is considered Group 1, Class A industrial equipment according to IEC/CISPR 11. Without appropriate precautions, there may be difficulties with electromagnetic compatibility in residential and other environments due to conducted and radiated disturbances.

This equipment is supplied as enclosed equipment. It should not require additional system enclosure when used in locations consistent with the enclosure type ratings stated in the Specifications section of this publication. Subsequent sections of this publication may contain additional information regarding specific enclosure type ratings, beyond what this product provides, that are required to comply with certain product safety certifications.

In addition to this publication, see:

- Industrial Automation Wiring and Grounding Guidelines, Rockwell Automation publication, [1770-4.1](#), for additional installation requirements.
- NEMA Standard 250 and IEC 60529, as applicable, for explanations of the degrees of protection provided by different types of enclosure.

Prevent Electrostatic Discharge

Follow these guidelines when you handle this equipment.

ATTENTION

This equipment is sensitive to electrostatic discharge that can cause internal damage and affect normal operation. Follow these guidelines when you handle this equipment.

- Touch a grounded object to discharge potential static.
- Wear an approved grounding wrist strap.
- Do not touch connectors or pins on component boards.
- Do not touch circuit components inside the equipment.
- Use a static-safe workstation if available.
- Store the equipment in appropriate static-safe packaging when not in use.

About the EtherNet/IP ArmorBlock 16-Point I/O Modules

The EtherNet/IP 1732E ArmorBlock is a 24V DC I/O module that communicates via EtherNet/IP. The sealed IP65, IP67 and IP69K housing of these modules requires no enclosure. Note that environmental requirements other than IP65, IP67 and IP69K may require an additional appropriate enclosure. I/O connectors are sealed M12 style.

EtherNet/IP network uses advanced network technology, for example, producer/consumer communication, to increase network functionality and throughput. Visit our web site at www.ab.com/networks for producer/consumer technology information and updates.

EtherNet/IP ArmorBlock 16-Point I/O Module

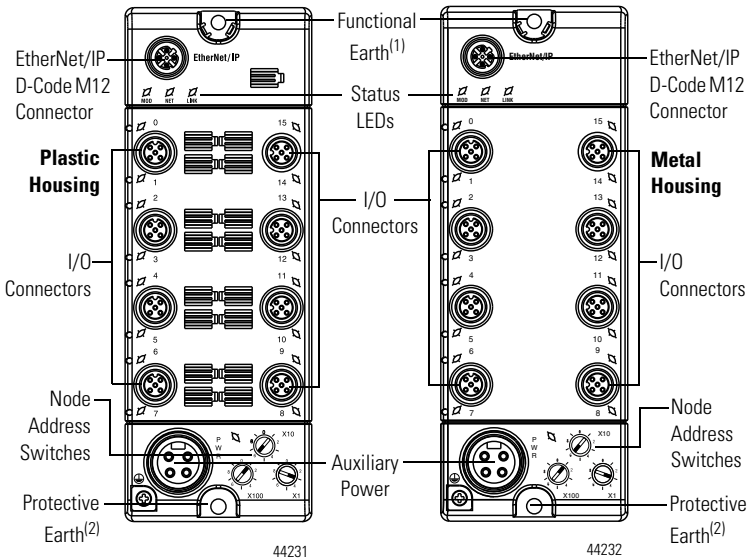

⁽¹⁾ Functional Earth grounds the I/O block's EtherNet/IP communication circuitry which is designed to mitigate the effect of noise on the network. See 10 for network connections.

⁽²⁾ Protective Earth is provided for the grounding of field devices and is internally connected to each Pin 5 of the M12 I/O connectors. See 11 for I/O connections.

AB Spa

Catalog Number Explanation

Refer to the table for a description of the catalog numbers.

Cat. No.	Description	Network Connector	Auxiliary Power
1732E-IB16M12	EtherNet 24V DC 16 Input	Single D-Code M12	Single 4-pin mini
1732E-OB16M12	EtherNet 24V DC 16, 2 A Output		
1732E-16CFGM12	EtherNet 24V DC 16 Selectable Points		
1732E-IB16M12W	EtherNet 24V DC 16 Input WeldBlock Metal Housing	Single D-Code M12	Single 4-pin mini
1732E-16CFGM12W	EtherNet 24V DC 16 Selectable Points WeldBlock Metal Housing		

Install the Module

Refer to the following sections to install your module.

- Set the Network Address
- Mount the Module
- Connect the I/O, Network and Auxiliary Cables to the ArmorBlock Module

Set the Network Address

The I/O block ships with the rotary switches set to 999 and DHCP-enabled. To change the network address, you can do one of the following:

- adjust the switches on the front of the module.
- use a Dynamic Host Configuration Protocol (DHCP) server, such as Rockwell Automation BootP/DHCP.
- retrieve the IP address from nonvolatile memory.

The I/O block reads the switches first to determine if the switches are set to a valid number. Set the network address by adjusting the 3 switches on the front

of the module. Use a small blade screwdriver to rotate the switches. Line up the small notch on the switch with the number setting you wish to use. Valid settings range from 001...254.

Network Address Example

This example shows the network address set at 163.

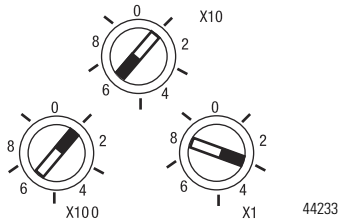

When the switches are set to a valid number, the I/O block's IP address is 192.168.1.××× (where ××× represents the number set on the switches). The I/O block's subnet mask is 255.255.255.0 and the gateway address is set to 0.0.0.0. When the I/O block uses the network address set on the switches, the I/O block does not have a host name assigned to it or use any Domain Name Server.

If the switches are set to an invalid number—for example, 000 or a value greater than 254 excluding 888—the I/O block checks to see if DHCP is enabled. If DHCP is enabled, the I/O block asks for an address from a DHCP server. The DHCP server also assigns other Transport Control Protocol (TCP) parameters.

If DHCP is not enabled, the I/O block uses the IP address, along with other TCP configurable parameters, stored in nonvolatile memory.

Mount the Module

Mount the module directly to a machine using two mounting holes, 5.3 mm (0.208 in.) in diameter. Mounting holes accommodate #6 (M3) pan head screws. The torque specification is 6.912 cm·kg (6 in·lbs).

AB Spa

Product Dimensions

Refer to the mounting dimensions illustration to help you mount the modules.

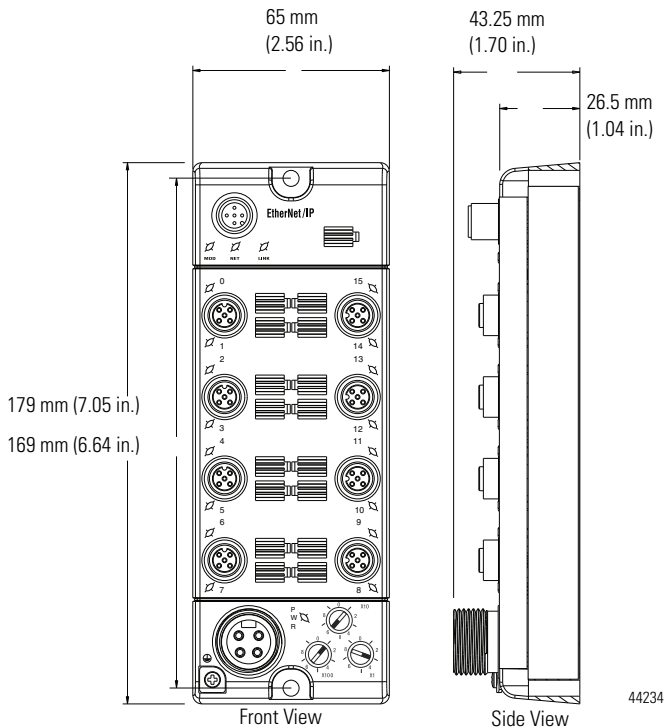

Mount the Module in High Vibration Areas

If you mount the module in an area that is subject to shock or vibration, we recommend you use a flat and a lock washer to mount the module. Mount the flat and the lock washer as shown in the mounting illustration. Torque the mounting screws to 6.912 cm·kg (6 in·lbs).

High Vibration Area Mounting

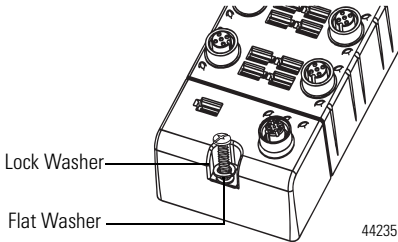

Connect the I/O, Network and Auxiliary Cables to the ArmorBlock Module

The ArmorBlock EtherNet/IP family has 5-pin micro-style connectors.

We provide caps to cover the unused connectors on your module. Connect the quick-disconnect cord sets you selected for your module to the appropriate ports.

AB Spa

Network Connectors

Refer to the pinout diagrams for the network connectors.

D-Code M12 Female Network Connector

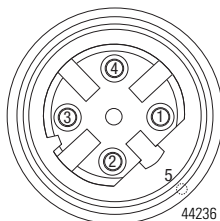

(View into Connector)

- Pin 1 M12_Tx+
- Pin 2 M12_Rx+
- Pin 3 M12_Tx-
- Pin 4 M12_Rx-
- Pin 5 Connector Shell Shield GND

IMPORTANT

Use the 1585D–M4DC–H: Polyamide small body unshielded or the 1585D–M4DC–SH: Zinc die-cast large body shielded mating connectors for the D-Code M12 female network connector.

When using shielded (STP) cable with metal housing WeldBlock products 1732E-IB16M12W and 1732E-16CFGM12W, isolate the shield at the ArmorBlock end of the cable. This minimizes the effect of ground offsets.

IMPORTANT

Use two twisted pair CAT5E UTP or STP cable.

D-Code M12 Pin	Wire Color	Signal	8-way Modular RJ45 Pin
1	White-Orange	TX+	1
2	White-Green	RX+	3
3	Orange	TX-	2
4	Green	RX-	6

I/O Connectors

Refer to the pinout diagrams for the I/O connectors.

Micro-style 5-Pin Female Input Connector

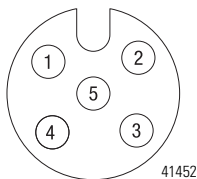

(View into Connector)

Pin 1	Sensor Source Voltage
Pin 2	Input B
Pin 3	Return
Pin 4	Input A
Pin 5	PE

Self-configuring Connector

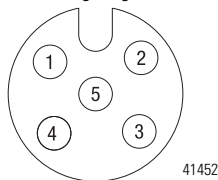

(View into Connector)

Pin 1	Sensor Source Voltage
Pin 2	Input or Output B
Pin 3	Return
Pin 4	Input or Output A
Pin 5	PE

Micro-style 5-Pin Female Output Connector

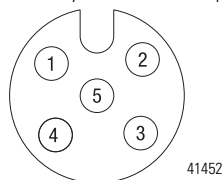

(View into Connector)

Pin 1	Not Used
Pin 2	Output B
Pin 3	Return
Pin 4	Output A
Pin 5	PE

The 1732E-16CFGM12 and the 1732E-16FGM12W self-configuring modules contain both input and output functionality.

- If an I/O point is to be an output, dedicate that point as an output with a wired load and energize it through a control program.
- Energized outputs show an associated active input that can be used as a feedback mechanism to make certain that the output is on.

- If an I/O point is to be an input, wire the input device as normal and leave the associated output de-energized at all times.

I/O Self-configure Circuitry

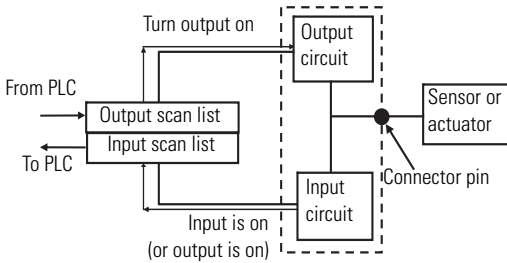

43601

Refer to the illustration for configuration operations.

Configure Operations

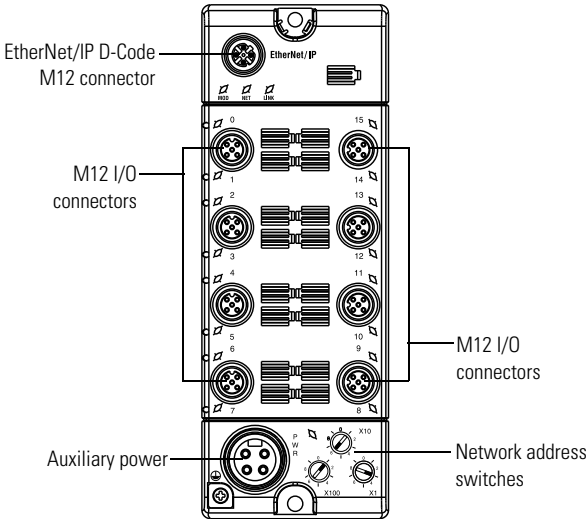

44231

The module is 24V DC Sink In/Source Out:

- 16 Input
- 16 Output
- 16 Input Or Output points or any mix of 16 (for example, 15 + 1; 8 +8)

The output is short circuit protected and output monitoring in “Self-configuring” style.

Refer to On-Machine Connectivity Catalog, publication [M117-CA001](#), for Rockwell Automation cable and cord set offerings or access the Connection Systems website at <http://www.ab.com/connectionsystems/>. You can also use the configuration tools available at <http://www.rockwellautomation.com/en/e-tools/>.

ATTENTION

Make sure all connectors and caps are securely tightened to properly seal the connections against leaks and maintain IP67 requirements.

Auxiliary Power Cable

Attach the mini-style 4-pin connector to the mini-style 4-pin receptacle as shown below.

AB Spa

Mini-style 4-Pin Female Connector (from power cable)

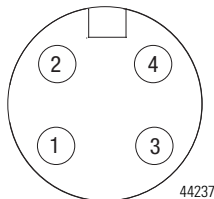

(View into Connector)

- Pin 1 Output Power+
- Pin 2 Sensor/MDL Power+
- Pin 3 Sensor/MDL Power-
- Pin 4 Output Power-

Mini-style 4-Pin Male Receptacle (on the ArmorBlock)

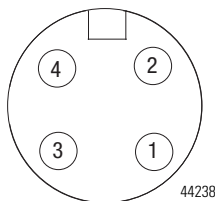

(View into Receptacle)

- Pin 1 Output Power+
- Pin 2 Sensor/MDL Power+
- Pin 3 Sensor/MDL Power-
- Pin 4 Output Power-

Auxiliary power is based on a 4-pin connector system and is used to provide 24V DC power to I/O modules and other devices. Running separate power to these devices is most typically used for I/O devices with output connections to prevent power supply interruption due to switching of outputs. However, some devices require separate auxiliary power to power them regardless of the presence of outputs.

Depending on the devices used, it may be possible to provide power through only one pair of the four available pins, and in this case the other available pair may be used for single channel E-stop through the use of special E-stop drop or power T-ports and shorting plugs. Allen-Bradley E-stop T-ports and shorting plugs are red in color for easy identification.

Interpret the LED Indicators

This module has the following indicators:

- Network, Module, and Link status indicators for EtherNet/IP
- Auxiliary Power indicator
- Individual I/O status indicators for inputs and outputs.

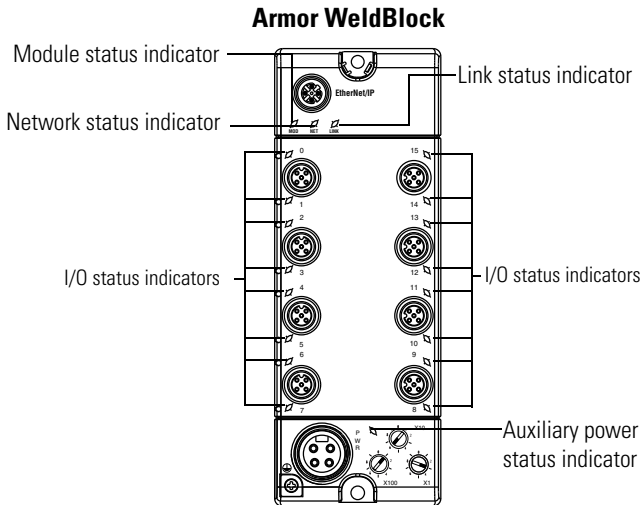

AB Spa

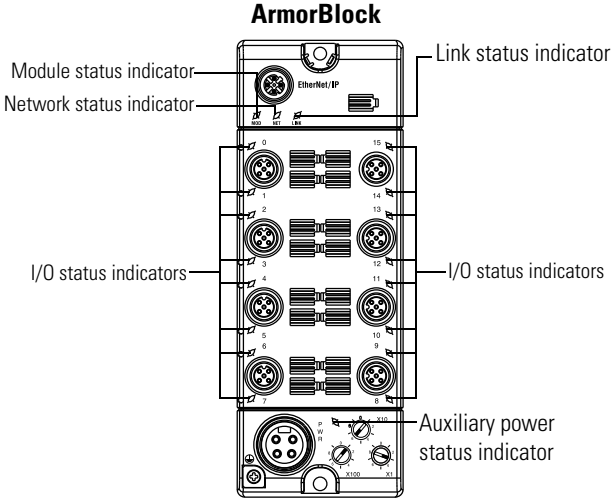

44231

Network Status Indicator – NET

State	Status	Description	Recommended Action
Off	Not online	The device is not initialized or the module does not have an IP address.	Wait until the module has completed initialization or assign an IP address.
Flashing green	No CIP connections	The device has no CIP connections. The device has an IP address, but no CIP connections are established.	Establish a network connection.
Green	CIP connections	The device is online, has an IP address, and CIP connections are established.	None

State	Status	Description	Recommended Action
Flashing red	Connection time out	One or more connections have timed out.	Reset connections to the module.
Red	Duplicate IP	The module has detected that its IP address is already in use.	Resolve the IP address conflict.
Flashing red/green	Self-test in progress	The module is performing a powerup self-test.	None

Module Status Indicator – MOD

State	Status	Description	Recommended Action
Off	Not powered	There is no power applied to the device.	Apply power to the device.
Flashing red/green	LED powerup test	The module is performing a powerup self-test.	None
Green	Module operational	The module is operating normally.	None
Flashing red	Minor fault	The module has one of the following recoverable faults: <ul style="list-style-type: none"> •Firmware (NVS) update. •IP Address switches have changed. 	<ul style="list-style-type: none"> •Check your configuration and cycle power. •If a firmware update is in progress, wait for it to complete. •Verify that IP address switches are set to the desired value.
Solid red	Critical fault	The module has one of the following unrecoverable faults: <ul style="list-style-type: none"> •Self-test failure (checksum failure or ramtest failure at powerup). •Firmware fatal error. 	Cycle power to the module. If that does not fix the fault, contact your Rockwell Automation representative. The module may need to be replaced.

IMPORTANT

The Module Status LED indicator remains solid red for a maximum of 30 s while the module completes its POST (Power-On Self Test).

Network Link Status Indicator – LINK

State	Status	Description	Recommended Action
Off	No network link	There is no network link established.	Establish a network link.
Flashing green/off	Network link active	There is transmitting or receiving activity to the module.	None
Steady green	Network link present	There is a network link to the module.	None

Auxiliary Status Indicator – PWR

State	Status	Description	Recommended Action
Off	No auxiliary power	There is no auxiliary power applied to the module.	Apply auxiliary power to the module.
Green	Auxiliary power present	There is auxiliary power applied to the module.	None

I/O Status Indicator – Individual Channels as Indicated by Numbers 0...15

State	Status	Description	Recommended Action
Off	Output not energized or no valid input	Output is not energized or input is not valid.	None
Yellow	Output energized or valid input	Output is energized or input is valid.	None

Specifications

ArmorBlock 2-Port EtherNet/IP Module – 1732E-IB16M12x, 1732E-16CFGM12x

Attributes	Value
Number of inputs	16
Input type	Sink, 24V DC
Voltage, off-state input, max	5V DC
Voltage, on-state input, max	30V DC
Voltage, on-state input, nom	24V DC
Voltage, on-state input, min	11V DC
Voltage, sensor source, max	30V
Voltage, sensor source, min	11V
Current, off-state input, max	1.5 mA @ 5V DC
Current, on-state input, max	5 mA @ 30V DC
Input delay time - ON to OFF and OFF to ON	0...16000 μ s

ArmorBlock 2-Port EtherNet/IP Module – 1732E-16CFGM12x, 1732E-OB16M12

Attribute	Value
Number of outputs	16
Output type	Source, 24V DC
Voltage drop, on-state output, max	0.5V DC
Voltage off-peak blocking, min	30V DC
Voltage, on-state output, max	30V DC
Voltage, on-state output, min	11V DC
Voltage, on-state output, nom	24V DC
Voltage, sensor source, max	30V

ArmorBlock 2-Port EtherNet/IP Module – 1732E-16CFGM12x, 1732E-OB16M12

Current on-state output, max	0.5 A – 1732E-16CFGM12x 2 A – 1732E-OB16M12
Current per module, max	8.0 A (all outputs)
Leakage current, off-state output, max	50 μ A
Surge current per output, max	3.2 A for 10 ms, repeatable every 2 s – 1732E-16CFGM12x 6 A for 10 ms, repeatable every 2 s – 1732E-OB16M12x
Pilot duty rating	DC-14 Pilot Duty

General Specifications

Attribute	Value
Voltage, auxiliary power, max	30V DC
Voltage, auxiliary power, min	12V DC
Current, auxiliary power input, max per module (pins 2, 3)	1.1 A 0.3 A – 1732E-OB16M12
Current, auxiliary power, max per module (pins 1, 4 plus pins 2, 3)	8 A (pins 2, 3 for sensor source and module plus pins 1, 4 for output loads)
Current, sensor source, per input, max	50 mA
Current, sensor source, per module, max (pins 2, 3)	800 mA
Communication rate	EtherNet/IP 10/100 Mbps Full or half-duplex 100 meter per segment
LED indicators	Module status – red/green Network status – red/green Link status – green Auxiliary power – green I/O LED – yellow

General Specifications

Attribute	Value
Dimensions (HxWxD), approx.	179 x 65 x 43.25 mm (7.05 x 2.56 x 1.70 in.)
Weight, approx.	0.34 kg (0.75 lb)
Enclosure type rating	Meets IP65/66/67/69K (when marked), and NEMA 4X/6P with receptacle dust caps or cable termination.
Isolation voltage	50V (continuous), Reinforced Insulation Type Type tested @ 707V DC for 60 s, I/O to Ethernet, Power to Ethernet
Wiring category ⁽¹⁾	1 – on signal ports 1 – on power ports 2 – on communications ports

⁽¹⁾ Use this Conductor Category information for planning conductor routing. Refer to publication [1770-4.1](#), Industrial Automation Wiring and Grounding Guidelines.

Environmental Specifications

Attribute	Value
Temperature, operating	IEC 60068-2-1 (Test Ad, Operating Cold), IEC 60068-2-2 (Test Bd, Operating Dry Heat), IEC 60068-2-14 (Test Nb, Operating Thermal Shock): -20...60 °C (-4...140 °F)
Temperature, storage	IEC 60068-2-1 (Test Ab, Un-packaged Non-operating Cold), IEC 60068-2-2 (Test Bb, Un-packaged Non-operating Dry Heat), IEC 60068-2-14 (Test Na, Un-packaged Non-operating Thermal Shock): -40...85 °C (-40...185 °F)
Temperature, ambient, max	60 °C (140 °F)
Relative humidity	IEC 60068-2-30 (Test Db, Un-packaged Damp Heat): 5...95% non-condensing

Environmental Specifications

Attribute	Value
Vibration	IEC60068-2-6 (Test Fc, Operating): 5 g @ 10...500 Hz
Shock, operating	IEC60068-2-27 (Test Ea, Unpackaged Shock): 30 g
Shock, non-operating	IEC60068-2-27 (Test Ea, Unpackaged Shock): 50 g
Emissions	CISPR 11: Group 1, Class A
ESD immunity	IEC 61000-4-2: 8 kV contact discharges 8 kV air discharges
Radiated RF immunity	IEC 61000-4-3: 10V/m with 1 kHz sine-wave 80% AM from 80...2000 MHz 10V/m with 200 Hz 50% Pulse 100% AM at 900 Mhz 10V/m with 200 Hz 50% Pulse 100% AM at 1890 Mhz 1V/m with 1 kHz sine-wave 80% AM from 2000...2700 MHz
EFT/B immunity	IEC 61000-4-4: ±4 kV at 5 kHz on power ports ±3 kV at 5 kHz on signal ports ±2 kV at 5 kHz on communications ports
Surge transient immunity	IEC 61000-4-5: ±1 kV line-line(DM) and ±2 kV line-earth(CM) on power ports ±1 kV line-line(DM) and ±2 kV line-earth(CM) on signal ports ±2 kV line-earth(CM) on communications ports
Conducted RF immunity	IEC 61000-4-6: 10V rms with 1 kHz sine-wave 80% AM from 150 kHz...80 MHz

Certifications

Certification (when product is marked)⁽¹⁾	Value
c-UL-us	UL Listed Industrial Control Equipment, certified for US and Canada. See UL File E322657.
CE	European Union 89/336/EEC EMC Directive, compliant with: EN 61326; Meas./Control/Lab., Industrial Requirements EN 61000-6-2; Industrial Immunity EN 61000-6-4; Industrial Emissions EN 61131-2; Programmable Controllers (Clause 8, Zone A & B)
C-Tick	Australian Radiocommunications Act, compliant with: AS/NZS CISPR 11; Industrial Emissions
EtherNet/IP	ODVA conformance tested to EtherNet/IP specifications

⁽¹⁾ See the Product Certification link at <http://www.ab.com> for Declaration of Conformity, Certificates, and other certification details.

Rockwell Automation Support

Rockwell Automation provides technical information on the Web to assist you in using its products. At <http://www.rockwellautomation.com/support/>, you can find technical manuals, a knowledge base of FAQs, technical and application notes, sample code and links to software service packs, and a MySupport feature that you can customize to make the best use of these tools.

For an additional level of technical phone support for installation, configuration, and troubleshooting, we offer TechConnect support programs. For more information, contact your local distributor or Rockwell Automation representative, or visit <http://www.rockwellautomation.com/support/>.

Installation Assistance

If you experience a problem within the first 24 hours of installation, please review the information that's contained in this manual. You can also contact a special Customer Support number for initial help in getting your product up and running.

United States or Canada	1.440.646.3434
Outside United States or Canada	Use the Worldwide Locator at http://www.rockwellautomation.com/support/americas/phone_en.html , or contact your local Rockwell Automation representative.

New Product Satisfaction Return

Rockwell Automation tests all of its products to ensure that they are fully operational when shipped from the manufacturing facility. However, if your product is not functioning and needs to be returned, follow these procedures.

United States	Contact your distributor. You must provide a Customer Support case number (call the phone number above to obtain one) to your distributor to complete the return process.
Outside United States	Please contact your local Rockwell Automation representative for the return procedure.

Documentation Feedback

Your comments will help us serve your documentation needs better. If you have any suggestions on how to improve this document, complete this form, publication [BA-DU002](#), available at <http://www.rockwellautomation.com/literature/>.

Allen-Bradley, Rockwell Automation, ArmorBlock, and TechConnect are trademarks of Rockwell Automation, Inc.

Trademarks not belonging to Rockwell Automation are property of their respective companies.

Rockwell Otomasyon Ticaret A.Ş., Kar Plaza İş Merkezi E Blok Kat:6 34752 İçerenköy, İstanbul, Tel: +90 (216) 5698400

www.rockwellautomation.com

Power, Control and Information Solutions Headquarters

Americas: Rockwell Automation, 1201 South Second Street, Milwaukee, WI 53204-2496 USA, Tel: (1) 414.382.2000, Fax: (1) 414.382.4444
Europe/Middle East/Africa: Rockwell Automation NV, Pegasus Park, De Kleetlaan 12a, 1831 Diegem, Belgium, Tel: (32) 2 663 0600, Fax: (32) 2 663 0640
Asia Pacific: Rockwell Automation, Level 14, Core F, Cyberport 3, 100 Cyberport Road, Hong Kong, Tel: (852) 2887 4788, Fax: (852) 2508 1846

Publication 1732E-IN002B-EN-E - February 2011

Supersedes Publication 1732E-IN002A-EN-E - April 2007

Copyright © 2011 Rockwell Automation, Inc. All rights reserved.