



ArmorBlock 2-Port EtherNet/IP Module

Catalog Numbers 1732E-IB16M12R, 1732E-OB16M12R,
1732E-IB16M12DR, 1732E-OB16M12DR, 1732E-16CFGM12R,
1732E-IB16M12SOEDR, 1732E-8X8M12DR

Table of Contents

Topic	Page
Important User Information	2
Environment and Enclosure	3
Preventing Electrostatic Discharge	3
Overview	4
Catalog Number Explanation	6
Install the Module	6
Set the Network Address	6
Mount the Module	7
Product Dimensions	8
Connect the I/O, Network and Auxiliary Cables to the Module	9
Configure the Module	12
Interpret LED Indicators	13
Specifications	15

Important User Information

Solid-state equipment has operational characteristics differing from those of electromechanical equipment. Safety Guidelines for the Application, Installation and Maintenance of Solid State Controls (Publication [SGI-1.1](#) available from your local Rockwell Automation sales office or online at <http://www.rockwellautomation.com/literature/>) describes some important differences between solid-state equipment and hard-wired electromechanical devices. Because of this difference, and also because of the wide variety of uses for solid-state equipment, all persons responsible for applying this equipment must satisfy themselves that each intended application of this equipment is acceptable.





In no event will Rockwell Automation, Inc. be responsible or liable for indirect or consequential damages resulting from the use or application of this equipment.

The examples and diagrams in this manual are included solely for illustrative purposes. Because of the many variables and requirements associated with any particular installation, Rockwell Automation, Inc. cannot assume responsibility or liability for actual use based on the examples and diagrams.

No patent liability is assumed by Rockwell Automation, Inc. with respect to use of information, circuits, equipment, or software described in this manual.

Reproduction of the contents of this manual, in whole or in part, without written permission of Rockwell Automation, Inc., is prohibited.

Throughout this manual, when necessary, we use notes to make you aware of safety considerations.

	WARNING: Identifies information about practices or circumstances that can cause an explosion in a hazardous environment, which may lead to personal injury or death, property damage, or economic loss.
	ATTENTION: Identifies information about practices or circumstances that can lead to personal injury or death, property damage, or economic loss. Attentions help you identify a hazard, avoid a hazard and recognize the consequences.
	SHOCK HAZARD: Labels may be on or inside the equipment (for example, drive or motor) to alert people that dangerous voltage may be present.
	BURN HAZARD: Labels may be on or inside the equipment (for example, drive or motor) to alert people that surfaces may reach dangerous temperatures.
IMPORTANT	Identifies information that is critical for successful application and understanding of the product.

Environment and Enclosure



ATTENTION: This equipment is intended for use in overvoltage Category II applications (as defined in IEC 60664-1), at altitudes up to 2000 m (6562 ft) without derating.

This equipment is considered Group 1, Class A industrial equipment according to IEC/CISPR 11. Without appropriate precautions, there may be difficulties with electromagnetic compatibility in residential and other environments due to conducted and radiated disturbances.

This equipment is supplied as enclosed equipment. It should not require additional system enclosure when used in locations consistent with the equipment Enclosure Type Ratings. Subsequent sections of this publication may contain more information regarding specific enclosure type ratings, beyond what this product provides, that are required to comply with certain product safety certifications.

In addition to this publication, see:

- Industrial Automation Wiring and Grounding Guidelines, Rockwell Automation publication [1770-4.1](#), for additional installation requirements.
- NEMA Standard 250 and IEC 60529, as applicable, for explanations of the degrees of protection provided by different types of enclosure.

Preventing Electrostatic Discharge



ATTENTION: This equipment is sensitive to electrostatic discharge, which can cause internal damage and affect normal operation. Follow these guidelines when you handle this equipment:

- Touch a grounded object to discharge potential static.
 - Wear an approved grounding wriststrap.
 - Do not touch connectors or pins on component boards.
 - Do not touch circuit components inside the equipment.
 - Use a static-safe workstation, if available.
 - Store the equipment in appropriate static-safe packaging when not in use.
-

Additional Resources

Resource	Description
Pinout Guide for 1732 ArmorBlock 2 Port Ethernet Block, publication 1732E-WD001	Detailed description of how to wire your module.
1732E EtherNet/IP ArmorBlock supporting Sequence of Events, publication 1732E-UM002	Detailed description of how to install, configure and use your 1732E-IB16M12SOEDR module.
Integrated Architecture and CIP Sync Configuration, publication IA-AT003	Detailed explanation on how to set up and use ArmorBlock modules in a CIP Sync application.
Industrial Automation Wiring and Grounding Guidelines, publication 1770-4.1	More information on proper wiring and grounding techniques.

If you would like a manual, you can:

- download a free electronic version from the internet:
<http://www.rockwellautomation.com/literature/>
- purchase a printed manual by contacting your local Allen-Bradley distributor or Rockwell Automation representative

Overview

The EtherNet/IP ArmorBlock is a 24V DC I/O module that communicates via EtherNet/IP. The sealed IP65, IP67 and IP69K housing of these modules requires no enclosure. I/O connectors are sealed M12 style.

EtherNet/IP networks use advanced network technology, for example, producer/consumer communication, to increase network functionality and throughput.

Module Identification

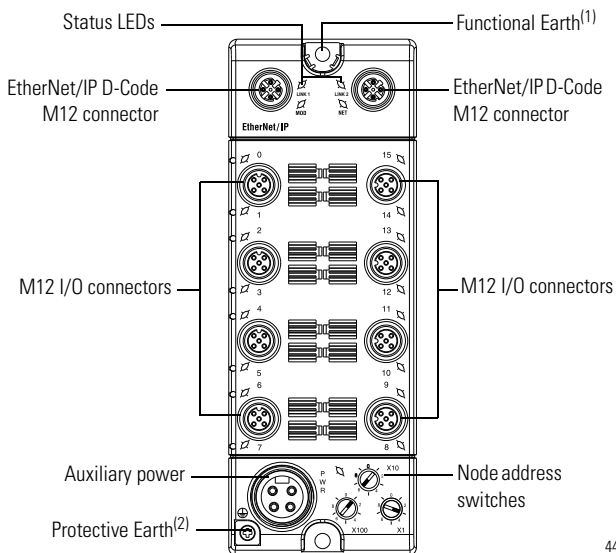

44945

(1) Protective Earth is provided for the grounding of field devices and is internally connected to each Pin 5 of the M12 I/O connectors. See I/O Connectors on page 9.

(2) Functional Earth grounds the I/O block's EtherNet/IP communication circuitry which is designed to mitigate the effect of noise on the network. See EtherNet/IP Connector on page 10.

Catalog Number Explanation

Refer to the table for a description of the module catalog numbers.

Catalog Number	Description	Network Connector	Auxiliary Power
1732E-IB16M12R	16 Channel 24V DC Digital Input Dual-Port EtherNet Module	Dual D-code M12	Single 4-pin mini
1732E-OB16M12R	16 Channel 24V DC Digital Output Dual-Port EtherNet Module		
1732E-16CFGM12R	16 Channel 24V DC Configurable Digital I/O Dual-Port EtherNet Module		
1732E-IB16M12DR	Diagnostic 16 Channel 24V DC Digital Input Dual-Port EtherNet Module		
732E-OB16M12DR	Diagnostic 16 Channel 24V DC Digital Output Dual-Port EtherNet Module		
1732E-8X8M12DR	Diagnostic 8-Input/8-Output 24V DC Digital I/O Dual-Port EtherNet Module		
1732E-IB16M12SOEDR	Diagnostic Sequence of Events 16 Channel 24V DC Digital Input Dual-Port EtherNet Module		

Install the Module

To install the module:

- Set the network address
- Mount the module
- Connect the I/O, Network and Auxiliary cables to the module.

Set the Network Address

The I/O block ships with the rotary switches set to 999 and DHCP enabled.

To change the network address, you can do one of the following:

- adjust the switch on the front of the module.
- use a Dynamic Host Configuration Protocol (DHCP) server, such as Rockwell Automation BootP/DHCP.
- retrieve the IP address from nonvolatile memory.

The I/O block reads the switches first to determine if the switches are set to a valid number. To set the network address:

1. Rotate the three (3) switches on the front of the module using a small blade screwdriver.

2. Line up the small notch on the switch with the number setting you wish to use. Valid settings range from 001...254.
3. Cycle power.

Set Network Address

Example shows default node address set at 163.

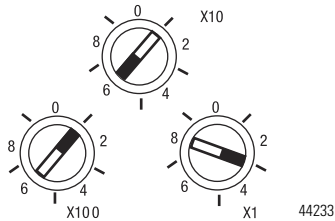

When the switches are set to a valid number, the I/O block's IP address is 192.168.1.xxx (where xxx represents the number set on the switches). The I/O block's subnet mask is 255.255.255.0 and the gateway address is set to 0.0.0.0. When the I/O block uses the network address set on the switches, the I/O block does not have a host name assigned to it or use any Domain Name Server.

If the switches are set to an invalid number (for example, 000 or a value greater than 254 excluding 888), the I/O block checks to see if DHCP is enabled. If DHCP is enabled, the I/O block asks for an address from a DHCP server. The DHCP server also assigns other Transport Control Protocol (TCP) parameters.

If DHCP is not enabled, the I/O block uses the IP address (along with other TCP configurable parameters) stored in nonvolatile memory.

Mount the Module

Two sets of mounting holes are used to mount the module directly to a panel or machine. Mounting holes accommodate #8 (M4) pan head screws. The torque specification is 1.13 Nm (10 in-lb).

Product Dimensions

Refer to the mounting dimensions illustration to help you mount the module.

Module Dimensions

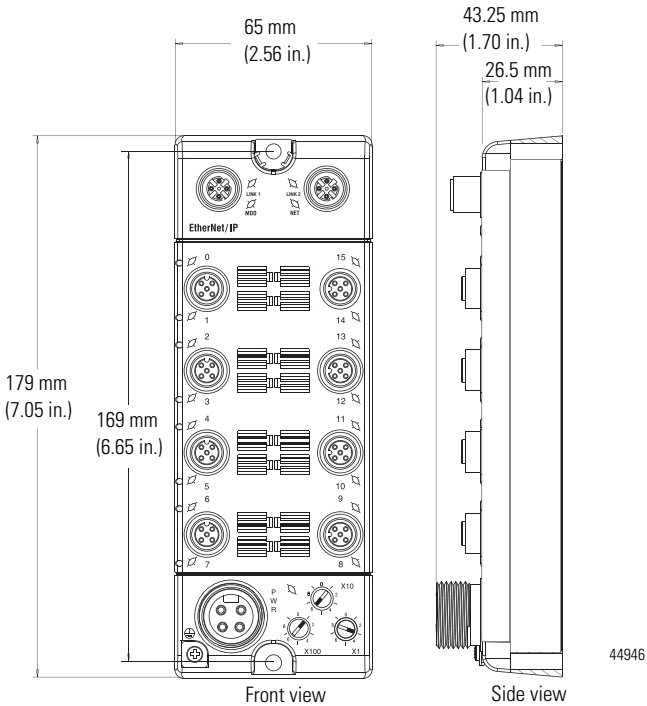

Mount the Module in High Vibration Areas

If you mount the module in an area that is subject to shock or vibration, we recommend you use a flat and a lock washer to mount the module. Mount the flat and the lock washer as shown in the mounting illustration. Torque the mounting screws to 1.13 Nm (10 in-lb).

High Vibration Area Mounting

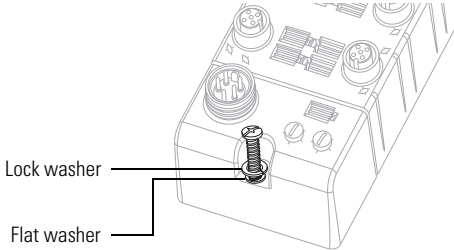

44766

Connect the I/O, Network and Auxiliary Cables to the Module

The ArmorBlock EtherNet/IP family has 5-pin micro-style connectors. We provide caps to cover the unused connectors on your module. Connect the quick-disconnect cord sets you selected for your module to the appropriate ports.

I/O Connectors

Refer to the pinout diagrams for the I/O connectors

Micro-style 5-Pin Input Female Connector

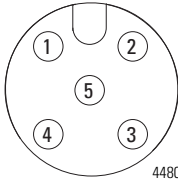

44807

(View into connector)

Pin 1 Sensor source voltage

Pin 2 Input B

Pin 3 Return

Pin 4 Input A

Pin 5 PE

Micro-style 5-Pin Output Female Connector

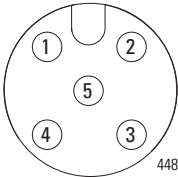

44807

(View into connector)

Pin 1 Not used

Pin 2 Output B

Pin 3 Return

Pin 4 Output A

Pin 5 PE

Self-configuring Connector

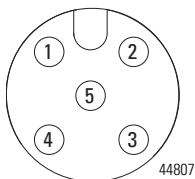

(View into connector)

Pin 1 Sensor source voltage

Pin 2 Input or output B

Pin 3 Return

Pin 4 Input or output A

Pin 5 PE

I/O Self-configure Circuitry

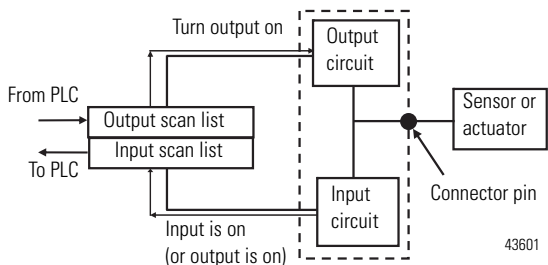

EtherNet/IP Connector

D-Code Micro Network Female Connector

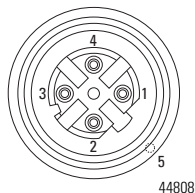

(View into connector)

Pin 1 M12_Tx+

Pin 2 M12_Rx+

Pin 3 M12_Tx-

Pin 4 M12_Rx-

Pin 5 Connector shell shield FE



ATTENTION: Make sure all connectors and caps are securely tightened to properly seal the connections against leaks and maintain IP enclosure requirements.

IMPORTANT Use the 1585D–M4DC–H: Polyamide small body unshielded or the 1585D–M4DC–SH: Zinc die-cast large body shielded mating connectors for the D-Code M12 female network connector.

IMPORTANT Use two twisted pair CAT5E UTP or STP cables.

D-Code M12 Pin	Wire color	Signal	8-way modular RJ45 pin
1	White-Orange	TX+	1
2	White-Green	RX+	3
3	Orange	TX-	2
4	Green	RX-	6

The 1732E-16CFGM12R self-configuring module contains both input and output functionality.

- If an I/O point is to be an output, dedicate that point as an output with a wired load and energize it through a control program.
- Energized outputs show an associated active input that can be used as a feedback mechanism to make certain that the output is on.
- If an I/O point is to be an input, wire the input device as normal and leave the associated output de-energized at all times.

Auxiliary Power Connector

Attach the mini-style 4-pin connector to the mini-style 4-pin receptacle as shown below.

Mini-style 4-Pin Input Male Receptacle

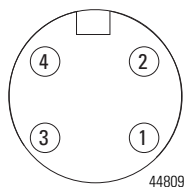

(View into receptacle)

- Pin 1 Output power+
- Pin 2 Sensor/MDL power+
- Pin 3 Sensor/MDL power-
- Pin 4 Output power-

Auxiliary Power is based on a 4-pin connector system and is used to provide 24V DC power to I/O modules and other devices. Running separate power to these devices is most typically used for I/O devices with output connections to prevent power supply interruption due to switching of outputs. However, some devices require separate auxiliary power to power them regardless of the presence of outputs.

12 ArmorBlock 2-Port EtherNet/IP Module

Depending on the devices used, it may be possible to provide power through only one pair of the four available pins, and in this case the other available pair may be used for single channel E-stop through the use of special E-stop drop or power T-ports and shorting plugs. Allen-Bradley E-stop T-ports and shorting plugs are red in color for easy identification.



ATTENTION: To comply with the CE Low Voltage Directive (LVD), this equipment and all connected I/O must be powered from a source compliant with the following:
Safety Extra Low Voltage (SELV) or Protected Extra Low Voltage (PELV).



ATTENTION: To comply with UL restrictions, this equipment must be powered from a source compliant with the following: Limited Voltage/Current.

Configure the Module

Refer to the illustration for configuration operations.

Configure Operations

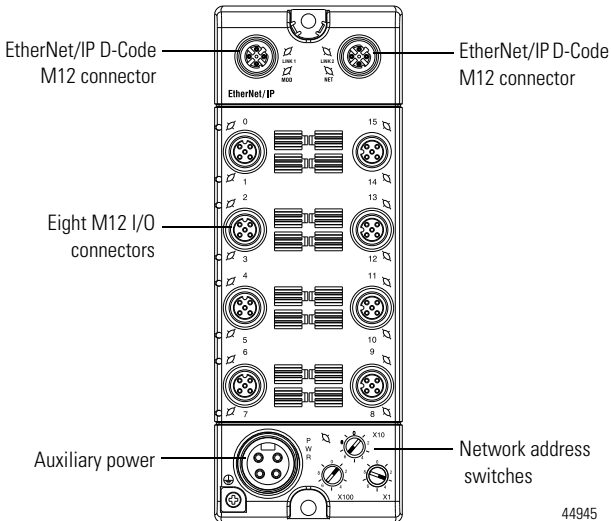

44945

Refer to On-Machine Connectivity Catalog, publication [M117-CA001](#), for Rockwell Automation cable and cord set offerings or use the configuration tools available at www.rockwellautomation.com/en/e-tools/.

Interpret LED Indicators

This module has the following indicators:

- Network, Module, and Link status indicators for EtherNet/IP
- Auxiliary Power indicator
- Individual I/O status indicators for inputs and outputs

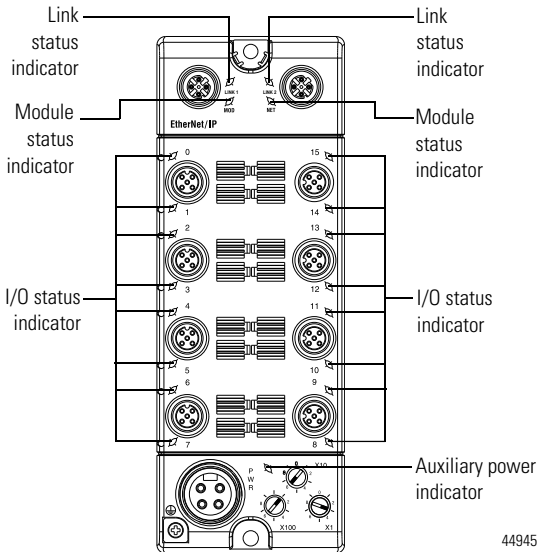

44945

Indicator Status for Modules

Indicator	Status	Description
Module status	Off	No power applied to device.
	Flashing red/green	The module is performing POST (Power-On Self Test), which completes within 30 s.
	Green	Device operating normally.
	Flashing red	Recoverable fault.
	Red	Unrecoverable fault – may require device replacement.
Network status	Off	The device is not initialized or the module does not have an IP address.
	Flashing green	The device has no CIP connections. The device has an IP address, but no CIP connections are established.
	Green	The device is online, has an IP address, and CIP connections are established.
	Flashing red	One or more connections have timed out.
	Red	The module has detected that its IP address is already in use.
	Flashing red/green	The module is performing a powerup self-test.
Network link status	Off	No link established.
	Green	Link established on indicated port at 100 Mbps.
	Flashing green	Link activity present on indicated port at 100 Mbps.
	Yellow	Link established on indicated port at 10 Mbps.
	Flashing yellow	Link activity present on indicated port at 10 Mbps.
Auxiliary status	Off	No auxiliary power to device or input not valid.
	Green	Auxiliary power applied to device.
Digital output status ⁽¹⁾	Off	Output not energized.
	Yellow	Output energized.
	Red	Output shorted.
	Flashing red	Output open load.
Digital input status ⁽¹⁾	Off	No valid input.
	Yellow	Valid input.
	Red	Sensor source voltage shorted.
	Flashing red	Sensor source open wire.

⁽¹⁾ Only diagnostic modules 1732E-*DR have red I/O status indicators.

Specifications

1732E ArmorBlock 2-Port EtherNet Module Input – 1732E-8X8M12DR, 1732E-IB16M12R, 1732E-IB16M12DR, 1732E-IB16M12SOEDR, 1732E-16CFGM12R

Attribute	Value
Number of inputs	8 – 1732E-8X8M12DR 16 – all other modules
Input type	Sink, 24V DC
Voltage, off-state input, max	5V DC
Voltage, on-state input, max	30V DC
Voltage, on-state input, nom	24V DC
Voltage, on-state input, min	11V DC
Current, off-state input, max	1.5 mA @ 5V DC
Current, on-state input, max	5 mA @ 30V DC
Voltage, sensor source, max	30V DC
Voltage, sensor source, min	10V DC
Input delay time ON to OFF OFF to ON	0...16000 μ s
Isolation voltage	50V (continuous), Basic Insulation Type, Inputs and Sensor Power to Network. No isolation between individual Inputs or between Network channels. Type tested at 707V DC for 60 s.

1732E ArmorBlock 2-Port EtherNet Module Output – 1732E-8X8M12DR, 1732E-OB16M12R, 1732E-OB16M12DR, 1732E-16CFGM12R

Attribute	Value
Number of outputs	8 – 1732E-8X8M12DR 16 – all other modules
Output type	Source, 24V DC
Voltage drop, on-state output, max	0.5V DC
Voltage off-peak blocking, min	30V DC
Voltage, on-state output, max	30V DC
Voltage, on-state output, min	11V DC

1732E ArmorBlock 2-Port EtherNet Module Output – 1732E-8X8M12DR, 1732E-OB16M12R, 1732E-OB16M12DR, 1732E-16CFGM12R

Attribute	Value
Voltage, on-state output, nom	24V DC
Current on-state output, max	2.0 A – 1732E-OB16M12R 0.5 A – all other modules
Current per module, max	4.0 A – 1732E-8X8M12DR 8.0 A – all other modules
Leakage current, off-state output, max	50 μ A – 1732E-OB16M12R, 1732E-16CFGM12R 500 μ A – all other modules
Surge current per output, min	4.8 A for 10 ms, repeatable every 2 s – 1732E-OB16M12R 1.2 A for 10 ms, repeatable every 2 s – all other modules
Pilot duty rating	DC-14
Isolation voltage	50V (continuous), Basic Insulation Type, Outputs and Output Power to Network. No isolation between individual Outputs or between Outputs and Output power or between Network channels. Type tested at 707V DC for 60 s.

General Specifications

Attribute	Value
Voltage, auxiliary power, max	30V DC
Voltage, auxiliary power, min	12V DC
Current, Ethernet system power, max (pins 2, 3 sensor source/module power)	0.4 A – 1732E-OB16M12R, 1732E-OB16M12DR 0.8 A – 1732E-8X8M12DR 1.2 A – 1732E-IB16M12R, 1732E-IB16M12DR, 1732E-IB16M12SOEDR, 1732E-16CFGM12R
Current, auxiliary power, max per output module (pins 2, 3 sensor source/module power plus pins 1, 4 for output loads)	4 A – 1732E-8X8M12DR 8 A – all other modules
Current, sensor source, per input, max	50 mA
Current, sensor source, per connector, max	100 mA
Communication rate	EtherNet/IP 10/100 Mbps Full or half-duplex 100 meter per segment

General Specifications

Attribute	Value
Isolation voltage	50V (continuous), Basic Insulation Type, Inputs and Sensor Power to Network No isolation between individual Inputs or between Network channels Type tested at 707V DC for 60 s
Status indicators	Module status - red/green Network status - red/green Link status - green/yellow Auxiliary power - green I/O LED - yellow I/O LED - yellow/red – 1732E-*DR modules only
Dimensions (HxWxD), approx.	179 x 65 x 43.25 mm (7.05 x 2.56 x 1.70 in.)
Weight, approx.	0.34 kg (0.75 lb)
Enclosure type rating	Meets IP65/66/67/69K (when marked), and Type 4X with receptacle dust caps or cable termination.
Wiring category ⁽¹⁾	1 – on signal ports 1 – on power ports 1 – on communications port

⁽¹⁾ Use this Conductor Category information for planning conductor routing. Refer to Industrial Automation Wiring and Grounding Guidelines, publication [1770-4.1](#).

Environmental Specifications

Attribute	Value
Temperature, operating	IEC 60068-2-1 (Test Ad, Operating Cold), IEC 60068-2-2 (Test Bd, Operating Dry Heat), IEC 60068-2-14 (Test Nb, Operating Thermal Shock): -20...60 °C (-4...140 °F)
Temperature, surrounding, max.	60 °C (140 °F)
Temperature, storage	IEC 60068-2-1 (Test Ab, Unpackaged Non-operating Cold), IEC 60068-2-2 (Test Bb, Unpackaged Non-operating Dry Heat), IEC 60068-2-14 (Test Na, Unpackaged Non-operating Thermal Shock): -40...85 °C (-40...185 °F)
Relative humidity	IEC 60068-2-30 (Test Db, Unpackaged Damp Heat): 5...95% noncondensing
Vibration	IEC 60068-2-6 (Test Fc, Operating): 5 g @ 10... 500 Hz
Shock, operating	IEC 60068-2-27 (Test Ea, Unpackaged Shock): 30 g

Environmental Specifications

Attribute	Value
Shock, non-operating	IEC 60068-2-27 (Test Ea, Unpackaged Shock): 50 g
Emissions	CISPR 11 Group 1, Class A
ESD immunity	IEC 61000-4-2: 6 kV contact discharges 8 kV air discharges
Radiated RF immunity	IEC 61000-4-3: 10V/m with 1 kHz sine-wave 80% AM from 80...2000 MHz 10V/m with 200 Hz 50% Pulse 100% AM @ 900 Mhz 10V/m with 200 Hz 50% Pulse 100% AM @ 1890 Mhz 3V/m with 1 kHz sine-wave 80% AM from 2000...2700 MHz
EFT/B immunity	IEC 61000-4-4: ±4 kV @ 5 kHz on power ports ±3 kV @ 5 kHz on signal ports ±3 kV @ 5 kHz on communications ports
Surge transient immunity	IEC 61000-4-5: ±1 kV line-line(DM) and ±2 kV line-earth(CM) on power ports ±1 kV line-line(DM) and ±2 kV line-earth(CM) on signal ports ±2 kV line-earth(CM) on communications ports
Conducted RF immunity	IEC 61000-4-6: 10V rms with 1 kHz sine-wave 80% AM from 150 kHz...80 MHz

Certifications

Certification (when product is marked) ⁽¹⁾	Value
c-UL-us	UL Listed Industrial Control Equipment, certified for US and Canada. See UL File E322657.
CE	European Union 2014/30/EU EMC Directive, compliant with: EN 61326-1; Meas./Control/Lab., Industrial Requirements EN 61000-6-2; Industrial Immunity EN 61000-6-4; Industrial Emissions EN 61131-2; Programmable Controllers (Clause 8, Zone A & B)
RCM	Australian Radiocommunications Act, compliant with: AS/NZS CISPR 11; Industrial Emissions
EtherNet/IP	ODVA conformance tested to EtherNet/IP specifications.
KC	Korean Registration of Broadcasting and Communications Equipment, compliant with: Article 58-2 of Radio Waves Act, Clause 3

⁽¹⁾ See the Product Certification link at <http://www.rockwellautomation.com/products/certification/> for Declaration of Conformity, Certificates, and other certification details.

Rockwell Automation Support

Rockwell Automation provides technical information on the Web to assist you in using its products. At <http://www.rockwellautomation.com/support/>, you can find technical manuals, a knowledge base of FAQs, technical and application notes, sample code and links to software service packs, and a MySupport feature that you can customize to make the best use of these tools.

For an additional level of technical phone support for installation, configuration and troubleshooting, we offer TechConnect support programs. For more information, contact your local distributor or Rockwell Automation representative, or visit <http://www.rockwellautomation.com/support/>.

Installation Assistance

If you experience a problem within the first 24 hours of installation, please review the information that's contained in this manual. You can also contact a special Customer Support number for initial help in getting your product up and running.

United States or Canada	1.440.646.3434
Outside United States or Canada	Use the Worldwide Locator at http://www.rockwellautomation.com/support/americas/phone_en.html , or contact your local Rockwell Automation representative.

New Product Satisfaction Return

Rockwell Automation tests all of its products to ensure that they are fully operational when shipped from the manufacturing facility. However, if your product is not functioning and needs to be returned, follow these procedures.

United States	Contact your distributor. You must provide a Customer Support case number (call the phone number above to obtain one) to your distributor to complete the return process.
Outside United States	Please contact your local Rockwell Automation representative for the return procedure.

Documentation Feedback

Your comments will help us serve your documentation needs better. If you have any suggestions on how to improve this document, complete this form, publication [RA-DU002](#), available at <http://www.rockwellautomation.com/literature/>.

Allen-Bradley, Rockwell Automation, ArmorBlock, and TechConnect are trademarks of Rockwell Automation, Inc. Trademarks not belonging to Rockwell Automation are property of their respective companies.

Rockwell Automation maintains current product environmental information on its website at <http://www.rockwellautomation.com/rockwellautomation/about-us/sustainability-ethics/product-environmental-compliance-page>.

Rockwell Otomasyon Ticaret A.Ş., Kar Plaza İş Merkezi E Blok Kat:6 34752 İçerenköy, İstanbul, Tel: +90 (216) 5698400

www.rockwellautomation.com

Power, Control and Information Solutions Headquarters

Americas: Rockwell Automation, 1201 South Second Street, Milwaukee, WI 53204-2496 USA, Tel: (1) 414.382.2000, Fax: (1) 414.382.4444
Europe/Middle East/Africa: Rockwell Automation NV, Pegasus Park, De Kleetlaan 12a, 1831 Diegem, Belgium, Tel: (32) 2 663 0600, Fax: (32) 2 663 0640
Asia Pacific: Rockwell Automation, Level 14, Core F, Cyberport 3, 100 Cyberport Road, Hong Kong, Tel: (852) 2887 4788, Fax: (852) 2508 1846

Publication 1732E-IN004D-EN-E - March 2017

Supersedes Publication 1732E-IN004C-EN-E May 2012

Copyright © 2017 Rockwell Automation, Inc. All rights reserved.