

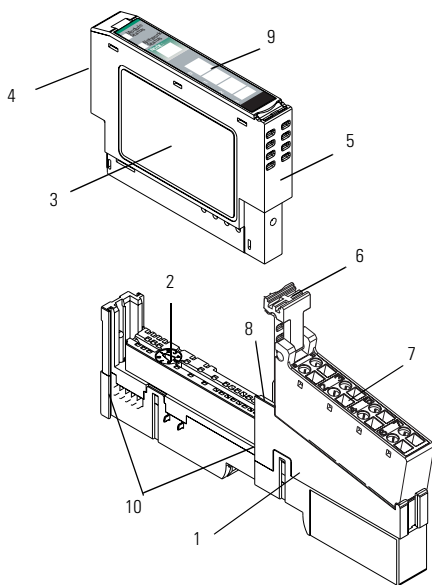

Installation Instructions

POINT I/O 2 Current Output Analog Module

(Cat. No. 1734-OE2C Series B)



	Description		Description
1	Mounting Base ¹	6	RTB Removal Handle
2	Mechanical Keying (orange)	7	Removable Terminal Block (RTB) ¹
3	Module Wiring Diagram	8	DIN Rail Locking Screw (orange)
4	Module Locking Mechanism	9	Slide-in Writable Label
5	Insertable I/O Module	10	Interlocking Side Pieces

¹ Wiring Base Assembly consists of item 1) mounting base, 1734-MB and item 7) removable terminal block, 1734-RT or -RTS.

Installing the Mounting Base

To install the mounting base on the DIN rail, proceed as follows.

- 1.** Position the mounting base vertically above the installed units (adapter, power supply or existing module).
- 2.** Slide the mounting base down allowing the interlocking side pieces to engage the adjacent module or adapter.
- 3.** Press firmly to seat the mounting base on the DIN rail. The mounting base will snap into place.
- 4.** To remove the mounting base from the DIN rail, remove the module, and use a small bladed screwdriver to rotate the base locking screw to a vertical position. This releases the locking mechanism. Then lift straight up to remove.

Installing the I/O Module

The module can be installed before, or after base installation. Make sure that the mounting base is correctly keyed before installing the module into the mounting base. In addition, make sure the mounting base locking screw is positioned horizontal referenced to the base.

- 1.** Using a bladed screwdriver, rotate the keyswitch (2) on the mounting base clockwise until the number required for the type of module being installed aligns with the notch in the base.
- 2.** Make certain the DIN rail locking screw is in the horizontal position. (You cannot insert the module if the locking mechanism is unlocked.)
- 3.** Insert the module straight down into the mounting base and press to secure. The module will lock into place.

Installing the Removable Terminal Block (RTB)

A removable terminal block is supplied with your wiring base assembly. To remove, pull up on the RTB handle. This allows the mounting base to be removed and replaced as necessary without removing any of the wiring. To reinsert the removable terminal block, proceed as follows.

- 1.** Insert the end opposite the handle into the base unit. This end has a curved section that engages with the wiring base.
- 2.** Rotate the terminal block into the wiring base until it locks itself in place.
- 3.** If an I/O module is installed, snap the RTB handle into place on the module.

Removing a Mounting Base

To remove a mounting base, you must remove any installed module, and remove the removable terminal block (if wired).

- 1.** Unlatch the RTB handle on the I/O module.
- 2.** Pull on the RTB handle to remove the removable terminal block.
- 3.** Press on the module lock on the top of the module.
- 4.** Pull on the I/O module to remove from the base.
- 5.** Use a small bladed screwdriver to rotate the orange base locking screw to a vertical position. This releases the locking mechanism.
- 6.** Then lift straight up to remove.

European Communities (EC) Directive Compliance

If this product has the CE mark it is approved for installation within the European Union and EEA regions. It has been designed and tested to meet the following directives.

EMC Directive

This product is tested to meet the Council Directive 89/336/EC Electromagnetic Compatibility (EMC) by applying the following standards, in whole or in part, documented in a technical construction file:

- EN 50081-2 EMC — Generic Emission Standard, Part 2 — Industrial Environment
- EN 50082-2 EMC — Generic Immunity Standard, Part 2 — Industrial Environment

This product is intended for use in an industrial environment.

Low Voltage Directive

This product is tested to meet Council Directive 73/23/EEC Low Voltage, by applying the safety requirements of EN 61131-2 Programmable Controllers, Part 2 - Equipment Requirements and Tests. For specific information required by EN 61131-2, see the appropriate sections in this publication, as well as the Allen-Bradley “Industrial Automation Wiring and Grounding Guidelines,” publication 1770-4.1.

Open style devices must be provided with environmental and safety protection by proper mounting in enclosures designed for specific application conditions. See NEMA Standards publication 250 and IEC publication 529, as applicable, for explanations of the degrees of protection provided by different types of enclosures.

Communicating with Your Module

I/O messages are sent to (consumed) and received from (produced) the POINT I/O modules. These messages are mapped into the processor's memory. This POINT I/O output module produces 2 bytes of input data (scanner Rx) (fault status). It consume 4 bytes of Output data (scanner Tx).

Default Data Map for the 1734-OE2C Analog Output Module

Message size: 2 Byte

	15	14	13	12	11	10	09	08	07	06	05	04	03	02	01	00
Produces (scanner Rx)	High Byte - Channel 1 Status							Low Byte - Channel 0 Status								
	Not used				H C A	L C A	C M	C F	Not used				H C A	L C A	C M	C F

Where: CF = Channel Fault status; 0 = no error, 1 = fault
 CM = Calibration Mode; 0 = Normal, 1 = calibration mode
 LCA = Low Clamp Alarm; 0 = no error, 1 = fault
 HCA = High Clamp Alarm; 0 = no error, 1 = fault

Message size: 4 bytes

	15	14	13	12	11	10	09	08	07	06	05	04	03	02	01	00
Consumes (scanner Tx)	Output Channel 0 High Byte							Output Channel 0 Low Byte								
	Output Channel 1 High Byte							Output Channel 1 Low Byte								

Wiring the Current Output Analog Module

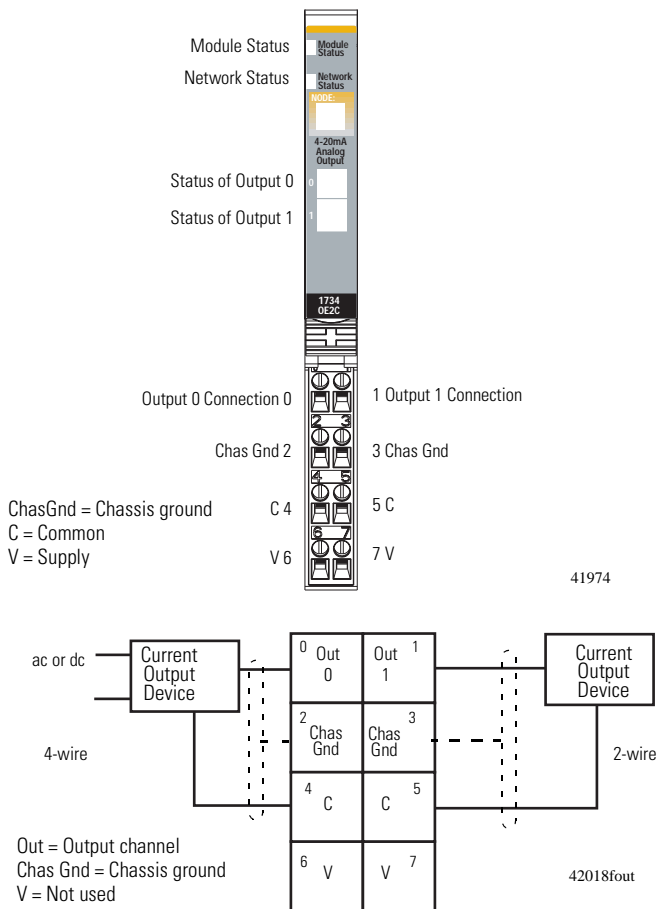

Channel	Current Output	Common	Chassis Ground	Supply
0	0	4	2	6
1	1	5	3	7

12/24V dc power is provided by the internal power bus.

Troubleshooting with the Indicators

Module Status

Network Status

Status of Output 0

Status of Output 1

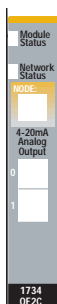









Indication	Probable Cause
Module Status	
Off	No power applied to device
Green	Device operating normally
Flashing Green	Device needs commissioning due to configuration missing, incomplete or incorrect.
Flashing Red	Recoverable fault.
Red	Unrecoverable fault may require device replacement
Flashing Red/Green	Device is in self-test

Indication	Probable Cause
Network Status	
Off	Device is not on-line - Device has not completed dup_MAC_id test. - Device not powered - check module status indicator
Flashing Green	Device is on-line but has no connections in the established state.
Green	Device on-line and has connections in the established state.
Flashing Red	One or more I/O connections in timed-out state
Red	Critical link failure - failed communication device. Device detected error that prevents it communicating on the network.
Flashing Red/Green	Communication faulted device - the device has detected a network access error and is in communication faulted state. Device has received and accepted an Identify Communication Faulted Request - long protocol message.

Indication	Probable Cause
Channel Status	
Off	Module in CAL mode.
Solid Green	Channel actively controlling outputs.
Blinking Green	Channel calibrating.
Blinking Red	Open wire, or no power.

Safety Approval

C-UL and UL Hazardous Location Approval	Approbation d'utilisation dans des environnements dangereux par la C-UL/UL
<p>C-UL and UL certifies products for general use as well as for use in hazardous locations. Actual C-UL and UL certification is indicated by the product label as shown below, and not by statements in any user documentation.</p>	<p>La C-UL/UL certifie des produits pour une utilisation générale aussi bien que pour une utilisation en environnements dangereux. La certification C-UL/UL en vigueur est indiquée par l'étiquette produit et non par des indications dans la documentation utilisateur.</p>
<p>Example of the C-UL and UL certification product label:</p> <div style="display: flex; justify-content: space-around; align-items: center;"> <div style="text-align: center;"> <p>LISTED</p>  </div> <div style="text-align: center;"> <p>CL I, DIV 2 GP A, B, C, D TEMP</p>  </div> </div>	<p>Exemple d'étiquette de certification d'un produit par la C-UL/UL :</p> <div style="display: flex; justify-content: space-around; align-items: center;"> <div style="text-align: center;"> <p>LISTED</p>  </div> <div style="text-align: center;"> <p>CL I, DIV 2 GP A, B, C, D TEMP</p>  </div> </div>
<p>To comply with C-UL and UL certification for use in hazardous locations, the following information becomes a part of the product literature for this C-UL and UL-certified industrial control product.</p> <ul style="list-style-type: none"> This equipment is suitable for use in Class I, Division 2, Groups A, B, C, D, or non-hazardous locations only. The products having the appropriate C-UL and UL markings (that is, Class I, Division 2, Groups A, B, C, D) are certified for use in other equipment where the suitability of combination (that is, application or use) is determined by the C-UL and UL or the local inspection office having jurisdiction 	<p>Pour satisfaire à la certification C-UL/UL en environnements dangereux, les informations suivantes font partie intégrante de la documentation des produits de commande industrielle certifiés.</p> <ul style="list-style-type: none"> Cet équipement ne convient qu'à une utilisation en environnements de Classe I, Division 2, Groupes A, B, C, D ou non dangereux. Les produits portant le marquage C-UL/UL approprié (c'est-à-dire Classe I, Division 2, Groupes A, B, C, D) sont certifiés pour une utilisation avec d'autres équipements, les combinaisons d'applications et d'utilisations étant déterminées par la C-UL/UL ou le bureau local d'inspection qualifié.
<p>Important: Due to the modular nature of a programmable control system, the product with the highest temperature rating determines the overall temperature code rating of a programmable control system in a Class I, Division 2, location. The temperature code rating is marked on the product label as shown. Operating temperature range is 0° - 55°C.</p>	<p>Important: De par la nature modulaire des systèmes de commande programmables, le produit ayant le code de température le plus élevé détermine le code de température global du système dans un environnement de Classe I, Division 2. Le code de température est indiqué sur l'étiquette produit.</p>
<p>Temperature code rating:</p> <div style="display: flex; justify-content: space-around; align-items: center;"> <div style="text-align: center;"> <p>LISTED</p>  <p>Look for temperature code rating here.</p> </div> <div style="text-align: center;"> <p>CL I, DIV 2 GP A, B, C, D TEMP</p>  </div> </div>	<p>Code de température :</p> <div style="display: flex; justify-content: space-around; align-items: center;"> <div style="text-align: center;"> <p>LISTED</p>  <p>Le code de température est indiqué ici.</p> </div> <div style="text-align: center;"> <p>CL I, DIV 2 GP A, B, C, D TEMP</p>  </div> </div>
<p>The following warnings apply to products having C-UL and UL certification for use in hazardous locations.</p>	<p>Les avertissements suivants s'appliquent aux produits ayant la certification C-UL/UL pour une utilisation en environnements dangereux.</p>
<p>WARNING: Explosion Hazard</p> <ul style="list-style-type: none"> Substitution of components may impair suitability for Class I, Division 2. Do not replace components unless power has been switched off or the area is known to be non-hazardous. Do not disconnect equipment unless power has been switched off or the area is known to be non-hazardous. Do not disconnect connectors unless power has been switched off or the area is known to be non-hazardous. Secure any user-supplied connectors that mate to external circuits on this equipment by using screws, sliding latches, threaded connectors, or other means such that any connection can withstand a 15 Newton (3.4 lb.) separating force applied for a minimum of one minute. 	<p>AVERTISSEMENT : Risque d'explosion</p> <ul style="list-style-type: none"> La substitution de composants peut rendre ce matériel inadapté à une utilisation en environnements de Classe I, Division 2. Couper le courant ou s'assurer que l'environnement est classé non dangereux avant de remplacer des composants. Couper le courant ou s'assurer que l'environnement est classé non dangereux avant de débrancher l'équipement. Couper le courant ou s'assurer que l'environnement est classé non dangereux avant de débrancher les connecteurs. Fixer tous les connecteurs fournis par l'utilisateur pour se brancher aux circuits externes de cet équipement à l'aide de vis, loquets coulissants, connecteurs filetés ou autres, de sorte que les connexions résistent à une force de séparation de 15 Newtons (1,5 kg - 3,4 lb.) appliquée pendant au moins une minute. S'assurer que l'environnement est classé non dangereux avant de changer les piles.
<p>C-UL and UL logo is a registered trademark of the Underwriters Laboratories.</p>	<p>Les sigles C-UL et UL sont des marques déposées de la Underwriters Laboratories.</p>

Specifications

Specifications - 1734-OE2C Current Output Analog Module

Output Specifications

Number of Outputs	2 single-ended, non-isolated
Resolution Current	13 bits over 0-21mA 5.13 μ A/cnt
Output Current Terminal	0mA output until communication established 4-20mA user configurable 0-20mA user configurable
Absolute Accuracy ¹ Current Terminal	0.1% Full Scale @ 25°C
Accuracy Drift w/Temp. Current Terminal	30ppm/°C
Resistive Load on mA Output	0-330 Ω
Conversion Type	Digital to analog converter
Conversion Rate	16 μ s
Data Format	Signed Integer
Calibration	Factory calibrated
Step Response to 63% of FS	24 μ s
Indicators	1 green/red network status indicator, logic side 1 green/red module status indicator, logic side 2 green/red output status indicators, logic side
Keyswitch Position	4

General Specifications

Module Location	1734-TB and -TBS
Pointbus Current	75mA @ 5V dc
Power Dissipation	Maximum 3W @ 28.8V dc
Thermal Dissipation	10.0 BTU/hr maximum @ 28.8V dc
Isolation Voltage	1250V rms/V ac tested at 2200V dc for 1s between user and system No isolation between individual channels
External dc Power Supply Voltage Voltage Range Supply Current	24V dc nominal 10-28.8V dc (includes 5% ac ripple) 50mA @ 24V dc (including outputs @ 20mA)
Dimensions Inches (Millimeters)	2.21H x 0.47W x 2.97L (56H x 12W x 75.5L)

Environmental Conditions		
Operational Temperature		-20 to 55°C (-4 to 131°F)
Storage Temperature		-40 to 85°C (-40 to 185°F)
Relative Humidity		5 to 95% noncondensing
Shock	Operating	12g peak acceleration, 11(±1)ms pulse width
	Non-operating	50g peak acceleration, 11(±1)ms pulse width
Vibration		Tested 2g @ 10-500Hz per IEC 68-2-6
Conductors	Wire Size	14 AWG (2.5mm ²) - 22 AWG (0.25mm ²) solid or stranded wire rated @ 75°C or greater
	Category	3/64 inch (1.2mm) insulation maximum 2 ²
Terminal Base Screw Torque		7 pound-inches (0.6Nm)
Field Wiring Terminations		0 - Output 0 1 - Output 1 2 - Ground 3 - Ground 4 - Common 5 - Common 6 - Supply 7 - Supply
Mass		1.26 oz/35.7 grams
Agency Certification (when product is marked)		C-UL Listed C-UL Class I, Division 2, Groups A, B, C and D certified UL Listed CE marked for all applicable directives. C-Tick marked for all applicable acts. DeviceNet compatible as certified by ODVA, Inc.

1 Includes offset, gain, non-linearity and repeatability error terms.

2 Use this conductor category information for planning conductor routing as described in publication 1770-4.1, "Industrial Automation Wiring and Grounding Guidelines."

Reach us now at www.rockwellautomation.com

Wherever you need us, Rockwell Automation brings together leading brands in industrial automation including Allen-Bradley controls, Reliance Electric power transmission products, Dodge mechanical power transmission components, and Rockwell Software. Rockwell Automation's unique, flexible approach to helping customers achieve a competitive advantage is supported by thousands of authorized partners, distributors and system integrators around the world.

Americas Headquarters, 1201 South Second Street, Milwaukee, WI 53204, USA, Tel: (1) 414 382-2000, Fax: (1) 414 382-4444
European Headquarters SA/IV, avenue Hermann Dieroux, 46, 1160 Brussels, Belgium, Tel: (32) 2 663 06 00, Fax: (32) 2 663 06 40
Asia Pacific Headquarters, 27/F Citicorp Centre, 16 Whitfield Road, Causeway Bay, Hong Kong, Tel: (852) 2987 4788, Fax: (852) 2508 1846



**Rockwell
Automation**

Publication 1734-IN054C-EN-P - August 2000

Supersedes Publication 1734-5.4 - October 1999

PN 957395-08

© 2000 Rockwell International Corporation. Printed in USA