

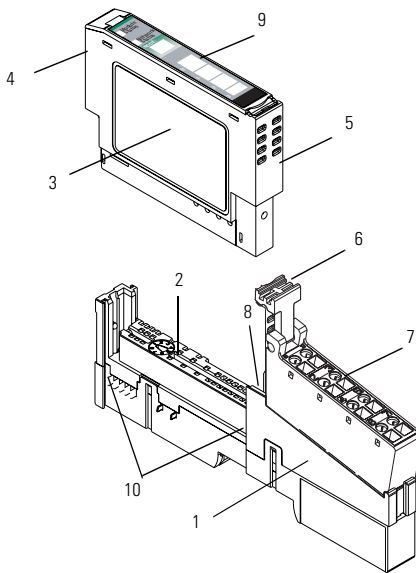

## Installation Instructions

# POINT I/O Protected Sink Output Module

(Cat. No. 1734-OV2E and -OV4E, Series C)



31830GM

	Description		Description
1	Mounting Base <sup>1</sup>	6	RTB Removal Handle
2	Mechanical Keying (orange)	7	Removable Terminal Block (RTB) <sup>1</sup>
3	Module Wiring Diagram	8	DIN Rail Locking Screw (orange)
4	Module Locking Mechanism	9	Slide-in Writable Label
5	Insertable I/O Module	10	Interlocking Side Pieces

<sup>1</sup> Wiring Base Assembly consists of item 1) mounting base, 1734-MB and item 7) removable terminal block, 1734-RT or -RTS.

**This Series C product can be used with DeviceNet and PROFIBUS adapters. It can be used with ControlNet and Ethernet adapters using RSLogix 5000, version 11 (or higher) software.**

### **Important User Information**

Because of the variety of uses for the products described in this publication, those responsible for the application and use of these products must satisfy themselves that all necessary steps have been taken to assure that each application and use meets all performance and safety requirements, including any applicable laws, regulations, codes and standards. In no event will Allen-Bradley be responsible or liable for indirect or consequential damage resulting from the use or application of these products.

Any illustrations, charts, sample programs, and layout examples shown in this publication are intended solely for purposes of example. Since there are many variables and requirements associated with any particular installation, Allen-Bradley does not assume responsibility or liability (to include intellectual property liability) for actual use based upon the examples shown in this publication.

Allen-Bradley publication SGI-1.1, *Safety Guidelines for the Application, Installation and Maintenance of Solid-State Control* (available from your local Allen-Bradley office), describes some important differences between solid-state equipment and electromechanical devices that should be taken into consideration when applying products such as those described in this publication.

Reproduction of the contents of this copyrighted publication, in whole or part, without written permission of Rockwell Automation, is prohibited.

Throughout this publication, notes may be used to make you aware of safety considerations. The following annotations and their accompanying statements help you to identify a potential hazard, avoid a potential hazard, and recognize the consequences of a potential hazard.

**WARNING**



Identifies information about practices or circumstances that can cause an explosion in a hazardous environment, which may lead to personal injury or death, property damage, or economic loss.

---

---

**ATTENTION**



Identifies information about practices or circumstances that can lead to personal injury or death, property damage, or economic loss.

---

---

**IMPORTANT**

Identifies information that is critical for successful application and understanding of the product.

---

**ATTENTION**



**Environment and Enclosure**

This equipment is intended for use in a Pollution Degree 2 industrial environment, in overvoltage Category II applications (as defined in IEC publication 60664-1), at altitudes up to 2000 meters without derating.

This equipment is considered Group 1, Class A industrial equipment according to IEC/CISPR Publication 11. Without appropriate precautions, there may be potential difficulties ensuring electromagnetic compatibility in other environments due to conducted as well as radiated disturbance.

This equipment is supplied as "open type" equipment. It must be mounted within an enclosure that is suitably designed for those specific environmental conditions that will be present and appropriately designed to prevent personal injury resulting from accessibility to live parts. The interior of the enclosure must be accessible only by the use of a tool. Subsequent sections of this publication may contain additional information regarding specific enclosure type ratings that are required to comply with certain product safety certifications.

See NEMA Standards publication 250 and IEC publication 60529, as applicable, for explanations of the degrees of protection provided by different types of enclosure. Also, see the appropriate sections in this publication, as well as the Allen-Bradley publication 1770-4.1 ("Industrial Automation Wiring and Grounding Guidelines"), for additional installation requirements pertaining to this equipment.

---

**ATTENTION**



POINT I/O is grounded through the DIN rail to chassis ground. Use zinc plated, yellow chromated steel DIN rail to assure proper grounding. Using other DIN rail materials (e.g. aluminum, plastic, etc.) which can corrode, oxidize or are poor conductors can result in improper or intermittent platform grounding.

---

**WARNING****EXPLOSION HAZARD**

- Do not disconnect equipment unless power has been removed or the area is known to be nonhazardous.
  - Do not disconnect connections to this equipment unless power has been removed or the area is known to be nonhazardous. Secure any external connections that mate to this equipment by using screws, sliding latches, threaded connectors, or other means provided with this product.
  - Substitution of components may impair suitability for Class I, Division 2.
  - If this product contains batteries, they must only be changed in an area known to be nonhazardous.
- 

**ATTENTION****Preventing Electrostatic Discharge**

This equipment is sensitive to electrostatic discharge, which can cause internal damage and affect normal operation. Follow these guidelines when you handle this equipment:

- Touch a grounded object to discharge potential static.
  - Wear an approved grounding wriststrap.
  - Do not touch connectors or pins on component boards.
  - Do not touch circuit components inside the equipment.
  - If available, use a static-safe workstation.
  - When not in use, store the equipment in appropriate static-safe packaging.
-

## Installing the Mounting Base

To install the mounting base on the DIN rail, proceed as follows.

1. Position the mounting base vertically above the installed units (adapter, power supply or existing module).
2. Slide the mounting base down allowing the interlocking side pieces to engage the adjacent module or adapter.
3. Press firmly to seat the mounting base on the DIN rail. The mounting base will snap into place.
4. To remove the mounting base from the DIN rail, remove the module, and use a small bladed screwdriver to rotate the base locking screw to a vertical position. This releases the locking mechanism. Then lift straight up to remove.

## Installing the I/O Module

The module can be installed before, or after base installation. Make sure that the mounting base is correctly keyed before installing the module into the mounting base. In addition, make sure the mounting base locking screw is positioned horizontal referenced to the base.

---

**WARNING**



When you insert or remove the module while backplane power is on, an electrical arc can occur. This could cause an explosion in hazardous location installations. Be sure that power is removed or the area is nonhazardous before proceeding.

- 
1. Using a bladed screwdriver, rotate the keyswitch (2) on the mounting base clockwise until the number required for the type of module being installed aligns with the notch in the base.
  2. Make certain the DIN rail locking screw is in the horizontal position. (You cannot insert the module if the locking mechanism is unlocked.)

3. Insert the module straight down into the mounting base and press to secure. The module will lock into place.

## Installing the Removable Terminal Block (RTB)

A removable terminal block is supplied with your wiring base assembly. To remove, pull up on the RTB handle. This allows the mounting base to be removed and replaced as necessary without removing any of the wiring. To reinsert the removable terminal block, proceed as follows.

1. Insert the end opposite the handle into the base unit. This end has a curved section that engages with the wiring base.
2. Rotate the terminal block into the wiring base until it locks itself in place.
3. If an I/O module is installed, snap the RTB handle into place on the module.

---

**WARNING**

When you connect or disconnect the Removable Terminal Block (RTB) with field side power applied, an electrical arc can occur. This could cause an explosion in hazardous location installations.

Be sure that power is removed or the area is nonhazardous before proceeding.

---

## Removing a Mounting Base

To remove a mounting base, you must remove any installed module, and remove the removable terminal block (if wired).

1. Unlatch the RTB handle on the I/O module.
2. Pull on the RTB handle to remove the removable terminal block.

---

**WARNING**



When you connect or disconnect the Removable Terminal Block (RTB) with field side power applied, an electrical arc can occur. This could cause an explosion in hazardous location installations.

Be sure that power is removed or the area is nonhazardous before proceeding.

---

3. Press on the module lock on the top of the module.
4. Pull on the I/O module to remove from the base.

---

**WARNING**



When you insert or remove the module while backplane power is on, an electrical arc can occur. This could cause an explosion in hazardous location installations. Be sure that power is removed or the area is nonhazardous before proceeding.

---

5. Use a small bladed screwdriver to rotate the orange base locking screw to a vertical position. This releases the locking mechanism.
6. Then lift straight up to remove.



## Communicating with Your Module

I/O messages are sent to (consumed) and received from (produced) the POINT I/O modules. These messages are mapped into the processor's memory. This POINT I/O output module produces 1 byte of input data (scanner Rx) (status). It consumes 1 byte of I/O data (scanner Tx).

### Default Data Map for the 1734-OV2E Output Module

Message size: 1 Byte

	7	6	5	4	3	2	1	0	
Produces (scanner Rx)	Not used						Ch1	Ch0	Channel status
Where: 0 = no error, 1 = error									

Message size: 1 Byte

	7	6	5	4	3	2	1	0	
Consumes (scanner Tx)	Not used						Ch1	Ch0	Channel state
Where: 0 = Off, 1 = On									

### Default Data Map for the 1734-OV4E Output Module

Message size: 1 Byte

	7	6	5	4	3	2	1	0	
Produces (scanner Rx)	Not used				Ch3	Ch2	Ch1	Ch0	Channel status
Where: 0 = no error, 1 = error									

Message size: 1 Byte

	7	6	5	4	3	2	1	0	
Consumes (scanner Tx)	Not used				Ch3	Ch2	Ch1	Ch0	Channel state
Where: 0 = Off, 1 = On									

## Wiring the Protected Sink Output Modules

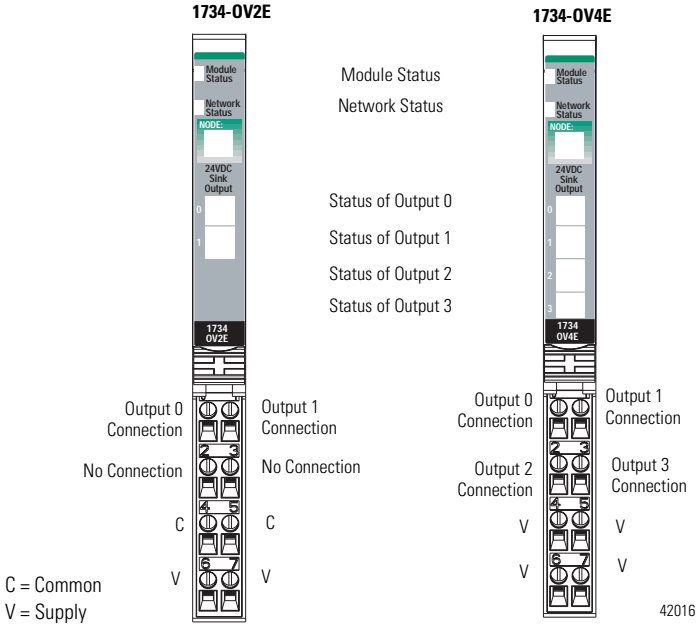

**dc Sink Output Module Cat. No. 1734-OV2E and -OV4E**

**1734-OV2E**

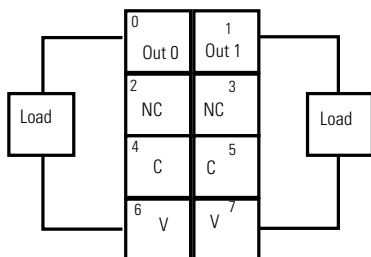

V = 12/24V dc, C = Common

Field power is supplied from internal power bus

42014

	<b>Output Terminal</b>	<b>Power</b>	<b>Common Terminal</b>
Channel 0	0	6	4
Channel 1	1	7	5

Module power is supplied from the internal power bus.

**1734-OV4E**

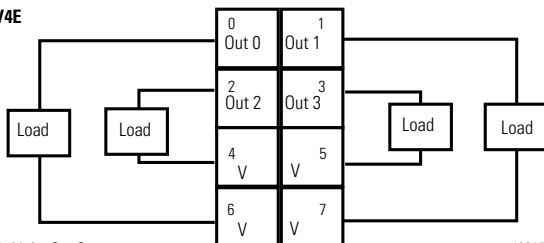

V = 12/24V dc, C = Common

Field power is supplied from internal power bus

42015

	<b>Output Terminal</b>	<b>Power</b>	<b>Common Terminal</b>
Channel 0	0	6	
Channel 1	1	7	
Channel 2	2	4	
Channel 3	3	5	

Module power is supplied from internal power bus.

## Troubleshooting with the Indicators

### 1734-OV2E



Module Status  
Network Status

Status of Output 0  
Status of Output 1  
Status of Output 2  
Status of Output 3

### 1734-OV4E

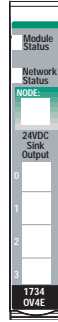



Indication	Probable Cause
<b>Module Status</b>	
Off	No power applied to device
Green	Device operating normally
Flashing Green	Device needs commissioning due to configuration missing, incomplete or incorrect.
Flashing Red	Recoverable fault.
Red	Unrecoverable fault may require device replacement
Flashing Red/Green	Device is in self-test

Indication	Probable Cause
<b>Network Status</b>	
Off	Device is not on-line - Device has not completed dup_MAC_id test. - Device not powered - check module status indicator
Flashing Green	Device is on-line but has no connections in the established state.
Green	Device on-line and has connections in the established state.
Flashing Red	One or more I/O connections in timed-out state
Red	Critical link failure - failed communication device. Device detected error that prevents it communicating on the network.
Flashing Red/Green	Communication faulted device - the device has detected a network access error and is in communication faulted state. Device has received and accepted an Identify Communication Faulted Request - long protocol message.

Indication	Probable Cause
<b>I/O Status</b>	
Off	All outputs inactive
Yellow	One or more output is active and under control
Red	Short circuit detected (On-State only)

## Safety Approvals

<p><b>The following information applies when operating this equipment in hazardous locations:</b></p>	<p><b>Informations sur l'utilisation de cet équipement en environnements dangereux:</b></p>
<p>Products marked "CL I, DIV 2, GP A, B, C, D" are suitable for use in Class I Division 2 Groups A, B, C, D, Hazardous Locations and nonhazardous locations only. Each product is supplied with markings on the rating nameplate indicating the hazardous location temperature code. When combining products within a system, the most adverse temperature code (lowest "T" number) may be used to help determine the overall temperature code of the system. Combinations of equipment in your system are subject to investigation by the local Authority Having Jurisdiction at the time of installation.</p>	<p>Les produits marqués "CL I, DIV 2, GP A, B, C, D" ne conviennent qu'à une utilisation en environnements de Classe I Division 2 Groupes A, B, C, D dangereux et non dangereux. Chaque produit est livré avec des marquages sur sa plaque d'identification qui indiquent le code de température pour les environnements dangereux. Lorsque plusieurs produits sont combinés dans un système, le code de température le plus défavorable (code de température le plus faible) peut être utilisé pour déterminer le code de température global du système. Les combinaisons d'équipements dans le système sont sujettes à inspection par les autorités locales qualifiées au moment de l'installation.</p>
<p><b>WARNING</b></p>  <p><b>EXPLOSION HAZARD -</b></p> <ul style="list-style-type: none"> <li>• Do not disconnect equipment unless power has been removed or the area is known to be nonhazardous.</li> <li>• Do not disconnect connections to this equipment unless power has been removed or the area is known to be nonhazardous. Secure any external connections that mate to this equipment by using screws, sliding latches, threaded connectors, or other means provided with this product.</li> <li>• Substitution of components may impair suitability for Class I, Division 2.</li> <li>• If this product contains batteries, they must only be changed in an area known to be nonhazardous.</li> </ul>	<p><b>AVERTISSEMENT</b></p>  <p><b>RISQUE D'EXPLOSION -</b></p> <ul style="list-style-type: none"> <li>• Couper le courant ou s'assurer que l'environnement est classé non dangereux avant de débrancher l'équipement.</li> <li>• Couper le courant ou s'assurer que l'environnement est classé non dangereux avant de débrancher les connecteurs. Fixer tous les connecteurs externes reliés à cet équipement à l'aide de vis, loquets coulissants, connecteurs filetés ou autres moyens fournis avec ce produit.</li> <li>• La substitution de composants peut rendre cet équipement inadapté à une utilisation en environnement de Classe 1, Division 2.</li> <li>• S'assurer que l'environnement est classé non dangereux avant de changer les piles.</li> </ul>

**Specifications - 1734-OV2E/C and -OV4E/C Protected Sink Output Modules****Output Specifications**

Number of Outputs	1734-OV2E - 2 (1 group of 2) non-isolated, sinking 1734-OV4E - 4 (1 group of 4) non-isolated, sinking
ON-State Voltage Range	10V dc minimum 24V dc nominal 28.8V dc maximum
ON-State Voltage Drop	0.7V dc maximum (at 28.8V dc, 55°C, full load condition)
ON-State Current	1.0mA minimum per channel 1.0A maximum per channel (electronically protected)
OFF-State Voltage	28.8V dc maximum
OFF-State Leakage	0.5mA maximum
Output Signal Delay <sup>1</sup> OFF to ON ON to OFF	0.1ms maximum 0.1ms maximum
Output Current Rating	Maximum 1.0A per output 2.0A maximum per module
Surge Current	2A for 10ms, repeatable every 3 seconds
Indicators (field side indication, logic driven)	<b>1734-OV2E</b> 2 yellow output status; 2 red output fault 2 green/red module/network status <b>1734-OV4E</b> 4 yellow output status; 4 red output fault 2 green/red module/network status
Keyswitch Position	1



**General Specifications**

Module Location	1734-TB or -TBS wiring base assembly
Pointbus Current	75mA maximum @ 5V dc
Power Dissipation	1734-OV2E - 2.0W maximum @ 28.8V dc 1734-OV4E - 2.9W maximum @ 28.8V dc
Thermal Dissipation	1734-OV2E - 6.8 BTU/hr maximum @ 28.8V dc 1734-OV4E - 9.9 BTU/hr maximum @ 28.8V dc
Isolation Voltage	50V continuous (Tested to 1250V ac for 60s between outputs and Pointbus)
External dc Power Supply Voltage Voltage Range Supply Current	24V dc nominal 10 to 28.8V dc 1734-OV2E - 8mA 1734-OV4E - 16mA
Dimensions Inches (Millimeters)	2.21H x 0.47W x 2.97L (56.0H x 12.0W x 75.5L)
Environmental Conditions	
Operational Temperature	IEC 60068-2-1 (Test Ad, Operating Cold), IEC 60068-2-2 (Test Bd, Operating Dry Heat), IEC 60068-2-14 (Test Nb, Operating Thermal Shock): -20 to 55°C (-4 to 131°F)
Storage Temperature	IEC 60068-2-1 (Test Ab, Unpackaged Nonoperating Cold), IEC 60068-2-2 (Test Bb, Unpackaged Nonoperating Dry Heat), IEC 60068-2-14 (Test Na, Unpackaged Nonoperating Thermal Shock): -40 to 85°C (-40 to 185°F)
Relative Humidity	IEC 60068-2-30 (Test Db, Unpackaged Nonoperating Damp Heat): 5 to 95% noncondensing
Shock Operating Non-operating	IEC 60068-2-27 (Test Ea, Unpackaged Shock) 30g peak acceleration 50g peak acceleration
Vibration	IEC 60068-2-6, (Test Fc, Operating) Tested 5g @ 10-500Hz
ESD Immunity	IEC 61000-4-2: 6kV contact discharges 8kV air discharges
Radiated RF Immunity	IEC 61000-4-3: 10V/m with 1kHz sine-wave 80%AM from 80MHz to 1000MHz 10V/m with 200Hz 50% Pulse 100%AM at 900Mhz

EFT/B Immunity	IEC 61000-4-4: ±2kV at 5kHz on signal ports																
Surge Transient Immunity	IEC 61000-4-5: ±1kV line-line(DM) and ±2kV line-earth(CM) on signal ports																
Conducted RF Immunity	IEC 61000-4-6: 10Vrms with 1kHz sine-wave 80%AM from 150kHz to 80MHz																
Emissions	CISPR 11 Group 1, Class A																
Enclosure Type Rating	None (open-style)																
Conductors Wire Size	14 AWG (2.5mm <sup>2</sup> ) - 22 AWG (0.25mm <sup>2</sup> ) solid or stranded copper wire rated at 75°C or greater																
Category	3/64 inch (1.2mm) insulation maximum 2 <sup>2</sup>																
Terminal Base Screw Torque	7 pound-inches (0.6Nm)																
Field Wiring Terminations	<p><b>1734-OV2E</b></p> <table> <tr> <td>0 - Output 0</td> <td>1 - Output 1</td> </tr> <tr> <td>2 - No connection</td> <td>3 - No connection</td> </tr> <tr> <td>4 - Common</td> <td>5 - Common</td> </tr> <tr> <td>6 - Supply</td> <td>7 - Supply</td> </tr> </table> <p><b>1734-OV4E</b></p> <table> <tr> <td>0 - Output 0</td> <td>1 - Output 1</td> </tr> <tr> <td>2 - Output 2</td> <td>3 - Output 3</td> </tr> <tr> <td>4 - Supply</td> <td>5 - Supply</td> </tr> <tr> <td>6 - Supply</td> <td>7 - Supply</td> </tr> </table>	0 - Output 0	1 - Output 1	2 - No connection	3 - No connection	4 - Common	5 - Common	6 - Supply	7 - Supply	0 - Output 0	1 - Output 1	2 - Output 2	3 - Output 3	4 - Supply	5 - Supply	6 - Supply	7 - Supply
0 - Output 0	1 - Output 1																
2 - No connection	3 - No connection																
4 - Common	5 - Common																
6 - Supply	7 - Supply																
0 - Output 0	1 - Output 1																
2 - Output 2	3 - Output 3																
4 - Supply	5 - Supply																
6 - Supply	7 - Supply																
Mass	1734-OV2E - 1.15 oz/32.60 grams 1734-OV4E - 1.17 oz/33.17 grams																

---

Agency Certification (when product is marked)

**C-UL-US** - UL Listed Industrial Control Equipment, certified for US and Canada

**C-UL-US** - UL Listed for Class I, Division 2, Groups A, B, C and D Hazardous locations, certified for US and Canada

**CE<sup>3</sup>** - European Union 89/336/EEC EMC Directive, compliant with:

EN 50081-2; Industrial Emissions

EN 50082-2; Industrial Immunity

EN 61326; Meas./Control/Lab., Industrial Requirements

EN 61000-6-2; Industrial Immunity

**C-Tick<sup>3</sup>** - Australian Radiocommunications Act compliant with AS/NZS 2064, Industrial Emissions

- 
- 1 Off/on delay is time from a valid output "on" signal to output energization. On/off delay is time from a valid output "off" signal to output deenergization.
  - 2 Use this conductor category information for planning conductor routing as described in publication 1770-4.1, "Industrial Automation Wiring and Grounding Guidelines."
  - 3 See the Product Certification link at [www.ab.com](http://www.ab.com) for Declaration of Conformity, Certificates, and other certification details.
-

---

Reach us now at [www.rockwellautomation.com](http://www.rockwellautomation.com)

Wherever you need us, Rockwell Automation brings together leading brands in industrial automation including Allen-Bradley controls, Reliance Electric power transmission products, Dodge mechanical power transmission components, and Rockwell Software. Rockwell Automation's unique, flexible approach to helping customers achieve a competitive advantage is supported by thousands of authorized partners, distributors and system integrators around the world.

**Americas Headquarters**, 1201 South Second Street, Milwaukee, WI 53204, USA, Tel: (1) 414 382-2000, Fax: (1) 414 382-4444  
**European Headquarters SA/IV**, avenue Hermann Dieroux, 46, 1160 Brussels, Belgium, Tel: (32) 2 663 06 00, Fax: (32) 2 663 06 40  
**Asia Pacific Headquarters**, 27/F Citicorp Centre, 16 Whitfield Road, Causeway Bay, Hong Kong, Tel: (852) 2987 4788, Fax: (852) 2508 1846



**Rockwell  
Automation**

Publication 1734-IN585B-EN-P - March 2002

Supersedes 1734-IN585A-EN-P - December 2001

PN 957657-95

© 2002 Rockwell International Corporation. Printed in USA