

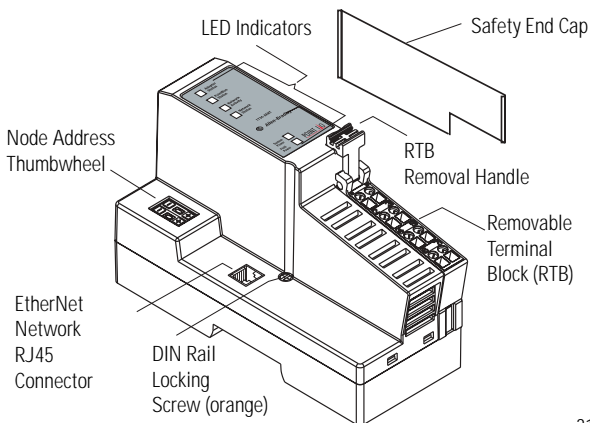

Installation Instructions

POINT I/O EtherNet/IP Adapter

Catalog Number 1734-AENT



31533-M

The POINT I/O EtherNet/IP Adapter is a communications adapter for POINT I/O modules. The adapter provides an interface for controlling and communicating with POINT I/O modules from an Ethernet network.

Allen-Bradley A

Important User Information

Because of the variety of uses for the products described in this publication, those responsible for the application and use of these products must satisfy themselves that all necessary steps have been taken to assure that each application and use meets all performance and safety requirements, including any applicable laws, regulations, codes and standards. In no event will Rockwell Automation be responsible or liable for indirect or consequential damage resulting from the use or application of these products.

Any illustrations, charts, sample programs, and layout examples shown in this publication are intended solely for purposes of example. Since there are many variables and requirements associated with any particular installation, Rockwell Automation does not assume responsibility or liability (to include intellectual property liability) for actual use based upon the examples shown in this publication.

Allen-Bradley publication SGI-1.1, *Safety Guidelines for the Application, Installation and Maintenance of Solid-State Control* (available from your local Rockwell Automation office), describes some important differences between solid-state equipment and electromechanical devices that should be taken into consideration when applying products such as those described in this publication.

Reproduction of the contents of this copyrighted publication, in whole or part, without written permission of Rockwell Automation, is prohibited.

Throughout this publication, notes may be used to make you aware of safety considerations. The following annotations and their accompanying statements help you to identify a potential hazard, avoid a potential hazard, and recognize the consequences of a potential hazard:

WARNING

Identifies information about practices or circumstances that can cause an explosion in a hazardous environment, which may lead to personal injury or death, property damage, or economic loss.

ATTENTION

Identifies information about practices or circumstances that can lead to personal injury or death, property damage, or economic loss.

IMPORTANT

Identifies information that is critical for successful application and understanding of the product.

BURN HAZARD

Labels may be located on or inside the equipment (e.g., drive or motor) to alert people that surfaces may be dangerous temperatures.

SHOCK HAZARD

Labels may be located on or inside the equipment (e.g., drive or motor) to alert people that dangerous voltage may be present.

Allen-Bradley A

ATTENTION



Environment and Enclosure

This equipment is intended for use in a Pollution Degree 2 industrial environment, in overvoltage Category II applications (as defined in IEC publication 60664-1), at altitudes up to 2000 meters without derating.

This equipment is considered Group 1, Class A industrial equipment according to IEC/CISPR Publication 11. Without appropriate precautions, there may be potential difficulties ensuring electromagnetic compatibility in other environments due to conducted as well as radiated disturbance.

This equipment is supplied as "open type" equipment. It must be mounted within an enclosure that is suitably designed for those specific environmental conditions that will be present and appropriately designed to prevent personal injury resulting from accessibility to live parts. The interior of the enclosure must be accessible only by the use of a tool. Subsequent sections of this publication may contain additional information regarding specific enclosure type ratings that are required to comply with certain product safety certifications.

See NEMA Standards publication 250 and IEC publication 60529, as applicable, for explanations of the degrees of protection provided by different types of enclosure. Also, see the appropriate sections in this publication, as well as the Allen-Bradley publication 1770-4.1 ("Industrial Automation Wiring and Grounding Guidelines"), for additional installation requirements pertaining to this equipment.

ATTENTION**Preventing Electrostatic Discharge**

This equipment is sensitive to electrostatic discharge, which can cause internal damage and affect normal operation. Follow these guidelines when you handle this equipment:

- Touch a grounded object to discharge potential static.
 - Wear an approved grounding wriststrap.
 - Do not touch connectors or pins on component boards.
 - Do not touch circuit components inside the equipment.
 - If available, use a static-safe workstation.
 - When not in use, store the equipment in appropriate static-safe packaging.
-

ATTENTION

POINT I/O is grounded through the DIN rail to chassis ground. Use zinc-plated, yellow-chromated steel DIN rail to assure proper grounding. Using other DIN rail materials (e.g., aluminum, plastic, etc.) which can corrode, oxidize or are poor conductors, can result in improper or intermittent platform grounding.

WARNING

When you connect or disconnect the Removable Terminal Block (RTB) with field side power applied, an electrical arc can occur. This could cause an explosion in hazardous location installations.

Be sure that power is removed or the area is nonhazardous before proceeding.

Before You Begin

To effectively use your adapter, note the following considerations.

Determine Compatibility

If using the 1734-AENT adapter with a 1756-ENBT module or 1788-ENBT module, use the following required firmware versions for these bridge modules:

- 1756-ENBT firmware version 2.3 or greater
- 1788-ENBT firmware version 1.33 or greater

If you use the BootP Utility to assign IP addresses to the adapter, use version 2.3.2 or greater.

Understand Messaging

Class 3 (Explicit Message) requests through the 1734-AENT adapter to a specific POINT I/O module may not always receive a response from the I/O modules. In the case where the I/O module does not reply to the request, the adapter responds with an error code indicating a time-out.

Establish I/O Connections

When you power up a POINT I/O system and establish I/O connections, the outputs transition to the Idle state, applying Idle state data before going to RUN mode. This occurs even when the controller making the connection is already in RUN mode.

Configure Autobaud

The adapter cannot reconfigure an I/O module that you previously configured to operate at a fixed baud rate. When you reuse a POINT I/O module from another POINT I/O system, configure the module to autobaud before using it with the adapter.

For More Information

The following related publications are available online at URL <http://literature.rockwellautomation.com>.

Publication Title	Publication Number
POINT I/O EtherNet/IP User Manual	1734-UM011
POINT I/O EtherNet/IP Adapter Release Notes	1734-RN002

Install the EtherNet/IP Adapter

To install the adapter on the DIN rail prior to installing other base units, proceed as follows.

1. Position the adapter vertically above the DIN rail.
2. Press down firmly to install the adapter on the DIN rail. The locking mechanism will lock the adapter to the DIN rail.
3. Set the node address on the node address thumbwheel.

WARNING

If you connect or disconnect the Ethernet cable with power applied to this module or any device on the network, an electrical arc can occur. This could cause an explosion in hazardous location installations.

Be sure that power is removed or the area is nonhazardous before proceeding.

Allen-Bradley A

- Slide the safety end cap up to remove. This exposes the backplane and power interconnections.

ATTENTION



Do not discard the end cap. Use this end cap to cover the exposed interconnections on the last mounting base on the DIN rail. Failure to do so could result in equipment damage or injury from electric shock.

Set the Network Address

The adapter ships with the thumbwheel switches set to 999 and DHCP enabled. You can set the network Internet Protocol (IP) address 3 ways:

- Use the thumbwheel switches on the module
- Use a Dynamic Host Configuration Protocol (DHCP) server, such as Rockwell Automation BootP/DHCP
- Retrieve the IP address from nonvolatile memory

Network Address
Thumbwheel
Press either the +
or - buttons to

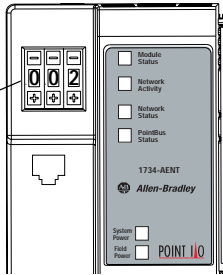

43248

The adapter reads the thumbwheel switches first to determine if the switches are set to a valid number. You set the node address using the 3-position thumbwheel switch. Press the + or - buttons to change the number. Valid settings range from 001 to 254. When the switches are set to a valid number, the adapter's IP address is 192.168.1.xxx (where xxx represents the number set on the switches). The adapter's

subnet mask is 255.255.255.0 and the gateway address is set to 0.0.0.0. The adapter does not have a host name assigned, or use any Domain Name System when using the thumbwheel settings.

If you set the switches to an invalid number (i.e. 000 or a value greater than 254), the adapter checks to see if you enabled DHCP, according to the following table.

If DHCP is	Then the adapter
Enabled	Asks for an address from a DHCP server. The DHCP server also assigns other Transport Control Protocol (TCP) parameters.
Not enabled	Uses the IP address (along with other TCP configurable parameters) stored in nonvolatile memory

Refer to publication 1734-UM011, POINT I/O EtherNet/IP Adapter User Manual, for more information.

Install a Replacement EtherNet/IP Adapter to an Existing System

ATTENTION



You must use Series C POINT I/O modules with the 1734-AENT adapter. Series A or B POINT I/O modules do not work with this adapter.

1. Remove the existing adapter from the DIN rail as follows:
 - a. Disconnect the EtherNet connector from the adapter.
 - b. Pull up on the RTB removal handle to remove the terminal block.
 - c. Remove the adjacent module from its base.
 - d. Use a small bladed screwdriver to rotate the DIN rail locking screw to a vertical position. This releases the locking mechanism.
 - e. Lift straight up to remove.

2. Slide the safety end cap up to remove. This exposes the backplane and power connections.
3. Position the replacement adapter vertically above the DIN rail. Make certain the DIN rail lock is in the horizontal position. Slide the adapter down, allowing the interlocking side pieces to engage the adjacent module.
4. Press firmly to seat the adapter on the DIN rail. The adapter locking mechanism will snap into place.
5. Set the node address on the node address thumbwheel.
6. Insert the end of the terminal block (RTB) opposite the handle into the base unit. This end has a curved section that engages with the wiring base.
7. Rotate the terminal block into the wiring base until it locks itself into place.
8. Replace the adjacent module in its base.
9. Reconnect the Ethernet cable to the adapter.
10. Set the IP Address for this module. Refer to the Setting the Network Address section of these instructions.

Wire the EtherNet/IP Adapter

WARNING



If you connect or disconnect wiring while the field-side power is on, an electrical arc can occur. this could cause an explosion in hazardous location installations.

Be sure that power is removed or the area is nonhazardous before proceeding.

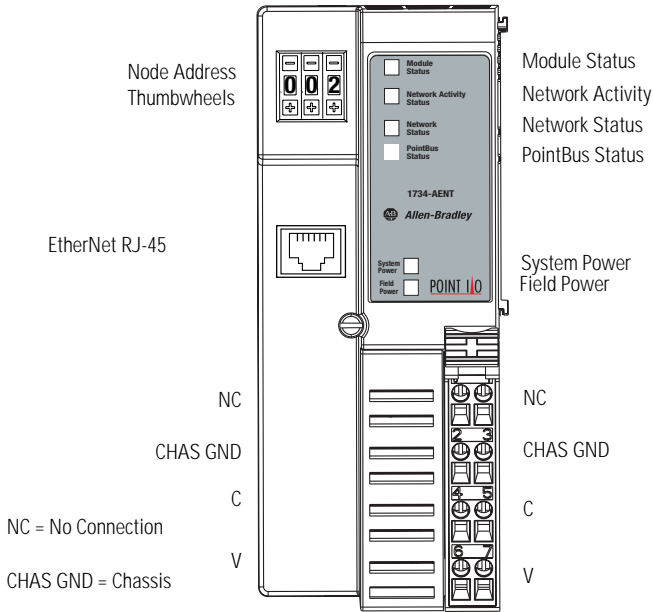

43264

12/24V dc

Do not connect 120/240V ac power to this supply.

This dc supply will be connected to the internal power bus.

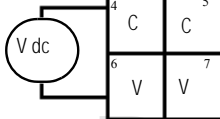

NC = No Connection
Chas GND = Chassis Ground
C = Common
V = Supply

Troubleshoot with the Indicators

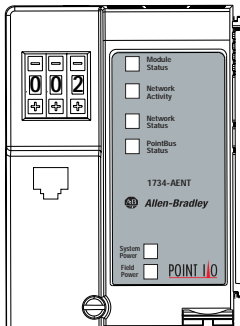

Module Status
 Network Activity
 Network Status
 PointBus Status

System Power
 Field Power

43248aent

Indication	Probable Cause
System Power	
Off	Not active; field power is off or dc-dc converter problem
Green	System power on; dc-dc converter active (5V)
Field Power	
Off	Not active; field power is off
Green	Power on; 24V present
Module Status	
Off	No power applied to device
Flashing Red/Green	LED powerup test (module self-test)
Green	Device is operating normally
Flashing Red	Recoverable fault has occurred: <ul style="list-style-type: none"> • Firmware (NVS) update • Network IP Address changed • CPU load exceeded
Solid Red	Unrecoverable fault has occurred: <ul style="list-style-type: none"> • Self-test failure (checksum failure, or ramtest failure at powerup) • Firmware fatal error

Indication	Probable Cause
Network Status	
Off	Device not initialized. The module does not have an IP address.
Flashing Green	No CIP connections. Device has an IP address, but no CIP connections are established.
Green	CIP connections. Device on-line and has an IP address, and CIP connections are established.
Flashing Red	One or more EtherNet connections has timed-out.
Red	No link. The module is not physically connected to a powered EtherNet Device.
Flashing Red/Green	The module is performing a self-test (only occurs during powerup test).
Network Activity	
Off	No link established.
Flashing Green/Off	Transmit or receive activity.
Steady Green	Link established.
PointBus Status	
Off	Device not powered - check module status indicator.
Flashing Red/Green	LED powerup test.
Flashing Red	Recoverable fault has occurred: <ul style="list-style-type: none"> • at powerup the number of expected modules does not equal the number of modules present • a module is missing • node fault (I/O connection timeout)

Allen-Bradley A

Red	Unrecoverable fault has occurred: <ul style="list-style-type: none">• the adapter is bus off• the adapter has failed its duplicate MAC ID check
Flashing Green	Adapter online with no connections established: <ul style="list-style-type: none">• adapter chassis size has not been configured• controller in program/idle mode• EtherNet cable open
Green	Adapter online with connections established (normal operation, run mode).

European Hazardous Location Approval

European Zone 2 Certification (The following applies when the product bears the EEx Marking)

This equipment is intended for use in potentially explosive atmospheres as defined by European Union Directive 94/9/EC.

DEMKO certifies that this equipment has been found to comply with the Essential Health and Safety Requirements relating to the design and construction of Category 3 equipment intended for use in potentially explosive atmospheres, given in Annex II to this Directive. The examination and test results are recorded in confidential report No 03NK30347.



Compliance with the Essential Health and Safety Requirements has been assured by compliance with EN 50021.

IMPORTANT

Observe the following additional Zone 2 certification requirements.

- This equipment is not resistant to sunlight or other sources of UV radiation.
 - The secondary of a current transformer shall not be open-circuited when applied in Class I, Zone 2 environments.
 - Equipment of lesser Enclosure Type Rating must be installed in an enclosure providing at least IP54 protection when applied in Class I, Zone 2 environments.
 - This equipment shall be used within its specified ratings defined by Allen-Bradley.
 - Provision shall be made to prevent the rated voltage from being exceeded by transient disturbances of more than 40% when applied in Class I, Zone 2 environments.
-

North American Hazardous Location Approval

<p>The following information applies when operating this equipment in hazardous locations:</p>	<p>Informations sur l'utilisation de cet équipement en environnements dangereux:</p>
<p>Products marked "CL I, DIV 2, GP A, B, C, D" are suitable for use in Class I Division 2 Groups A, B, C, D, Hazardous Locations and nonhazardous locations only. Each product is supplied with markings on the rating nameplate indicating the hazardous location temperature code. When combining products within a system, the most adverse temperature code (lowest "T" number) may be used to help determine the overall temperature code of the system. Combinations of equipment in your system are subject to investigation by the local Authority Having Jurisdiction at the time of installation.</p>	<p>Les produits marqués "CL I, DIV 2, GP A, B, C, D" ne conviennent qu'à une utilisation en environnements de Classe I Division 2 Groupes A, B, C, D dangereux et non dangereux. Chaque produit est livré avec des marquages sur sa plaque d'identification qui indiquent le code de température pour les environnements dangereux. Lorsque plusieurs produits sont combinés dans un système, le code de température le plus défavorable (code de température le plus faible) peut être utilisé pour déterminer le code de température global du système. Les combinaisons d'équipements dans le système sont sujettes à inspection par les autorités locales qualifiées au moment de l'installation.</p>
<p>WARNING</p>  <p>EXPLOSION HAZARD -</p> <ul style="list-style-type: none"> Do not disconnect equipment unless power has been removed or the area is known to be nonhazardous. Do not disconnect connections to this equipment unless power has been removed or the area is known to be nonhazardous. Secure any external connections that mate to this equipment by using screws, sliding latches, threaded connectors, or other means provided with this product. Substitution of components may impair suitability for Class I, Division 2. If this product contains batteries, they must only be changed in an area known to be nonhazardous. 	<p>AVERTISSEMENT</p>  <p>RISQUE D'EXPLOSION -</p> <ul style="list-style-type: none"> Couper le courant ou s'assurer que l'environnement est classé non dangereux avant de débrancher l'équipement. Couper le courant ou s'assurer que l'environnement est classé non dangereux avant de débrancher les connecteurs. Fixer tous les connecteurs externes reliés à cet équipement à l'aide de vis, loquets coulissants, connecteurs filetés ou autres moyens fournis avec ce produit. La substitution de composants peut rendre cet équipement inadapté à une utilisation en environnement de Classe 1, Division 2. S'assurer que l'environnement est classé non dangereux avant de changer les piles.

Specifications

Adapter Specifications

Expansion I/O Capacity	<p>Maximum of 63 modules Maximum of 5 Rack Optimized connections (for digital modules only) Maximum of 20 direct connections 1734-AENT backplane current output = 1.0A. The actual number of modules can vary. Add up the current requirements of the modules you want to use to make sure they do not exceed the amperage limit of 1.0A for the 1734-AENT. Backplane current can be extended beyond 1.0A by using 1734-EP24DC backplane extension Power Supplies. Add multiple 1734-EP24DC modules to reach the 63 module maximum).</p>																																																																		
	<table border="0"> <thead> <tr> <th data-bbox="326 526 512 551">Cat. No.</th> <th data-bbox="512 526 921 551">PointBus Current Requirements</th> </tr> </thead> <tbody> <tr><td>1734-IB2</td><td>75mA</td></tr> <tr><td>1734-IB4</td><td>75mA</td></tr> <tr><td>1734-IB8</td><td>75mA</td></tr> <tr><td>1734-IV2</td><td>75mA</td></tr> <tr><td>1734-IV4</td><td>75mA</td></tr> <tr><td>1734-OB2</td><td>75mA</td></tr> <tr><td>1734-OB4</td><td>75mA</td></tr> <tr><td>1734-OB8</td><td>75mA</td></tr> <tr><td>1734-OB2E</td><td>75mA</td></tr> <tr><td>1734-OB2EP</td><td>75mA</td></tr> <tr><td>1734-OB4E</td><td>75mA</td></tr> <tr><td>1734-OB8E</td><td>75mA</td></tr> <tr><td>1734-OV2E</td><td>75mA</td></tr> <tr><td>1734-OV4E</td><td>75mA</td></tr> <tr><td>1734-OW2</td><td>80mA</td></tr> <tr><td>1734-OX2</td><td>100mA</td></tr> <tr><td>1734-IE2C</td><td>75mA</td></tr> <tr><td>1734-OE2C</td><td>75mA</td></tr> <tr><td>1734-IE2V</td><td>75mA</td></tr> <tr><td>1734-OE2V</td><td>75mA</td></tr> <tr><td>1734-IA2</td><td>75mA</td></tr> <tr><td>1734-IM2</td><td>75mA</td></tr> <tr><td>1734-OA2</td><td>75mA</td></tr> <tr><td>1734-IJ2</td><td>160mA</td></tr> <tr><td>1734-IK2</td><td>160mA</td></tr> <tr><td>1734-IR2</td><td>220mA</td></tr> <tr><td>1734-IT2I</td><td>175mA</td></tr> <tr><td>1734-SSI</td><td>110mA</td></tr> <tr><td>1734-VHSC5</td><td>180mA</td></tr> <tr><td>1734-VHSC24</td><td>180mA</td></tr> <tr><td>1734-232ASC</td><td>75mA</td></tr> <tr><td>1734-485ASC</td><td>75mA</td></tr> </tbody> </table>	Cat. No.	PointBus Current Requirements	1734-IB2	75mA	1734-IB4	75mA	1734-IB8	75mA	1734-IV2	75mA	1734-IV4	75mA	1734-OB2	75mA	1734-OB4	75mA	1734-OB8	75mA	1734-OB2E	75mA	1734-OB2EP	75mA	1734-OB4E	75mA	1734-OB8E	75mA	1734-OV2E	75mA	1734-OV4E	75mA	1734-OW2	80mA	1734-OX2	100mA	1734-IE2C	75mA	1734-OE2C	75mA	1734-IE2V	75mA	1734-OE2V	75mA	1734-IA2	75mA	1734-IM2	75mA	1734-OA2	75mA	1734-IJ2	160mA	1734-IK2	160mA	1734-IR2	220mA	1734-IT2I	175mA	1734-SSI	110mA	1734-VHSC5	180mA	1734-VHSC24	180mA	1734-232ASC	75mA	1734-485ASC	75mA
Cat. No.	PointBus Current Requirements																																																																		
1734-IB2	75mA																																																																		
1734-IB4	75mA																																																																		
1734-IB8	75mA																																																																		
1734-IV2	75mA																																																																		
1734-IV4	75mA																																																																		
1734-OB2	75mA																																																																		
1734-OB4	75mA																																																																		
1734-OB8	75mA																																																																		
1734-OB2E	75mA																																																																		
1734-OB2EP	75mA																																																																		
1734-OB4E	75mA																																																																		
1734-OB8E	75mA																																																																		
1734-OV2E	75mA																																																																		
1734-OV4E	75mA																																																																		
1734-OW2	80mA																																																																		
1734-OX2	100mA																																																																		
1734-IE2C	75mA																																																																		
1734-OE2C	75mA																																																																		
1734-IE2V	75mA																																																																		
1734-OE2V	75mA																																																																		
1734-IA2	75mA																																																																		
1734-IM2	75mA																																																																		
1734-OA2	75mA																																																																		
1734-IJ2	160mA																																																																		
1734-IK2	160mA																																																																		
1734-IR2	220mA																																																																		
1734-IT2I	175mA																																																																		
1734-SSI	110mA																																																																		
1734-VHSC5	180mA																																																																		
1734-VHSC24	180mA																																																																		
1734-232ASC	75mA																																																																		
1734-485ASC	75mA																																																																		
EtherNet Communication Rate	10/100Mbps/s, half or full-duplex																																																																		

Module Location	Starter module - left side of the 1734 system
Power Supply Specifications	
Input Voltage Rating	24V dc nominal 10-28.8V dc range
Field Side Power Requirements	24V dc (+20% = 28.8V dc maximum) @ 400mA maximum
Inrush Current	6A maximum for 10ms
Interruption	Output voltage will stay within specifications when input drops out for 10ms at 10V with maximum load.
General Specifications	
Indicators	4 red/green status indicators Adapter status PointBus status Network activity status Network status 2 green power supply status indicators: System Power (PointBus 5V power) Field Power (24V from field supply)
Power Consumption	4.5W maximum @ 28.8V dc
Power Dissipation	15.5W maximum @ 28.8V
PointBus Output Current	1A maximum @ 5V dc $\pm 5\%$ (4.75 - 5.25)
Input Overvoltage Protection	Reverse polarity protected
Thermal Dissipation	9.5 BTU/hr maximum @ 28.8V dc
Isolation Voltage	Tested to withstand 1800V dc for 60s
Field Power Bus Nominal Voltage Supply Voltage Range Supply Current	24V dc 10-28.8V dc range 10A maximum
Dimensions Inches (Millimeters)	3.0H x 2.16W x 5.25L (76.2H x 54.9W x 133.4L)

Allen-Bradley A

18 POINT I/O EtherNet/IP Adapter

Environmental Conditions	
Operational Temperature	IEC 60068-2-1 (Test Ad, Operating Cold), IEC 60068-2-2 (Test Bd, Operating Dry Heat), IEC 60068-2-14 (Test Nb, Operating Thermal Shock): -20 to 55° C (-4 to 131° F)
Storage Temperature	IEC 60068-2-1 (Test Ab, Unpackaged Nonoperating Cold), IEC 60068-2-2 (Test Bb, Unpackaged Nonoperating Dry Heat), IEC 60068-2-14 (Test Na, Unpackaged Nonoperating Thermal Shock): -40 to 85° C (-40 to 185° F)
Relative Humidity	IEC 60068-2-30 (Test Db, Unpackaged Nonoperating Damp Heat): 5 to 95% noncondensing
Shock	IEC 60068-2-27 (Test Ea, Unpackaged Shock)
Operating	30g peak acceleration
Nonoperating	50g peak acceleration
Vibration	IEC 60068-2-6 (Test Fc, Operating) Tested 5g @ 10-500Hz
ESD Immunity	IEC 61000-4-2: 6kV contact discharges 8kV air discharges
Radiated RF Immunity	IEC 61000-4-3: 10V/m with 1kHz sine-wave 80%AM from 30MHz to 2000MHz 10V/m with 200Hz 50% pulse 100%AM from 900MHz
EFT/B Immunity	IEC 61000-4-4: ±4kV at 5.0kHz on power ports ±2kV at 5.0kHz on communications ports
Surge Transient Immunity	IEC 61000-4-5: ±1kV line-line(DM) and ±2kV line-earth(CM) on communications ports ±1kV line-line(DM) and ±2kV line-earth(CM) on power ports
Conducted RF Immunity	IEC 61000-4-6: 10Vrms with 1kHz sine-wave 80%AM from 150kHz to 80MHz
Emissions	CISPR 11 Group 1, Class A
Enclosure Type Rating	None (open-style)

Conductors	14-22 AWG (2.5-0.25mm ²) solid or stranded wire rated at 75°C or higher
Wire Size	3/64 inch (1.2mm) insulation maximum
Wiring Category ^{1,2}	1 - on power ports 2 - on communications ports
EtherNet Connector	RJ-45, Category 5
Terminal Base Screw Torque	7 pound-inches (0.8Nm)
Mass	9.0 oz/255 grams
Certifications ³ (when product is marked)	<p>C-UL-US UL Listed for Class I, Division 2, Groups A, B, C and D Hazardous locations, certified for US and Canada</p> <p>EEx European Union 94/9/EC ATEX Directive, compliant with: EN 50021; Potentially Explosive Atmospheres, Protection "n" (Zone 2)</p> <p>CE European Union 89/336/EEC EMC Directive, compliant with: EN 61000-6-4; Industrial Emissions EN 50082-2; Industrial Immunity EN 61326; Meas./Control/Lab., Industrial Requirements EN 61000-6-2; Industrial Immunity</p> <p>C-Tick Australian Radiocommunications Act, compliant with: AS/NZS CISPR 11; Industrial Emissions</p> <p>EtherNet/IP ODVA conformance tested to EtherNet/IP specifications</p>

- 1 Use this conductor category information for planning conductor routing as described in publication 1770-4.1, "Industrial Automation Wiring and Grounding Guidelines."
- 2 Use the Conductor Category information for planning conductor routing as described in the appropriate System Level Installation Manual.
- 3 See the Product Certification link at www.ab.com for Declarations of Conformity, Certificates, and other certification details.

POINT I/O is a trademark of Rockwell Automation.

EtherNet/IP is a trademark of ControlNet International under license by ODVA.

Allen-Bradley A

Rockwell Automation Support

Rockwell Automation provides technical information on the web to assist you in using its products. At <http://support.rockwellautomation.com>, you can find technical manuals, a knowledge base of FAQs, technical and application notes, sample code and links to software service packs, and a MySupport feature that you can customize to make the best use of these tools.

For an additional level of technical phone support for installation, configuration and troubleshooting, we offer TechConnect Support programs. For more information, contact your local distributor or Rockwell Automation representative, or visit <http://support.rockwellautomation.com>.

Installation Assistance

If you experience a problem with a hardware module within the first 24 hours of installation, please review the information that's contained in this manual. You can also contact a special Customer Support number for initial help in getting your module up and running:

United States	1.440.646.3223 Monday – Friday, 8am – 5pm EST
Outside United States	Please contact your local Rockwell Automation representative for any technical support issues.

New Product Satisfaction Return

Rockwell tests all of its products to ensure that they are fully operational when shipped from the manufacturing facility. However, if your product is not functioning and needs to be returned:

United States	Contact your distributor. You must provide a Customer Support case number (see phone number above to obtain one) to your distributor in order to complete the return process.
Outside United States	Please contact your local Rockwell Automation representative for return procedure.

www.rockwellautomation.com

Corporate Headquarters

Rockwell Automation, 777 East Wisconsin Avenue, Suite 1400, Milwaukee, WI 53202-5302 USA, Tel: (1) 414.212.5200, Fax: (1) 414.212.5201

Headquarters for Allen-Bradley Products, Rockwell Software Products and Global Manufacturing Solutions

Americas: Rockwell Automation, 1201 South Second Street, Milwaukee, WI 53204-2496 USA, Tel: (1) 414.382.2000, Fax: (1) 414.382.4444
Europe/Middle East/Africa: Rockwell Automation SA/NV, Vorstlaan/Boulevard du Souverain 36, 1170 Brussels, Belgium, Tel: (32) 2 663 0600, Fax: (32) 2 663 0600
Asia Pacific: Rockwell Automation, Level 14, Core F, Cyberport 3, 100 Cyberport Road, Hong Kong, Tel: (852) 2887 4788, Fax: (852) 2508 1846

Headquarters for Dodge and Reliance Electric Products

Americas: Rockwell Automation, 6040 Ponders Court, Greenville, SC 29615-4617 USA, Tel: (1) 864.297.4800, Fax: (1) 864.281.2433
Europe/Middle East/Africa: Rockwell Automation, Herman-Heinrich-Gossen-Strasse 3, 50858 Köln, Germany, Tel: 49 (0) 2234 379410, Fax: 49 (0) 2234 3794164
Asia Pacific: Rockwell Automation, 55 Newton Road, #11-01/02 Revenue House, Singapore 307987, Tel: (65) 6356 9077, Fax: (65) 6356 9011

Publication 1734-IN590B-EN-P - February 2005

PN 957944-91

Supersedes Publication 1734-IN590A-EN-P - March 2003

Copyright © 2005 Rockwell Automation, Inc. All rights reserved. Printed in the U.S.A.