



Allen-Bradley

*SLC 500™
Thermocouple/mV
Input Module*

(Cat. No. 1746-NT4, Series B)

User Manual

Allen-Bradley Drives

Important User Information

Because of the variety of uses for the products described in this publication, those responsible for the application and use of this control equipment must satisfy themselves that all necessary steps have been taken to assure that each application and use meets all performance and safety requirements, including any applicable laws, regulations, codes and standards.

The illustrations, charts, sample programs and layout examples shown in this guide are intended solely for purposes of example. Since there are many variables and requirements associated with any particular installation, Allen-Bradley does not assume responsibility or liability (to include intellectual property liability) for actual use based upon the examples shown in this publication.

Allen-Bradley publication SGI-1.1, *Safety Guidelines for the Application, Installation, and Maintenance of Solid-State Control* (available from your local Allen-Bradley office), describes some important differences between solid-state equipment and electromechanical devices that should be taken into consideration when applying products such as those described in this publication.

Reproduction of the contents of this copyrighted publication, in whole or in part, without written permission of Allen-Bradley Company, Inc., is prohibited.

Throughout this manual we use notes to make you aware of safety considerations:



ATTENTION: Identifies information about practices or circumstances that can lead to personal injury or death, property damage or economic loss.

Attention statements help you to:

- identify a hazard
- avoid the hazard
- recognize the consequences

Important: Identifies information that is critical for successful application and understanding of the product.

Summary of Changes

The information below summarizes the changes to this manual since the last printing in February, 1995.

To help you find new information and updated information in this release of the manual, we have included change bars as shown to the right of this paragraph.

New Information

The table below lists sections that document new features and additional information about existing features, and shows where to find this new information.

| For This New Information | See |
|---|---|
| Terms and Abbreviations moved from Preface to Glossary | Preface – Contents of This Manual Table, Glossary |
| Module Operation | Chapter 1 – Overview |
| Thermocouple Compatibility | |
| Input Circuit Block Diagram (shield terminal now ANALOG COMMON) | |
| Strain Gage Bridge Circuit | |
| New modules have been added to the Fixed Controller Compatibility Table. | Chapter 3 – Installation and Wiring |
| Compliance to European Union Directives statement. | Chapter 3 – Installation and Wiring, Appendix A – Specifications |
| ANALOG COMMON, SHIELD, and CHASSIS GROUND wiring for Series B modules. | Chapter 3 – Installation and Wiring |
| Because users may employ different programming devices, references to Advanced Programming Software have been removed from this manual. | Preface – Related Documentation Table and/or your programming device's user manual. |

Preface

Read this preface to familiarize yourself with the rest of the manual. This preface covers the following topics:

- who should use this manual
- the purpose of this manual
- terms and abbreviations
- conventions used in this manual
- Allen-Bradley support

Who Should Use this Manual

Use this manual if you are responsible for the design, installation, programming, or maintenance of an automation control system that uses Allen-Bradley small logic controllers.

You should have a basic understanding of SLC 500 products. You should understand electronic process control and be able to interpret the ladder logic instructions required to generate the electronic signals that control your application.

If you do not, contact your local Allen-Bradley representative for the proper training before using this product.

Purpose of this Manual

This manual is a learning and reference guide for the 1746-NT4 Thermocouple/mV Input Module. It contains the information you need to install, wire, and use the module. It also provides diagnostic and troubleshooting help.

Allen-Bradley Drives

Contents of this Manual

| Chapter | Title | Content |
|------------|---|--|
| | Preface | Describes the purpose, background, and scope of this manual. Also specifies the audience for whom this manual is intended and gives directions to using Allen-Bradley support services. Provides listing of related documentation. |
| 1 | Overview | Provides a hardware and system overview. Explains and illustrates the theory behind the thermocouple input module. |
| 2 | Quick Start for Experienced Users | Serves as a <i>Quick Start Guide</i> for the experienced user. |
| 3 | Installation and Wiring | Provides installation information and wiring guidelines. |
| 4 | Preliminary Operating Considerations | Gives you the background information you need to understand how to address and configure the module for optimum operation as well as how to make changes once the module is in a run state. |
| 5 | Channel Configuration, Data, and Status | Examines the channel configuration word and the channel status word bit by bit, and explains how the module uses configuration data and generates status during operation. |
| 6 | Ladder Programming Examples | Gives an example of the ladder logic required to define the channel for operation. Also includes representative examples for unique programming requirements such as PID. |
| 7 | Module Diagnostics and Troubleshooting | Explains how to interpret and correct problems that may occur while using the thermocouple module. |
| 8 | Application Examples | Examines both basic and supplementary applications and gives examples of the ladder programming necessary to achieve the desired result. |
| Appendix A | Specifications | Provides physical, electrical, environmental, and functional specifications for the module. |
| Appendix B | NT4 Configuration Worksheet | Provides a worksheet to help you configure the module for operation. |
| Appendix C | Thermocouple Restrictions | Gives you information about certain thermocouples and the environment(s) in which they perform best. |
| Appendix D | Thermocouple Types | Describes the types of thermocouple junctions. |
| | Glossary | Lists key terms and abbreviations. |

Related Documentation

The following documents contain information that may be helpful to you as you use Allen-Bradley SLC products. To obtain a copy of any of the Allen-Bradley documents listed, contact your local Allen-Bradley office or distributor.

| For | Read This Document | Document Number |
|---|---|--|
| An overview of the SLC 500 family of products | SLC 500 System Overview | 1747-2.30 |
| A description on how to install and use your <i>Modular</i> SLC 500 programmable controller | Installation & Operation Manual for Modular Hardware Style Programmable Controllers | 1747-6.2 |
| A description on how to install and use your <i>Fixed</i> SLC 500 programmable controller | Installation & Operation Manual for Fixed Hardware Style Programmable Controllers | 1747-NI001 |
| A procedural manual for technical personnel who use APS to develop control applications | Allen-Bradley Advanced Programming Software (APS) User Manual | 1747-6.4 |
| A reference manual that contains status file data, instruction set, and troubleshooting information about APS | Allen-Bradley Advanced Programming Software (APS) Reference Manual | 1747-6.11 |
| An introduction to APS for first-time users, containing basic concepts but focusing on simple tasks and exercises, and allowing the reader to quickly begin programming | Getting Started Guide for APS | 1747-6.3 |
| A training and quick reference guide to APS | SLC 500 Software Programmer's Quick Reference Guide Using APS—available on PASSPORT, list price \$50.00 | ABT-1747-TSG001 |
| A training and quick reference guide to A.I. | SLC 500 Troubleshooting Guide Using A.I. Series—available on PASSPORT, list price \$50.00 | ABT-1747-TSJ21 |
| A common procedures guide to APS | SLC 500 Family Common Procedures Guide Using APS—available on PASSPORT, list price \$50.00 | ABT-1747-T550 |
| A common procedures guide to A.I. | SLC 500 Family Common Procedures Guide Using A.I. Series—available on PASSPORT, list price \$50.00 | ABT-1747-TSJ51 |
| A procedural and reference manual for technical personnel who use the APS import/export utility to convert APS files to ASCII and conversely ASCII to APS files | APS Import/Export User Manual | 1747-6.7 |
| A procedural and reference manual for technical personnel who use an HHT to develop control applications | Allen-Bradley Hand-Held Terminal User Manual | 1747-NP002 |
| An introduction to HHT for first-time users, containing basic concepts but focusing on simple tasks and exercises, and allowing the reader to quickly begin programming | Getting Started Guide for HHT | 1747-NM009 |
| A reference manual that contains status file data and instruction set information for the SLC 500 processors and MicroLogix 1000 controllers. | SLC 500/ MicroLogix 1000 Instruction Set Reference Manual | 1747-6.15 |
| In-depth information on grounding and wiring Allen-Bradley programmable controllers | Allen-Bradley Programmable Controller Grounding and Wiring Guidelines | 1770-4.1 |
| A description on how to install a PLC-5® system | PLC-5 Family Programmable Controllers Hardware Installation Manual | 1785-6.6.1 |
| A description of important differences between solid-state programmable controller products and hard-wired electromechanical devices | Application Considerations for Solid-State Controls | SGL-1.1 |
| An article on wire sizes and types for grounding electrical equipment | National Electrical Code | Published by the National Fire Protection Association of Boston, MA. |
| A complete listing of current Allen-Bradley documentation, including ordering instructions. Also indicates whether the documents are available on CD-ROM or in multi-languages. | Allen-Bradley Publication Index | SD499 |
| A glossary of industrial automation terms and abbreviations | Allen-Bradley Industrial Automation Glossary | AG-7.1 |

Allen-Bradley Drives

Common Techniques Used in this Manual

The following conventions are used throughout this manual:

- Bulleted lists such as this one provide information, not procedural steps.
- Numbered lists provide sequential steps or hierarchical information.
- Text in **this font** indicates words or phrases you should type.
- Key names appear in bold, capital letters within brackets (for example, [**ENTER**]).

Allen-Bradley Support

Allen-Bradley offers support services worldwide, with over 75 Sales/Support Offices, 512 authorized Distributors and 260 authorized Systems Integrators located throughout the United States alone, plus Allen-Bradley representatives in every major country in the world.

Local Product Support

Contact your local Allen-Bradley representative for:

- sales and order support
- product technical training
- warranty support
- support service agreements

Technical Product Assistance

If you need to contact Allen-Bradley for technical assistance, please review the information in the *Troubleshooting* chapter first. Then call your local Allen-Bradley representative.

Your Questions or Comments on this Manual

If you find a problem with this manual, please notify us of it on the enclosed Publication Problem Report.

If you have any suggestions for how this manual could be made more useful to you, please contact us at the address below:

Allen-Bradley Company, Inc.
Automation Group
Technical Communication, Dept. 602V, T122
P.O. Box 2086
Milwaukee, WI 53201-2086

Table of Contents

Preface

| | |
|---|-----|
| Who Should Use this Manual | P-1 |
| Purpose of this Manual | P-1 |
| Contents of this Manual | P-2 |
| Related Documentation | P-2 |
| Common Techniques Used in this Manual | P-4 |
| Allen-Bradley Support | P-4 |
| Local Product Support | P-4 |
| Technical Product Assistance | P-4 |
| Your Questions or Comments on this Manual | P-4 |

Overview

Chapter 1

| | |
|---|-----|
| General Description | 1-1 |
| Hardware Features | 1-2 |
| General Diagnostic Features | 1-3 |
| System Overview | 1-3 |
| System Operation | 1-4 |
| Module Operation | 1-5 |
| Thermocouple Compatibility | 1-5 |
| Linear Millivolt Device Compatibility | 1-7 |

Quick Start for Experienced Users

Chapter 2

| | |
|--|-----|
| Required Tools and Equipment | 2-1 |
| Procedures | 2-2 |

Installation and Wiring

Chapter 3

| | |
|---|------|
| Electrostatic Damage | 3-1 |
| NT4 Power Requirements | 3-1 |
| Module Location in Chassis | 3-2 |
| Modular Chassis Considerations | 3-2 |
| Fixed Expansion Chassis Considerations | 3-2 |
| General Considerations | 3-3 |
| Compliance to European Union Directives | 3-3 |
| EMC Directive | 3-3 |
| Module Installation and Removal | 3-4 |
| Terminal Block Removal | 3-4 |
| Module Installation Procedure | 3-5 |
| Module Removal Procedure | 3-5 |
| Terminal Wiring | 3-6 |
| Wiring Considerations | 3-7 |
| Wiring Input Devices to the NT4 | 3-8 |
| Cold Junction Compensation (CJC) | 3-9 |
| Calibration | 3-10 |

Allen-Bradley Drives

Preliminary Operating Considerations

Chapter 4

| | |
|--|-----|
| Module ID Code | 4-1 |
| Module Addressing | 4-2 |
| Output Image - Configuration Words | 4-2 |
| Input Image - Data Words and Status Words | 4-3 |
| Channel Filter Frequency Selection | 4-4 |
| Effective Resolution | 4-4 |
| Channel Cut-Off Frequency | 4-5 |
| Channel Step Response | 4-6 |
| Update Time | 4-7 |
| Update Time Calculation Example | 4-8 |
| Channel Turn-On, Turn-Off, and Reconfiguration Times | 4-8 |
| Response to Slot Disabling | 4-9 |
| Input Response | 4-9 |
| Output Response | 4-9 |

Channel Configuration, Data, and Status

Chapter 5

| | |
|---|------|
| Channel Configuration | 5-1 |
| Channel Configuration Procedure | 5-2 |
| Select Input Type (Bits 0-3) | 5-4 |
| Select Data Format (Bits 4 and 5) | 5-4 |
| Using Scaled-for-PID and Proportional Counts | 5-5 |
| Scaling Examples | 5-6 |
| Scaled-for-PID to Engineering Units | 5-6 |
| Engineering Units to Scaled-for-PID | 5-6 |
| Proportional Counts to Engineering Units | 5-6 |
| Engineering Units to Proportional Counts | 5-6 |
| Select Open Circuit State (Bits 6 and 7) | 5-8 |
| Select Temperature Units (Bit 8) | 5-9 |
| Select Channel Filter Frequency (Bits 9 and 10) | 5-9 |
| Select Channel Enable (Bit 11) | 5-10 |
| Unused Bits (Bits 12-15) | 5-10 |
| Channel Data Word | 5-10 |
| Channel Status Checking | 5-11 |
| Input Type Status (Bits 0-3) | 5-13 |
| Data Format Type Status (Bits 4 and 5) | 5-13 |
| Open Circuit Type Status (Bits 6 and 7) | 5-13 |
| Temperature Units Type Status (Bit 8) | 5-13 |
| Channel Filter Frequency (Bits 9 and 10) | 5-13 |
| Channel Status (Bit 11) | 5-13 |
| Open-Circuit Error (Bit 12) | 5-14 |
| Under-Range Error (Bit 13) | 5-14 |
| Over-Range Error (Bit 14) | 5-14 |
| Configuration Error (Bit 15) | 5-14 |

Ladder Programming Examples

Chapter 6

| | |
|---|-----|
| Initial Programming | 6-1 |
| Procedure | 6-2 |
| Dynamic Programming | 6-3 |
| Verifying Channel Configuration Changes | 6-4 |
| Interfacing to the PID Instruction | 6-5 |
| Monitoring Channel Status Bits | 6-6 |
| Invoking Autocalibration | 6-7 |

Module Diagnostics and Troubleshooting

Chapter 7

| | |
|--|-----|
| Module Operation vs. Channel Operation | 7-1 |
| Power-Up Diagnostics | 7-1 |
| Channel Diagnostics | 7-2 |
| LED Indicators | 7-3 |
| Channel Status LEDs (Green) | 7-4 |
| Invalid Channel Configuration | 7-4 |
| Open Circuit Detection | 7-4 |
| Out-Of-Range Detection | 7-5 |
| Module Status LED (Green) | 7-5 |
| Troubleshooting Flowchart | 7-6 |
| Replacement Parts | 7-7 |
| Contacting Allen-Bradley | 7-7 |

Application Examples

Chapter 8

| | |
|--|------|
| Basic Example | 8-1 |
| Application Setup (Display a Temperature) | 8-1 |
| Device Configuration | 8-1 |
| Channel Configuration | 8-2 |
| Channel Configuration Worksheet (With Settings Established for Channel 0) | 8-2 |
| Program Listing | 8-3 |
| Data Table | 8-3 |
| Supplementary Example | 8-4 |
| Application Setup (Four Channel °C ↔ °F) | 8-4 |
| Device Configuration | 8-4 |
| Channel Configuration | 8-5 |
| Channel Configuration Worksheet (With Settings Established) .. | 8-6 |
| Program Setup and Operation Summary | 8-7 |
| Program Listing | 8-7 |
| Data Table | 8-10 |

Allen-Bradley Drives

Specifications**Appendix A**

| | |
|--|-----|
| Electrical Specifications | A-1 |
| Physical Specifications | A-1 |
| Environmental Specifications | A-2 |
| Input Specifications | A-2 |
| Input Resolution per Thermocouple Type at Each Filter Frequency | A-4 |

**NT4 Configuration
Worksheet****Appendix B**

| | |
|---|-----|
| Channel Configuration Procedure | B-1 |
| Channel Configuration Summary Worksheet | B-3 |

Thermocouple Restrictions**Appendix C**

| | |
|----------------------------------|-----|
| J Type Thermocouple | C-1 |
| K Type Thermocouple | C-2 |
| T Type Thermocouple | C-3 |
| E Type Thermocouple | C-4 |
| S and R Type Thermocouples | C-5 |

Thermocouple Types**Appendix D****Glossary****Index**

Overview

This chapter describes the thermocouple/millivolt module and explains how the SLC controller gathers thermocouple or millivolt-initiated analog input from the module. Included is information about:

- the module's hardware and software features
- an overview of system operation
- compatibility

General Description

The thermocouple/mV module receives and stores digitally converted thermocouple and/or millivolt (mV) analog data into its image table for retrieval by all fixed and modular SLC 500 processors. The module supports connections from any combination of up to four thermocouple or mV analog sensors.

The following tables define thermocouple types and their associated full scale temperature ranges and also list the millivolt analog input signal ranges that each 1746-NT4 channel will support. To determine the practical temperature range your thermocouple supports, refer to the specifications in Appendix A.

NT4 Module Thermocouple Temperature Ranges

| Type | °C Temperature Range | °F Temperature Range |
|------------|----------------------|----------------------|
| J | -210°C to 760°C | -346°F to 1400°F |
| K | -270°C to 1370°C | -454°F to 2498°F |
| T | -270°C to 400°C | -454°F to 752°F |
| B | 300°C to 1820°C | 572°F to 3308°F |
| E | -270°C to 1000°C | -454°F to 1832°F |
| R | 0°C to 1768°C | 32°F to 3214°F |
| S | 0°C to 1768°C | 32°F to 3214°F |
| N | 0°C to 1300°C | 32°F to 2372°F |
| CJC Sensor | 0°C to 85°C | 32°F to 185°F |

NT4 Module Millivolt Input Ranges

| Millivolt Input Type | Range |
|----------------------|--------------------------|
| ±50 mV | -50 mV dc to +50 mV dc |
| ±100 mV | -100 mV dc to +100 mV dc |

Each input channel is individually configurable for a specific input device and provides open-circuit, over-range, and under-range detection and indication.

Hardware Features

| Hardware | Function |
|-------------------------------|---|
| Channel Status LED Indicators | Display operating and fault status of channels 0, 1, 2, and 3 |
| Module Status LED | Displays module operating and fault status |
| Side Label (Nameplate) | Provides module information |
| Removable Terminal Block | Provides physical connection to input devices. It is color coded green. |
| Door Label | Permits easy terminal identification |
| Cable Tie Slots | Secure and route wiring from module |
| Self-Locking Tabs | Secure module in chassis slot |

General Diagnostic Features

The thermocouple/mV module contains diagnostic features that can help you identify the source of problems that may occur during power-up or during normal channel operation. These power-up and channel diagnostics are explained in chapter 7, *Module Diagnostics and Troubleshooting*.

System Overview

The thermocouple module communicates to the SLC 500 processor through the parallel backplane interface and receives +5V dc and +24V dc power from the SLC 500 power supply through the backplane. No external power supply is required. You may install as many thermocouple modules in your system as the power supply can support.

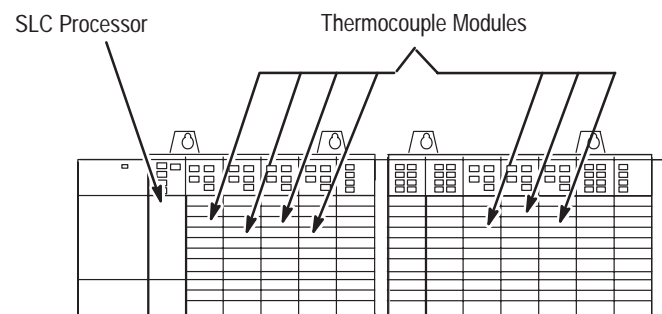

Each individual channel on the thermocouple module can receive input signals from thermocouple sensors or mV analog input devices. You configure each channel to accept either input. When configured for thermocouple input types, the thermocouple module converts the analog input voltages into cold-junction compensated and linearized, digital temperature readings. The 1746-NT4 uses the National Bureau of Standards (NBS) Monograph 125 and 161 based on IPTS-68 for thermocouple linearization.

Allen-Bradley Drives

When configured for millivolt analog inputs, the module converts the analog values directly into digital values. The module assumes that the mV input signal is already linear.

System Operation

At power-up, the thermocouple module performs a check of its internal circuits, memory, and basic functions. During this time the module status LED remains off. If no faults are found during the power-up diagnostics, the module status LED is turned on.

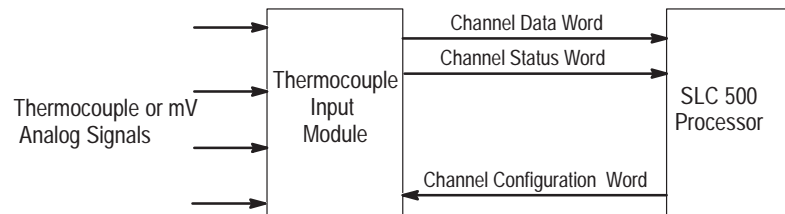

After power-up checks are complete, the thermocouple module waits for valid channel configuration data from your SLC ladder logic program (channel status LEDs off). After configuration data is written to one or more channel configuration words and their channel enable status bits are set, the channel status LEDs go on and the thermocouple module continuously converts the thermocouple or millivolt input to a value within the range you selected for the enabled channels.

Each time a channel is read by the module, that data value is tested by the module for a fault condition, i.e. open circuit, over range, and under range. If such a condition is detected, a unique bit is set in the channel status word and the channel status LED blinks.

The SLC processor reads the converted thermocouple or millivolt data from the module at the end of the program scan, or when commanded by the ladder program. The processor and thermocouple module determine that the backplane data transfer was made without error, and the data is used in your ladder program.

Module Operation

The thermocouple module input circuitry consists of four differential analog inputs multiplexed into a single analog-to-digital (A/D) convertor. The mux circuitry also continuously samples the CJC A and CJC B sensors and compensates for temperature changes at the cold junction (terminal block). The figure on the following page shows a block diagram for the analog input circuitry.

The A/D convertor reads the selected input signal and converts it to a digital value. The multiplexer sequentially switches each input channel to the module's A/D convertor. Multiplexing provides an economical means for a single A/D convertor to convert multiple analog signals. However, it does affect the speed at which an input signal can change and still be detected by the convertor.

Thermocouple Compatibility

The thermocouple module is fully compatible with all SLC 500 fixed and modular controllers. It is compatible with all NBS MN-125 standard types J, K, T, E, R, S, and B thermocouple sensors and extension wire; and with NBS MN-161, 14AWG, standard type N thermocouple and extension wire. Refer to Appendix C for more details.

The Series B (or higher) 1746-NT4 differential design allows for a maximum channel-to-channel common-mode voltage difference/separation of 2 volts. This means that if you are using an NT4 with multiple grounded thermocouples with metallic sheaths or exposed thermocouples with measuring junctions that make contact with electrically conductive material, their ground potentials must be within 2 volts. If this is not done, your temperature readings will be inaccurate or the module could be damaged. If your grounded thermocouple protective sheath is made of an electrically non-conductive material such as ceramic, then the voltage separation specification is not as important. Refer to Appendix D for an explanation of grounded, ungrounded, and exposed thermocouples.

Use the analog common (**ANALOG COM**) terminal for applications that have multiple grounded thermocouples. This analog common terminal must be jumpered to either the (+) or (-) terminal of any active channel which is connected to a grounded thermocouple. See Wiring Considerations on page 3-7 for complete information on the use of the **ANALOG COM** terminal.

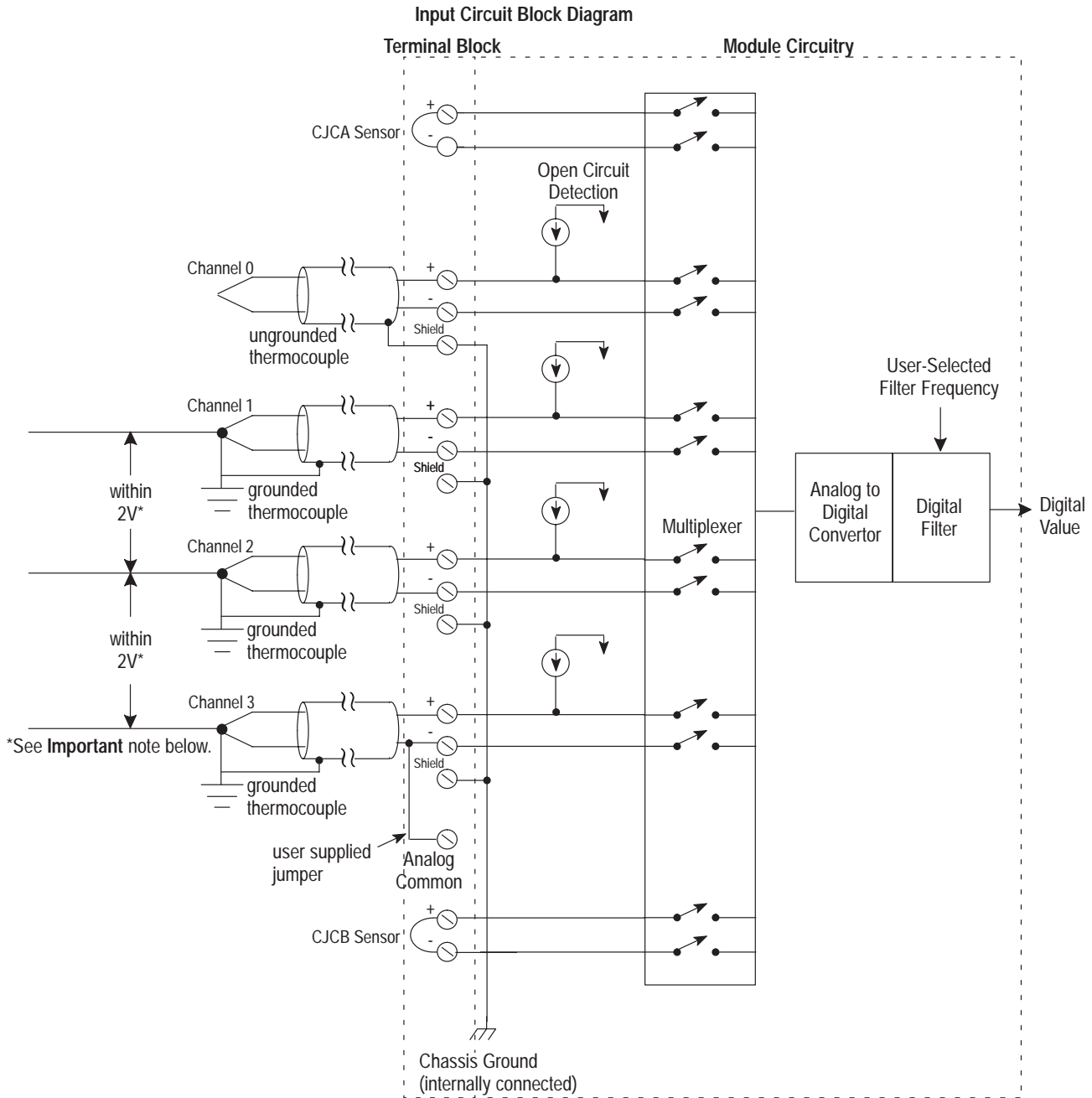

Important: When using multiple grounded and/or exposed thermocouples that are touching on electrically conductive material with the Series B or higher 1746-NT4, the ground potential *between any two* channels cannot exceed 2 volts.



ATTENTION: The possibility exists that grounded or exposed thermocouples can become shorted to a potential greater than that of the thermocouple itself. Due to possible shock hazard, care should be taken when wiring these types of thermocouples. Refer to Appendix D for more details.

Linear Millivolt Device Compatibility

A large number of millivolt devices may be used with the 1746-NT4 module. For this reason we do not specify compatibility with any particular device.

However, millivolt applications often use bridges of strain gages. To allow the NT4 Series B (or higher) to operate correctly, the analog common (**ANALOG COM**) terminal of the module needs to be biased to a level within 2V of the signal of interest. A resistive voltage divider using 10k Ω resistors is recommended to accomplish this. The circuit diagram below shows how this connection is made.

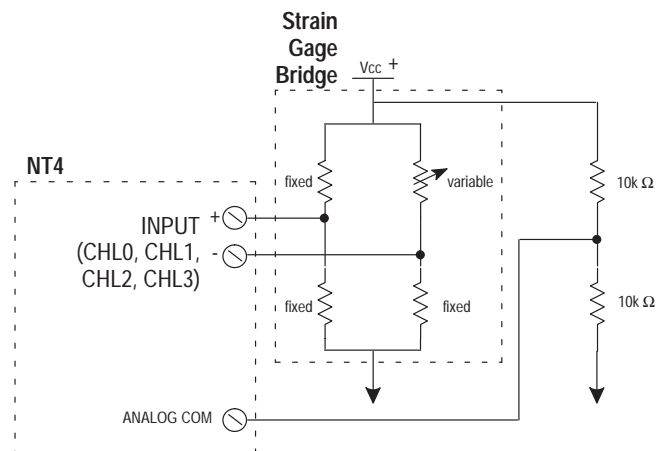

Quick Start for Experienced Users

This chapter can help you to get started using the NT4 thermocouple/mV module. We base the procedures here on the assumption that you have an understanding of SLC 500 products. You should understand electronic process control and be able to interpret the ladder logic instructions required to generate the electronic signals that control your application.

Because it is a start-up guide for experienced users, this chapter *does not* contain detailed explanations about the procedures listed. It does, however, reference other chapters in this book where you can get more information about applying the procedures described in each step. It also references other documentation that may be helpful if you are unfamiliar with programming techniques or system installation requirements.

If you have any questions or are unfamiliar with the terms used or concepts presented in the procedural steps, *always read the referenced chapters* and other recommended documentation before trying to apply the information.

This chapter will:

- tell you what equipment you need
- explain how to install and wire the module
- show you how to set up one channel for thermocouple input
- examine the state of the LEDs at normal startup
- examine the channel status word

Required Tools and Equipment

Have the following tools and equipment ready:

- medium blade screwdriver
- medium cross-head screwdriver
- thermocouple or millivolt sensor
- appropriate thermocouple extension wire (if needed)
- thermocouple/mV input module (1746-NT4)
- programming equipment

Procedures

| | | |
|-----------|--|-----------|
| 1. | Check the contents of shipping box. | Reference |
|-----------|--|-----------|

Unpack the shipping box making sure that the contents include:

- thermocouple input module (Catalog Number 1746-NT4)
- removable terminal block (factory-installed on module) with CJC sensors attached
- user manual (Publication 1746-6.6)

If the contents are incomplete, call your local Allen-Bradley representative for assistance.

| | | |
|-----------|---|-----------|
| 2. | Ensure your chassis supports placement of the 1746-NT4 module. | Reference |
|-----------|---|-----------|

Review the power requirements of your system to see that your chassis supports placement of the thermocouple input module:

- The fixed, 2-slot chassis supports 2 thermocouple input modules. If combining a thermocouple module with a different module, refer to the module compatibility table found in chapter 3.
- For modular style systems, calculate the total load on the system power supply using the procedure described in the SLC Installation & Operation Manual for modular style controllers (publication number 1747-6.2) or the SLC 500 Family System Overview (publication number 1747-2.30).

Chapter 3
(Installation and Wiring)

Appendix B
(Specifications)

| | | |
|-----------|---|-----------|
| 3. | Insert the 1746-NT4 module into the chassis. | Reference |
|-----------|---|-----------|



ATTENTION: Never install, remove, or wire modules with power applied to the chassis or devices wired to the module.

Make sure system power is off; then insert the thermocouple input module into your 1746 chassis. In this example procedure, local slot 1 is selected.

Chapter 3
(Installation and Wiring)

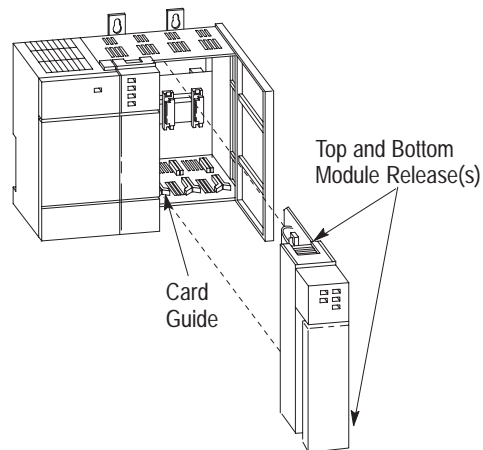

4. Connect thermocouple wires.

Reference

Connect thermocouple wires to channel 0 on the module's terminal block. Make sure both cold junction compensation (CJC) assemblies are securely attached.

Important:

Ground the shield drain wire at one end only. The preferred location is to the same point as the sensor ground reference.

- 1) For grounded thermocouples or mV sensors, this is at the sensor.
- 2) For insulated/ungrounded thermocouples, this is at the NT4 module.

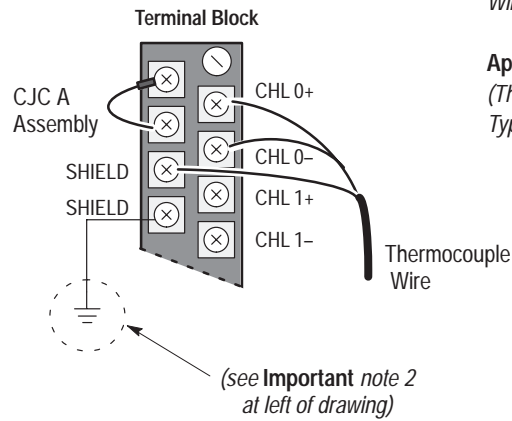

Chapter 3
(Installation and Wiring)

Appendix D
(Thermocouple Types)

5. Configure the system.

Reference

Configure your system I/O configuration for the particular slot the NT4 is in (slot 1 in this example). Enter the thermocouple input module ID code (3510).

No manual entry of special I/O configuration information is required, as the module ID code automatically assigns the number of input and output words required by the module.

Chapter 4
(Preliminary Operating Considerations)

Your programming device's user manual.

| | | |
|-----------|--|-----------|
| 6. | Determine the operating parameters. | Reference |
|-----------|--|-----------|

Determine the operating parameters for channel 0. This example shows the channel 0 configuration word defined with all defaults (0) except for channel enable (bit 11). The addressing reflects the location of the module as slot 1.

Chapter 4
(Preliminary Operating Considerations)

Chapter 5
(Channel Configuration, Data, and Status)

Appendix B
(NT4 Configuration Worksheet)

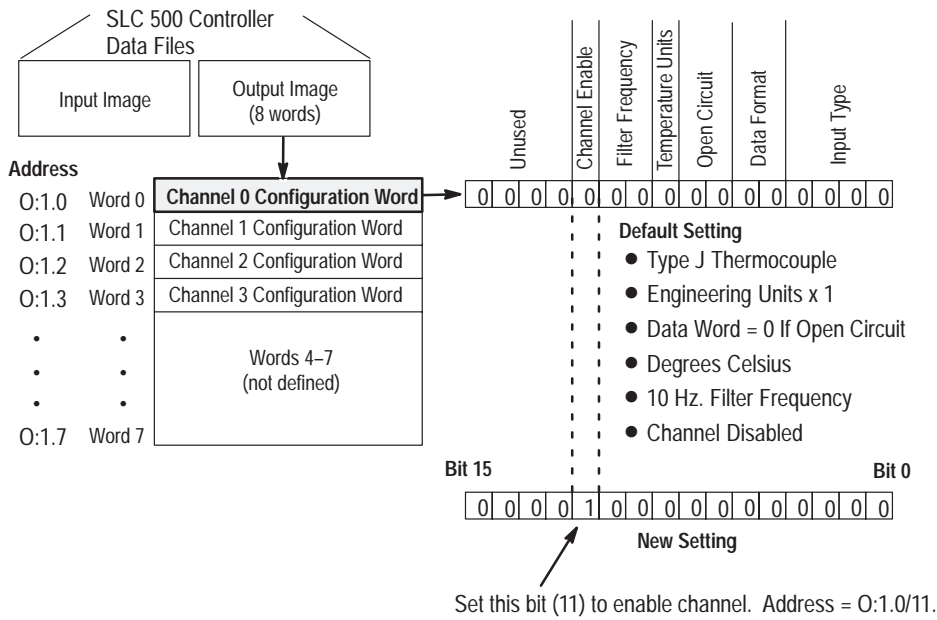

| | |
|--------------------------------------|------------------|
| 7. Program the configuration. | Reference |
|--------------------------------------|------------------|

Do the programming necessary to establish the new configuration word setting in the previous step.

1. Create integer file N10. Integer file N10 should contain one element for each channel used.
(For this example we only need one, N10:0.)
2. Enter the configuration parameters from step 6 for channel 0 into integer N10:0.
In this example all the bits of N10:0 will be zero except for the channel enable (N10:0/11).
3. Program an instruction in your ladder logic to copy the contents of N10:0 to output word O:1.0.

Chapter 6
(Ladder Programming Examples)

Chapter 8
(Application Examples)

Example of Data Table for Integer File N10:

| address | 15 | data | 0 | address | 15 | data | 0 |
|---------|------|------|------|---------|------|------|------|
| N10:0 | 0000 | 1000 | 0000 | 0000 | 0000 | 0000 | 0000 |

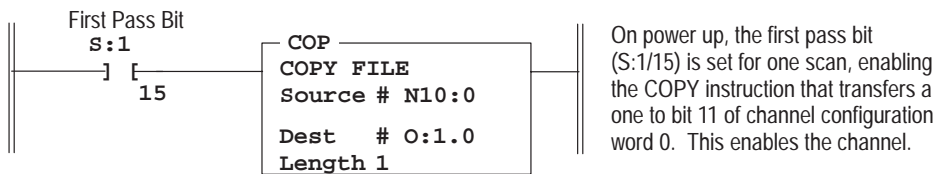

| | |
|---------------------------------|------------------|
| 8. Write ladder program. | Reference |
|---------------------------------|------------------|

Write the remainder of the ladder logic program that specifies how your thermocouple input data will be processed for your application. In this procedure the addressing reflects the location of the module as slot 1.

Chapter 5
(Channel Configuration, Data, and Status)

Chapter 6
(Ladder Programming Examples)

Chapter 8
(Application Examples)

Your programming device's user manual.

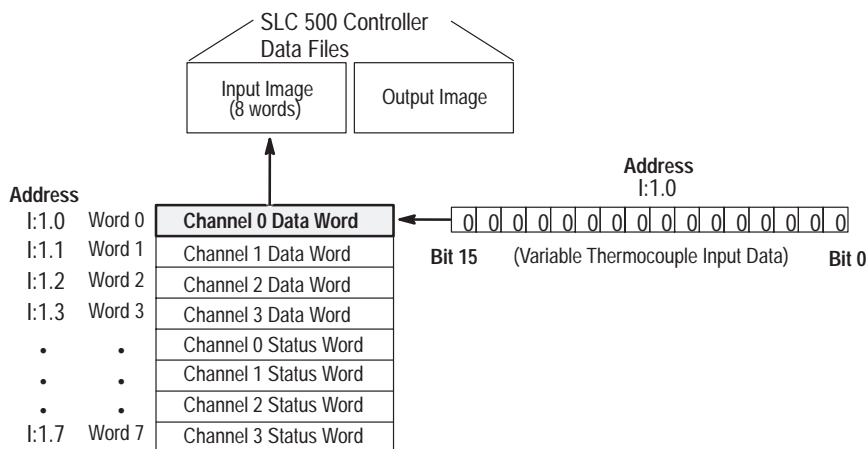

| | | |
|-----------|--|-----------|
| 9. | Go through the system start-up procedure. | Reference |
|-----------|--|-----------|

Apply power. Download your program to the SLC and put the controller into Run mode. In this example during a normal start up, the module status LED and channel status 0 LED turn on.

Chapter 7
(Module Diagnostics and Troubleshooting)

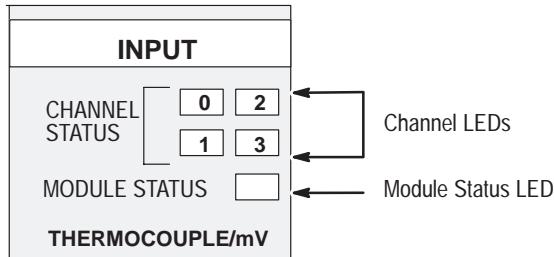

| | | |
|------------|--|-----------|
| 10. | Check that the module is operating correctly. | Reference |
|------------|--|-----------|

(Optional) Monitor the status of input channel 0 to determine its configuration setting and operational status. This is useful for troubleshooting when the blinking channel LED indicates that an error has occurred. If the Module Status LED is off, or if the Channel 0 LED is off or blinking, refer to chapter 7.

Chapter 5
(Channel Configuration, Data, and Status)

Chapter 7
(Module Diagnostics and Troubleshooting)

Chapter 8
(Application Examples)

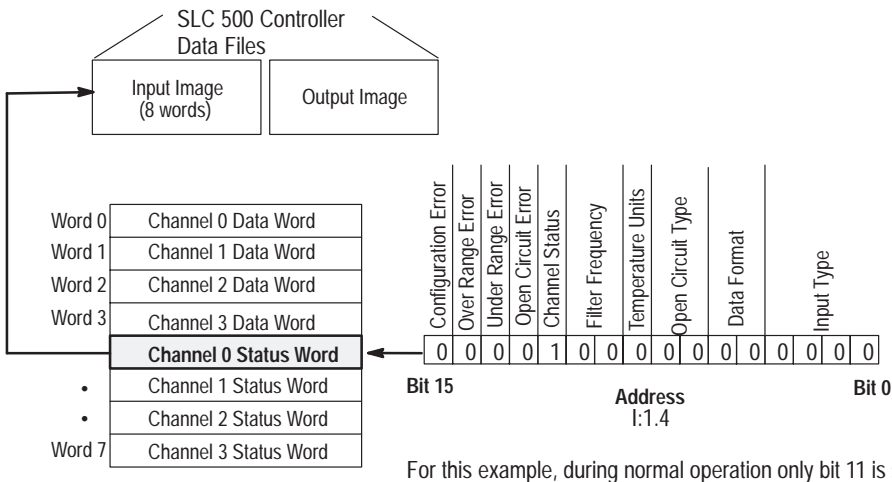

Installation and Wiring

This chapter tells you how to:

- avoid electrostatic damage
- determine the thermocouple module's chassis power requirement
- choose a location for the thermocouple module in the SLC chassis
- install the thermocouple module
- wire the thermocouple module's terminal block

Electrostatic Damage

Electrostatic discharge can damage semiconductor devices inside this module if you touch backplane connector pins. Guard against electrostatic damage by observing the precautions listed next.



ATTENTION: Electrostatic discharge can degrade performance or cause permanent damage. Handle the module as stated below.

- Wear an approved wrist strap grounding device when handling the module.
- Touch a grounded object to rid yourself of electrostatic charge before handling the module.
- Handle the module from the front, away from the backplane connector. do not touch backplane connector pins.
- Keep the module in its static-shield bag when not in use, or during shipment.

NT4 Power Requirements

The thermocouple module receives its power through the SLC500 chassis backplane from the fixed or modular +5 VDC/+24 VDC chassis power supply. The maximum current drawn by the module is shown in the table below.

| 5VDC Amps | 24VDC Amps |
|-----------|------------|
| 0.060 | 0.040 |

When you are using a *modular system* configuration, add the values shown in the table above to the requirements of all other modules in the SLC chassis to prevent overloading the chassis power supply.

When you are using a *fixed system* controller, refer to the important note about module compatibility in a 2-slot expansion chassis on page 3-2.

Module Location in Chassis

Fixed Controller Compatibility Table

| | NT4 | 5VDC AMPS | 24VDC AMPS |
|-----------------------|-----|--------------|---------------|
| IA4 | • | 0.035 | - |
| IA8 | • | 0.050 | - |
| IA16 | • | 0.085 | - |
| IM4 | • | 0.035 | - |
| IM8 | • | 0.050 | - |
| IM16 | • | 0.085 | - |
| OA8 | • | 0.185 | - |
| OA16 | • | 0.370 | - |
| OAP12 | • | 0.370 | - |
| IB8 | • | 0.050 | - |
| IB16 | • | 0.085 | - |
| IV8 | • | 0.050 | - |
| IV16 | • | 0.085 | - |
| IG16 | • | 0.140 | - |
| OV8 | • | 0.135 | - |
| OV16 | • | 0.270 | - |
| OB8 | • | 0.135 | - |
| OBP8 | • | 0.135 | - |
| OG16 | • | 0.180 | - |
| OW4 | • | 0.045 | 0.045 |
| OW8 | • | 0.085 | 0.090 |
| OW16 | | 0.170 | 0.180 |
| IO4 | • | 0.030 | 0.025 |
| IO8 | • | 0.060 | 0.045 |
| IO12 | • | 0.090 | 0.070 |
| NI4 | • | 0.025 | 0.085 |
| NIO4I | • | 0.055 | 0.145 |
| NIO4V | • | 0.055 | 0.115 |
| FIO4I | • | 0.055 | 0.150 |
| FIO4V | • | 0.055 | 0.120 |
| DCM | • | 0.360 | - |
| HS | • | 0.300 | - |
| OB16 | • | 0.280 | - |
| IN16 | • | 0.085 | - |
| BASn | • | 0.150 | 0.125 |
| BAS | • | 0.150 | 0.040 |
| OB32 | | 0.452 | - |
| OV32 | | 0.452 | - |
| IV32 | • | 0.106 | - |
| IB32 | • | 0.106 | - |
| OX8 | • | 0.085 | 0.090 |
| NO4I | ▽ | 0.055 | 0.195 |
| NO4V | • | 0.055 | 0.145 |
| ITB16 | • | 0.085 | - |
| ITV16 | • | 0.085 | - |
| IC16 | • | 0.085 | - |
| KE | • | 0.150 | 0.040 |
| KE_n | • | 0.150 | 0.145 |
| OBP16 | • | 0.250 | - |
| OVP16 | • | 0.250 | - |
| NT4 | • | 0.060 | 0.040 |
| NR4 | • | 0.050 | 0.050 |
| HSTP1 | • | 0.200 | - |

Modular Chassis Considerations

Place your thermocouple module in any slot of an SLC 500 modular, or modular expansion chassis, except for the extreme left slot (slot 0) in the first chassis. This slot is reserved for the processor or adapter modules.

Fixed Expansion Chassis Considerations

Important: The 2-slot, SLC 500 fixed I/O expansion chassis (1746-A2) will support only specific combinations of modules. If you are using the thermocouple module in a 2-slot expansion chassis with another SLC I/O or communication module, refer to the table at the left to determine whether the combination can be supported. In the table:

- A dot indicates a valid combination.
- No symbol indicates an invalid combination.
- A triangle indicates an external power supply is required. (Refer to the Analog I/O Module User Manual, 1746-6.4.)

When using the table, be aware that there are certain conditions that affect the compatibility characteristics of the BASIC module (**BAS**) and the DH-485/RS-232C module (**KE**).

When you use the BAS module or the KE module to supply power to a 1747-AIC Link Coupler, the Link Coupler draws its power through the module. The higher current drawn by the AIC at 24 VDC is calculated and recorded in the table for the modules identified as **BAS_n** (BAS networked) or **KE_n** (KE networked). Make sure to refer to these modules if your application uses the BAS or KE module in this way.

General Considerations

Most applications require installation in an industrial enclosure to reduce the effects of electrical interference. Thermocouple inputs are highly susceptible to electrical noises due to the small amplitudes of their signal (microvolt/°C).

Group your modules to minimize adverse effects from radiated electrical noise and heat. Consider the following conditions when selecting a slot for the thermocouple module. Position the module:

- in a slot away from sources of electrical noise such as hard-contact switches, relays, and AC motor drives
- away from modules which generate significant radiated heat, such as the 32-point I/O modules

In addition, route shielded twisted pair thermocouple or millivolt input wiring away from any high voltage I/O wiring.

Compliance to European Union Directives

If this product has the CE mark it is approved for installation within the European Union and EEA regions. It has been designed and tested to meet the following directives.

EMC Directive

The Series B (or higher) 1746-NT4 is tested to meet Council Directive 89/336/EEC Electromagnetic Compatibility (EMC) and the following standards, in whole or in part, documented in a technical construction file:

- EN 50081-2
EMC - Generic Emission Standard, Part 2 - Industrial Environment
- EN 50082-2
EMC - Generic Immunity Standard, Part 2 - Industrial Environment

This product is intended for use in an industrial environment.

Allen-Bradley Drives

Module Installation and Removal

When installing the module in a chassis, it is not necessary to remove the terminal block from the module. However, if the terminal block is removed, use the write-on label located on the side of the terminal block to identify the module location and type.

| | |
|----------------|-----------|
| SLOT ____ | RACK ____ |
| ● MODULE _____ | |

Terminal Block Removal



ATTENTION: Never install, remove, or wire modules with power applied to the chassis or devices wired to the module.

To remove the terminal block:

1. Loosen the two terminal block release screws.
2. Grasp the terminal block at the top and bottom and pull outward and down. When removing or installing the terminal block be careful not to damage the CJC sensors.

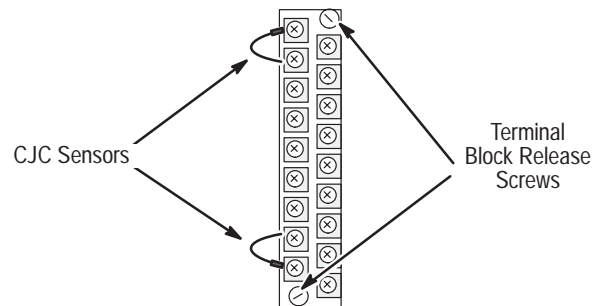

Module Installation Procedure

1. Align the circuit board of the thermocouple module with the card guides located at the top and bottom of the chassis.
2. Slide the module into the chassis until both top and bottom retaining clips are secured. Apply firm even pressure on the module to attach it to its backplane connector. Never force the module into the slot.
3. Cover all unused slots with the Card Slot Filler, Catalog Number 1746-N2.

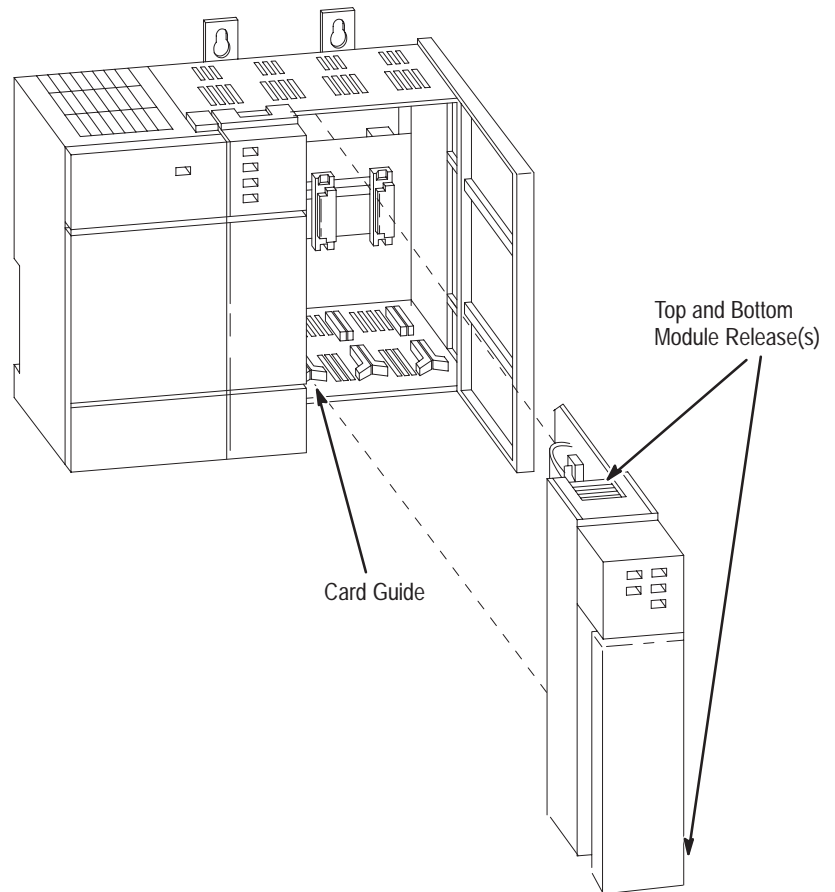

Module Removal Procedure

1. Press the releases at the top and bottom of the module and slide the module out of the chassis slot.
2. Cover all unused slots with the Card Slot Filler, Catalog Number 1746-N2.

Allen-Bradley Drives

Terminal Wiring

The thermocouple module contains a green, 18-position, removable terminal block. The terminal pin-out is shown below.



ATTENTION: Disconnect power to the SLC before attempting to install, remove, or wire the removable terminal wiring block.

To avoid cracking the removable terminal block, alternate the removal of the slotted terminal block release screws.

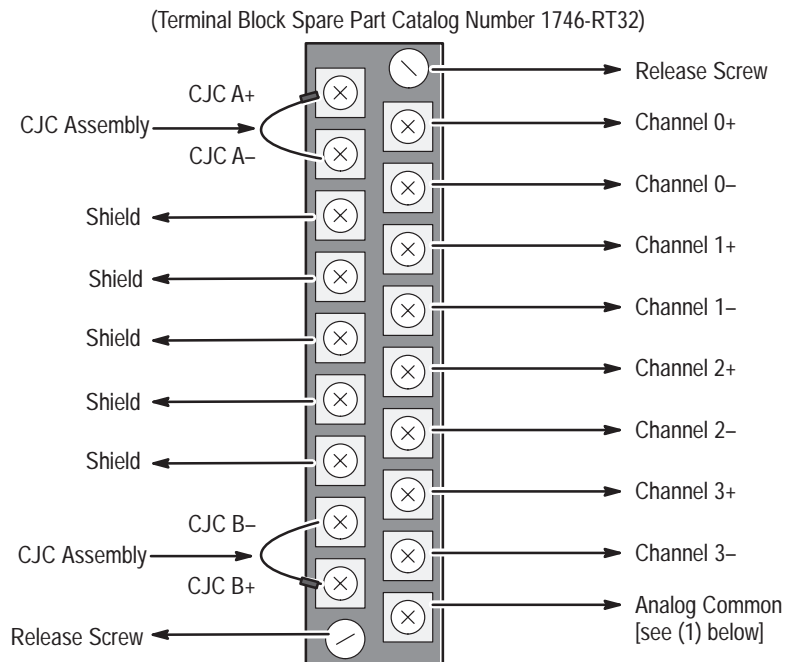

- (1) Replacing a Series A thermocouple module with a Series B module requires that the bottom right terminal (which was SHIELD on Series A modules) no longer be connected to CHASSIS GROUND if it was previously. Use one of the other SHIELD terminals.

Wiring Considerations



ATTENTION: The possibility exists that grounded or exposed thermocouples can become shorted to a potential greater than that of the thermocouple itself. Due to possible shock hazard, care should be taken when wiring these types of thermocouples. Refer to Appendix D for more details.

Follow the guidelines below when planning your system wiring.

- To limit noise, keep thermocouple and millivolt signal wires as far away as possible from power and load lines.
- To ensure proper operation and high immunity to electrical noise, always use Belden 8761 (shielded, twisted pair) or equivalent wire for millivolt sensors or shielded, twisted pair thermocouple extension lead wire specified by the thermocouple manufacturer for the thermocouple type you are using. Using the incorrect thermocouple extension wire type or not following the correct polarity convention will cause invalid readings.
- Special considerations for using the analog common (ANALOG COM) terminal based on thermocouple type: (See Appendix D for definitions of thermocouple types.)
 - When using grounded thermocouple(s), jumper the ANALOG COM terminal to any single active grounded channel's plus (+) or minus (–) terminal.
 - When using exposed thermocouple(s) that have the thermocouple junction touching an electrically conductive material, jumper the ANALOG COM terminal to any single active exposed channel's plus (+) or minus (–) terminal.
 - When using ungrounded (shielded) or exposed thermocouples that are not touching an electrically conductive material, do not use the ANALOG COM terminal.
 - When using a mix of grounded, ungrounded and exposed thermocouples, jumper the ANALOG COM terminal to any single active grounded channel's plus (+) or minus (–) terminal.
 - If millivolt inputs are used, the terminal should be handled as discussed on page 1-7.

NOTE: The Series A 1746-NT4 does not have an ANALOG COM terminal and cannot be used with multiple grounded and/or exposed thermocouples that touch electrically conductive material. The Series A can be used with a single grounded and/or exposed thermocouple that touches electrically conductive material, or multiple grounded thermocouples that have the protective sheath made of an electrically non-conductive material such as ceramic.

- Ground the shield drain wire at one end only. The preferred location is to the same point as the sensor ground reference.
 - For grounded thermocouples or mV sensors, this is at the sensor.
 - For insulated/ungrounded thermocouples, this is at the module.
 (Refer to IEEE Std. 518, Section 6.4.2.7 or contact your sensor manufacturer for additional details.)
- If it is necessary to connect the shield at the module, each input channel has a convenient shield connection screw terminal that provides a connection to chassis ground. All shields are internally connected, so any shield terminal can be used with channels 0-3. For maximum noise reduction, one shield terminal must be connected to earth ground potential, i.e. mounting bolt on 1746 chassis.
- Tighten terminal screws using a flat or cross-head screwdriver. Each screw should be turned tight enough to immobilize the wire's end. Excessive tightening can strip the terminal screw. The torque applied to each screw should not exceed 5 lb-in (0.565 Nm) for each terminal.
- The open thermocouple detection circuit injects approximately 12 nanoamperes into the thermocouple cable. A total lead resistance of 25 ohms (12.5 one-way) will produce 0.3 μV of error. To reduce error, use large gage wire with less resistance for long wire runs.
- Follow system grounding and wiring guidelines found in your SLC 500 Installation and Operation Manual.

Wiring Input Devices to the NT4

After the thermocouple module is properly installed in the chassis, follow the wiring procedure below using the proper thermocouple extension cable, or Belden 8761 for non-thermocouple applications.

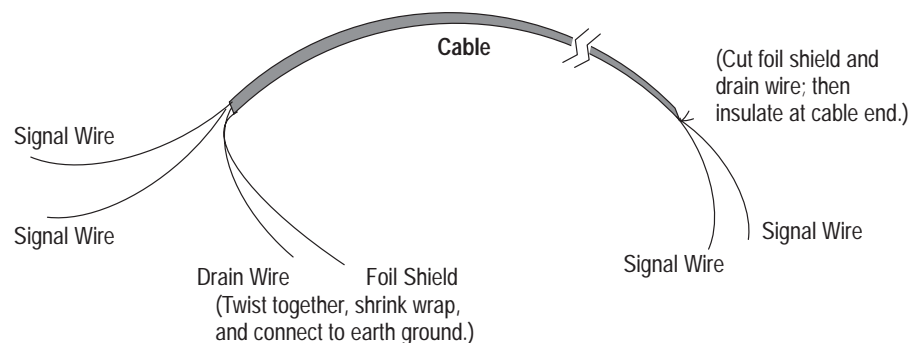

To wire your NT4 module follow these steps.

1. At each end of the cable, strip some casing to expose the individual wires.
2. Trim the signal wires to 2-inch lengths. Strip about 3/16 inch (4.76 mm) of insulation away to expose the end of the wire.
3. At one end of the cable twist the drain wire and foil shield together, bend them away from the cable, and apply shrink wrap. Then earth ground at the preferred location based on the type of sensor you are using (see wiring guidelines on page 3-7.)
4. At the other end of the cable, cut the drain wire and foil shield back to the cable and apply shrink wrap.
5. Connect the signal wires to the NT4 terminal block and the input.
6. Repeat steps 1 through 6 for each channel on the NT4 module.

Cold Junction Compensation (CJC)



ATTENTION: Do not remove or loosen the cold junction compensating thermistor assemblies located between the two upper and lower CJC terminals on the terminal block. *Both thermistor assemblies are critical to ensure accurate thermocouple input readings at each channel.* The module will not operate in the thermocouple mode if either assembly is removed.

To obtain accurate readings from each of the channels, the cold junction temperature (temperature at the module's terminal junction between the thermocouple wire and the input channel) must be compensated for. Two cold junction compensating thermistors have been integrated in the removable terminal block; they *must* remain installed to retain accuracy.

In case of accidental removal of either or both of the thermistor assemblies, make sure to replace them by connecting each one across the CJC terminals located at the top and bottom left side of the terminal block. When connecting the thermistor assembly at the top of the terminal block (between terminals CJC A+ and CJC A-), the lug containing the thermistor (marked with red epoxy) should attach to the uppermost screw terminal (CJC A+). When connecting the thermistor assembly at the bottom of the terminal block (between terminals CJC B+ and CJC B-), the lug containing the thermistor should attach to the lowermost screw terminal (CJC B+).

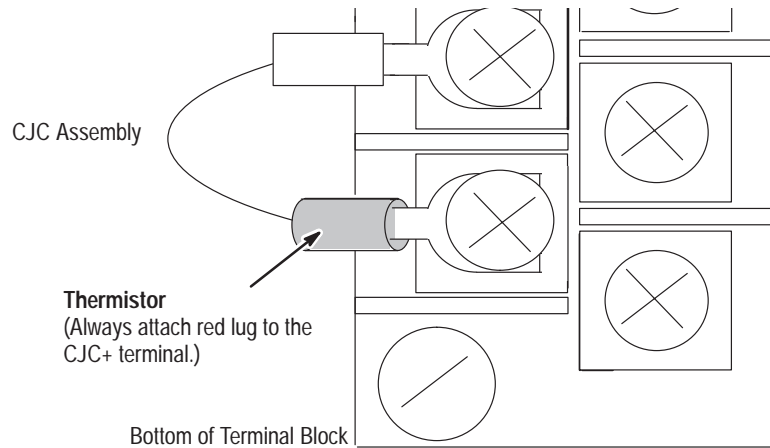

Calibration

The thermocouple module is initially calibrated at the factory. The module also has an autocalibration function. Autocalibration compensates for offset and gain drift of the A/D converter caused by temperature change within the module. An internal, high precision, low drift voltage and system ground reference is used for this purpose. No external, user supplied device is required for autocalibration.

When an autocalibration cycle takes place, the modules multiplexer is set to system ground potential and an A/D reading is taken. The A/D converter then sets its internal input to the modules precision voltage source, and another reading is taken. The A/D converter uses these numbers to compensate for “system” offset (zero) and gain (span) error.

Autocalibration of a channel occurs whenever a channel is enabled, or when a change is made to its input type or filter frequency. You can also command your module to perform an autocalibration cycle by disabling a channel, waiting for the status bit to change state (1 to 0) and then re-enabling that channel. Several channel cycles are required to perform an autocalibration (refer to page 4-8), and it is important to remember that during autocalibration the module is not converting input data.

To maintain system accuracy we recommend that you periodically perform an autocalibration cycle, for example:

- whenever an event occurs that greatly changes the internal temperature of the control cabinet, such as opening or closing its door
- at a convenient time when the system is not making product, such as during a shift change

An autocalibration programming example is provided in chapter 6. Accuracy specifications with and without autocalibration are provided in Appendix A.

Preliminary Operating Considerations

This chapter explains how the thermocouple module and the SLC processor communicate through the module's input and output image. It lists the preliminary setup and operation required before the thermocouple module can function in a 1746 I/O system. Topics discussed include how to:

- enter the module ID code
- address your thermocouple module
- select the proper input filter for each channel
- calculate the thermocouple module update time
- interpret the thermocouple module response to slot disabling

Module ID Code

The module identification code is a unique number encoded for each 1746 I/O module. The code defines for the processor the type of I/O or specialty module residing in a specific slot in the 1746 chassis.

The module ID code for the thermocouple module is shown below:

Module ID Code

| Catalog Number | ID Code |
|----------------|---------|
| 1746-NT4 | 3510 |

No special I/O configuration information is required. The module ID code automatically assigns the correct number of input and output words.

Module Addressing

The following memory map shows you how the output and input image tables are defined for the thermocouple module.

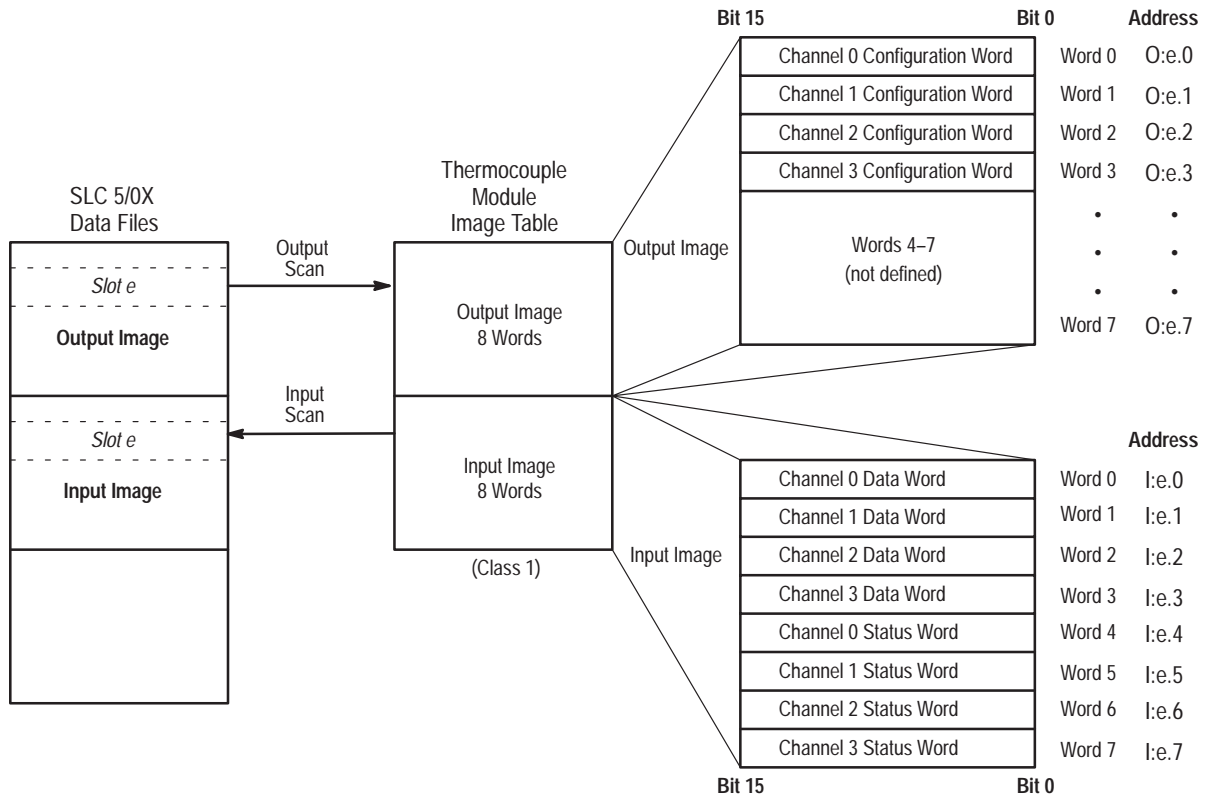

Output Image - Configuration Words

The 8-word, thermocouple module output image (defined as the output from the CPU to the thermocouple module) contains information that you configure to define the way a specific channel on the thermocouple module will work. These words take the place of configuration DIP switches on the module. Although the thermocouple output image is eight words long, only output words 0-3 are used to define the operation of the module; output words 4-7 are not used. Each output word configures a single channel.

Example - If you want to configure channel 2 on the thermocouple module located in slot 4 in the chassis, your address would be O:4.2.

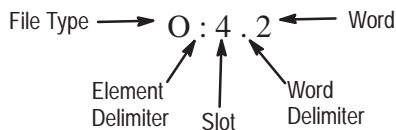

Chapter 5, *Channel Configuration, Data, and Status*, gives you detailed bit information about the data content of the configuration word.

Input Image - Data Words and Status Words

The 8-word, thermocouple module input image (defined as the input from the thermocouple module to the CPU) represents data words and status words.

Input words 0-3 (data words) hold the input data that represent the temperature value of thermocouple analog inputs for channels 0-3. This data word is valid only when the channel is enabled and there are no channel errors.

Input words 4-7 (status words) contain the status of channels 0-3 respectively. The status bits for a particular channel reflect the configuration settings that you have entered into the output image configuration word for that channel and provide information about the channel's operational state. To receive valid status information the channel must be enabled, and the channel must have processed any configuration changes that may have been made to the configuration word.

Example - To obtain the status of channel 2 (input word 6) of the thermocouple module located in slot 4 in the SLC chassis, use address I:4.6.

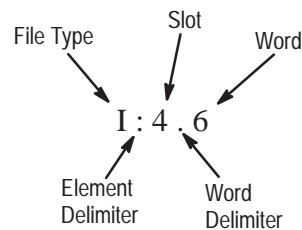

Chapter 5, *Channel Configuration, Data, and Status*, gives you detailed bit information about the content of the data word and the status word.

Channel Filter Frequency Selection

The thermocouple module uses a digital filter that provides high frequency noise rejection for the input signals. The digital filter is programmable, allowing you to select from four filter frequencies for each channel. The digital filter provides the highest noise rejection at the selected filter frequency. The graphs on pages 4-5 and 4-6 show the input channel frequency response for each filter frequency selection.

Selecting a low value (i.e. 10 Hz) for the channel filter frequency provides the best noise rejection for a channel, but it also increases the channel update time. Selecting a high value for the channel filter frequency provides lower noise rejection, but decreases the channel update time.

The following table shows the available filter frequencies, associated minimum normal mode rejection (NMR), cut-off frequency, and step response for each filter frequency.

| Filter Frequency | 50Hz NMR | 60Hz NMR | Cut-Off Frequency | Step Response |
|------------------|----------|----------|-------------------|---------------|
| 10 Hz | 100 dB | 100 dB | 2.62 Hz | 300 msec |
| 50 Hz | 100 dB | - | 13.1 Hz | 60 msec |
| 60 Hz | - | 100 dB | 15.72 Hz | 50 msec |
| 250 Hz | - | - | 65.5 Hz | 12 msec |

Effective Resolution

The effective resolution for an input channel depends upon the filter frequency selected for that channel. Graphs that shows actual bit resolution for the thermocouple types at all filter frequencies are provided in Appendix A.

Channel Cut-Off Frequency

The channel filter frequency selection determines a channel's cut-off frequency, also called the -3 dB frequency. The cut-off frequency is defined as the point on the input channel frequency response curve where frequency components of the input signal are passed with 3 dB of attenuation. All frequency components at or below the cut-off frequency are passed by the digital filter with less than 3 dB of attenuation. All frequency components above the cut-off frequency are increasingly attenuated, as show in the graphs on pages 4-5 and 4-6.

The cut-off frequency for each input channel is defined by its filter frequency selection. The table above shows the input channel cut-off frequency for each filter frequency. Choose a filter frequency so that your fastest changing signal is below that of the filter's cut-off frequency. The cut-off frequency should not be confused with update time. The cut-off frequency relates how the digital filter attenuates frequency components of the input signal. The update time defines the rate at which an input channel is scanned and its channel data word updated.

60 Hz Filter Notch Frequency
Frequency Response

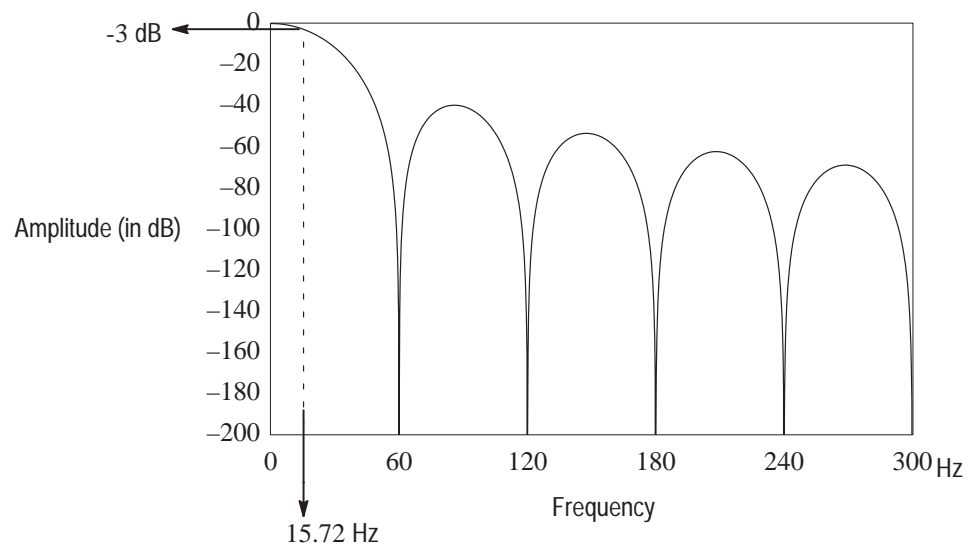

250 Hz Filter Notch Frequency Frequency Response

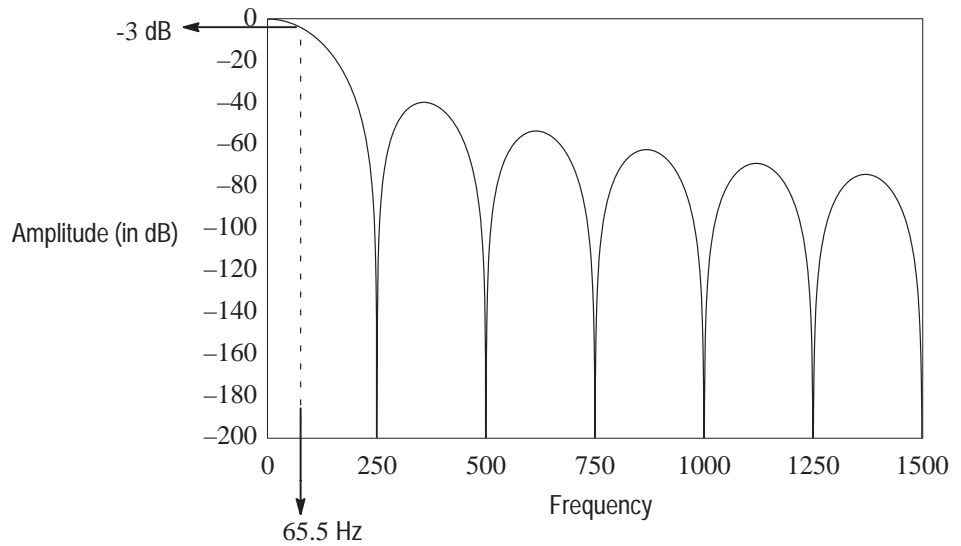

Channel Step Response

The channel filter frequency determines the channel's step response. The step response is time required for the analog input signal to reach 100% of its expected final value. This means that if an input signal changes faster than the channel step response, a portion of that signal will be attenuated by the channel filter. The table on page 4-4 shows the step response for each filter frequency.

Update Time

The thermocouple module update time is defined as the time required for the module to sample and convert the input signals of all enabled input channels and make the resulting data values available to the SLC processor. It can be calculated by adding the the sum of all enabled channel sample times, plus a CJC update time.

The NT4 module sequentially samples the channels in a continuous loop.

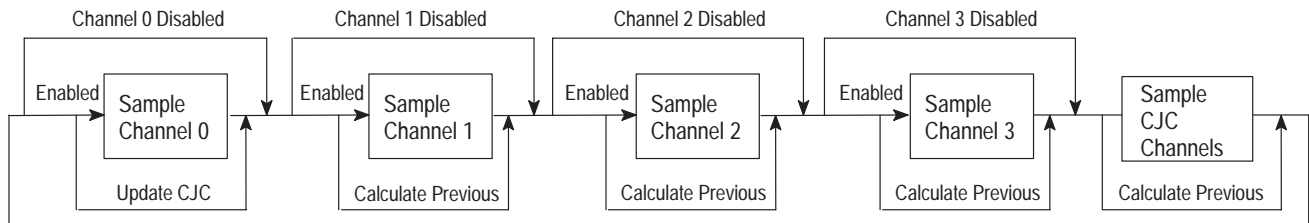

The following table shows the channel sampling times for each filter frequency. It also gives the CJC update time.

Channel Sampling Time for Each Filter Frequency
(all values ±1 msec)

| CJC Update Time | Channel Sampling Time | | | |
|-----------------|-----------------------|--------------|--------------|--------------|
| | 250 Hz Filter | 60 Hz Filter | 50 Hz Filter | 10 Hz Filter |
| 14 msec | 12 msec | 50 msec | 60 msec | 300 msec |

The *fastest module update time* occurs when only one channel with a 250 Hz filter frequency is enabled.

$$\text{Module update time} = 12 \text{ msec} + 14 \text{ msec} = 26 \text{ msec}$$

The *slowest module update time* occurs when four channels, each using a 10 Hz filter frequency, are enabled.

$$\begin{aligned} \text{Module update time} &= 300 \text{ msec} + 300 \text{ msec} + 300 \text{ msec} + 300 \text{ msec} + 14 \text{ msec} \\ &= 1.214 \text{ seconds} \end{aligned}$$

Update Time Calculation Example

The following example shows how to calculate the module update time for the given configuration:

Channel 0 configured for 250 Hz filter frequency, enabled
 Channel 1 configured for 250 Hz filter frequency, enabled
 Channel 2 configured for 50 Hz filter frequency, enabled
 Channel 3 disabled

Using the values from the table above, add the the sum of all enabled channel sample times, plus one CJC update time.

| | |
|---------------------------|------------------|
| Channel 0 sampling time | = 12 msec |
| Channel 1 sampling time | = 12 msec |
| Channel 2 sampling time | = 60 msec |
| CJC update time | = 14 msec |
| Module update time | = 98 msec |

Channel Turn-On, Turn-Off, and Reconfiguration Times

The table below gives you the turn-on, turn-off, and reconfiguration times for enabling or disabling a channel.

| | Description | Duration |
|-----------------------------|--|--|
| Turn-On Time | The time it takes to set the status bit (transition from 0 to 1) in the status word, after setting the enable bit in the configuration word. | Requires up to one module update time plus one of the following: •250 Hz Filter = 82 milliseconds •60 Hz Filter = 196 milliseconds •50 Hz Filter = 226 milliseconds •10 Hz Filter = 946 milliseconds |
| Turn-Off Time | The time it takes to reset the status bit (transition from 1 to 0) in the status word, after resetting the enable bit in the configuration word. | Requires up to one module update time. |
| Reconfiguration Time | The time it takes to change a channel configuration if the device type, filter frequency, or configuration error bits are different from the current setting. The enable bit remains in a steady state of 1. (Changing temperature/mV units or data format does not require reconfiguration time.) | Requires up to one module update time plus one of the following: •250 Hz Filter = 82 milliseconds •60 Hz Filter = 196 milliseconds •50 Hz Filter = 226 milliseconds •10 Hz Filter = 946 milliseconds |

Response to Slot Disabling

By writing to the status file in your modular SLC processor you can disable any chassis slot. Refer to your programming device's manual for the slot disable/enable procedure.



ATTENTION: Always understand the implications of disabling a thermocouple module before using the slot disable feature.

Input Response

When a thermocouple slot is disabled, the thermocouple module continues to update its input image table. However, the SLC processor does not read inputs from a module that is disabled. Therefore, when the processor disables the thermocouple module slot, the module inputs appearing in the processor image table remain in their last state, and the module's updated image table is not read. When the processor re-enables the module slot, the current state of the module inputs are read by the processor during the subsequent scan.

Output Response

The SLC processor may change the thermocouple module output data (configuration) as it appears in the processor output image. However, this data is not transferred to the thermocouple module. The outputs are held in their last state. When the slot is re-enabled, the current data in the processor image is transferred to the thermocouple module.

Channel Configuration, Data, and Status

This chapter examines the channel configuration word and the channel status word bit by bit, and explains how the module uses configuration data and generates status during operation. It gives you information about how to:

- configure a channel
- check a channel’s status

Channel Configuration

The channel configuration word is a part of the thermocouple module’s output image as shown below. Output words 0-3 correspond to channels 0-3 on the module. Output words 4-7 are not used.

After module installation each channel must be configured to establish the way the channel operates (e.g., thermocouple type J, reading in °C, etc.). You configure the channel by entering bit values into the configuration word using your programmer. A bit-by-bit examination of the configuration word is provided in the chart on page 5–3. Programming is discussed in chapter 6. Addressing is explained in chapter 4.

Module Output Image (Configuration Word)

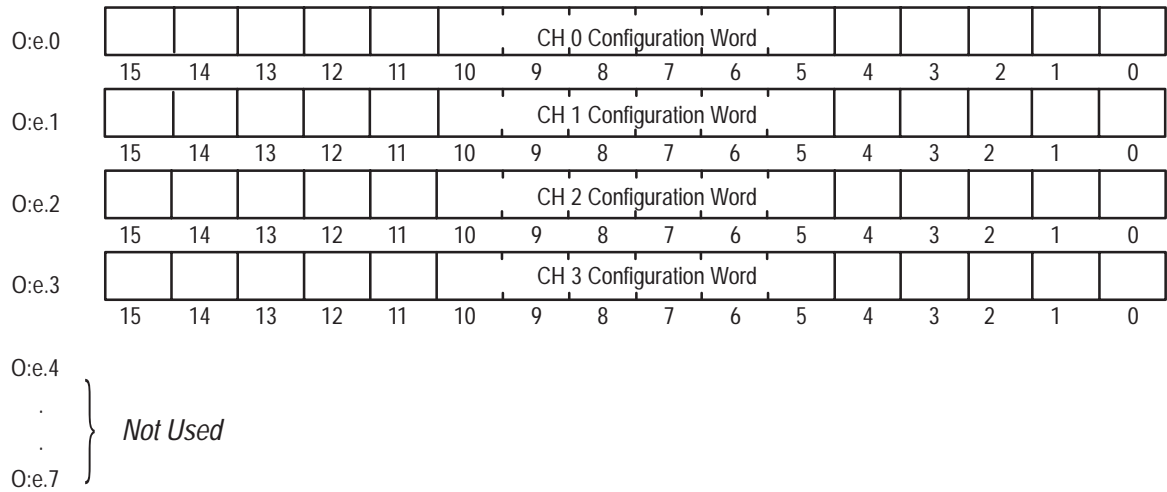

The configuration word default setting is all zeros.

Channel Configuration Procedure

The channel configuration word consists of bit fields, the settings of which determine how the channel will operate. This procedure looks at each bit field separately and helps you configure a channel for operation. Refer to the chart on page 5-3 and the bit field descriptions that follow for complete configuration information. Appendix B contains a configuration worksheet that can assist your channel configuration.

1. Determine the input device type (J, K, etc. thermocouple) (or mV) for a channel and enter its respective 4-digit binary code in bit field 0-3 of the channel configuration word.
2. Select a data format for the data word value. Your selection determines how the analog input value from the A/D converter will be expressed in the data word. Enter your 2-digit binary code in bit field 4-5 of the channel configuration word.
3. Determine the desired state for the channel data word if an open circuit condition is detected for that channel. Enter the 2-digit binary code in bit field 6-7 of the channel configuration word.
4. If the channel is configured for thermocouple inputs or the CJC sensor, determine if you want the channel data word to read in degrees Fahrenheit or degrees Celsius and enter a one or a zero in bit 8 of the configuration word. If the channel is configured for a mV analog sensor, enter a zero in bit 8.
5. Determine the desired input filter frequency for the channel and enter the 2-digit binary code in bit field 9-10 of the channel configuration word. A lower filter frequency increases the channel update time, but also increases the noise rejection and channel resolution. A higher filter frequency decreases the channel update time, but also decreases the noise rejection and effective resolution.
6. Determine which channels are used in your program and enable them. Place a one in bit 11 if the channel is to be enabled. Place a zero in bit 11 if the channel is to be disabled.
7. Ensure that bits 12-15 contain zeros.
8. Build the channel configuration word for every channel on each thermocouple/mV module repeating the procedures given in steps 1-7.
9. Following the steps outlined in chapter 2, Quick Start, or in chapter 6, Ladder Programming Examples, enter this configuration data into your ladder program and copy it to the thermocouple module.

Channel Configuration Word (O:e.0 through O:e.3) - Bit Definitions

| Bit(s) | Define | To Select | Make these bit settings in the Channel Configuration Word | | | | | | | | | | | | | | | |
|----------|--------------------------|-------------------------------------|---|----------|----------|----------|----|----|---|---|---|---|---|---|---|---|---|---|
| | | | 15 | 14 | 13 | 12 | 11 | 10 | 9 | 8 | 7 | 6 | 5 | 4 | 3 | 2 | 1 | 0 |
| 0-3 | Input type | Thermocouple Type J | | | | | | | | | | | | | 0 | 0 | 0 | 0 |
| | | Thermocouple Type K | | | | | | | | | | | | | 0 | 0 | 0 | 1 |
| | | Thermocouple Type T | | | | | | | | | | | | | 0 | 0 | 1 | 0 |
| | | Thermocouple Type E | | | | | | | | | | | | | 0 | 0 | 1 | 1 |
| | | Thermocouple Type R | Not used | Not used | Not used | Not used | | | | | | | | | 0 | 1 | 0 | 0 |
| | | Thermocouple Type S | Not used | Not used | Not used | Not used | | | | | | | | | 0 | 1 | 0 | 1 |
| | | Thermocouple Type B | Not used | Not used | Not used | Not used | | | | | | | | | 0 | 1 | 1 | 0 |
| | | Thermocouple Type N | | | | | | | | | | | | | 0 | 1 | 1 | 1 |
| | | ± 50mV | | | | | | | | | | | | | 1 | 0 | 0 | 0 |
| | | ± 100mV | | | | | | | | | | | | | 1 | 0 | 0 | 1 |
| | | Invalid | | | | | | | | | | | | | 1 | 0 | 1 | 0 |
| | | Invalid | | | | | | | | | | | | | 1 | 0 | 1 | 1 |
| | | Invalid | | | | | | | | | | | | | 1 | 1 | 0 | 0 |
| | | Invalid | Not used | Not used | Not used | Not used | | | | | | | | | 1 | 1 | 0 | 1 |
| | | CJC temperature | Not used | Not used | Not used | Not used | | | | | | | | | 1 | 1 | 1 | 1 |
| 4 and 5 | Data format | Engineering units × 1 ^① | | | | | | | | | | | 0 | 0 | | | | |
| | | Engineering units × 10 ^① | | | | | | | | | | | 0 | 1 | | | | |
| | | Scaled-for-PID | | | | | | | | | | | 1 | 0 | | | | |
| | | Proportional Counts | | | | | | | | | | | 1 | 1 | | | | |
| 6 and 7 | Open circuit | Zero | | | | | | | | | | 0 | 0 | | | | | |
| | | Upscale | | | | | | | | | | 0 | 1 | | | | | |
| | | Downscale | | | | | | | | | | 1 | 0 | | | | | |
| | | Invalid | Not used | Not used | Not used | Not used | | | | | | 1 | 1 | | | | | |
| 8 | Temperature units | Degrees C ^② | Not used | Not used | Not used | Not used | | | | 0 | | | | | | | | |
| | | Degrees F ^② | Not used | Not used | Not used | Not used | | | | 1 | | | | | | | | |
| 9 and 10 | Channel filter frequency | 10 Hz | | | | | | 0 | 0 | | | | | | | | | |
| | | 50 Hz | | | | | | 0 | 1 | | | | | | | | | |
| | | 60 Hz | | | | | | 1 | 0 | | | | | | | | | |
| | | 250 Hz | | | | | | 1 | 1 | | | | | | | | | |
| 11 | Channel enable | Channel Disabled | | | | | 0 | | | | | | | | | | | |
| | | Channel Enabled | | | | | 1 | | | | | | | | | | | |
| 12-15 | Unused | Unused ^③ | 0 | 0 | 0 | 0 | | | | | | | | | | | | |

^① For engineering units x1, values are expressed in 0.1 degrees or 0.01mV. For engineering units x10, values are expressed in 1.0 degrees or 0.1mV.

^② When millivolt input type is selected, the bit setting for temperature units is ignored.

^③ Ensure unused bits 12-15 are always be set to zeros.

Select Input Type (Bits 0-3)

The input type bit field lets you configure the channel for the type of input device you have connected to the module. Valid input devices are types J, K, T, E, R, S, B, and N thermocouple sensors and ± 50 mV and ± 100 mV analog input signals. The channel can also be configured to read the cold-junction temperature calculated for that specific channel. When the cold-junction compensation (CJC) temperature is selected, the channel ignores the physical input signal.

Select Data Format (Bits 4 and 5)

The data format bit field lets you define the expressed format for the channel data word contained in the module input image. The data types are engineering units, scaled-for-PID, and proportional counts.

The **engineering units** allow you to select from two resolutions, $\times 1$ or $\times 10$. For engineering units $\times 1$, values are expressed in 0.1 degrees or 0.01 mV. For engineering units $\times 10$, values are expressed in 1.0 degrees or 0.1 mV. (Use the $\times 10$ setting to produce temperature readings in whole degrees Celsius or Fahrenheit.)

The **scaled-for-PID** value is the same for millivolt, thermocouple, and CJC input types. The input signal range is proportional to your selected input type and scaled into a 0-16,383 range, which is standard to the SLC PID algorithm.

The **proportional counts** are scaled to fit the defined temperature or voltage range. The input signal range is proportional to your selected input and scaled into a (-32,768 to 32,767) range.

Using Scaled-for-PID and Proportional Counts

The thermocouple module provides eight options for displaying input channel data. These are 0.1°F, 0.1°C, 1°F, 1°C, 0.01 mV, 0.1 mV, Scaled-for-PID, and Proportional Counts. The first six options represent real Engineering Units provided/displayed by the 1746-NT4, and do not require explanation. The Scaled-for-PID and Proportional Counts selections provide the highest NT4 display resolution, but also require you to manually convert the channel data to real Engineering Units.

The equations on page 5-5 show how to convert from Scaled-for-PID to Engineering Units, Engineering Units to Scaled-for-PID, Proportional Counts to Engineering Units, and Engineering Units to Proportional Counts. To perform the conversions, you must know the defined temperature or millivolt range for the channel's input type. Refer to the Channel Data Word Format table on page 5-6. The lowest possible value for an input type is S_{LOW} , and the highest possible value is S_{HIGH} .

Scaling Examples

Scaled-for-PID to Engineering Units

Equation: $\text{Engr Units Equivalent} = S_{\text{LOW}} + [(S_{\text{HIGH}} - S_{\text{LOW}}) \times (\text{Scaled-for-PID value displayed} / 16384)]$

Assume type J input type, scaled-for-PID display type, channel data = 3421.

Want to calculate °C equivalent.

From Channel Data Word Format table, $S_{\text{LOW}} = -210^{\circ}\text{C}$ and $S_{\text{HIGH}} = 760^{\circ}\text{C}$.

Solution: $\text{Engr Units Equivalent} = -210^{\circ}\text{C} + [(760^{\circ}\text{C} - (-210^{\circ}\text{C})) \times (3421 / 16384)] = -7.46^{\circ}\text{C}$.

Engineering Units to Scaled-for-PID

Equation: $\text{Scaled-for-PID Equivalent} = 16384 \times [(\text{Engineering Units desired} - S_{\text{LOW}}) / (S_{\text{HIGH}} - S_{\text{LOW}})]$

Assume type J input type, scaled-for-PID display type, desired channel temp. = 344°C .

Want to calculate Scaled-for-PID equivalent.

From Channel Data Word Format table, $S_{\text{LOW}} = -210^{\circ}\text{C}$ and $S_{\text{HIGH}} = 760^{\circ}\text{C}$.

Solution: $\text{Scaled-for-PID Equivalent} = 16384 \times [(344^{\circ}\text{C} - (-210^{\circ}\text{C})) / (760^{\circ}\text{C} - (-210^{\circ}\text{C}))] = 9357$.

Proportional Counts to Engineering Units

Equation: $\text{Engr Units Equivalent} = S_{\text{LOW}} + \{ (S_{\text{HIGH}} - S_{\text{LOW}}) \times [(\text{Proportional Counts value displayed} + 32768) / 65536] \}$

Assume type E input type, proportional counts display type, channel data = 21567.

Want to calculate °F equivalent.

From Channel Data Word Format table, $S_{\text{LOW}} = -454^{\circ}\text{F}$ and $S_{\text{HIGH}} = 1832^{\circ}\text{F}$.

Solution: $\text{Engr Units Equivalent} = -454^{\circ}\text{F} + \{ [1832^{\circ}\text{F} - (-454^{\circ}\text{F})] \times [(21567 + 32768) / 65536] \} = 1441.3^{\circ}\text{F}$

Engineering Units to Proportional Counts

Equation: $\text{Proportional Counts Equivalent} = \{ 65536 \times [(\text{Engineering Units desired} - S_{\text{LOW}}) / (S_{\text{HIGH}} - S_{\text{LOW}})] \} - 32768$

Assume type E input type, proportional counts display type, desired channel temp. = 1000°F .

Want to calculate Proportional Counts equivalent.

From Channel Data Word Format table, $S_{\text{LOW}} = -454^{\circ}\text{F}$ and $S_{\text{HIGH}} = 1832^{\circ}\text{F}$.

Solution: $\text{Proportional Counts Equivalent} = \{ 65536 \times [(1000^{\circ}\text{F} - (-454^{\circ}\text{F})) / (1832^{\circ}\text{F} - (-454^{\circ}\text{F}))] \} - 32768 = 8916$.

1746-NT4 Thermocouple Module - Channel Data Word Format

| Input Type | Data Format | | | | | |
|------------|----------------------------|----------------------------|------------------------------|------------------------------|----------------|---------------------|
| | Engineering Units x 10 | | Engineering Units x 1 | | Scaled-for-PID | Proportional Counts |
| | ° Celsius | ° Fahrenheit | ° Celsius | ° Fahrenheit | | |
| J | -210 to 760 | -346 to 1400 | -2100 to 7600 | -3460 to 14000 | 0 to 16383 | -32768 to 32767 |
| K | -270 to 1370 | -454 to 2498 | -2700 to 13700 | -4540 to 24980 | 0 to 16383 | -32768 to 32767 |
| T | -270 to 400 | -454 to 752 | -2700 to 4000 | -4540 to 7520 | 0 to 16383 | -32768 to 32767 |
| E | -270 to 1000 | -454 to 1832 | -2700 to 10000 | -4540 to 18320 | 0 to 16383 | -32768 to 32767 |
| R | 0 to 1768 | 32 to 3214 | 0 to 17680 | 320 to 32140 | 0 to 16383 | -32768 to 32767 |
| S | 0 to 1768 | 32 to 3214 | 0 to 17680 | 320 to 32140 | 0 to 16383 | -32768 to 32767 |
| B | 300 to 1820 | 572 to 3308 | 3000 to 18200 | 5720 to 32767 ^① | 0 to 16383 | -32768 to 32767 |
| N | 0 to 1300 | 32 to 2372 | 0 to 13000 | 320 to 23720 | 0 to 16383 | -32768 to 32767 |
| ±50 mV | -500 to 500 ^② | -500 to 500 ^② | -5000 to 5000 ^② | -5000 to 5000 ^② | 0 to 16383 | -32768 to 32767 |
| ±100 mV | -1000 to 1000 ^② | -1000 to 1000 ^② | -10000 to 10000 ^② | -10000 to 10000 ^② | 0 to 16383 | -32768 to 32767 |
| CJC Sensor | 0 to 85 | 32 to 185 | 0 to 850 | 32 to 1850 | 0 to 16383 | -32768 to 32767 |

^① Type B thermocouple cannot be represented in engineering units x 1 (°F) above 3276.7°F. Software treats it as over range error.

^② When millivolts are selected, the temperature setting is ignored. Analog input data is the same for either °C or °F selection.

1746-NT4 Thermocouple Module - Channel Data Word Resolution

| Input Type | Data Format | | | | | | | |
|------------|------------------------|--------------|-----------------------|--------------|----------------|---------------|---------------------|---------------|
| | Engineering Units x 10 | | Engineering Units x 1 | | Scaled-for-PID | | Proportional Counts | |
| | ° Celsius | ° Fahrenheit | ° Celsius | ° Fahrenheit | ° Celsius | ° Fahrenheit | ° Celsius | ° Fahrenheit |
| J | 1°C/step | 1°F/step | 0.1°C/step | 0.1°F/step | 0.0592°C/step | 0.1066°F/step | 0.0148°C/step | 0.0266°F/step |
| K | 1°C/step | 1°F/step | 0.1°C/step | 0.1°F/step | 0.1001°C/step | 0.1802°F/step | 0.0250°C/step | 0.0450°F/step |
| T | 1°C/step | 1°F/step | 0.1°C/step | 0.1°F/step | 0.0409°C/step | 0.0736°F/step | 0.0102°C/step | 0.0184°F/step |
| E | 1°C/step | 1°F/step | 0.1°C/step | 0.1°F/step | 0.0775°C/step | 0.1395°F/step | 0.0194°C/step | 0.0349°F/step |
| R | 1°C/step | 1°F/step | 0.1°C/step | 0.1°F/step | 0.1079°C/step | 0.1942°F/step | 0.0270°C/step | 0.0486°F/step |
| S | 1°C/step | 1°F/step | 0.1°C/step | 0.1°F/step | 0.1079°C/step | 0.1942°F/step | 0.0270°C/step | 0.0486°F/step |
| B | 1°C/step | 1°F/step | 0.1°C/step | 0.1°F/step | 0.0928°C/step | 0.1670°F/step | 0.0232°C/step | 0.0417°F/step |
| N | 1°C/step | 1°F/step | 0.1°C/step | 0.1°F/step | 0.0793°C/step | 0.1428°F/step | 0.0198°C/step | 0.0357°F/step |
| ±50 mV | 0.1mV/step | 0.1mV/step | 0.01mV/step | 0.01mV/step | 6.104 μV/step | 6.104 μV/step | 1.526 μV/step | 1.526 μV/step |
| ±100 mV | 0.1mV/step | 0.1mV/step | 0.01mV/step | 0.01mV/step | 12.21 μV/step | 12.21 μV/step | 3.052 μV/step | 3.052 μV/step |
| CJC Sensor | 1°C/step | 1°F/step | 0.1°C/step | 0.1°F/step | 0.0052°C/step | 0.0093°F/step | 0.0013°C/step | 0.0023°F/step |

^① When millivolts are selected, the temperature setting is ignored. Analog input data is the same for either °C or °F selection.

Select Open Circuit State (Bits 6 and 7)

The open-circuit bit field lets you define the state of the channel data word when an open-circuit condition is detected for that channel. This feature is active for thermocouple input types, millivolt input types, and CJC device input.

An open-circuit condition occurs when the thermocouple itself or its extension wire is physically separated or open. This can happen if the wire gets cut or disconnected from the terminal block.

If either of the two CJC devices (thermistors) are removed from the module wiring terminal, any input channel configured for either a thermocouple or CJC temperature input will be placed in an open circuit condition. An input channel configured for millivolt input is not affected.

If **zero** is selected, the channel data word is forced to 0 during an open-circuit condition.

Selecting **upscale** forces the channel data word value to its full scale value during an open-circuit condition. The full scale value is determined by the selected input type and data format.

Selecting **downscale** forces the channel data word value to its low scale value during an open-circuit condition. The low scale value is determined by the selected input type and data format.

Important: You may receive up-ramping data values from the time the open circuit condition occurs until the condition is flagged. The NT4 requires 500 msec or one module update time, whichever is longer, to indicate the error. Depending on your program scan rate, ramping data may be written for several program scans after the open circuit occurs.

Select Temperature Units (Bit 8)

The temperature units bit lets you select temperature engineering units for thermocouple and CJC input types. Units are either degrees Celsius (°C) or degrees Fahrenheit (°F). This bit field is only active for thermocouple and CJC input types. It is ignored when millivolt inputs types are selected.

Important: If you use engineering units ($\times 1$ mode) and Fahrenheit temperature units (i.e. 0.1°F), the full scale temperature for thermocouple type B is not achievable with 15-bit numerical representation. An over range error will occur for that channel if it tries to represent the full scale value. The maximum representable temperature is 3276.7°F (instead of 3308°F).

Select Channel Filter Frequency (Bits 9 and 10)

The channel filter frequency bit field lets you select one of four filters available for a channel. The filter frequency affects the channel update time and noise rejection characteristics. A smaller filter frequency increases the channel update time, but also increases the noise rejection and channel resolution. A larger filter frequency decreases the noise rejection, but also decreases the channel update time and channel resolution.

- 250 Hz setting provides minimal noise filtering.
- 60 Hz setting provides 60 Hz AC line noise filtering.
- 50 Hz setting provides 50 Hz AC line noise filtering.
- 10 Hz setting provides both 50 Hz and 60 Hz AC line noise filtering.

When a CJC input type is selected, this field is ignored.

Select Channel Enable (Bit 11)

You use the channel enable bit to enable a channel. The thermocouple module only scans those channels that are enabled. To optimize module operation and minimize throughput times, *unused channels should be disabled* by setting the channel enable bit to zero.

When set (1) the **channel enable** bit is used by the module to read the configuration word information you have selected. While the enable bit is set, modification of the configuration word may lengthen the module update time for one cycle. If any change is made to the configuration word, the change must be reflected in the status word before new data is valid. (Refer to Channel Status on page 5-11.)

While the channel enable bit is cleared (0), the channel data word and status word values are cleared. After the channel enable bit is set, the channel data word and status word remain cleared until the thermocouple module sets the channel status bit (bit 11) in the channel status word.

Unused Bits (Bits 12-15)

Bits 12-15 are not defined. Ensure these bits are always cleared (0).

Channel Data Word

The actual thermocouple or millivolt input data values reside in I:e.0 through I:e.3 of the thermocouple module input image file. The values present will depend on the input type and data formats you have selected. When an input channel is disabled, its data word is reset (0).

Module Input Image (Data Word)

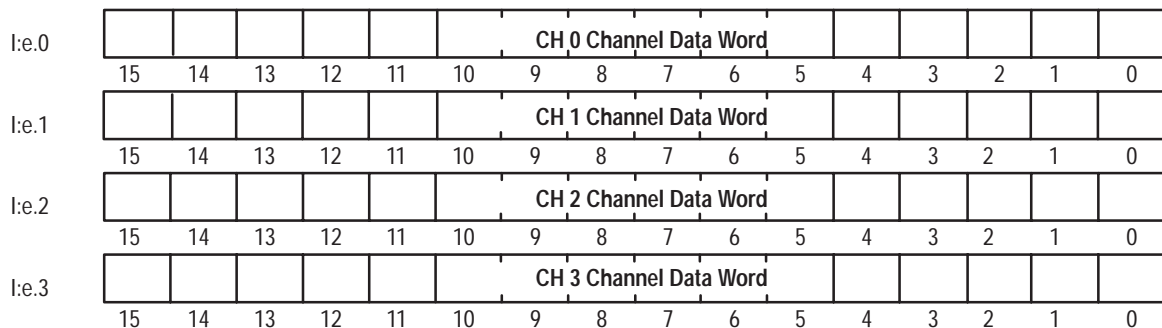

Channel Status Checking

The channel status word is a part of the thermocouple module's input image. Input words 4-7 correspond to and contain the configuration status of thermocouple channels 0, 1, 2, and 3 respectively. You can use the data provided in the status word to determine if the input configuration data for any channel is valid per your configuration in O:e.0 through O:e.3.

For example, whenever a channel is disabled ($O:e.x/11 = 0$), its corresponding status word shows all zeros. This condition tells you that input data contained in the data word for that channel is not valid and should be ignored.

Module Input Image (Status Word)

| | | | | | | | | | | | | | | | | | | | | | | | | | | | |
|-------|----|----|----|----|----|----|---|---|---|---|---|---|---|---|---|--------------------------|--------------------------|--|--|--|--|--|--|--|--|--|--|
| i.e.4 | | | | | | | | | | | | | | | | CH 0 Channel Status Word | | | | | | | | | | | |
| | 15 | 14 | 13 | 12 | 11 | 10 | 9 | 8 | 7 | 6 | 5 | 4 | 3 | 2 | 1 | 0 | | | | | | | | | | | |
| i.e.5 | | | | | | | | | | | | | | | | | CH 1 Channel Status Word | | | | | | | | | | |
| | 15 | 14 | 13 | 12 | 11 | 10 | 9 | 8 | 7 | 6 | 5 | 4 | 3 | 2 | 1 | 0 | | | | | | | | | | | |
| i.e.6 | | | | | | | | | | | | | | | | | CH 2 Channel Status Word | | | | | | | | | | |
| | 15 | 14 | 13 | 12 | 11 | 10 | 9 | 8 | 7 | 6 | 5 | 4 | 3 | 2 | 1 | 0 | | | | | | | | | | | |
| i.e.7 | | | | | | | | | | | | | | | | | CH 3 Channel Status Word | | | | | | | | | | |
| | 15 | 14 | 13 | 12 | 11 | 10 | 9 | 8 | 7 | 6 | 5 | 4 | 3 | 2 | 1 | 0 | | | | | | | | | | | |

The channel status word can be analyzed bit by bit. In addition to providing information about an enabled or disabled channel, each bit's status (0 or 1) tells you how the input data from the thermocouple or millivolt analog sensor connected to a specific channel will be translated for your application. The bit status also informs you of any error condition and can tell you what type error occurred.

A bit-by-bit examination of the status word is provided in the chart on the following pages.

Channel 0-3 Status Word (I:e.4 through I:e.7) - Bit Definitions

| Bit(s) | Define | These bit settings | | | | | | | | | | | | | | | | Indicate this | |
|----------|--------------------------|--------------------|----|----|----|----|----|---|---|---|---|---|---|---|---|---|-----------------|-------------------------------------|---------------------|
| | | 15 | 14 | 13 | 12 | 11 | 10 | 9 | 8 | 7 | 6 | 5 | 4 | 3 | 2 | 1 | 0 | | |
| 0-3 | Input type | | | | | | | | | | | | | 0 | 0 | 0 | 0 | Thermocouple Type J | |
| | | | | | | | | | | | | | | | 0 | 0 | 0 | 1 | Thermocouple Type K |
| | | | | | | | | | | | | | | | 0 | 0 | 1 | 0 | Thermocouple Type T |
| | | | | | | | | | | | | | | | 0 | 0 | 1 | 1 | Thermocouple Type E |
| | | | | | | | | | | | | | | | 0 | 1 | 0 | 0 | Thermocouple Type R |
| | | | | | | | | | | | | | | | 0 | 1 | 0 | 1 | Thermocouple Type S |
| | | | | | | | | | | | | | | | 0 | 1 | 1 | 0 | Thermocouple Type B |
| | | | | | | | | | | | | | | | 0 | 1 | 1 | 1 | Thermocouple Type N |
| | | | | | | | | | | | | | | | 1 | 0 | 0 | 0 | ± 50 mV |
| | | | | | | | | | | | | | | | 1 | 0 | 0 | 1 | ± 100 mV |
| | | | | | | | | | | | | | | | 1 | 0 | 1 | 0 | Invalid |
| | | | | | | | | | | | | | | | 1 | 0 | 1 | 1 | Invalid |
| | | | | | | | | | | | | | | | 1 | 1 | 0 | 0 | Invalid |
| | | | | | | | | | | | | | | | 1 | 1 | 0 | 1 | Invalid |
| | | | | | | | | | | | | | 1 | 1 | 1 | 1 | CJC temperature | | |
| 4 and 5 | Data type | | | | | | | | | | | 0 | 0 | | | | | Engineering units × 1 ^① | |
| | | | | | | | | | | | | 0 | 1 | | | | | Engineering units × 10 ^① | |
| | | | | | | | | | | | | 1 | 0 | | | | | Scaled-for-PID | |
| | | | | | | | | | | | | 1 | 1 | | | | | Proportional Counts | |
| 6 and 7 | Open circuit type | | | | | | | | | 0 | 0 | | | | | | | Zero | |
| | | | | | | | | | | 0 | 1 | | | | | | | Upscale | |
| | | | | | | | | | | 1 | 0 | | | | | | | Downscale | |
| | | | | | | | | | | 1 | 1 | | | | | | | Invalid | |
| 8 | Temperature units type | | | | | | | 0 | | | | | | | | | | Degrees C ^② | |
| | | | | | | | | 1 | | | | | | | | | | Degrees F ^② | |
| 9 and 10 | Channel filter frequency | | | | | | 0 | 0 | | | | | | | | | | 10 Hz | |
| | | | | | | | 0 | 1 | | | | | | | | | | 50 Hz | |
| | | | | | | | 1 | 0 | | | | | | | | | | 60 Hz | |
| | | | | | | | 1 | 1 | | | | | | | | | | 250 Hz | |
| 11 | Channel status | | | | | 0 | | | | | | | | | | | | Channel Disabled | |
| | | | | | | 1 | | | | | | | | | | | | Channel Enabled | |
| 12 | Open-circuit error | | | | 0 | | | | | | | | | | | | | No error | |
| | | | | | 1 | | | | | | | | | | | | | Open circuit detected | |
| 13 | Under-range error | | | 0 | | | | | | | | | | | | | | No error | |
| | | | | 1 | | | | | | | | | | | | | | Under-range condition | |
| 14 | Over-range error | | 0 | | | | | | | | | | | | | | | No error | |
| | | | 1 | | | | | | | | | | | | | | | Over-range condition | |
| 15 | Configuration error | 0 | | | | | | | | | | | | | | | | No error | |
| | | 1 | | | | | | | | | | | | | | | | Configuration error | |

^① For engineering units x1, values are expressed in 0.1 degrees or 0.01 mV. For engineering units x10, values are expressed in 1.0 degrees or 0.1 mV.

^② When millivolt input type is selected, the bit setting for temperature units does not apply.

Important: If the channel for which you are seeking status is disabled (bit 0:e.x/11 = 0), all bit fields are cleared. The status word for any disabled channel is always 0000 0000 0000 0000 regardless of any previous setting that may have been made to the configuration word.

Explanations of the status conditions follow.

Input Type Status (Bits 0-3)

The input type bit field indicates what type of input signal you have configured for the channel. This field reflects the input type defined in the channel configuration word.

Data Format Type Status (Bits 4 and 5)

The data format bit field indicates the data format you have defined for the channel. This field reflects the data type selected in bits 4 and 5 of the channel configuration word.

Open Circuit Type Status (Bits 6 and 7)

The open-circuit bit field indicates how you have defined the configuration word and, therefore, the response of the thermocouple module to an open-circuit condition. This feature is active for all input types, including CJC temperature input.

Temperature Units Type Status (Bit 8)

The temperature units field indicates the state of the temperature units bit in the configuration word (bit 8).

Channel Filter Frequency (Bits 9 and 10)

The channel filter frequency bit field reflects the filter frequency you selected in the configuration word.

Channel Status (Bit 11)

The channel status bit indicates the operational state of the channel. When the channel enable bit is set in the configuration word (bit 11), the thermocouple module configures the selected channel and takes a data sample for the channel data word before setting this bit in the status word.

Allen-Bradley Drives

Open-Circuit Error (Bit 12)

This bit is set (1) whenever a configured channel detects an open-circuit condition at its input. An open circuit at the CJC sensor will also flag this error if the channel input type is either thermocouple or CJC temperature.

Under-Range Error (Bit 13)

This bit is set (1) whenever a configured channel detects an under-range condition for the channel data. An under-range condition exists when the input value is below the specified lower limit of the particular sensor connected to that channel. An under-range temperature at the CJC sensor will also flag this error if the channel input type is either thermocouple or CJC temperature.

Over-Range Error (Bit 14)

This bit is set (1) whenever a configured channel detects an over-range condition for the channel data. An over-range condition exists when the input value is above the specified upper limit of the particular sensor connected to that channel. An over-range temperature at the CJC sensor will also flag this error if the channel input type is either thermocouple or CJC temperature.

Configuration Error (Bit 15)

This bit is set (1) whenever a configured channel detects that the channel configuration word is not valid. All other status bits reflect the settings from the configuration word (even those settings that may be in error).

Ladder Programming Examples

Earlier chapters explained how the configuration word defines the way a channel operates. This chapter shows the programming required to enter the configuration word into the processor memory. It also provides you with segments of ladder logic specific to unique situations that might apply to your programming requirements. The example segments include:

- initial programming of the configuration word
- dynamic programming of the configuration word
- verifying channel configuration changes
- interfacing the thermocouple module to a PID instruction
- monitoring channel status bits
- invoking autocalibration

Initial Programming

To enter data into the channel configuration word (O:e.0 through O:e.3) when the channel is disabled (bit 11 = 0), follow these steps. Refer to page 5–3 for specific configuration details.

Example - Configure four channels of a thermocouple module residing in slot 3 of a 1746 chassis. Configure each channel with the same parameters.

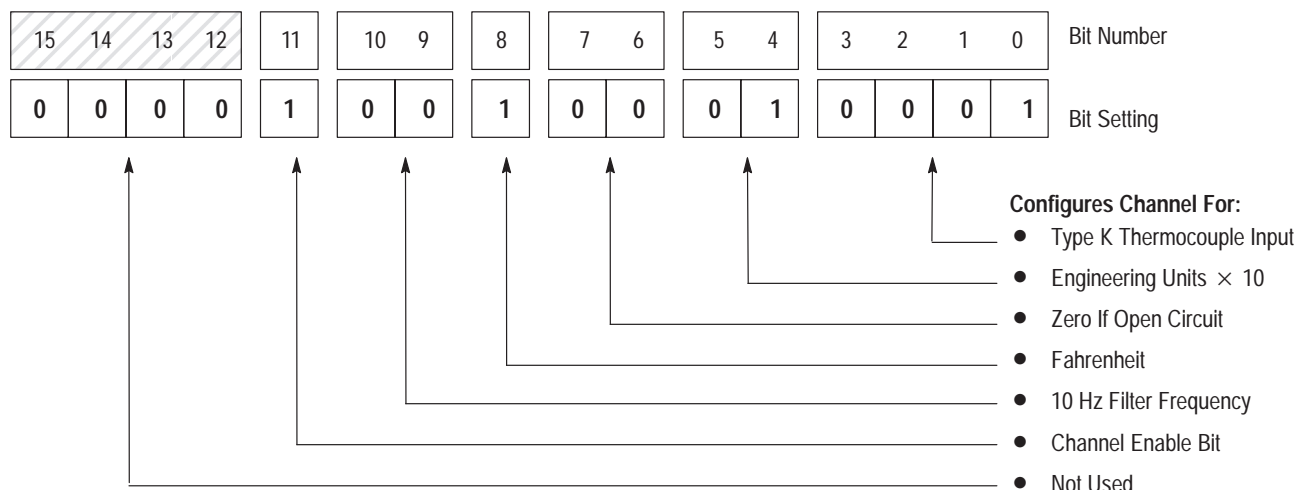

This example transfers configuration data and sets the channel enable bits of all four channels with a single File Copy instruction.

Procedure

1. Create integer file N10. Integer file N10 should contain four elements (N10:0 through N10:3).
2. Enter the configuration parameters for all four thermocouple channels into a source integer data file **N10**. See Appendix A for a channel configuration worksheet.
3. Program a rung in your ladder logic to copy the contents of integer file N10 to the four consecutive output words of the thermocouple module beginning with O:3.0.

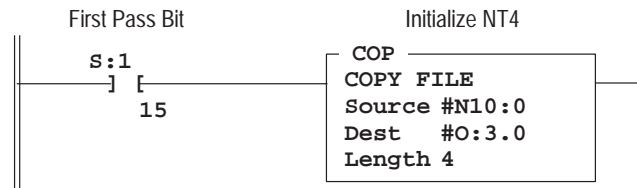

On power up, bit S:1/15 is set for the first program scan, and integer file N10 is sent to the NT4 channel configuration words.

Dynamic Programming

The following example explains how to change data in the channel configuration word when the channel is currently enabled.

Example - Execute a dynamic configuration change to channel 2 of the thermocouple module located in slot 3 of a 1746 chassis. Change from monitoring an external type K thermocouple to monitoring the CJC sensors mounted on the terminal block. This gives a good indication of what the temperature is inside the control cabinet. Finally, set channel 2 back to type K thermocouple.

Program Listing

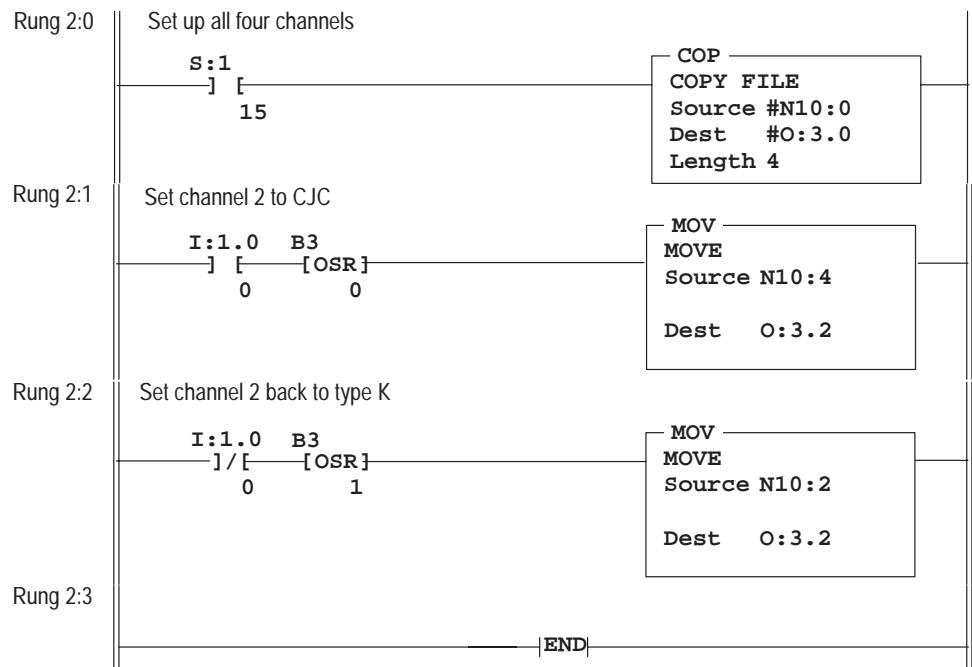

Data Table

| address | 15 | data | 0 | address | 15 | data | 0 |
|---------|------|-----------|------|---------|------|-----------|------|
| N10:0 | 0000 | 1001 0001 | 0001 | N10:3 | 0000 | 1001 0001 | 0001 |
| N10:1 | 0000 | 1001 0001 | 0001 | N10:4 | 0000 | 1001 0001 | 1111 |
| N10:2 | 0000 | 1001 0001 | 0001 | | | | |

Important: While the module performs the configuration alteration, it does not monitor input device data change at any channel. Refer to page 4-8, *Channel Turn-On, Turn-Off, and Reconfiguration Times*.

Verifying Channel Configuration Changes

When executing a dynamic channel configuration change, there will always be a delay from the time the ladder program makes the change to the time the NT4 gives you a data word using that new configuration information. Therefore, it is very important to verify that a dynamic channel configuration change took effect in the NT4 module, particularly if the channel being dynamically configured is used for control. The following example explains how to verify that channel configuration changes have taken effect.

Example - Execute a dynamic configuration change to channel 2 of the thermocouple module located in slot 3 of a 1746 chassis, and set an internal “data valid” bit when the new configuration has taken effect.

Program Listing

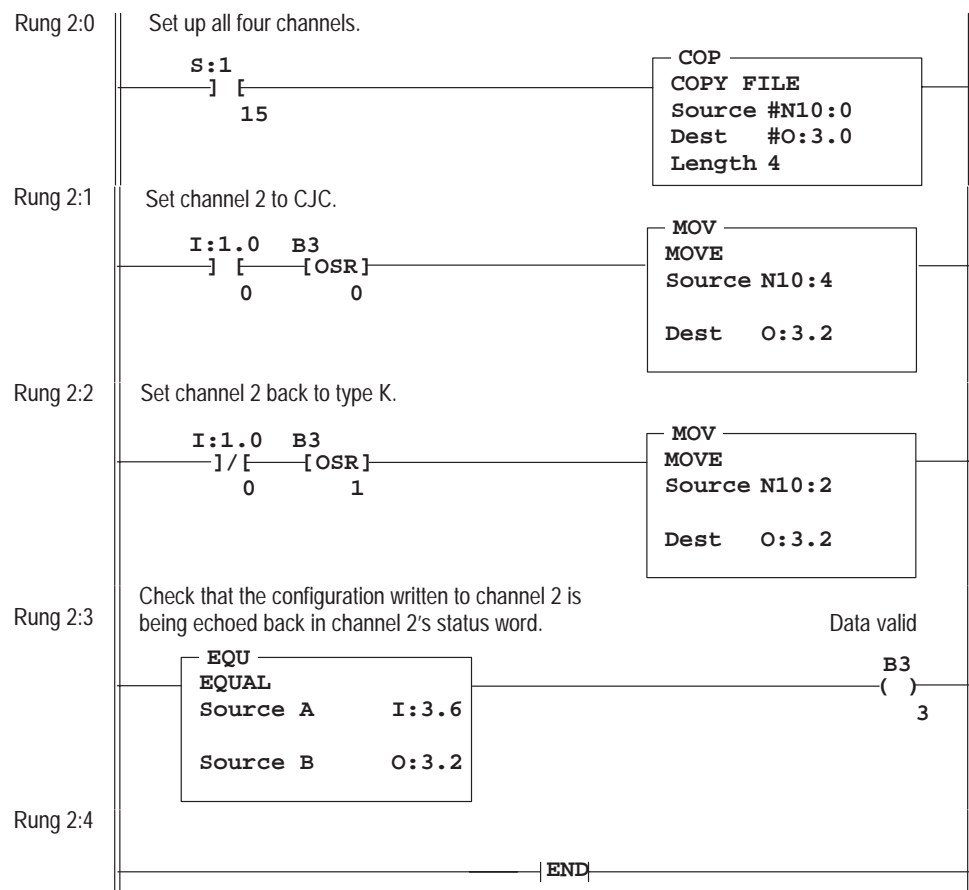

Data Table

| address | 15 | data | 0 | address | 15 | data | 0 | | |
|---------|------|------|------|---------|-------|------|------|------|------|
| N10:0 | 0000 | 1001 | 0001 | 0001 | N10:3 | 0000 | 1001 | 0001 | 0001 |
| N10:1 | 0000 | 1001 | 0001 | 0001 | N10:4 | 0000 | 1001 | 0001 | 1111 |
| N10:2 | 0000 | 1001 | 0001 | 0001 | | | | | |

Interfacing to the PID Instruction

The thermocouple module was designed to interface directly to the SLC 5/02™ or later processor PID instruction without the need for an intermediate scale operation.

Example - Use NT4 channel data as the process variable in the PID instruction.

1. Select *scaled-for-PID* as the data type in the channel configuration word.
2. Specify the thermocouple channel data word as the process variable for the PID instruction.

Program Listing

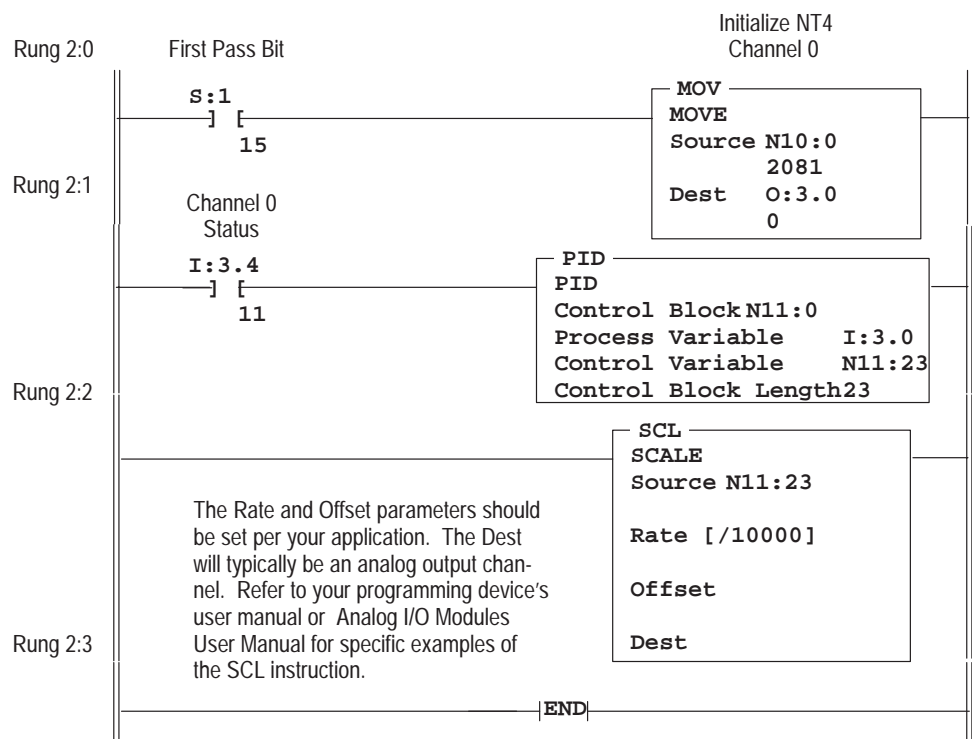

Data Table

| address | 15 | data | 0 | address | 15 | data | 0 |
|---------|----|------|------|---------|------|------|---|
| N10:0 | | 0000 | 1000 | 0010 | 0001 | | |

Invoking Autocalibration

Autocalibration of a channel occurs whenever a channel is enabled, or when a change is made to its input type or filter frequency. You can also command your module to perform an autocalibration cycle by disabling a channel, waiting for the status bit to change state (1 to 0) and then re-enabling that channel. Several channel cycles are required to perform an autocalibration (refer to page 4-8), and it is important to remember that during autocalibration the module is not converting input data.

To maintain system accuracy we recommend that you periodically perform an autocalibration cycle, for example:

- whenever an event occurs that greatly changes the internal temperature of the control cabinet, such as opening or closing its door
- at a convenient time when the system is not making product, such as during a shift change

Several channel cycles are required to perform an autocalibration, and it is important to remember that during autocalibration the module is not converting input data.

Example - Command the NT4 to perform an autocalibration of channel 0. The NT4 is in slot 3.

Program Listing

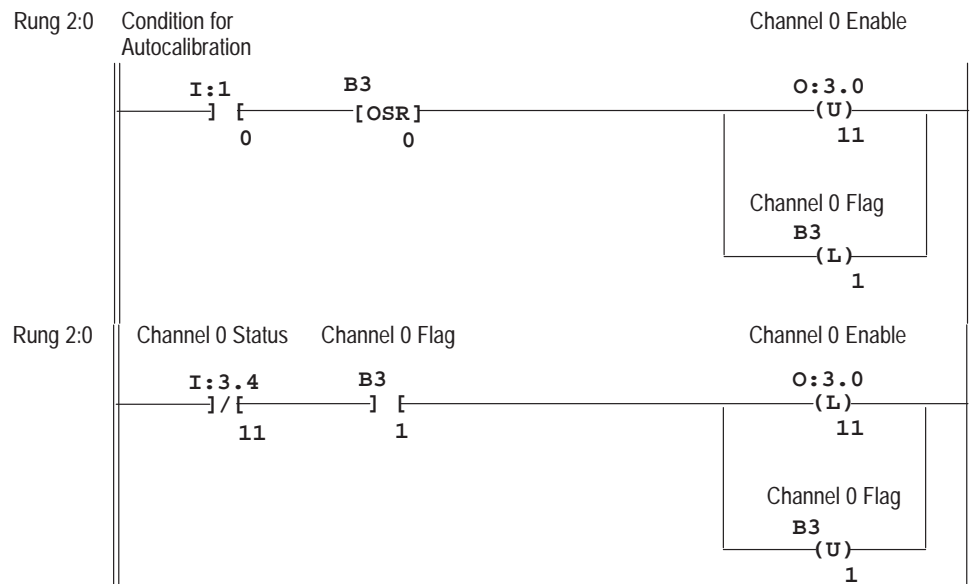

Important: The NT4 responds to processor commands much more frequently than it updates its own LEDs. Therefore, it is normal to execute these two rungs and have the NT4 perform an autocalibration of channel 0 without the channel 0 LED ever changing state.

Module Diagnostics and Troubleshooting

This chapter describes troubleshooting using the channel status LEDs as well as the module status LED. It explains the types of conditions that might cause an error to be reported and gives suggestions on how to resolve the problem. Major topics include:

- module operation vs. channel operation
- power-up diagnostics
- channel diagnostics
- LED indicators
- troubleshooting flowchart
- replacement parts
- contacting Allen-Bradley

Module Operation vs. Channel Operation

The thermocouple module performs operations at two levels:

- module level operations
- channel level operations

Module level operations include functions such as power-up configuration and communication with the SLC processor.

Channel level operations describe channel-related functions, such as data conversion and open-circuit detection.

Internal diagnostics are performed at both levels of operation and any error conditions detected are immediately indicated by the module's LEDs.

Power-Up Diagnostics

At module powerup, a series of internal diagnostic tests is performed. These diagnostic tests must be successfully completed or a module error results and the module status LED remains off.

Channel Diagnostics

When a channel is enabled (bit 11 = 1), a diagnostic check is performed to see that the channel has been properly configured. In addition the channel is tested for out-of-range and open-circuit faults on every scan. If the channel is configured for thermocouple input or CJC input, the CJC sensors are also checked for out-of-range and open circuits.

A failure of any channel diagnostic test causes the faulted channel status LED to blink. All channel faults are indicated in bits 12-15 of the channel's status word. Channel faults are self-clearing, and the channel LED will stop blinking and resume steady illumination when the fault conditions are corrected.

Important: If you clear (0) a channel enable bit (11) all channel status information is reset.

LED Indicators

The thermocouple module has five LEDs. Four of these are channel status LEDs numbered to correspond to each of the thermocouple's input channels, and one is a module status LED.

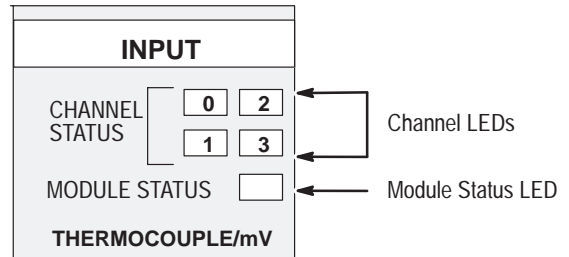

LED State Table

| If Module Status LED is: | And Channel Status LED is: | Indicated Condition: | Corrective action: |
|--------------------------|----------------------------|---|--|
| On | On | Channel Enabled | No action required. |
| | Blinking | Open Circuit Condition | To determine the exact error, check the error bits in the input image. Check the channel configuration word for valid data. Make sure that the input type is indicated correctly in bits 0-3, and that the open circuit selection state (bits 6 and 7) is valid. Refer to the troubleshooting flowchart on page 7-5 and to chapter 5 for more information. |
| | | Out-of-Range Condition | |
| | | Channel Configuration Error | |
| | Off | Power-Up | No action required. |
| Channel Not Enabled | | No action required. For an example of how to enable a channel refer to chapter 2, Quick Start, or chapter 6, Ladder Programming Examples. | |

Module Status LED State Table

| If Module Status LED is: | Indicated condition: | Corrective action: |
|--------------------------|----------------------|--|
| On | Proper Operation | No action required. |
| Off | Module Fault | Cycle power. If condition persists, call your local distributor or Allen-Bradley for assistance. |

Channel Status LEDs (Green)

The channel LED is used to indicate channel status and related error information contained in the channel status word. This includes conditions such as:

- normal operation
- channel-related configuration errors
- open circuit errors
- out-of-range errors

All channel errors are recoverable errors and after corrective action, normal operation resumes.

Invalid Channel Configuration

Whenever a channel's configuration word is improperly defined, the channel LED blinks and bit 15 of the channel status word is set. Configuration errors occur when the input type (bits 0-3 in the channel configuration word) is invalid, or when the open circuit state selection (bits 6 and 7) is invalid.

Open Circuit Detection

An open-circuit test is performed on all enabled channels. Whenever an open circuit condition occurs (see possible causes listed below), the channel LED blinks and bit 12 of the channel status word is set.

Possible causes of an open circuit include:

- The thermocouple may be broken.
- A thermocouple wire may be loose or cut.
- The thermocouple may not have been installed on the configured channel.
- The CJC may be damaged.

If a damaged CJC termination is the cause of the detected open circuit condition, the status LED for each channel configured for thermocouple or CJC input blinks.

If an open-circuit is detected, the channel data word reflects input data as defined by the open-circuit bits (6 and 7) in the channel configuration word.

Out-Of-Range Detection

Whenever the data received at the channel data word is out of the defined operating range, an over-range or under-range error is indicated and bit 13 (under-range) or 14 (over-range) of the channel status word is set. Refer to the temperature ranges provided in the table on page 5–7 for a review of the temperature range limitations for your input device.

Possible causes of an out-of-range condition include:

- The temperature is too hot or too cold for the thermocouple being used.
- A type B thermocouple may be registering a °F value in engineering units x 1 that cannot be expressed by the data bits. Refer to page 5–9 for more information.
- A CJC may be damaged or the temperature within the cabinet containing the module may be outside the CJC range limits.

Module Status LED (Green)

The module status LED is used to indicate module-related diagnostic or operating errors. These *non-recoverable errors* may be detected at power-up or during module operation. Once in a module error state, the thermocouple module no longer communicates with the SLC processor. Channel states are disabled, and data words are cleared (0).

Failure of any diagnostic test results in a non-recoverable error and requires the assistance of your local distributor or Allen-Bradley.

Troubleshooting Flowchart

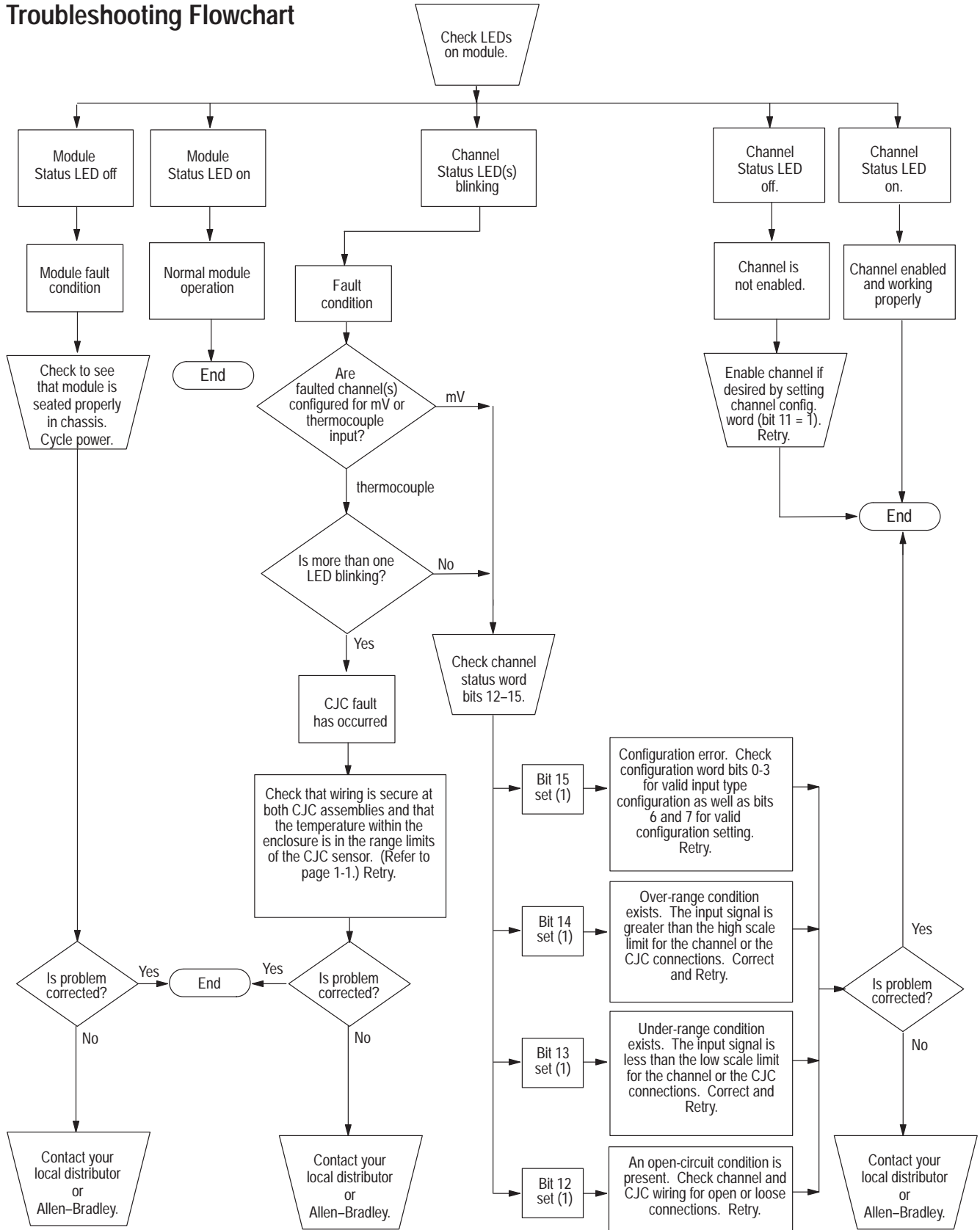

Replacement Parts

The NT4 module has the following replaceable parts:

| Part | Part Number |
|----------------------------|-------------------|
| Replacement Terminal Block | 1746-RT32 |
| Replacement Terminal Cover | 1746-R13 Series B |
| 1746-NT4 User Manual | 1746-6.6 |

Contacting Allen-Bradley

If you need to contact Allen-Bradley for assistance, please have the following information available when you call:

- a clear statement of the problem including a description of what the system is actually doing. Note and record the LED states; also, note input and output image words for the NT4 module.
- a list of things you have already tried to remedy the problem
- processor type, 1747-NT4 series letter, and firmware (FRN) number. See label on left side of processor.
- hardware types in the system including I/O modules and chassis
- fault code if the SLC processor is faulted

Allen-Bradley Drives

Application Examples

This chapter provides two application examples to help you use the thermocouple input module. They are defined as a:

- basic example
- supplementary example

The **basic example** builds on the configuration word programming provided in chapter 6 to set up one channel for operation. This setup is then used in a typical application to display temperature.

The **supplementary example** demonstrates how to perform a dynamic configuration of all four channels. The example sets up an application that allows you to manually select whether the displayed thermocouple input data for any channel is expressed in °C or °F.

Basic Example

Application Setup (Display a Temperature)

This example indicates the temperature of a bath on an LED display. The display requires BCD data, so the program must convert the temperature reading from the thermocouple module to BCD before sending it to the display. This application will display the temperature in °F.

Device Configuration

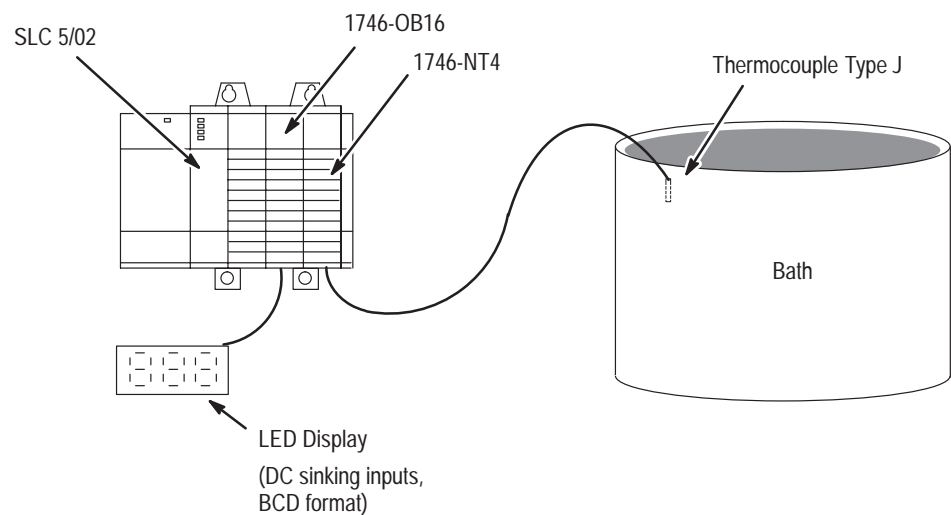

Channel Configuration

Configure the thermocouple channel with the following setup:

- type J thermocouple
- °F - display to whole degree
- zero data word in the event of an open circuit
- 10 Hz input filter to reject high frequency noise and give good rejection of 60 Hz line noise

Channel Configuration Worksheet (With Settings Established for Channel 0)

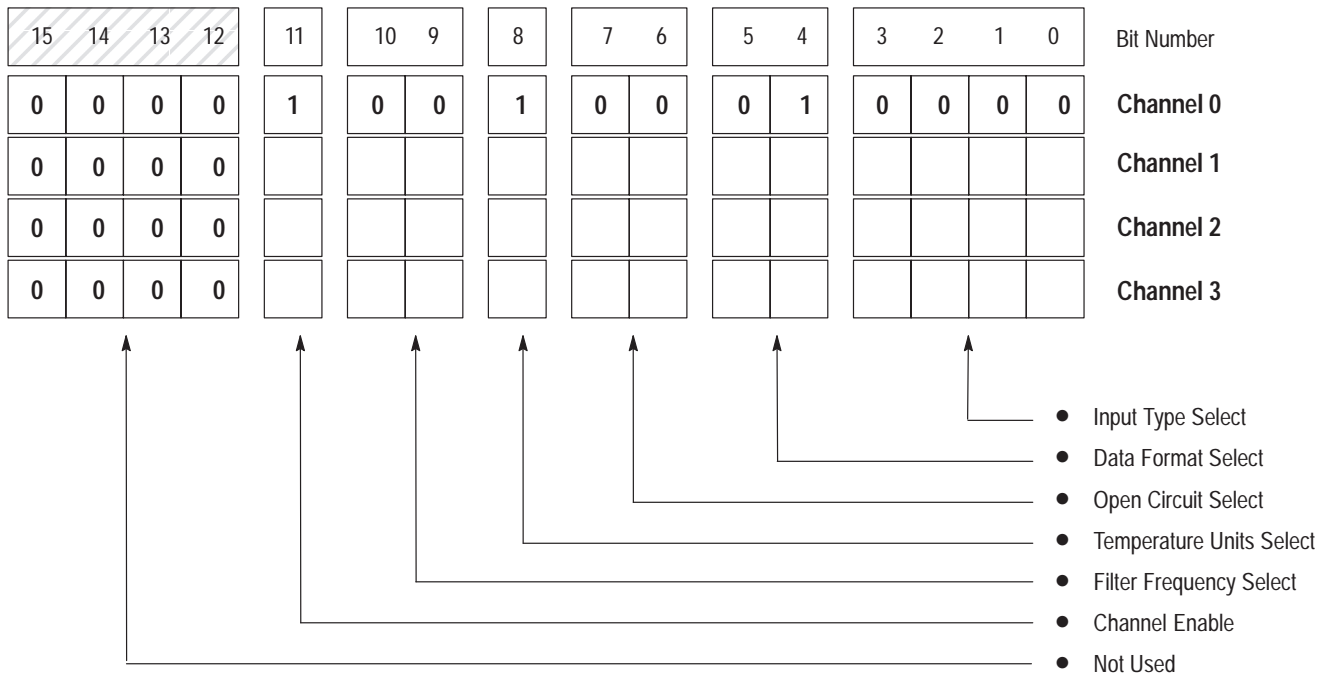

| Bit Definitions: | | | | | |
|------------------|--------------------------|--|--|---|------------------------|
| Bits 0-3 | Input Type Select | 0000 = J 0001 = K 0010 = T 0011 = E | 0100 = R 0101 = S 0110 = B 0111 = N | 1000 = ±50mV 1001 = ±100mV | 1111 = CJC temperature |
| Bits 4 and 5 | Data Format Select | 00 = engineering units, x1 (0.1°/step, 0.01mV/step) 01 = engineering units, x10 (1°/step, 0.1mV/step) | | 10 = scaled-for-PID (0 to 16383) 11 = proportional counts (-32768 to +32767) | |
| Bits 6 and 7 | Open Circuit Select | 00 = zero | 01 = upscale | 10 = downscale | |
| Bit 8 | Temperature Units Select | 0 = degrees Celsius 1 = degrees Fahrenheit | | | |
| Bits 9 and 10 | Filter Frequency Select | 00 = 10 Hz | 01 = 50 Hz | 10 = 60 Hz | 11 = 250 Hz |
| Bit 11 | Channel Enable | 0 = channel disabled 1 = channel enabled | | | |
| Bits 12-15 | Not Used | 0000 = always make this setting | | | |

Program Listing

Rung 2.0

Initialize Channel 0
of NT4



Rung 2.1

Convert the channel 0 data word (degrees F) to BCD and write this to the LED display.
If channel 0 is ever disabled, a zero is written to the display.

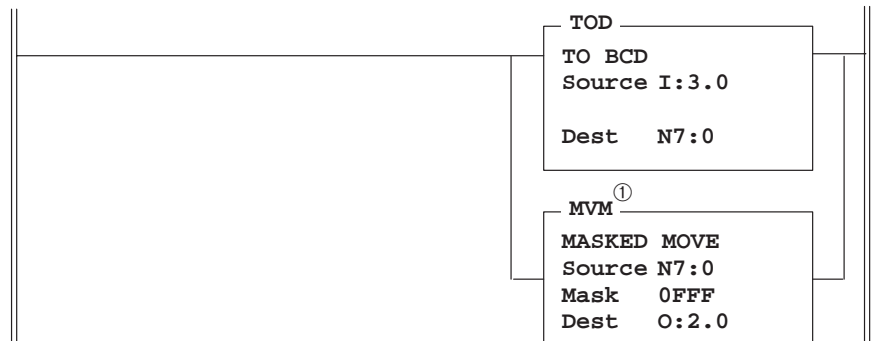

Rung 2.2

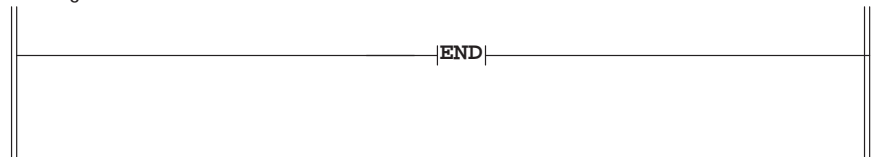

- ① The use of the masked move instruction with the OFFF mask allows you to use outputs 12, 13, 14, and 15 for other output devices in your system. The 7-segment display uses outputs 0-11.

Data Table

| address | 15 | data | 0 | address | 15 | data | 0 |
|---------|------|-----------|------|---------|----|------|---|
| N10:0 | 0000 | 1001 0001 | 0000 | | | | |

Allen-Bradley Drives

Supplementary Example

Application Setup (Four Channels °C ↔ °F)

This example shows how to display the temperature of several different thermocouples at one annunciator panel. A selector switch (I:2/0) allows the operator to choose between displaying data in °C and °F. A second selector switch (I:2/1) allows the operator to switch one of the displays between the ambient temperature near the bath and the temperature inside of the control cabinet that houses the SLC 500. Each of the displays is a 4-digit, 7-segment LED display with the last digit representing tenths of a degree. The displays have DC-sinking inputs and use a BCD data format.

Device Configuration

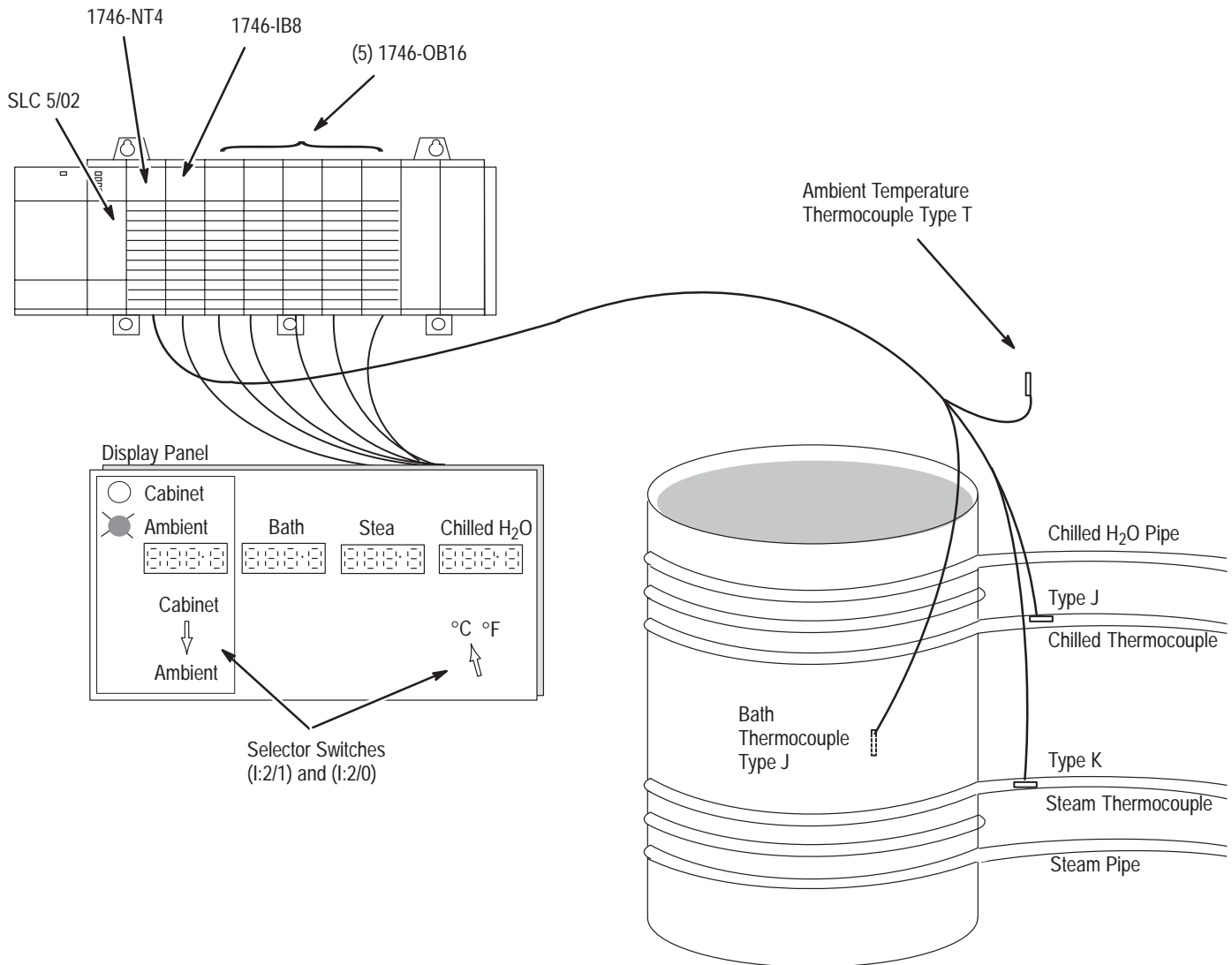

Channel Configuration

Configuration setup for **ambient thermocouple**:

- channel 0
- type T thermocouple
- display temperature to tenths of a degree
- zero data word in the event of an open circuit
- 60 Hz input filter to provide 60 Hz line noise rejection

Configuration setup for **bath thermocouple**:

- channel 1
- type J thermocouple
- display temperature to tenths of a degree
- zero data word in the event of an open circuit
- 60 Hz input filter to provide 60 Hz line noise rejection

Configuration setup for **steam thermocouple**:

- channel 2
- type K thermocouple
- display temperature to tenths of a degree
- zero data word in the event of an open circuit
- 60 Hz input filter to provide 60 Hz line noise rejection

Configuration setup for **chilled H₂O thermocouple**:

- channel 3
- type J thermocouple
- display temperature to tenths of a degree
- zero data word in the event of an open circuit
- 60 Hz input filter to provide 60 Hz line noise rejection

Configuration setup for **cabinet temperature**:

- channel 0
- CJC temperature
- display temperature to tenths of a degree
- zero data word in the event of an open circuit
- 60 Hz input filter to provide 60 Hz line noise rejection

Channel Configuration Worksheet (With Settings Established)

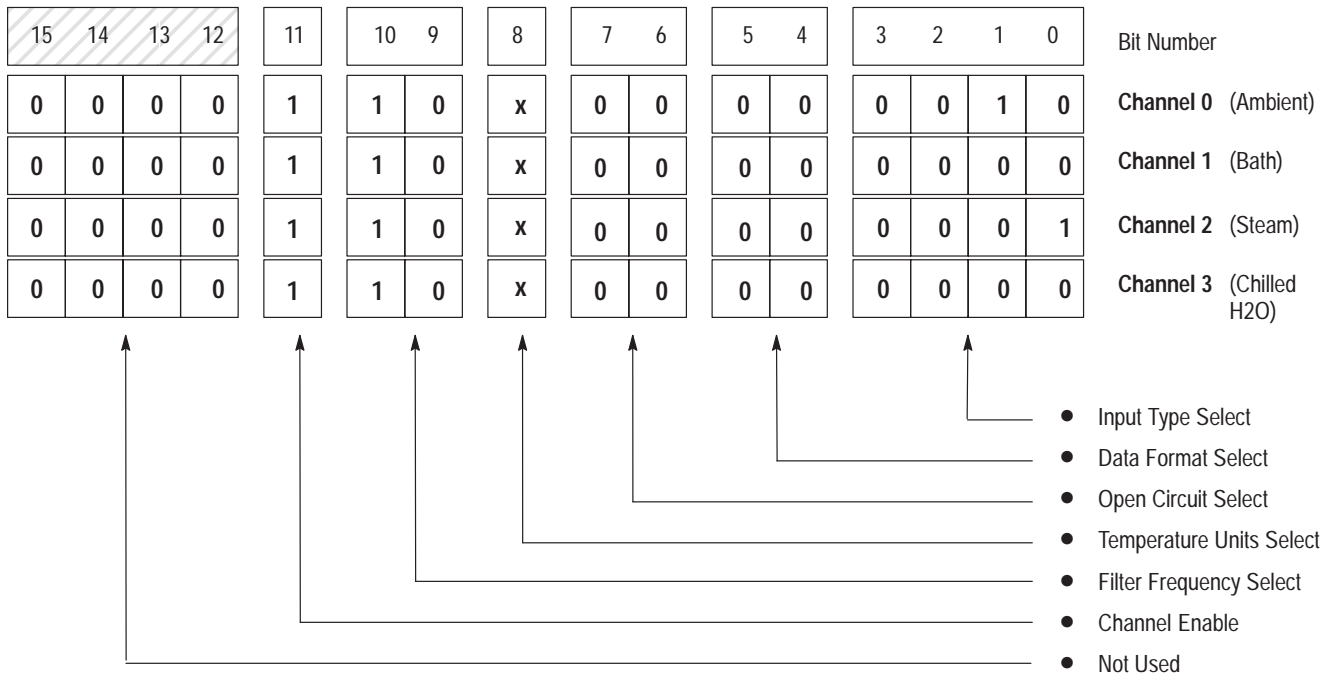

Bit

Definitions:

| | | | | |
|----------------------|--------------------------|--|--|---|
| Bits 0-3 | Input Type Select | 0000 = J 0001 = K 0010 = T 0011 = E | 0100 = R 0101 = S 0110 = B 0111 = N | 1000 = ±50mV 1001 = ±100mV 1111 = CJC temperature |
| Bits 4 and 5 | Data Format Select | 00 = engineering units, x1 (0.1°/step, 0.01mV/step) 01 = engineering units, x10 (1°/step, 0.1mV/step) | | 10 = scaled-for-PID (0 to 16383) 11 = proportional counts (-32768 to +32767) |
| Bits 6 and 7 | Open Circuit Select | 00 = zero | 01 = upscale | 10 = downscale |
| Bit 8 | Temperature Units Select | 0 = degrees Celsius | 1 = degrees Fahrenheit | |
| Bits 9 and 10 | Filter Frequency Select | 00 = 10 Hz | 01 = 50 Hz | 10 = 60 Hz 11 = 250 Hz |
| Bit 11 | Channel Enable | 0 = channel disabled 1 = channel enabled | | |
| Bits 12-15 | Not Used | 0000 = always make this setting | | |

Program Setup and Operation Summary

- Set up two configuration words in memory for each channel, one for °C and the other for °F. In addition, set up two configuration words to monitor the thermocouple's CJC temperature. Monitoring the CJC temperature gives a good indication of the temperature inside of the control cabinet the SLC is mounted in. The table below shows the configuration word allocation summary.

| Channel | Configuration Word Allocation | |
|---------|-------------------------------|--------------|
| | °F | °C |
| 1 | N10:0 | N10:4 |
| 2 | N10:1 | N10:5 |
| 3 | N10:2 | N10:6 |
| 4 | N10:3 | N10:7 |
| CJC | N10:8 | N10:9 |

- When the positions of the degrees selector switch or ambient/cabinet selector switch change, write the appropriate channel configurations to the NT4 module. Note that the use of the OSR instruction (one-shot rising) makes these configuration changes edge-triggered, i.e. the NT4 is reconfigured only when a selector switch changes position.

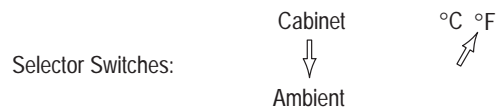

- Monitor the channel 0 status word to determine which temperature is being displayed (ambient or cabinet) and energize the appropriate pilot light.
- Convert the individual thermocouple data words to BCD and send the data to the respective LED displays.

Program Listing

The first six rungs of this program send the correct channel setup information to the NT4 module based on the position of the two selector switches.

Rung 2.0

If the degrees selector switch is turned to the Fahrenheit position, set up all four channels to read in degrees Fahrenheit. The default for channel 0 is to read the ambient temperature thermocouple.

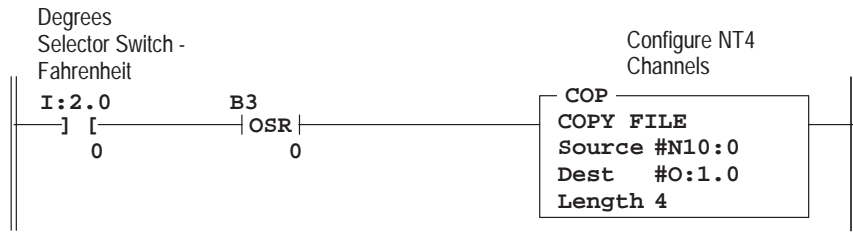

Rung 2.1

If the ambient/cabinet selector switch is turned to the ambient position and the degrees selector switch is in the Fahrenheit position, configure channel 0 to read the ambient temperature thermocouple in degrees Fahrenheit.

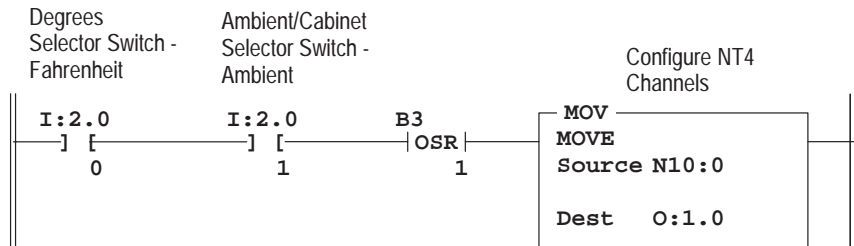

Rung 2.2

If the ambient/cabinet selector switch is turned to the cabinet position and the degrees selector switch is in the Fahrenheit position, configure channel 0 to read the CJC sensor on the NT4 module in degrees Fahrenheit.

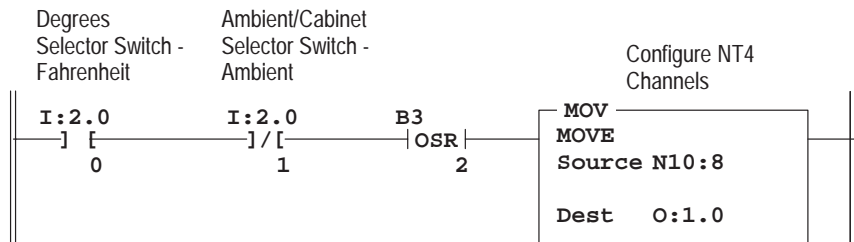

Rung 2.3

If the degrees selector switch is turned to the Celsius position, set up all four channels to read in degrees Celsius. The default for channel 0 is to read the ambient temperature thermocouple.

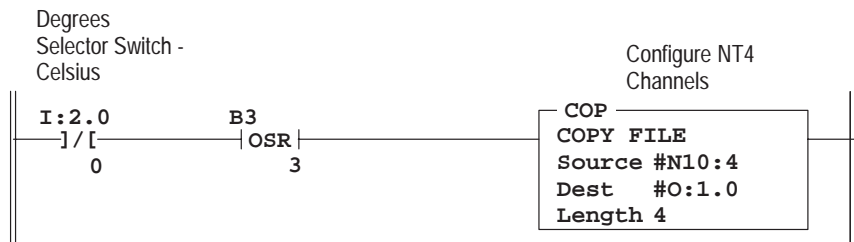

Rung 2.4

If the ambient/cabinet selector switch is turned to the ambient position and the degrees selector switch is in the Celsius position, configure channel 0 to read the ambient temperature thermocouple in degrees Celsius.

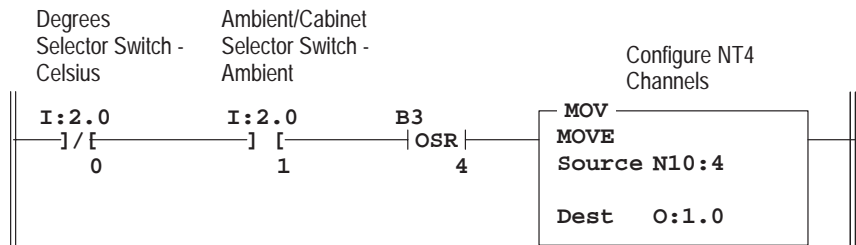

Rung 2.5

If the ambient/cabinet selector switch is turned to the cabinet position and the degrees selector switch is in the Celsius position, configure channel 0 to read the CJC sensor on the NT4 module in degrees Celsius.

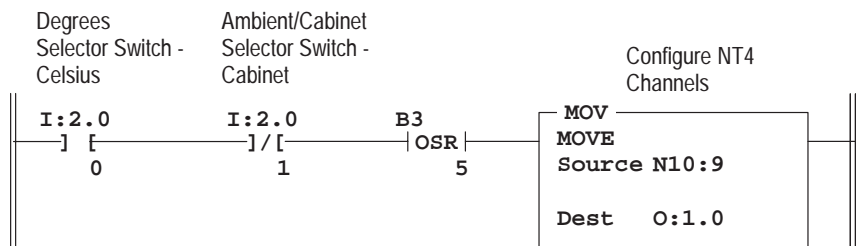

Rung 2.6

If channel 0 is set up for reading the ambient thermocouple, energize the ambient pilot light on the annunciator panel.

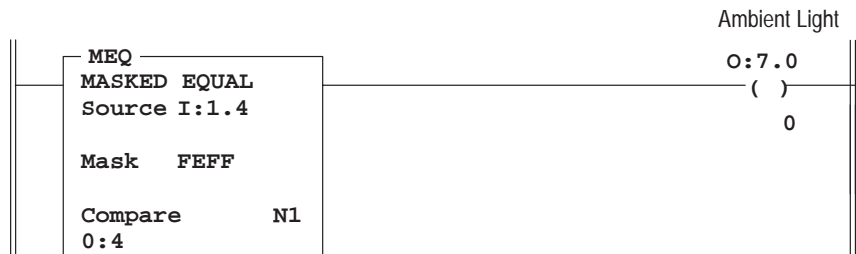

Rung 2.7

If channel 0 is set up for reading the CJC sensor on the NT4 module, energize the cabinet pilot light on the annunciator panel.

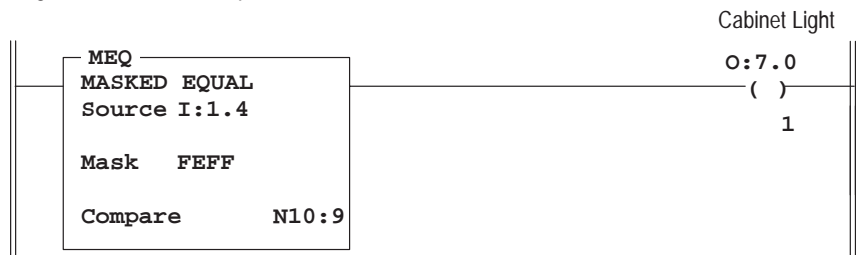

Rung 2.8

Convert the NT4 data words to BCD format and send to the LED displays.

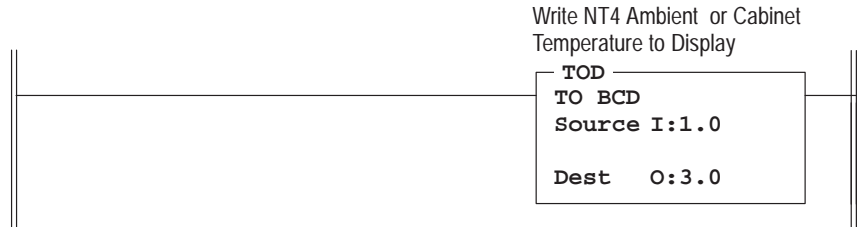

Rung 2.9

Write NT4 Bath Temperature to Display



Rung 2.10

Write NT4 Steam Temperature to Display



Rung 2.11

Write NT4 Chilled Temperature to Display



Rung 2.12

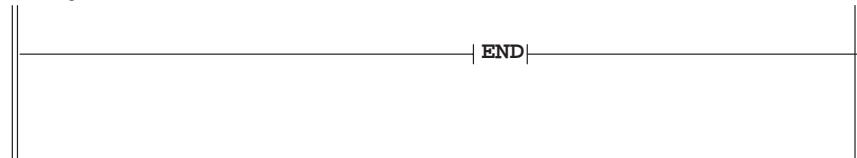

Data Table

| address | 15 | data | 0 | address | 15 | data | 0 |
|---------|------|-----------|------|---------|------|-----------|------|
| N10:0 | 0000 | 1101 0000 | 0010 | N10:5 | 0000 | 1100 0000 | 0000 |
| N10:1 | 0000 | 1101 0000 | 0000 | N10:6 | 0000 | 1100 0000 | 0001 |
| N10:2 | 0000 | 1101 0000 | 0001 | N10:7 | 0000 | 1100 0000 | 0000 |
| N10:3 | 0000 | 1101 0000 | 0000 | N10:8 | 0000 | 1101 0000 | 1111 |
| N10:4 | 0000 | 1100 0000 | 0010 | N10:9 | 0000 | 1100 0000 | 1111 |

Specifications

This appendix lists the specifications for the 1746-NT4 Thermocouple/mV Input Module.

Electrical Specifications

| | |
|---|--|
| Backplane Current Consumption | 60 mA at 5V dc 40 mA at 24V dc |
| Backplane Power Consumption | 0.8W maximum (0.3W @ 5V dc, 0.5W @ 24V dc) |
| Number of Channels | 4 (backplane isolated) |
| I/O Chassis Location | Any I/O module slot except slot 0 |
| A/D Conversion Method | Sigma-Delta Modulation |
| Input Filtering | Low pass digital filter with programmable notch (filter) frequencies |
| Normal Mode Rejection (between [+] input and [-] input) | Greater than 100 dB at 50 Hz (10 Hz, 50 Hz filter frequencies) Greater than 100 dB at 60 Hz (10 Hz, 60 Hz filter frequencies) |
| Common Mode Rejection (between inputs and chassis ground) | Greater than 150 dB at 50 Hz (10 Hz, 50 Hz filter frequencies) Greater than 150 dB at 60 Hz (10 Hz, 60 Hz filter frequencies) |
| Input Filter Cut-Off Frequencies | 2.62 Hz at 10 Hz filter frequency 13.1 Hz at 50 Hz filter frequency 15.72 Hz at 60 Hz filter frequency 65.5 Hz at 250 Hz filter frequency |
| Calibration | Module autocalibrates at power-up and whenever a channel is enabled. |
| Isolation | 500V dc continuous between inputs and chassis ground, and between inputs and backplane. |
| Maximum Channel-to-Channel Common-Mode Separation | Series B or later: 2V maximum between any two channels Series A: 0V separation |

Physical Specifications

| | |
|--|--|
| LED Indicators | 5, green status indicators, one for each of 4 channels and one for module status |
| Module ID Code | 3510 |
| Recommended Cable: for thermocouple inputs . . . for mV inputs . . . | Appropriate shielded twisted pair thermocouple extension wire ^① Belden #8761 or equivalent |
| Maximum Wire Size | Two 14 AWG wires per terminal |
| Maximum Cable Impedance | 25 ohms maximum loop impedance, for <1LSB error |
| Terminal Strip | Removable, Allen-Bradley spare part Catalog Number 1746-RT32 |

^① Refer to the thermocouple manufacturer for the correct extension wire.

Environmental Specifications

| | |
|--------------------------------------|---|
| Operating Temperature | 0°C to 60°C (32°F to 140°F) |
| Storage Temperature | -40°C to +85°C (-40°F to +185°F) |
| Relative Humidity | 5% to 95% (without condensation) |
| Certification | UL listed CSA approved CE compliant for all applicable directives when product or packaging is marked |
| Hazardous Environment Classification | Class I Division 2 Hazardous Environment |

Input Specifications

| | | | |
|--|---|------------------------------------|--------------------|
| Type of Input (Selectable) | Thermocouple Type J | -210°C to 760°C | (-346°F to 1400°F) |
| | Thermocouple Type K | -270°C to 1370°C | (-454°F to 2498°F) |
| | Thermocouple Type T | -270°C to 400°C | (-454°F to 752°F) |
| | Thermocouple Type E | -270°C to 1000°C | (-454°F to 1832°F) |
| | Thermocouple Type R | 0°C to 1768°C | (32°F to 3214°F) |
| | Thermocouple Type S | 0°C to 1768°C | (32°F to 3214°F) |
| | Thermocouple Type B | 300°C to 1820°C | (572°F to 3308°F) |
| | Thermocouple Type N (14 AWG) | 0°C to 1300°C | (32°F to 2372°F) |
| | | Millivolt (-50 mV dc to +50 mV dc) | |
| | Millivolt (-100 mV dc to +100 mV dc) | | |
| Thermocouple Linearization | IPTS-68 standard, NBS MN-125, NBS MN-161 | | |
| Cold Junction Compensation | Accuracy $\pm 1.5^\circ\text{C}$, 0°C to 85°C (32°F to 185°F) | | |
| Input Impedance | Greater than 10M Ω | | |
| Temperature Scale (Selectable) | °C or °F and 0.1°C or 0.1°F | | |
| DC Millivolt Scale (Selectable) | 0.1 mV or 0.01 mV | | |
| Open Circuit Detection Leakage Current | 12 nA maximum | | |
| Open Circuit Detection Method | Upscale | | |
| Time to Detect Open Circuit | 500 msec or 1 module update time, whichever is greater | | |
| Input Step Response | See channel step response, page 4-6. | | |
| Input Resolution | See Input Resolution Graphs on following pages. These graphs show the smallest measurable unit based on the combined hardware and software tolerances. | | |
| Display Resolution | See Channel Data Word Resolution table on page 5-7. | | |
| Overall Module Accuracy @ 25°C (77°F) | See Module Accuracy Table, page A-3 | | |
| Overall Module Accuracy (0°C to 60°C, 32°F to 140°F) | See Module Accuracy Table, page A-3 | | |
| Overall Module Drift | See Module Accuracy Table, page A-3 | | |
| Module Update Time | See Chapter 4, Update Time, page 4-7 | | |
| Channel Turn-On Time, Reconfiguration Time | Requires up to one module update time plus one of the following: <ul style="list-style-type: none"> • 250 Hz Filter = 82 milliseconds • 60 Hz Filter = 196 milliseconds • 50 Hz Filter = 226 milliseconds • 10 Hz Filter = 946 milliseconds | | |
| Channel Turn-Off Time | Requires up to one module update time (refer to page 4-7) | | |

1746-NT4 Module Accuracy

| Input Type | With Autocalibration ^① | | Without Autocalibration ^① |
|------------|-----------------------------------|-------------------------|--------------------------------------|
| | Maximum Error @ 25°C | Maximum Error @ 77°F | Temperature Drift (0°C-60°C) |
| J | ±1.06°C | ±1.91°F | ±0.0193°C/°C, °F/°F |
| K | ±1.72°C | ±3.10°F | ±0.0328°C/°C, °F/°F |
| T | ±1.43°C | ±2.57°F | ±0.0202°C/°C, °F/°F |
| E | ±0.72°C | ±1.3°F | ±0.0190°C/°C, °F/°F |
| S | ±3.61°C | ±6.5°F | ±0.0530°C/°C, °F/°F |
| R | ±3.59°C | ±6.46°F | ±0.0530°C/°C, °F/°F |
| B | ±3.12°C | ±5.62°F | ±0.0457°C/°C, °F/°F |
| N | ±1.39°C | ±2.5°F | ±0.0260°C/°C, °F/°F |
| ±50 mV | ±50 μV | ±50 μV | ±1.0 μV/°C, ±1.8 μV/°F |
| ±100 mV | ±50 μV | ±50 μV | ±1.5 μV/°C, ±2.7 μV/°F |

① Assumes the module terminal block temperature is stable.

Allen-Bradley Drives

Input Resolution per Thermocouple Type at Each Filter Frequency

| Resolution | $\frac{(^{\circ}\text{C})}{(^{\circ}\text{F})}$ | |
|-----------------------|---|-----------------------------|
| | 250 Hz | 50/60 Hz |
| $\frac{12.80}{23.04}$ | $\frac{1.60}{2.88}$ | 10 Hz $\frac{0.8}{1.44}$ |
| $\frac{9.60}{17.28}$ | $\frac{1.20}{2.16}$ | $\frac{0.6}{1.08}$ |
| $\frac{6.40}{11.52}$ | $\frac{0.80}{1.44}$ | $\frac{0.4}{0.72}$ |
| $\frac{3.20}{5.76}$ | $\frac{0.40}{0.72}$ | $\frac{0.2}{0.36}$ |

Type E Thermocouple

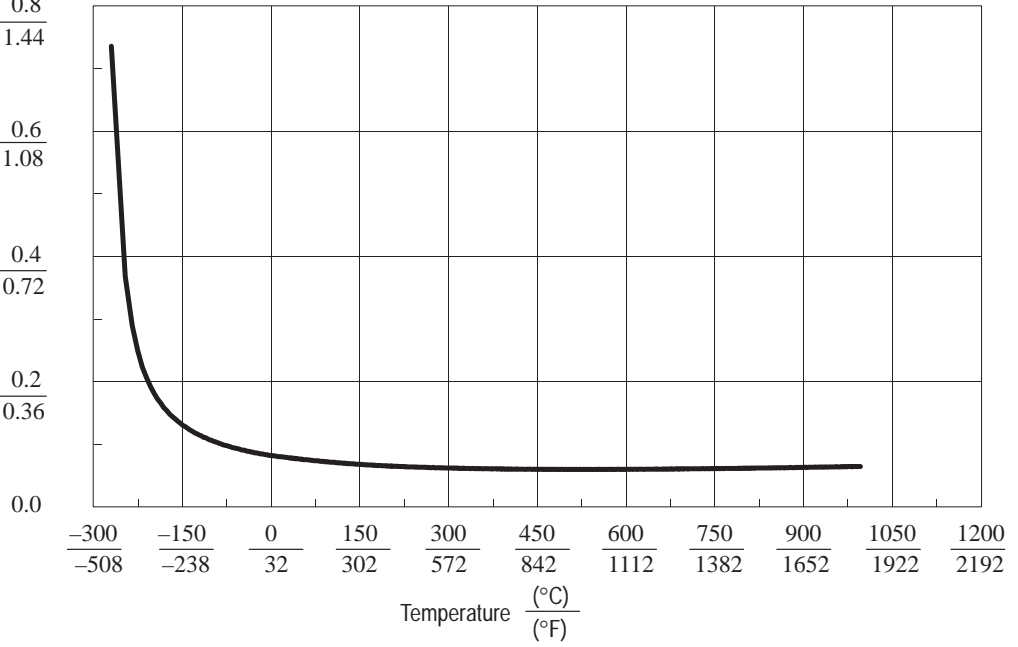

| Resolution | $\frac{(^{\circ}\text{C})}{(^{\circ}\text{F})}$ | |
|---------------------|---|------------------------------|
| | 250 Hz | 50/60 Hz |
| $\frac{3.20}{5.76}$ | $\frac{0.40}{0.72}$ | 10 Hz $\frac{0.20}{0.36}$ |
| $\frac{2.40}{4.32}$ | $\frac{0.30}{0.54}$ | $\frac{0.15}{0.27}$ |
| $\frac{1.60}{2.88}$ | $\frac{0.20}{0.36}$ | $\frac{0.10}{0.18}$ |
| $\frac{0.80}{1.44}$ | $\frac{0.10}{0.18}$ | $\frac{0.05}{0.09}$ |

Type J Thermocouple

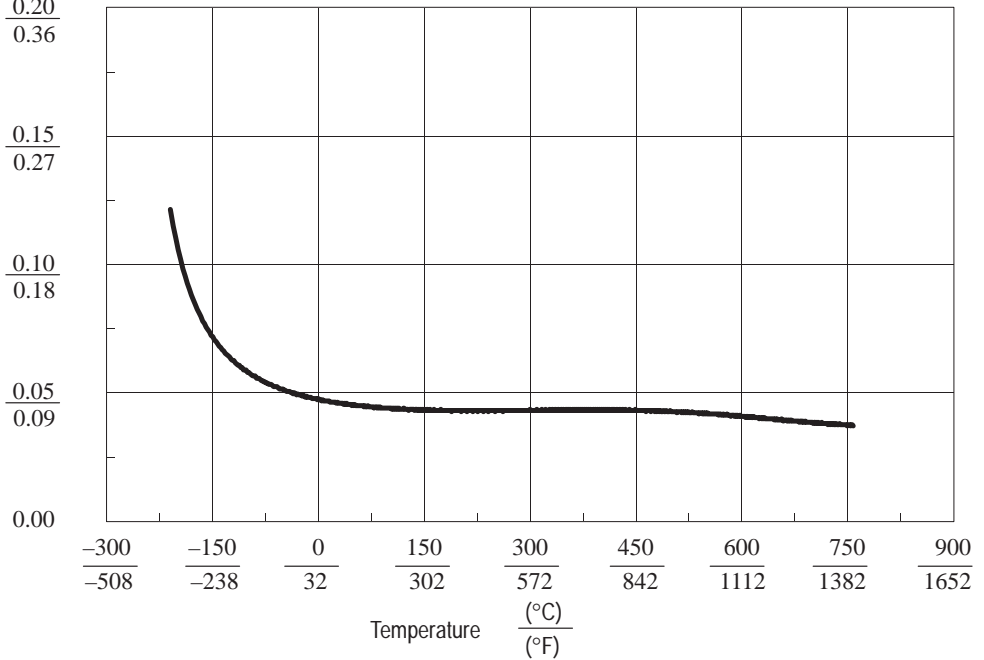

| Resolution | | $\frac{(\text{°C})}{(\text{°F})}$ |
|-----------------------|---------------------|-----------------------------------|
| 250 Hz | 50/60 Hz | 10 Hz |
| $\frac{12.80}{23.04}$ | $\frac{1.60}{2.88}$ | $\frac{0.8}{1.44}$ |
| $\frac{9.60}{17.28}$ | $\frac{1.20}{2.16}$ | $\frac{0.6}{1.08}$ |
| $\frac{6.40}{11.52}$ | $\frac{0.80}{1.44}$ | $\frac{0.4}{0.72}$ |
| $\frac{3.20}{5.76}$ | $\frac{0.40}{0.72}$ | $\frac{0.2}{0.36}$ |

Type K Thermocouple

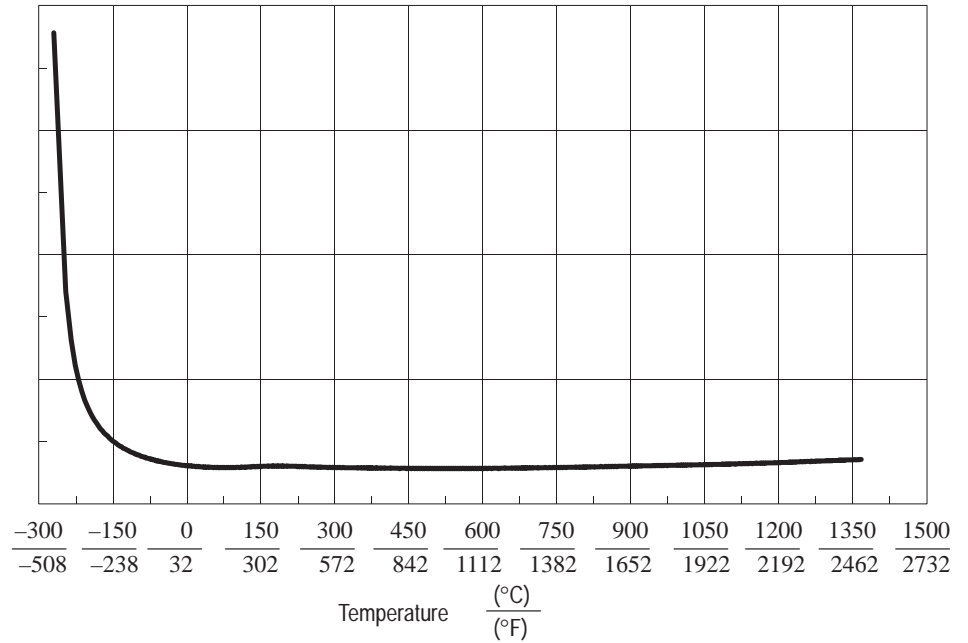

| Resolution | | $\frac{(\text{°C})}{(\text{°F})}$ |
|---------------------|---------------------|-----------------------------------|
| 250 Hz | 50/60 Hz | 10 Hz |
| $\frac{1.60}{2.88}$ | $\frac{0.20}{0.36}$ | $\frac{0.10}{0.18}$ |
| $\frac{1.28}{2.30}$ | $\frac{0.16}{0.29}$ | $\frac{0.08}{0.14}$ |
| $\frac{0.96}{1.73}$ | $\frac{0.12}{0.22}$ | $\frac{0.06}{0.11}$ |
| $\frac{0.64}{1.15}$ | $\frac{0.08}{0.14}$ | $\frac{0.04}{0.07}$ |
| $\frac{0.32}{0.58}$ | $\frac{0.04}{0.07}$ | $\frac{0.02}{0.04}$ |

Type N Thermocouple

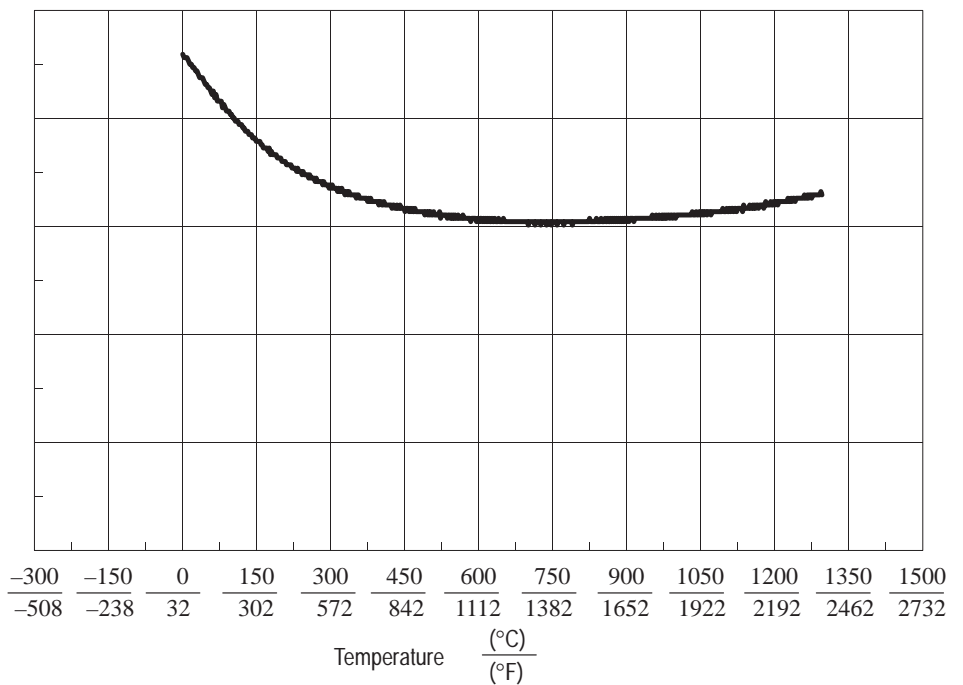

Resolution $\frac{(^{\circ}\text{C})}{(^{\circ}\text{F})}$

| | | |
|----------------------|---------------------|--------------------|
| 250 Hz | 50/60 Hz | 10 Hz |
| $\frac{6.79}{12.22}$ | $\frac{1.20}{2.16}$ | $\frac{0.6}{1.08}$ |

Type R Thermocouple

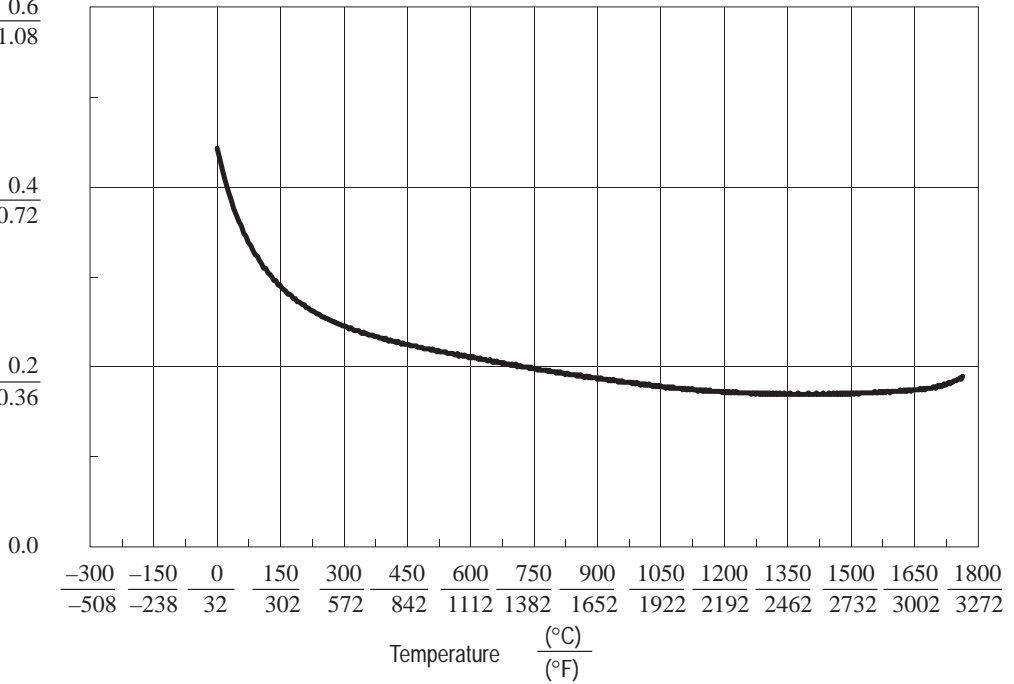

Resolution $\frac{(^{\circ}\text{C})}{(^{\circ}\text{F})}$

| | | |
|----------------------|---------------------|--------------------|
| 250 Hz | 50/60 Hz | 10 Hz |
| $\frac{6.79}{12.22}$ | $\frac{1.20}{2.16}$ | $\frac{0.6}{1.08}$ |

Type S Thermocouple

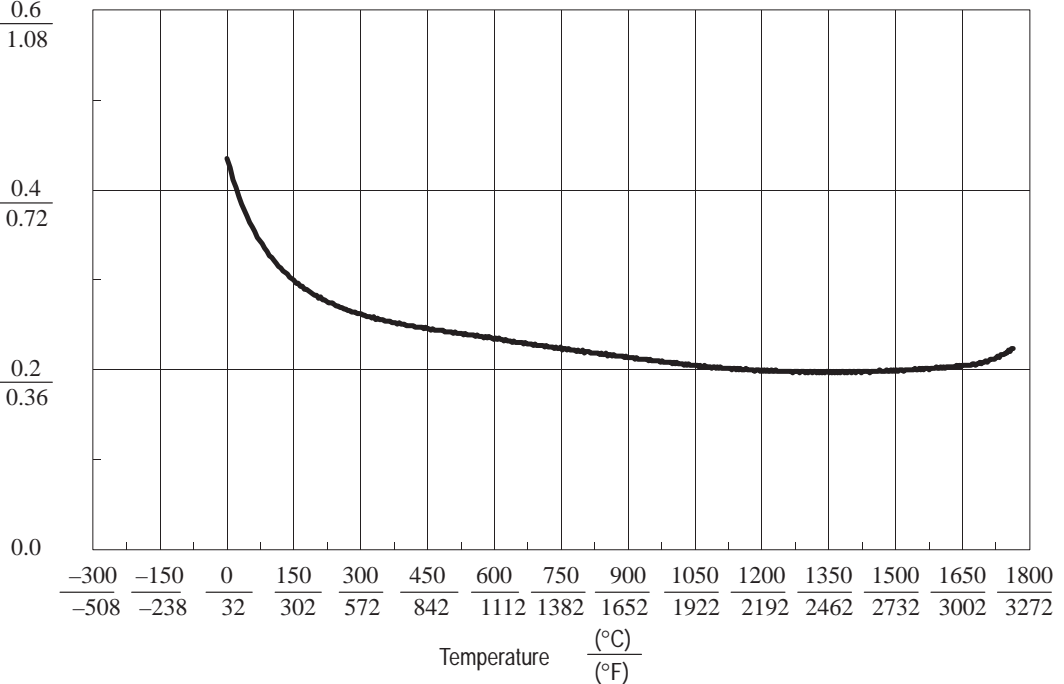

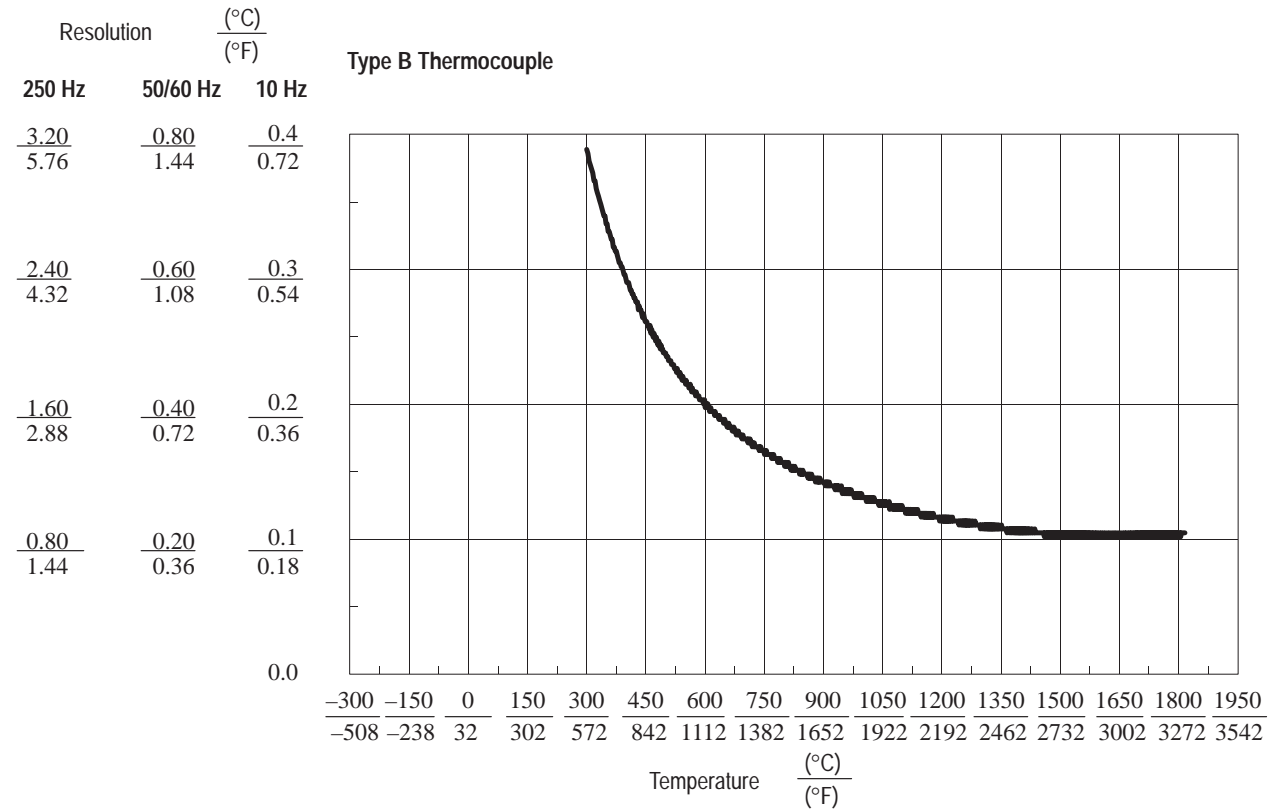
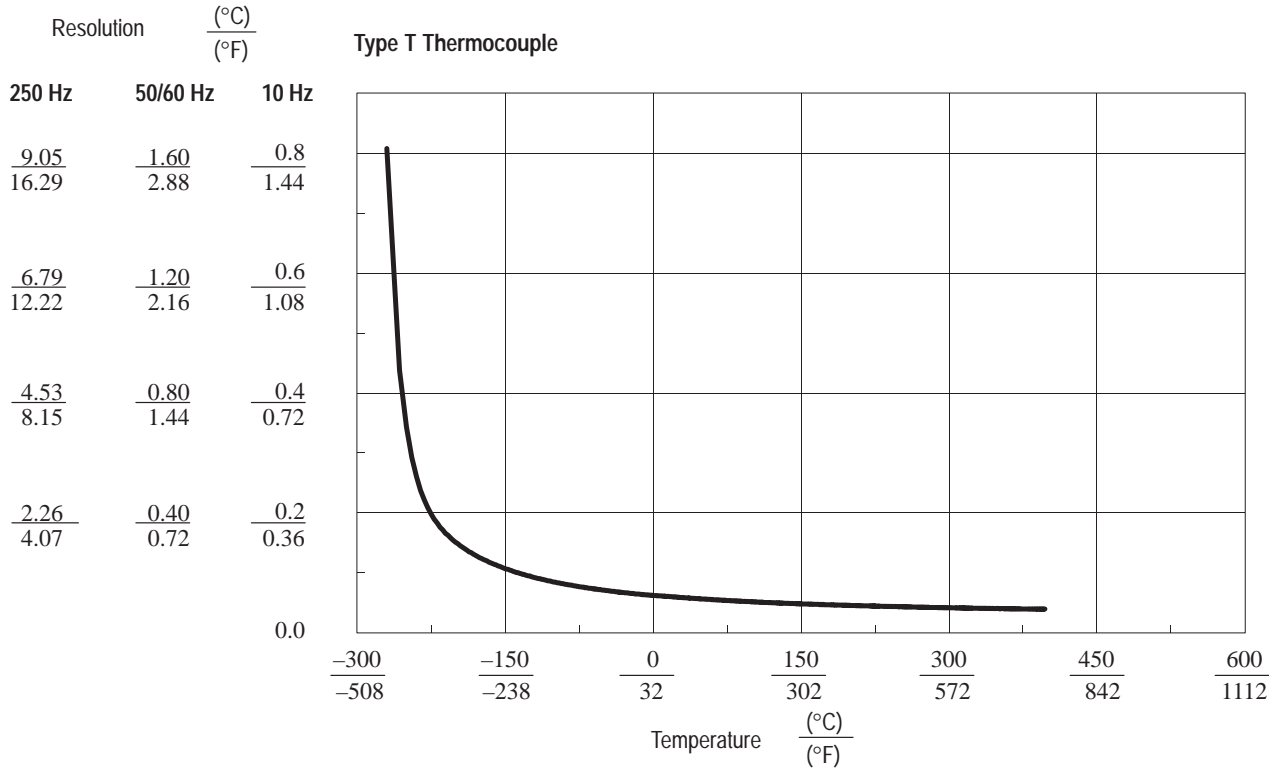

NT4 Configuration Worksheet

The following configuration procedure and worksheet are provided to help you configure each of the channels on your thermocouple module.

Channel Configuration Procedure

The channel configuration word consists of bit fields, the settings of which determine how the channel will operate. This procedure looks at each bit field separately and helps you configure a channel for operation. Refer to the chart on page 5–3 and the detailed configuration information in chapter 5 as needed to complete the procedures in this appendix. Or you may prefer to use the summary worksheet on page B–3.

1. Determine the input device type for a channel and enter its respective 4-digit binary code in bit field 0-3 of the channel configuration word.

| | | | | |
|-----------------|-------------------|----------|----------|------------------------|
| Bits 0-3 | Input Type Select | 0000 = J | 0100 = R | 1000 = ±50mV |
| | | 0001 = K | 0101 = S | 1001 = ±100mV |
| | | 0010 = T | 0110 = B | |
| | | 0011 = E | 0111 = N | 1111 = CJC temperature |
| | | | | |

2. Select a data format for the data word value. Your selection determines how the analog input value registered by the analog sensor will be expressed in the data word. Enter your 2-digit binary code in bit field 4-5 of the channel configuration word.

| | | |
|---------------------|--------------------|---|
| Bits 4 and 5 | Data Format Select | 00 = engineering units, x1 (0.1°/step, 0.01mV/step) |
| | | 01 = engineering units, x10 (1°/step, 0.1mV/step) |
| | | 10 = scaled-for-PID (0 to 16383) |
| | | 11 = proportional counts (-32768 to +32767) |

3. Determine the desired state for the channel data word if an open circuit condition is detected for that channel. Enter the 2-digit binary code in bit field 6-7 of the channel configuration word.

| | | | | |
|---------------------|---------------------|-----------|--------------|----------------|
| Bits 6 and 7 | Open Circuit Select | 00 = zero | 01 = upscale | 10 = downscale |
| | | | | |

4. If the channel is configured for thermocouple inputs or the CJC sensor, determine if you want the channel data word to read in degrees Fahrenheit or degrees Celsius and enter a one or a zero in bit 8 of the configuration word. If the channel is configured for a mV analog sensor, enter a zero in bit 8.

| | | | |
|--------------|--------------------------|---------------------|------------------------|
| Bit 8 | Temperature Units Select | 0 = degrees Celsius | 1 = degrees Fahrenheit |
| | | | |

5. Determine the desired input filter for the channel and enter the 2-digit binary code in bit field 9-10 of the channel configuration word. A smaller filter frequency increases the channel update time, but also increases the noise rejection and channel resolution. A larger filter frequency decreases the noise rejection, but also decreases the channel update time and channel resolution.

| | | | | | |
|----------------------|-------------------------|------------|------------|------------|-------------|
| Bits 9 and 10 | Filter Frequency Select | 00 = 10 Hz | 01 = 50 Hz | 10 = 60 Hz | 11 = 250 Hz |
|----------------------|-------------------------|------------|------------|------------|-------------|

6. If the channel will be used in your system it must be enabled. Place a one in bit 11 if the channel is to be enabled. Place a zero in bit 11 if the channel is to be disabled.

| | | | |
|---------------|----------------|----------------------|---------------------|
| Bit 11 | Channel Enable | 0 = channel disabled | 1 = channel enabled |
|---------------|----------------|----------------------|---------------------|

7. Ensure that bits 12-15 contain zeros, and then enter all the bit setting selected in previous steps to complete the configuration word.

| | | |
|-------------------|----------|---------------------------------|
| Bits 12-15 | Not Used | 0000 = always make this setting |
|-------------------|----------|---------------------------------|

8. Build the channel configuration word for every channel that is being used on each thermocouple/mV module repeating the procedures given in steps 1-7.
9. Enter the completed configuration words for each module into the summary worksheet on the following page.
10. Following the steps outlined in chapter 2, Quick Start, or in chapter 6, Ladder Programming Examples, enter this configuration data into your ladder program and copy it to the thermocouple module.

Channel Configuration Summary Worksheet

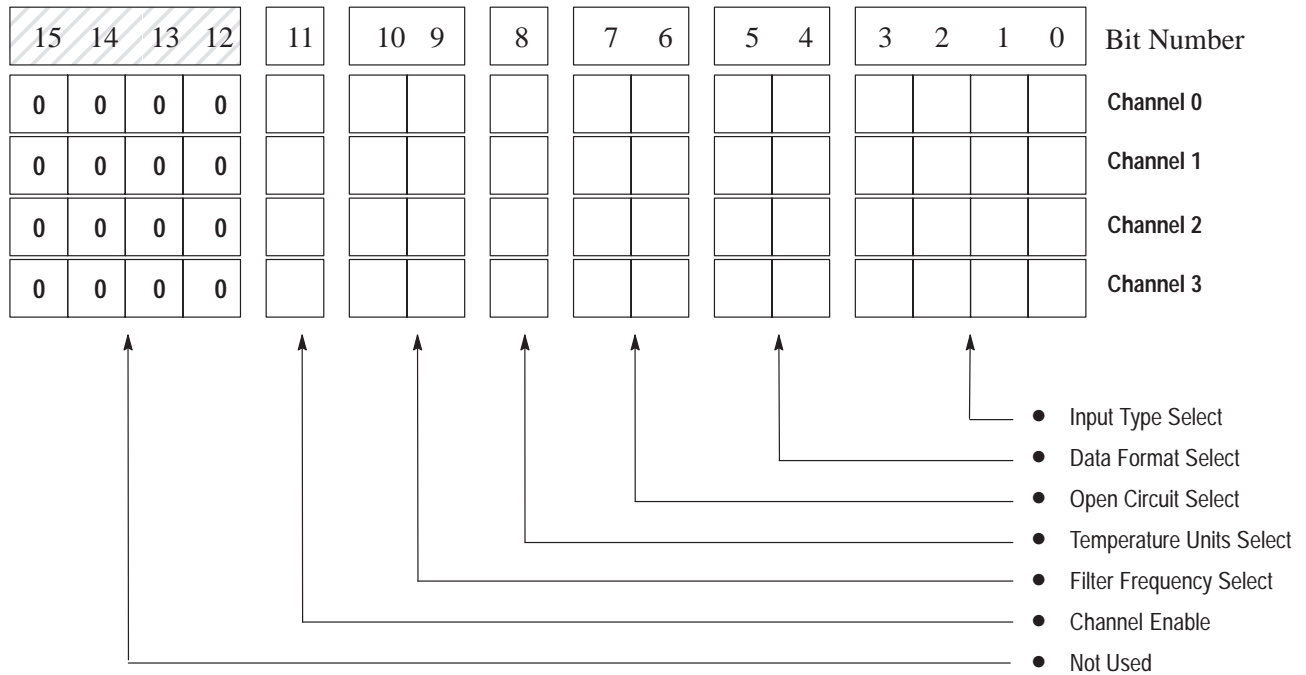

Bit Definitions:

| | | | | |
|----------------------|--------------------------|--|--|---|
| Bits 0-3 | Input Type Select | 0000 = J 0001 = K 0010 = T 0011 = E | 0100 = R 0101 = S 0110 = B 0111 = N | 1000 = ±50mV 1001 = ±100mV 1111 = CJC temperature |
| Bits 4 and 5 | Data Format Select | 00 = engineering units, x1 (0.1°/step, 0.01mV/step) 01 = engineering units, x10 (1°/step, 0.1mV/step) | | 10 = scaled-for-PID (0 to 16383) 11 = proportional counts (-32768 to +32767) |
| Bits 6 and 7 | Open Circuit Select | 00 = zero | 01 = upscale | 10 = downscale |
| Bit 8 | Temperature Units Select | 0 = degrees Celsius | 1 = degrees Fahrenheit | |
| Bits 9 and 10 | Filter Frequency Select | 00 = 10 Hz | 01 = 50 Hz | 10 = 60 Hz 11 = 250 Hz |
| Bit 11 | Channel Enable | 0 = channel disabled 1 = channel enabled | | |
| Bits 12-15 | Not Used | 0000 = always make this setting | | |

Thermocouple Restrictions

Following are some restrictions extracted from NBS Monograph 125 (IPTS-68) issued March 1974 on thermocouples J, K, T, E, R, and S.

J Type Thermocouple

(Iron vs. Copper-Nickel <Constantan[®]>)

The J thermocouple “is the least suitable for accurate thermometry because there are significant nonlinear deviations in the thermoelectric output from different manufacturers. ... The total and specific types of impurities that occur in commercial iron change with time, location of primary ores, and methods of smelting.”

“Type J thermocouples are recommended by the ASTM [1970] for use in the temperature range from 0 to 760C in vacuum, oxidizing, reducing or inert atmospheres. If used for extended times above 500C, heavy gauge wires are recommended because the oxidation rate is rapid at elevated temperatures.”

“They should not be used in sulfurous atmospheres above 500C. Because of potential rusting and embrittlement, they are not recommended for subzero temperatures. They should not be cycled above 760C even for a short time if accurate reading below 760C are desired at a later time.”

“The negative thermoelement, a copper-nickel alloy, is subject to substantial composition changes under thermal neutron irradiation, since copper is converted to nickel and zinc.”

“Commercial iron undergoes a magnetic transformation near 769C and <an alpha - gamma> crystal transformation near 910C. Both of these transformation, especially the latter, seriously affect the thermoelectric properties of iron, and therefore, the Type J thermocouples. ... If Type J thermocouples are taken to high temperatures, especially above 900C, they will lose accuracy of their calibration when they are recycled to lower temperatures.”

“ASTM Standard E230-72 in the Annual Book of ASTM Standards [1972] specifies that the standard limits of error for Type J commercial thermocouples be $\pm 2.2\text{C}$ between 0 and 277C and $\pm 3/4$ percent between 277 and 760C. Limits of error are not specified for Type J thermocouples below 0C or above 760C. Type J thermocouples can also be supplied to meet special limits of error, which are equal to one half the limits given above. The recommended upper temperature limit for protected thermocouples, 760C, applies to AWG 8 (3.3mm) wire. For smaller wires the recommended upper temperature decreases to 593C for AWG 14 (1.6mm), and 371C for AWG 24 or 28 (0.5 or 0.3mm).”

^① It should be noted that the Constantan element of Type J thermoelements is NOT interchangeable with the Constantan element of Types T or N due to the different ration of copper and nickel in each.

K Type Thermocouple

(Nickel-Chromium vs. Nickel-Aluminum)

“This type is more resistant to oxidation at elevated temperatures than the Types E, J or T thermocouples and consequently it finds wide application at temperatures above 500C.”

“Type K thermocouples may be used at “liquid hydrogen” temperatures. However, their Seebeck coefficient (about 4uV/K at 20K) is only about one-half of that of E thermocouples. Furthermore, the thermoelectric homogeneity of KN thermoelements is generally not quite as good as that of EN thermoelements. Both the KP and the KN thermoelements do have a relatively low thermal conductivity and good resistance to corrosion in moist atmospheres at low temperatures.”

“Type K thermocouples are recommended by the ASTM [1970] for continuous use at temperatures within the range -250 to 1260C in oxidizing or inert atmospheres. Both the KP and the KN thermoelements are subject to oxidation when used in air above about 850C, but even so, Type K thermocouples may be used at temperatures up to about 1350C for short periods with only small changes in calibration.”

“They should not be used in sulfurous, reducing, or alternately reducing and oxidizing atmospheres unless suitably protected with protecting tubes. They should not be used in vacuum (at high temperatures) for extended times because the Chromium in the positive thermoelement vaporizes out of solution and alters the calibration. They should also no be used in atmospheres that promote “green-rot” corrosion (those with low, but not negligible, oxygen content).”

“ASTM Standard E230-72 in the Annual Book of ASTM Standards [1972] specifies that the standard limits of error for Type K commercial thermocouples be $\pm 2.2C$ between 0 and 277C and $\pm 3/4$ percent between 277 and 1260C/ Limits of error are not specified for the Type K thermocouples below 0C. Type K thermocouples can also be supplied to meet special limits of error, which are equal to one half the standard limits of error given above. The recommended upper temperature limit for protected Type K thermocouples, 1260C, applies for AWG 8 (3.3mm) wire. For smaller wires it decreases to 1093C for AWG 14 (1.6mm), 982C for AWG 20 (0.8mm), and 871C for AWG 24 or 28 (0.5 or 0.3mm).”

T Type Thermocouple

(Copper vs. Copper-Nickel <Constantan[®]>)

“The homogeneity of most Type TP and TN (or EN) thermoelements is reasonably good. However, the Seebeck coefficient of Type T thermocouples is moderately small at subzero temperatures (about 5.6uV/K at 20K), being roughly two-thirds that of Type E thermocouples. This, together with the high thermal conductivity of Type TP thermoelements, is the major reason why Type T thermocouples are less suitable for use in the subzero range than Type E thermocouples.”

“Type T thermocouples are recommended by the ASTM [1970] for use in the temperature range -184 to 371C in vacuum or in oxidizing, reducing or inert atmospheres. The recommended upper temperature limit for continuous service of protected Type T thermocouples is set at 371C for AWG 14 (1.6mm) thermoelements, since Type TP thermoelements oxidize rapidly above this temperature. However, the thermoelectric properties of Type TP thermoelements are apparently not grossly affected by oxidation since Roeser and Dahl [1938] observed negligible changes in the thermoelectric voltage of Nos. 12, 18, and 22 AWG Type TP thermoelements after heating for 30 hours in air at 500C. At this temperature the Type TN thermoelements have good resistance to oxidation and exhibit only small changes in thermal emf with long exposure in air, as shown by the studies of Dahl [1941].” ... “Operation of Type T thermocouples in hydrogen atmospheres at temperatures above about 370C is not recommended since severe embrittlement of the Type TP thermoelements may occur.”

“Type T thermoelements are not well suited for use in nuclear environments, since both thermoelements are subject to significant changes in composition under thermal neutron irradiation. The copper in the thermoelement is converted to nickel and zinc.”

Allen-Bradley Drives

“Because of the high thermal conductivity of Type TP thermoelements, special care should be exercised in the use of the thermocouples to insure that both the measuring and reference junctions assume the desired temperatures.”

ASTM Standard E230-72 in the Annual Book of ASTM Standards [1972] specifies that the standard limits of error for Type T commercial thermocouples be ± 2 percent between -101 and -59C, ± 0.8 C between -59 and 93C and $\pm 3/4$ percent between 93 and 371C. Type T thermocouples can also be supplied to meet special limits of error, which are equal to one half the standard limits of error given above (plus a limit of error of ± 1 percent is specified between -184 and -59C). The recommended upper temperature limit for protected Type T thermocouples, 371C, applies to AWG 14 (1.6mm) wire. For smaller wires it decreases to 260C for AWG 20 (0.8mm) and 240C for AWG 24 or 28 (0.5 or 0.3mm).”

^① It should be noted that the Constantan element of Type J thermoelements is NOT interchangeable with the Constantan element of Types T or N due to the different ration of copper and nickel in each.

E Type Thermocouple

(Nickel-Chromium vs. Copper-Nickel <Constantan^①>)

“Type E thermocouples are recommended by the ASTM Manual [1970] for use in the temperature range from -250 to 871C in oxidizing or inert atmospheres. The negative thermoelement is subject to deterioration above about 871C, but the thermocouple may be used up to 1000C for short periods.”

“The ASTM Manual [1970] indicates the following restrictions ... at high temperatures. They should not be used in sulfurous, reducing or alternately reducing and oxidizing atmospheres unless suitable protected with protecting tubes. They should not be used in vacuum (at high temperatures) for extended times, because the Chromium in the positive thermoelement vaporizes out of solution and alters the calibration. They should also not be used in atmospheres that promote “green-rot” corrosion (those with low, but not negligible, oxygen content).”

“The negative thermoelement, a copper-nickel alloy, is subject to composition changes under thermal neutron irradiation since the copper is converted to nickel and zinc.”

“ASTM Standard E230-72 in the Annual Book of ASTM Standards [1972] specifies that the standard limits of error for the Type E commercial thermocouples be $\pm 1.7C$ between 0 and 316C and $\pm 1/2$ percent between 316 and 871C. Limits of error are not specified for Type E thermocouples below 0C. Type E thermocouples can also be supplied to meet special limits of error, which are less than the standard limits of error given above: $\pm 1.25C$ between 0 and 316C and $\pm 3/8$ percent between 316 and 871C, applies to AWG 8 (3.3mm) wire. For smaller wires the recommended upper temperature decreases to 649C for AWG 14 (1.6mm), 538C for AWG 20 (0.8mm) and 427C for AWG 24 or 28 (0.5 or 0.3mm).”

^① It should be noted that the Constantan element of Type J thermoelements is NOT interchangeable with the Constantan element of Types T or N due to the different ration of copper and nickel in each.

S and R Type Thermocouples

S (Platinum-10% Rhodium vs. Platinum) R (Platinum-13% Rhodium vs. Platinum)

“The ASTM manual STP 470 [1970] indicates the following restrictions on the use of S {and R} type thermocouples at high temperatures: They should not be used in reducing atmospheres, nor in those containing metallic vapor (such as lead or zinc), nonmetallic vapors (such as arsenic, phosphorous or sulfur) or easily reduced oxides, unless suitable protected with nonmetallic protecting tubes. They should never be inserted directly into a metallic primary tube.”

“The positive thermoelement, platinum-10% rhodium {13% rhodium for R}, is unstable in a thermal neutron flux because the rhodium converts to palladium. The negative thermoelement, pure platinum, is relatively stable to neutron transmutation. However, fast neutron bombardment will cause physical damage, which will change the thermoelectric voltage unless it is annealed out.”

“The thermoelectric voltages of platinum based thermocouples are sensitive to their heat treatments. In particular, quenching from high temperatures should be avoided.”

“ASTM Standard E230-72 in the Annual Book of ASTM Standards [1972] specifies that the standard limits of error for Type S {and R} commercial thermocouples be $\pm 1.4C$ between 0 and 538C and $\pm 1/4$ percent between 538 and 1482C. Limits of error are not specified for Type S {or R} thermocouples below 0C. The recommended upper temperature limit for continuous use of protected thermocouples, 1482C, applies to AWG 24 (0.5mm) wire.”

Allen-Bradley Drives

Thermocouple Types

This appendix describes the types of thermocouples.

There are 3 types of thermocouple junctions:

- *Grounded Junction* - The measuring junction is physically connected to the protective metal sheath providing electrical continuity between junction and sheath.
- *Ungrounded Junction* - The measuring junction is electrically isolated from the protective metal sheath. (Also called Insulated Junction.)
- *Exposed Junction* - Does not have a protective metal sheath so the measuring junction is exposed.

The illustration that follows shows each of the 3 thermocouple types.

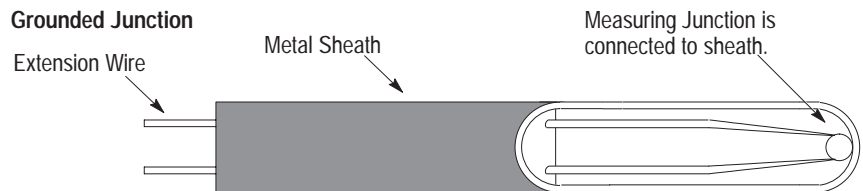

Glossary

The following terms and abbreviations are used throughout this manual. For definitions of terms not listed here refer to *Allen-Bradley's Industrial Automation Glossary*, Publication AG-7.1.

A/D - Refers to the analog to digital converter inherent to the NT4 thermocouple input module. The converter produces a digital value whose magnitude is proportional to the instantaneous magnitude of an analog input signal.

attenuation - The reduction in the magnitude of a signal as it passes through a system. The opposite of gain.

channel - Refers to one of four, small-signal analog input interfaces available on the module's terminal block. Each channel is configured for connection to a thermocouple or DC millivolt (mV) input device, and has its own diagnostic status word.

chassis - A hardware assembly that houses devices such as I/O modules, adapter modules, processor modules, and power supplies.

CJC - (Cold Junction Compensation) The means by which the module compensates for the offset voltage error introduced by the temperature at the junction between the thermocouple lead wire and the input terminal block (the cold junction).

common mode rejection ratio - The ratio of a device's differential voltage gain to common mode voltage gain. Expressed in dB, CMRR is a comparative measure of a device's ability to reject interference caused by a voltage common to its input terminals relative to ground. $CMRR=20 \text{ Log}_{10} (V1/V2)$

common mode voltage - A voltage that appears in common at both input terminals of a differential analog input with respect to ground.

configuration word - Contains the channel configuration information needed by the module to configure and operate each channel. Information is written to the configuration word through the logic supplied in your ladder program.

cut-off frequency - The frequency at which the input signal is attenuated 3dB by the digital filter. Frequency components of the input signal below the cut-off frequency are passed with under 3dB of attenuation.

dB - (decibel) A logarithmic measure of the ratio of two signal levels.

data word - A 16-bit integer that represents the value of the analog input channel. The channel data word is valid only when the channel is enabled and there are no channel errors. When the channel is disabled the channel data word is cleared (0).

digital filter - A low-pass noise filter incorporated into the A/D converter. The digital filter provides a very steep roll-off above its cut-off frequency, which provides high frequency noise rejection.

effective resolution - The number of bits in the channel data word that do not vary due to noise.

filter frequency - The user-selectable first-notch frequency for the A/D converter's digital filter. The digital filter provides high noise rejection at this frequency.

full scale error - (gain error) The difference in slope between the actual and ideal analog/thermocouple transfer functions.

full scale range - (FSR) The difference between the maximum and minimum specified analog/thermocouple input values.

gain drift - The change in full scale transition voltage measured over the operating temperature range of the module.

input data scaling - The data formats that you select to define the logical increments of the channel data word. These may be scaled-for-PID, or Engineering Units for millivolt, thermocouple, or CJC inputs, which are automatically scaled. They may also be proportional counts, which you must calculate to fit your application's temperature or voltage resolution.

local configuration - A control system where all the chassis are located within several feet of the processor, and chassis-to-chassis communication is via a 1746-C7 or 1746-C9 ribbon cable.

LSB - (Least Significant Bit) Refers to a data increment defined as the full scale range divided by the resolution. The bit that represents the smallest value within a string of bits.

multiplexer - An switching system that allows several input signals to share a common A/D converter.

normal mode rejection - (differential mode rejection) A logarithmic measure in dB, of a device's ability to reject noise signals between or among circuit signal conductors, but not between equipment grounding conductor or signal reference structure and the signal conductors.

remote configuration - A control system where the chassis can be located several thousand feet from the processor chassis. Chassis communication is via the 1747-SN Scanner and 1747-ASB Remote I/O Adapter.

resolution - The smallest detectable change in a measurement, typically expressed in engineering units (e.g. 0.15C) or as a number of bits. For example a 12-bit system has 4,096 possible output states. It can therefore measure 1 part in 4096.

sampling time - The time required by the A/D converter to sample an input channel.

status word - Contains status information about the channel's current configuration and operational state. You can use this information in your ladder program to determine whether the channel data word is valid.

step response time - Specific to the thermocouple module, this is the time required for the A/D input signal to reach 100% of its expected final value, given a large step change in the input signal.

update time - The time required for the module to sample and convert the input signals of all enabled input channels and make the resulting data values available to the SLC™ processor.

A

A/D, G-1
abbreviations, G-1
addressing, 4-2
 configuration word, 4-2
 addressing example, 4-2
 data word, 4-3
 addressing example, 4-3
 status word, 4-3
 addressing example, 4-3
alarms, 6-6, 6-7
Allen-Bradley, P-4
 contacting for assistance, P-4
analog common terminal, 3-7
attenuation, G-1
autocalibration, 6-7
 how to invoke, 6-7
 when to use it, 6-7

B

bit allocation, 5-1
 in configuration word, 5-3
 in status word, 5-12

C

cable tie slots, 1-3
calibration, 3-10
channel, G-1
channel configuration error, 7-4
 fault detection bit, 5-14
channel filter frequency, 4-4
 effects on noise filtering, 4-4
 effects on update time, 4-4
channel status bit, 5-13
chassis, G-1
CJC, 3-9, G-1
CMRR, G-1
cold junction compensation, 3-9, G-1
common mode rejection ratio, G-1
common mode voltage, G-1
compatibility, 1-5
 with SLC controllers, 1-5
 with thermocouple extension wire, 1-5
 with thermocouple sensors, 1-5

configuration word, 4-2, 5-1, G-1
 factory default setting, 5-1
 worksheet, B-3
configuring a channel, 5-1
 worksheet, B-3
connection diagram, 3-6
contacting Allen-Bradley for assistance, P-4
contents of manual, P-2
current draw, 3-1
cut-off frequency, 4-5, G-1

D

data word, 4-3, G-2
 resolution, 5-7
data word format, 5-4
 examining in status word, 5-13
 scaling ranges by input type, 5-7
 setting in configuration word, 5-4
dB, G-1
decibel, G-1
default setting of configuration word, 5-1
definition of terms, G-1
diagnostics
 at power-up, 7-1
 channel diagnostics, 7-2
differential mode rejection, G-2
 See also normal mode rejection
digital filter, G-2
disabling a channel, 5-10
door label, 1-3
dynamic channel configuration, 6-3

E

effective resolution, G-2
electrical noise, 3-3, 3-7
electrical specifications, A-1
electrostatic damage, 3-1
enabling a channel, 5-10
engineering units input, 5-4
environmental specifications, A-2
equipment required for installation, 2-1
errors, 7-4

- detecting channel-related errors, 7-4
 - configuration error, 7-4
 - open circuit, 7-4
 - over-range error, 7-5
 - under-range error, 7-5
 - detecting module-related errors, 7-5
 - conditions tested at power-up, 7-5
 - over-range error, 7-5
 - examples
 - basic application example, 8-1
 - how to address configuration word, 4-2
 - how to address data word, 4-3
 - how to address status word, 4-3
 - how to use PID instruction, 6-5
 - supplementary application example, 8-4
 - using alarms to indicate status, 6-6
 - verifying channel configuration changes, 6-4
 - exposed thermocouples, using multiple thermocouples, D-1
 - extension wire, 1-5
- F**
- filter frequency, G-2
 - examining in status word, 5-13
 - setting in configuration word, 5-9
 - FSR, G-2
 - full scale error, G-2
 - full scale range, G-2
- G**
- gain drift, G-2
 - gain error, G-2
 - See also* full scale error
 - getting started, 2-1
 - procedure, 2-2
 - tools required, 2-1
 - grounded thermocouples, using multiple thermocouples, D-1
- H**
- hazardous environment classification, A-2
 - heat considerations, 3-3
- I**
- ID code, 4-1
 - input channel multiplexing, 1-5
 - input circuit block diagram, 1-6
 - input data scaling, G-2
 - input device type, 5-4
 - examining in status word, 5-13
 - setting in configuration word, 5-4
 - input filter. *See* filter frequency
 - input image. *See* status word and data word
 - input response to slot disabling, 4-9
 - input specifications, A-2
 - installation, 3-1, 3-5
 - equipment required, 2-1
 - getting started, 2-1
 - heat and noise considerations, 3-3
 - location in chassis, 3-2
- L**
- LEDs, 1-2
 - channel status indicators, 1-3
 - module status indicator, 1-3
 - state tables, 7-3
 - local configuration, G-2
 - LSB, 5-4, G-2
- M**
- module ID code, 4-1
 - how to enter, 4-1
 - module operation, 1-5
 - multiplexing, 1-5
 - multiplexor, G-2
- N**
- noise filtering, 4-4
 - normal mode rejection, G-2
- O**
- open-circuit, 7-4
 - defining conditional state of channel data, 5-8
 - downscale enable, 5-8
 - upscale enable, 5-8
 - zero, 5-8
 - error condition, 7-4
 - fault detection bit, 5-14
 - out-of-range error, 7-5
 - over-range error, 5-14
 - fault bit, 5-14
 - under-range error, 5-14
 - fault bit, 5-14

output image, 4-2
output response to slot disabling, 4-9
over-range error, 5-14
 fault indicator bit, 5-14

P

physical specifications, A-1
PID input type, 5-4
PID instruction, 6-5
pinout diagram, 3-6
power requirements, 3-1
power-up sequence, 1-4
programming
 alarms, 6-6, 6-7
 configuration settings, 6-1
 initial setting, 6-1
 making changes, 6-3
 PID instruction, 6-5
 verifying channel configuration changes,
 6-4
proportional counts input, 5-4

R

reconfiguration time, 4-8

remote configuration, G-3
removable terminal block, 1-3
removing the module, 3-4
resolution, 4-4, G-3

S

sampling time, G-3
scaled-for-PID, 5-4
scaling input data, G-2
self-locking tabs, 1-3
shield connections, 3-6, 3-8
slot disabling, 4-9
specifications, A-1
 electrical, A-1
 environmental, A-2
 input, A-2
 physical, A-1
start-up instructions, 2-1
status word, 5-10, 5-11, G-3
 See also input image
step response, 4-4, G-3



Allen-Bradley, a Rockwell Automation Business, has been helping its customers improve productivity and quality for more than 90 years. We design, manufacture and support a broad range of automation products worldwide. They include logic processors, power and motion control devices, operator interfaces, sensors and a variety of software. Rockwell is one of the world's leading technology companies.

Worldwide representation.



Argentina • Australia • Austria • Bahrain • Belgium • Brazil • Bulgaria • Canada • Chile • China, PRC • Colombia • Costa Rica • Croatia • Cyprus • Czech Republic • Denmark • Ecuador • Egypt • El Salvador • Finland • France • Germany • Greece • Guatemala • Honduras • Hong Kong • Hungary • Iceland • India • Indonesia • Ireland • Israel • Italy • Jamaica • Japan • Jordan • Korea • Kuwait • Lebanon • Malaysia • Mexico • Netherlands • New Zealand • Norway • Pakistan • Peru • Philippines • Poland • Portugal • Puerto Rico • Qatar • Romania • Russia-CIS • Saudi Arabia • Singapore • Slovakia • Slovenia • South Africa, Republic • Spain • Sweden • Switzerland • Taiwan • Thailand • Turkey • United Arab Emirates • United Kingdom • United States • Uruguay • Venezuela • Yugoslavia

Allen-Bradley Headquarters, 1201 South Second Street, Milwaukee, WI 53204 USA, Tel: (1) 414 382-2000 Fax: (1) 414 382-4444