



SLC ControlNet Scanner Module

Catalog Number 1747-SCNR

Use this document to help you install the ControlNet™ 1747-SCNR Scanner module.

For information about	See page
preventing electrostatic discharge	2
compliance to European Union Directives	2
related publications	3
module features	4
preparing the module for installation	5
selecting the ControlNet node address	6
inserting the 1747-SCNR scanner into the chassis	6
connecting to a ControlNet network	8
cables	10
applying chassis power	11
status indicators	17
specifications	18

Prevent Electrostatic Discharge

The scanner module is sensitive to electrostatic discharge.

ATTENTION



Electrostatic discharge can damage integrated circuits or semiconductors if you touch backplane connector pins. Follow these guidelines when you handle the module:

- touch a grounded object to discharge static potential
- wear an approved wrist-strap grounding device
- do not touch the backplane connector or connector pins
- do not touch circuit components inside the module
- if available, use a static-safe work station
- when not in use, keep the module in its static-shield bag

Compliance to European Union Directives

If this product has the CE mark, it is approved for installation within the European and EEA regions. It has been designed and tested to meet the following directives.

EMC Directive

This product is tested to meet Council Directive 89/336/EEC Electromagnetic Compatibility (EMC) and the following standards, in whole or in part, documented in a technical construction file:

- EN 50081-2 EMC — Generic Emission Standard, Part 2 — Industrial Environment
- EN 50082-2 EMC — Generic Immunity Standard, Part 2 — Industrial Environment

This product is intended for use in an industrial environment.

Low Voltage Directive

This product is tested to meet Council Directive 73/23/EEC Low Voltage by applying the safety requirements of EN 61131-2 Equipment Requirements and Tests.

For specific information required by EN 61131-2, see the appropriate sections in this publication as well as the following Allen-Bradley publications:

- Industrial Automation Wiring and Grounding Guidelines For Noise Immunity, publication 1770-4.1
- Guidelines For Handling Lithium Batteries, publication AG-5.4
- Automation Systems Catalog, publication B113

This equipment is classified as open equipment and must be installed (mounted) in an enclosure as a means of providing safety protection.

Related Publications

For software configuration information, refer to the ControlNet 1747-SCNR Reference Manual, publication 1747-RM623B-EN-P.

For planning and installation information, refer to the ControlNet Cable System Planning and Installation Manual, publication 1786-6.2.1. If you need a copy of this manual, access the Automation Bookstore website at <http://www.theautomationbookstore.com> or the Manuals On line website at <http://www.ab.com/manuals>.

For information on terminating ControlNet coaxial cables, refer to Terminating Your ControlNet Coaxial Cables, CD number CNET-DM001A-EN-C.

Identify Scanner Module Features

Use this illustration to identify the features of the 1747-SCNR Scanner module.

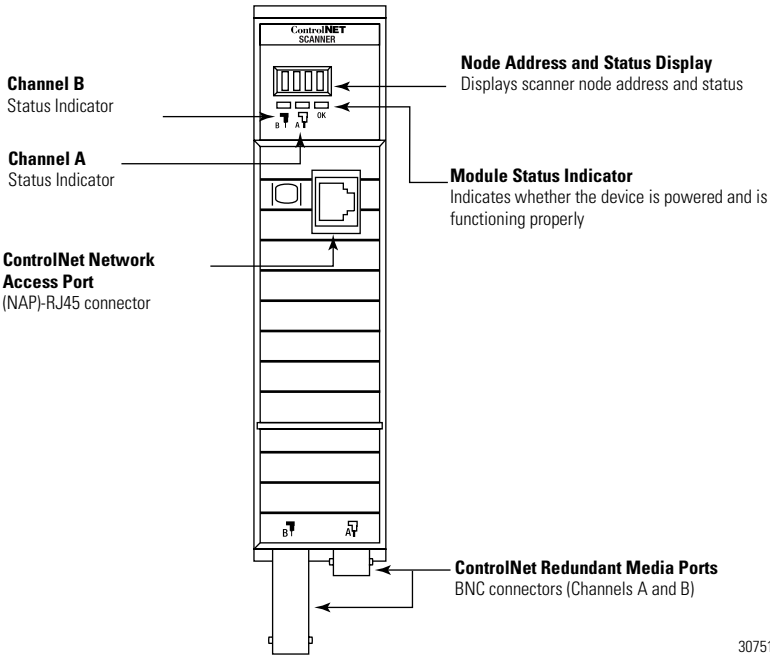

30751-M

Prepare for Module Installation

Before you install your module, you need the following items:

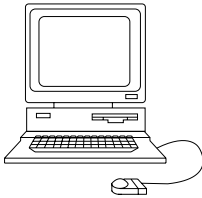

Personal Computer with
Microsoft® Windows®



RSNetWorx for
ControlNet™,
catalog number
9357-CNETL3

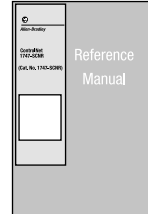

1747-SCNR Scanner Module
Reference Manual, publication
1747-RM623B-EN-P

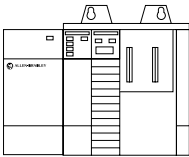

SLC™ 1746 chassis with SLC
5/02, 5/03, 5/04, or 5/05 processor and
the appropriate configuration software
(RSLogix 500™)



ControlNet 1784-PCC (shown), or
1784-PCIC, or 1784-KTCX15, or
1770-KFC15

41523

Before you install the module, you must know how to:

- program and operate an Allen-Bradley SLC 500 programmable controller
- install and configure the devices on your ControlNet network

Make Sure That Your Processor and Scanner Are Compatible

The 1747-SCNR Scanner module fits in any slot of the chassis except for the left-most slot of the first chassis, which is reserved for the SLC 500 processor.

Select the ControlNet Node Address

Select the ControlNet node address of the 1747-SCNR by setting the two 10-digit rotary switches on the top of the scanner. Valid switch settings range from 01 through 99. Zero (00) is not a valid node address.

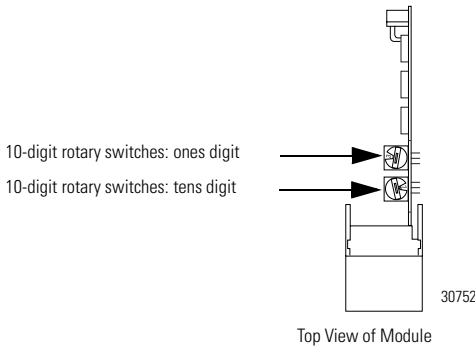

Important: Since 00 is the default value from manufacturing, you must change the default value when using the scanner for the first time.

Insert the 1747-SCNR Scanner Into the Chassis

To insert the 1747-SCNR Scanner into the SLC chassis:

1. Turn off the SLC chassis power supply.

ATTENTION



Do not install the 1747-SCNR Scanner module with the chassis power supply on. Installing the module with the chassis power supply on may damage the module.

Important: If you disconnect the ac power, you lose the chassis ground. Electrostatic damage (ESD) protection is lost.

2. Select a slot for the module in the chassis. Choose any slot except the left-most slot of the first chassis, which is reserved for the SLC 500 processor.
3. Insert the module into the slot you have selected. We recommend that you insert the 1747-SCNR Scanner as close to the chassis power supply as possible.

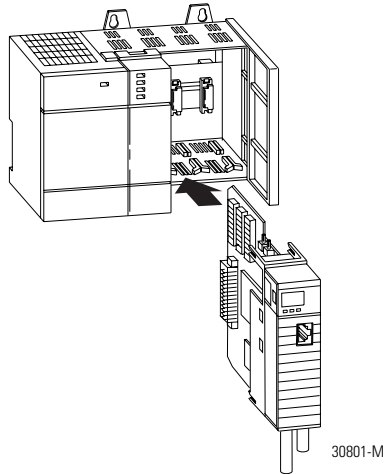

4. Apply firm, even pressure to seat the module in the I/O chassis backplane connectors.
5. Restore power to the SLC chassis.

Connect to a ControlNet Network

Connect the 1747-SCNR Scanner module to a ControlNet network via a tap with a 1m (39.4 in.) drop cable.

Four Allen-Bradley ControlNet taps are available from Rockwell Automation as shown below.

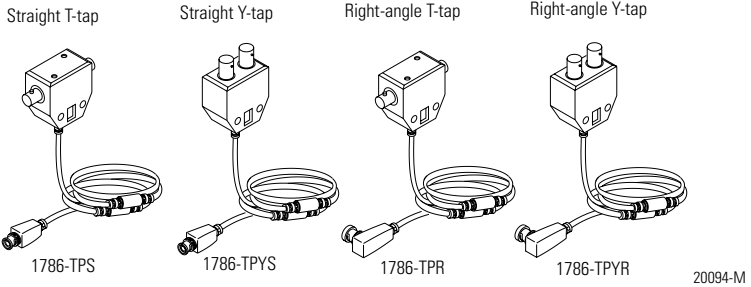

We recommend that you use a tap with a straight connector—1786-TPS or 1786-TPYS—when you attach a ControlNet 1747-SCNR Scanner to a ControlNet network.

Important: Allen-Bradley ControlNet taps contain passive electronics and must be purchased from Rockwell Automation for the network to function properly.

After terminating your network segments, connect your node to the network.

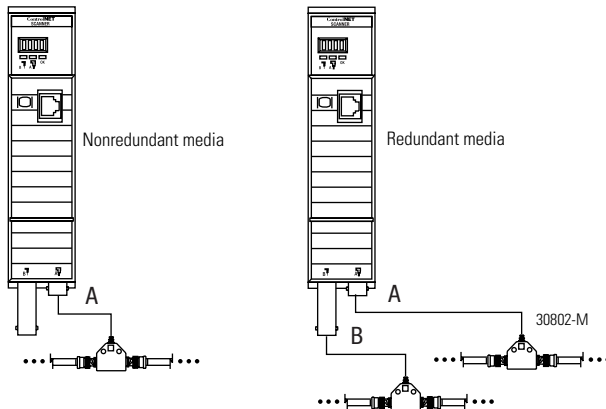

Remove the tap's dust cap—located on the straight or right-angle connector—and set it aside.

If your network supports	Connect the tap's straight or right-angle connector
nonredundant media	to the channel A connector on the scanner— channel B is not used. ¹
redundant media	from trunk-cable A to channel A on the scanner and from trunk-cable B to channel B on the scanner.

1. Rockwell Automation recommends using channel A for nonredundant media.

For detailed information about planning and installing your ControlNet system, see the following information sources.

Source	Source Number
ControlNet Coax Cable System Planning and Installation Manual	1786-6.2.1
ControlNet Media System Component List	AG-2.2
ControlNet Coax Tap Installation Instructions	1786-5.7
ControlNet Network Access Cable Installation Instructions	1786-2.6
ControlNet Repeater Installation Instructions	1786-2.7
Industrial Automation Wiring and Grounding Guidelines	1770-4.1
Terminating Your ControlNet Coaxial Cables	CNET-DM001A-EN-C

Cables

Several types of RG-6 quad-shield cables may be appropriate for your ControlNet installation—depending on the environment factors associated with your application and installation site.

The following Allen-Bradley ControlNet cable system components are available from Rockwell Automation:

Item ¹	Cat. No.
ControlNet Coax Tool Kit - ControlNet Coax Tool (enables you to make successful coaxial cables)	1786-CTK
Coax Tap Kit	Right-angle T-tap Straight T-tap Right-angle Y-tap Straight Y-tap
	1786-TPR 1786-TPS 1786-TPYR 1786-TPYS
Repeaters	Dual channel coaxial repeater
	1786-RPCD
Fiber Optic Repeaters	Low-voltage dc coax adapter
	1786-RPA
	Short-range fiber module
	1786-RPFS
	Medium-range fiber module
	1786-RPFM
RG-6 Quad Shield Cable	Standard-PVC CM-CL2
	1786-RG6
ControlNet Network Access Cable—3.05 m (10 ft)	
	1786-CP
BNC Connectors	Barrel (plug to plug)
	1786-BNCP
	BNC/RG-6 plug
	1786-BNC
	Bullet (jack to jack)
	1786-BNCJ
	Isolated-bulkhead (jack to jack)
	1786-BNCJI
	Terminators (BNC-75Ω)
	1786-XT

1. For a complete list of Allen-Bradley ControlNet cable system components that are available from Rockwell Automation and cable system components available from other suppliers, see the ControlNet Media System Component List, publication AG-2.2.

Important: Install all wiring for your ControlNet system in accordance with the regulations contained in the National Electronic Code (or applicable country codes), state codes, and applicable municipal codes.

For detailed information about ControlNet cabling, see the ControlNet System Overview, publication 1786-SO009A-EN-P and the publications listed in the table on the previous page.

Apply Chassis Power

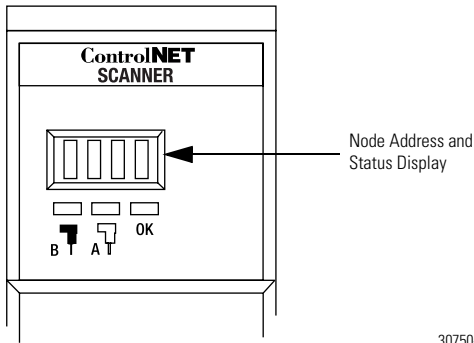

30750-M

When you apply chassis power, the module address and status display cycles through the following displays:

1. **POST** - The 1747-SCNR runs Power On Self Test.
2. **1111, 2222, etc.** - The 1747-SCNR is executing its startup sequence.
3. **REV#, S/R, QXXX** - The 1747-SCNR firmware version temporarily displays after startup: S=series, R=revision, and XXX=build number.
4. **A#nn** (where nn = ControlNet node address) then **I/OI** or **I/OX** (based on the number of connections configured and established) then **IDLE** or **RUN** (based on the scanner mode).

Alphanumeric Display

The four character alphanumeric display provides you with additional visual information about the current operating status of the module.





The following tables describes problems that may occur while using your 1747-SCNR, the probable causes, and the recommended action.

OK Indicator and Display Mnemonics

The OK indicator is handled consistently with the ControlNet specifications for the Identity object.

Sequence	OK Indicator	Alphanumeric Display	Module Status Word (M1 file)	Description	Probable Cause	Recommended Action
Startup	Alternately red/ green	POST	N/A	The 1747-SCNR module is running Power On Self Test.	Power was applied to the module.	No action required.
		REV# S/R QXXX	N/A	1747-SCNR Firmware revision: S=series R=Revision XXX=build number. This is a temporary display after startup.	Power was applied to the module.	No action required.
Run time	Green	A#XX	N/A	ControlNet node address	None	No action required.
		I/O ■	0x26	All configured connections are established.	None	No action required.
		IDLE	N/A	The scanner is in idle mode.	The SLC processor or adapter in slot 0 is in program mode or the Scanner Mode Command bit of the Module Command word is clear (0:x.0/10 where x is the scanner slot number).	If you want to put the scanner into run mode, put the SLC processor in slot 0 into run mode and set the Scanner Mode Command bit of the Module Command word (0:x.0/10) using an unconditional OTE instruction.

Sequence	OK Indicator	Alphanumeric Display	Module Status Word (M1 file)	Description	Probable Cause	Recommended Action
Run time	Green	RUN	N/A	The scanner is in run mode.	The SLC processor in slot 0 is in run mode and the Scanner mode Command bit of the Module Command word is set (0:x.0/10).	If you want to put the scanner into program mode, either put the SLC processor in slot 0 into program mode or clear the Scanner Mode Command bit of the Module Command word (0:x.0/10).
		EDIT	N/A	The scanlist in the 1747-SCNR is being modified.	Edits have been enabled with RSNetWorx for ControlNet. Note: Previously configured connections will be reestablished if lost. Newly configured or changed connections will not be established until edits are accepted.	Finish modifying the scanlist with RSNetWorx for ControlNet and then accept edits. <hr/> Cancel edits with RSNetWorx for ControlNet.
	Flashing Green	I/OX	0x20	The scanner is not configured.	Module not configured.	Use RSNetWorx for ControlNet to download a new configuration.
0x21			The current configuration is not valid. The scanner is not able to start any scheduled communication to remote devices. Only unscheduled communication is possible.	Module not configured properly.	Use RSNetWorx for ControlNet to schedule the existing configuration. <hr/> Use RSNetWorx for ControlNet to download a new configuration.	





Sequence	OK Indicator	Alphanumeric Display	Module Status Word (M1 file)	Description	Probable Cause	Recommended Action	
Run time	Flashing Green	I/O 	0x22	Connections are configured but no connections are established.	View the Connection Status screen in RSNetWorx for ControlNet to see why the connections are not established.	Check to see if the 1747-SCNR and the remote devices are correctly connected to the ControlNet network.	
		I/O 	0x23	Connections are configured but only 25% are successfully established.			
		I/O 	0x24	50%	Module bandwidth is exceeded.	Reduce the number of scheduled connections by: - using a discrete rack connection instead of multiple discrete module connections - combining multiple I/O racks into a single I/O rack - combining multiple peer-to-peer messages into one message.	
		I/O 	0x25	75%			
							Increase your Network Update Time and/or increase the Requested Packet Intervals for scheduled data transfers.
							Increase your SLC 500 ladder program scan by adding more logic.

Sequence	OK Indicator	Alphanumeric Display	Module Status Word (M1 file)	Description	Probable Cause	Recommended Action
Run time	Flashing Green	EDIT	N/A	The scanlist in the 1747-SCNR is being modified.	Edits have been enabled with RSNetWorx for ControlNet. Note: Previously configured connections will be reestablished if lost. Newly configured or changed connections will not be established until edits are accepted.	Finish modifying the scanlist with RSNetWorx for ControlNet and then accept edits. <hr/> Cancel edits with RSNetWorx for ControlNet.
		SIGM	N/A	A scanner signature mismatch has been detected. The 1747-SCNR scanner signature does not match the signature stored in the active keeper. The scanner is not able to start any scheduled communication to remote devices. Only unscheduled communication is possible.	Module is not configured properly.	Use RSNetWorx for ControlNet to schedule the existing configuration. <hr/> Use RSNetWorx for ControlNet to download a new configuration.

Sequence	OK Indicator	Alphanumeric Display	Module Status Word (M1 file)	Description	Probable Cause	Recommended Action
Errors	Off	None	N/A	Module is not communicating	Power supply fault.	Check power supply, cable connectors, and seat module firmly in chassis.
	Flashing Green	N/A	0x43	Network error	Cable error or no other nodes on the network.	Verify network cabling.
	Red	(Scrolling display showing fault details)	N/A	Module faulted	Internal error detected.	Record fault details and contact Rockwell Automation representative or distributor.
	Flashing Red	A#00 FLSH CFG ERAS	0x42	Module erased network and connection configuration stored in flash.	Network node address set to 00.	Power down the module and change the address switches.
		DUPL A#XX	0x44	Duplicate node address	Another device with the same ControlNet address is on the link.	Power down the 1747-SCNR module and change the network address switches to a correct node.

Status Indicators

The ControlNet status indicators inform you of the operational state of the ControlNet network.

Indicator	Color ¹	Probable Cause	Recommended Action
A  and  B	Off	No power	No action required or apply power.
	Steady Red	Faulty unit	Cycle power or reset unit. If fault persists, contact your Rockwell Automation representative or distributor.
	Alternating Red/Green	Self-test	No action required.
	Alternating Red/Off	Incorrect node configuration or duplicate ControlNet node address	Check network address and other ControlNet configuration parameters.
A  or  B	Off	Channel disabled	Program network for redundant media, if required.
	Steady Green	Normal operation	No action required.
	Flashing Green/Off	Temporary network errors	<ul style="list-style-type: none"> • Check media for broken cables, loose connectors, missing terminators, etc. • If condition persists, refer to ControlNet Cable Planning and Installation Manual, publication 1786-6.2.1.
	Flashing Red/Off	Media fault	<ul style="list-style-type: none"> • Check media for broken cables, loose connectors, missing terminators, etc. • If condition persists, refer to ControlNet Cable Planning and Installation Manual, publication 1786-6.2.1.
		No other nodes present on network	Add other nodes to the network.
	Flashing Red/Green	Incorrect node address	Change 1747-SCNR node address so that it is less than or equal to SMAX ² .
		Incorrect network configuration	Reconfigure ControlNet network so that SMAX ² is greater than or equal to 1747-SCNR node address.

1. Definition of terms:

steady - indicator is on continuously in the defined state.

alternating - the two indicators alternate between the two defined states at the same time (applies to both indicators *viewed together*); the two indicators are always in opposite states, out of phase.

flashing - the indicator alternates between the two defined states (applies to each indicator *viewed independent* of the other); if both indicators are flashing, they flash together, in phase.

2. SMAX is the highest node address on a ControlNet network that can transmit scheduled data.

Hazardous Location Approval

The following information applies only to products marked with Hazardous Location Approval, when operating in hazardous locations:

Products marked “CL I, DIV 2, GP A, B, C, D” are suitable for use in Class I Division 2 Groups A, B, C, D, Hazardous Locations and nonhazardous locations only. Each product is supplied with markings on the rating nameplate indicating the hazardous location temperature code. When combining products within a system, the most adverse temperature code (lowest “T” number) may be used to help determine the overall temperature code of the system. Combinations of equipment in your system are subject to investigation by the local Authority Having Jurisdiction at the time of installation.

WARNING**EXPLOSION HAZARD -**

- Do not disconnect equipment unless power has been removed or the area is known to be nonhazardous.
- Do not disconnect connections to this equipment unless power has been removed or the area is known to be nonhazardous. Secure any external connections that mate to this equipment by using screws, sliding latches, threaded connectors, or other means provided with this product.
- Substitution of components may impair suitability for Class I, Division 2.
- If this product contains batteries, they must only be changed in an area known to be nonhazardous.

WARNING

Use supply wires suitable for 30°C above surrounding ambient.

WARNING

When used in a Class I, Division 2, hazardous location, this equipment must be mounted in a suitable enclosure with proper wiring method that complies with the governing electrical codes.

Les informations suivantes ne concernent que les produits marqués pour une utilisation en environnements dangereux :

Les produits marqués « CL I, DIV 2, GP A, B, C, D » ne conviennent qu'à une utilisation en environnements de Classe I Division 2 Groupes A, B, C, D dangereux et non dangereux. Chaque produit est livré avec des marquages sur sa plaque d'identification qui indiquent le code de température pour les environnements dangereux. Lorsque plusieurs produits sont combinés dans un système, le code de température le plus défavorable (code de température le plus faible) peut être utilisé pour déterminer le code de température global du système. Les combinaisons d'équipements dans le système sont sujettes à inspection par les autorités locales qualifiées au moment de l'installation.

AVERTISSEMENT**RISQUE D'EXPLOSION -**

- Couper le courant ou s'assurer que l'environnement est classé non dangereux avant de débrancher l'équipement.
 - Couper le courant ou s'assurer que l'environnement est classé non dangereux avant de débrancher les connecteurs. Fixer tous les connecteurs externes reliés à cet équipement à l'aide de vis, loquets coulissants, connecteurs filetés ou autres moyens fournis avec ce produit.
 - La substitution de composants peut rendre cet équipement inadapté à une utilisation en environnement de Classe I, Division 2.
 - S'assurer que l'environnement est classé non dangereux avant de changer les piles.
-





AVERTISSEMENT

Utiliser des fils d'alimentation qui conviennent à une température de 30°C au-dessus de la température ambiante.

AVERTISSEMENT

Pour une utilisation en environnement de classe i, division 2 dangereux, cet équipement doit être monté dans un boîtier avec un câblage approprié conforme aux normes électriques en vigueur.

Specifications

Module Location	Slot 1 or above
Module Defaults	Node Address -00
Maximum Backplane Current	900 mA @ 5V dc
Isolated Voltage	Optical Isolation between backplane and ControlNet channel 1 Megohm resistor from ControlNet channel to chassis
Environmental Conditions: Operational Temperature Storage Temperature Relative Humidity	0-60°C (32-140°F) -40 to 85°C (-40 to 185°F) 5-95% without condensation
Shock unpackaged	30g operational 50g non-operational
Vibration Unpackaged	5g from 10-150Hz
Immunity Radiated Fields	10 V/m 27 mHz-1000 mHz
Agency Certification (when product or packaging is marked)	  Class 1 Division 2, groups A, B, C, D2  marked for all applicable directives 
Reference Manual	1747-RM623B-EN-P

Allen-Bradley is a registered trademark of Rockwell Automation.

SLC is a trademark of Rockwell Automation.

ControlNet is a trademark of ControlNet International.

Microsoft Windows is a registered trademark of Microsoft Corporation.

RSNetWorx for ControlNet and RSLogix 500 are trademarks of Rockwell Software, Inc.

CSA logo is a registered trademark of the Canadian Standards Association.

Le sigle CSA est la marque déposée de l'Association des Standards pour le Canada.

Reach us now at www.rockwellautomation.com

Wherever you need us, Rockwell Automation brings together leading brands in industrial automation including Allen-Bradley controls, Reliance Electric power transmission products, Dodge mechanical power transmission components, and Rockwell Software, Rockwell Automation's unique, flexible approach to helping customers achieve a competitive advantage is supported by thousands of authorized partners, distributors and system integrators around the world.

Americas Headquarters, 1201 South Second Street, Milwaukee, WI 53204, USA, Tel: (1) 414 382-2000, Fax: (1) 414 382-4444
European Headquarters SA/NV, avenue Herrmann Debroux, 46, 1180 Brussels, Belgium, Tel: (32) 2 663 06 00, Fax: (32) 2 663 06 40
Asia Pacific Headquarters, 27/F Citicorp Centre, 18 Whitfield Road, Causeway Bay, Hong Kong, Tel: (852) 2887 4788, Fax: (852) 2508 1846



Publication 1747-IN059A-EN-P - February 2001

Supersedes Publication 1747-5.36 - June 2000

PN 957445-91

© 2001 Rockwell International Corporation. Printed in the U.S.A.