



Universal Serial Bus (USB) to DH-485 Interface Converter

Catalog Number 1747-UIC

Inside	page
Overview	3
Specifications	3
Computer and Operating System Requirements	3
Mounting	3
Understanding the LEDs	3
Quick Start	4
Making Cable Connections	5
Installing Drivers	7
Identifying the Assigned COM Port	12
Uninstalling the Drivers	12
Configuring the 1747-UIC in RSLinx	12
Troubleshooting	15
Hazardous Location Considerations	16
Environnements dangereux	16

Allen-Bradley Auto

Important User Information



Because of the variety of uses for the products described in this publication, those responsible for the application and use of these products must satisfy themselves that all necessary steps have been taken to assure that each application and use meets all performance and safety requirements, including any applicable laws, regulations, codes and standards. In no event will Rockwell Automation be responsible or liable for indirect or consequential damage resulting from the use or application of these products.

Any illustrations, charts, sample programs, and layout examples shown in this publication are intended solely for purposes of example. Since there are many variables and requirements associated with any particular installation, Rockwell Automation does not assume responsibility or liability (to include intellectual property liability) for actual use based upon the examples shown in this publication.

Allen-Bradley publication SGI-1.1, *Safety Guidelines for the Application, Installation and Maintenance of Solid-State Control* (available from your local Rockwell Automation office), describes some important differences between solid-state equipment and electromechanical devices that should be taken into consideration when applying products such as those described in this publication.

Reproduction of the contents of this copyrighted publication, in whole or part, without written permission of Rockwell Automation, is prohibited.

Throughout this publication, notes may be used to make you aware of safety considerations. The following annotations and their accompanying statements help you to identify a potential hazard, avoid a potential hazard, and recognize the consequences of a potential hazard:

<p>WARNING</p> 	<p>Identifies information about practices or circumstances that can cause an explosion in a hazardous environment, which may lead to personal injury or death, property damage, or economic loss.</p>
<p>ATTENTION</p> 	<p>Identifies information about practices or circumstances that can lead to personal injury or death, property damage, or economic loss.</p>
<p>IMPORTANT</p>	<p>Identifies information that is critical for successful application and understanding of the product.</p>

Overview

The 1747-UIC allows you to connect devices that communicate using DH-485 protocol directly to a computer's USB port, using either the 1747-UIC's RS-232 or RS-485 port and user-provided programming cables. Three LEDs on the 1747-UIC indicate communication status.

Specifications

Dimensions	3.18 in. (H) x 1.83 in. (W) x 0.97 in. (D) 80.8 mm (H) x 46.5 mm (W) x 24.5 mm (D)
Temperature Range	0 to 60°C (32 to 140°F)
USB Speed	USB 1.1 (12 Mbps)
USB Power Consumption	< 100 mA (low power)
DH-485 Baud Rate	19.2 Kbps

Computer and Operating System Requirements

The USB to DH-485 interface converter works with RSLinx version 2.41 or higher and Windows98/2000/XP, on computers equipped with USB ports.

Mounting

The 1747-UIC can be mounted on a DIN rail using the DIN rail mounting kit (included).

Understanding the LEDs

The 1747-UIC has three green LEDs, which indicate the following when lit:

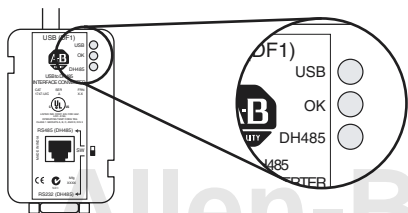

LED	Indication
OK (solid)	USB is powered and operational
USB (flashing)	USB port is transmitting or receiving DF1 data
DH-485 (flashing)	Actively passing token or data on DH-485 network

Quick Start

1. Slide the switch (SW) on the 1747-UIC to indicate which port you will connect to, as shown below.

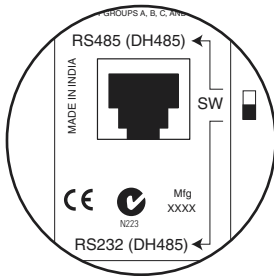

Set for RS-232 port

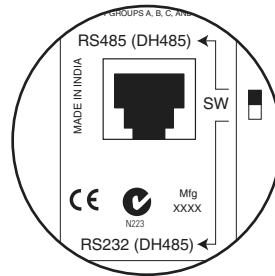

Set for RS-485 port

2. To ensure proper ground, make cable connections between the 1747-UIC and the DH-485 device or interface first. See Making Cable Connections on pages 5 and 6.
3. Plug the 1747-UIC USB cable into the computer's USB port. The green OK LED should turn on to indicate that the 1747-UIC is receiving power through the USB port.
4. If this is the first time that this 1747-UIC has been connected to this computer, you must install the 1747-UIC drivers. See Installing Drivers on page 7.
5. Identify which COM port has been assigned to the 1747-UIC. See Identifying the Assigned COM Port on page 12.
6. Create an RS-232 DF1 Driver within RSLinx. See Configuring the 1747-UIC in RSLinx on page 12.
7. Verify DH-485 communications using RSWho. Both the USB and DH-485 green LEDs should be flashing when communications are working.

IMPORTANT

Always stop the RSLinx RS-232 DF1 driver or shut down RSLinx prior to unplugging the 1747-UIC from the computer's USB port.

Making Cable Connections

Connecting DH-485 Devices to the 1747-UIC's RS-485 Port

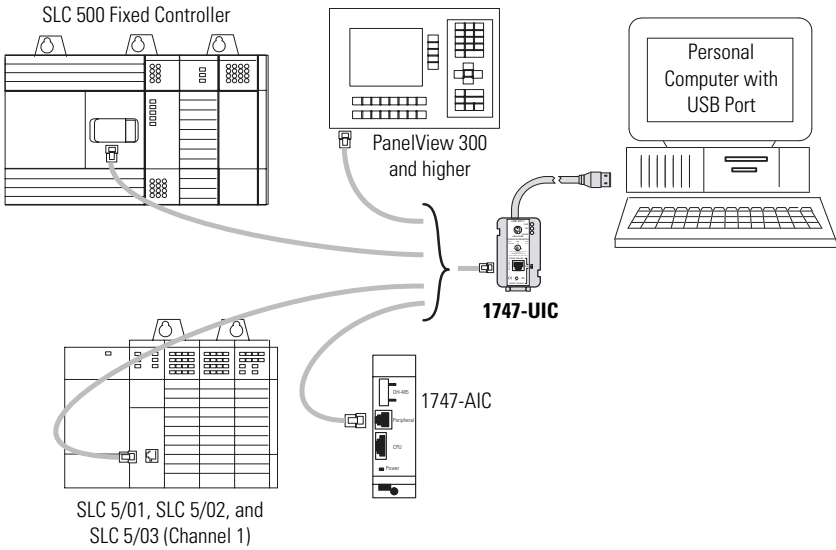

Connect the following DH-485 equipment to the RS-485 port	using cable
SLC 500 Fixed Controller	1747-C13
SLC 5/01, SLC 5/02, and SLC 5/03 (Channel 1)	
1747-AIC Isolated Link Coupler	
PanelView 300 and higher with DH-485 port	1747-C10

ATTENTION



To avoid ESD damage to the 1747-UIC, always connect the 1747-UIC to the properly grounded DH-485 device or interface prior to plugging the USB cable into the computer's USB port.

Connecting DH-485 Devices to the 1747-UIC's RS-232 Port

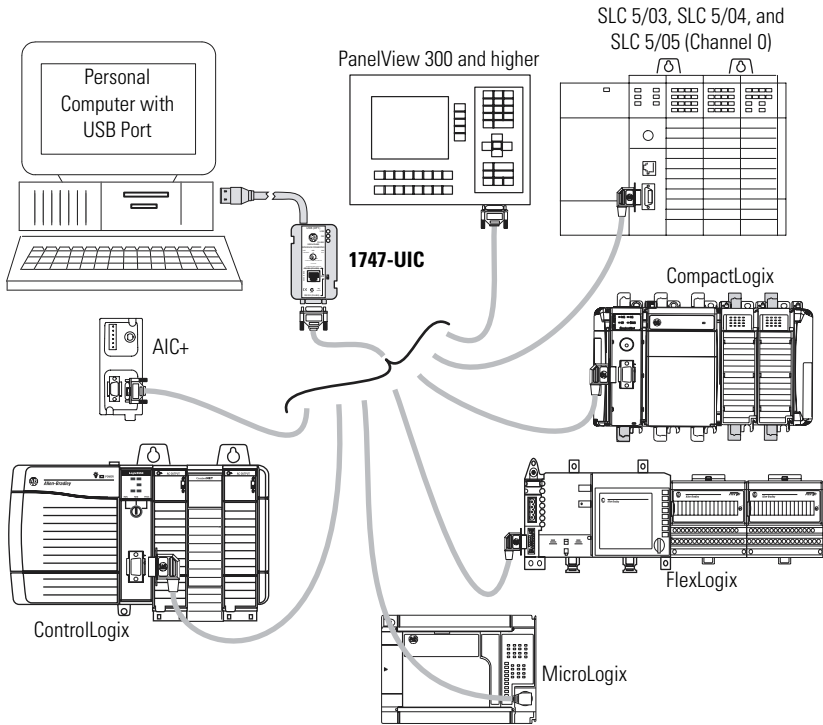

Connect the following DH-485 equipment to the RS-232 port	using cable
SLC 5/03, SLC 5/04, and SLC 5/05 (Channel 0)	1747-CP3, 1756-CP3
1761-NET-AIC (AIC+) Advanced Interface Converter	1747-CP3, 1756-CP3 (Port P, 9-pin D) 1761-CBL-PM02 (Port 2, 8-pin DIN)
PanelView 300 and higher with RS-232 (DH-485) port	2711-NC13 or equivalent
MicroLogix PanelView 300 Micro (DH-485)	1761-CBL-PM02 or equivalent
CompactLogix	1747-CP3, 1756-CP3
FlexLogix	1747-CP3, 1756-CP3
ControlLogix	1747-CP3, 1756-CP3

ATTENTION



To avoid ESD damage to the 1747-UIC, always connect the 1747-UIC to the properly grounded DH-485 device or interface prior to plugging the USB cable into the computer's USB port.

Installing Drivers

To install the 1747-UIC, you must install drivers for both the 1747-UIC and the USB serial port. Follow the steps below.

1. If you have RSLinx version 2.41, you must first copy all the files on the enclosed diskette to the RSLinx subdirectory on your PC. If you have a version of RSLinx greater than version 2.41, the drivers were already copied to your computer during the RSLinx installation.
2. Plug the 1747-UIC into your PC's USB port. Verify that the OK LED is on (solid).
3. The Found New Hardware screen shows the Allen-Bradley 1747-UIC.

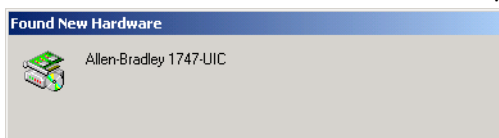
**TIP**

If the 1747-UIC screen (above) does not appear within 30 seconds after you plug the 1747-UIC into the computer's USB port, then either the computer has already been configured for this 1747-UIC, or there is a problem with the USB port on the computer.

You can determine whether the computer was previously configured for this 1747-UIC by checking the computer's COM port assignments. See Identifying the Assigned COM Port on page 12.

4. The Found New Hardware Wizard appears. Click Next.

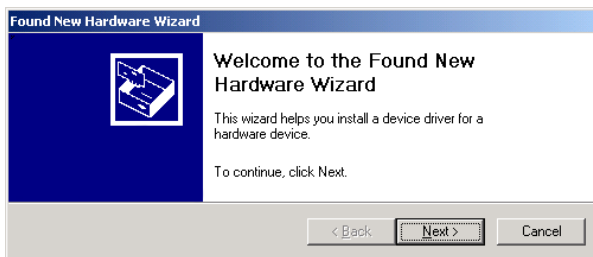
**TIP**

The screens shown in this publication are from a Windows 2000 system.

5. The Install Hardware Device Drivers screen appears with “Search for a suitable driver...” selected as the default. Click Next.

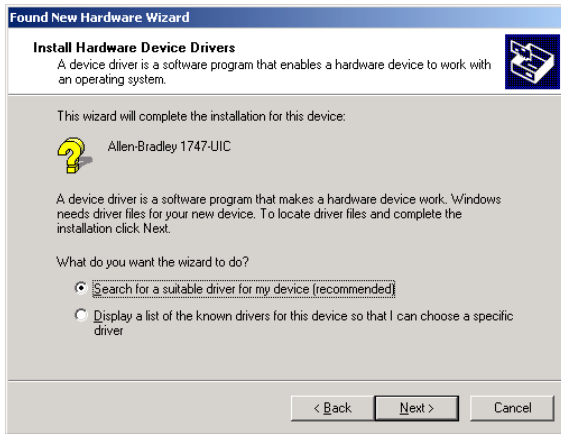

6. When the Locate Driver Files screen appears, select “Specify a location” and click Next.

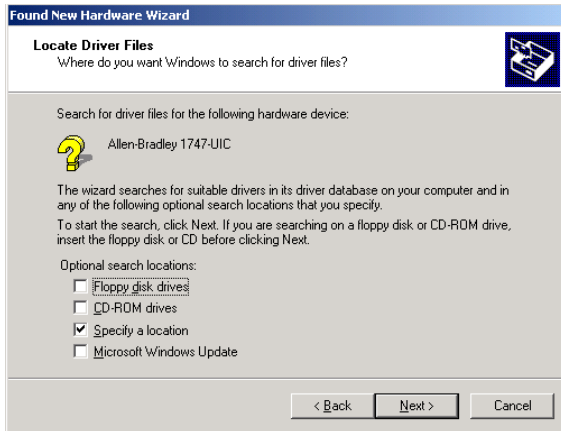

7. Browse to the RSLinx subdirectory. Click OK.



- When the wizard indicates that it has found the driver for the 1747-UIC, click Next.

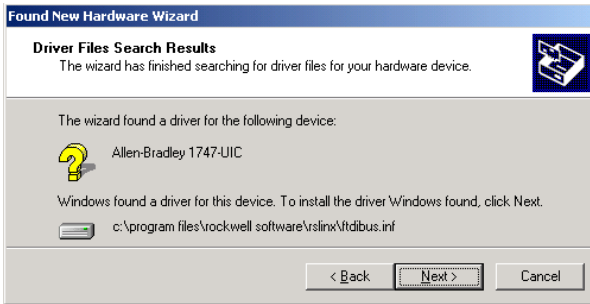

- Click Finish to complete the installation of the 1747-UIC.



If you have Windows98/ME, your installation completes automatically and you may proceed directly to Identifying the Assigned COM Port on page 12. Otherwise, continue with step 10.

- The Found New Hardware Wizard continues immediately with installation of the USB serial port. Click Next.

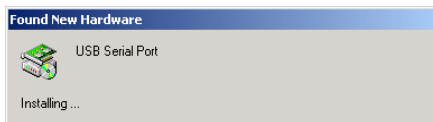

11. The Install Hardware Device Drivers screen appears with “Search for a suitable driver...” selected as the default. Click Next.

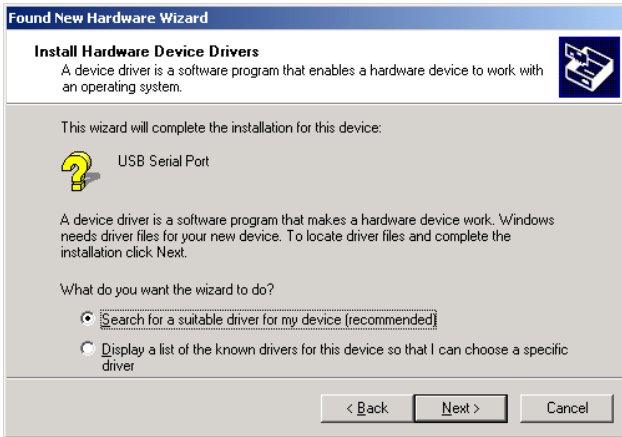

12. When the Locate Driver Files screen appears, select “Specify a location” and click Next.

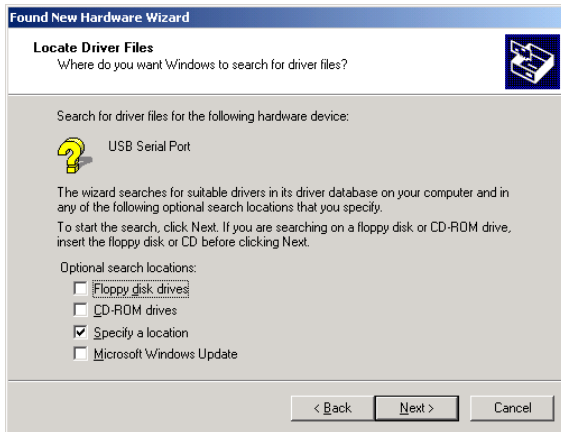

13. Browse to the RSLinx subdirectory. Click OK.



14. When the wizard indicates that it has found the driver for the USB Serial Port, click Next.

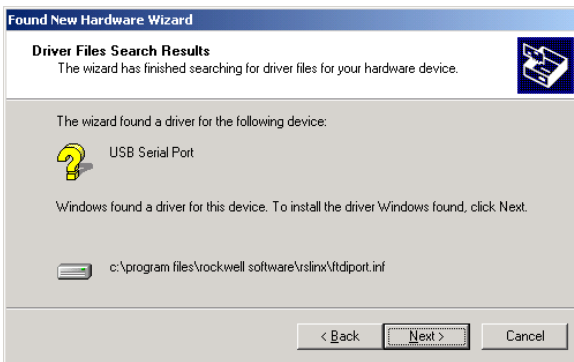

15. Click Finish to complete the installation of the USB Serial Port.

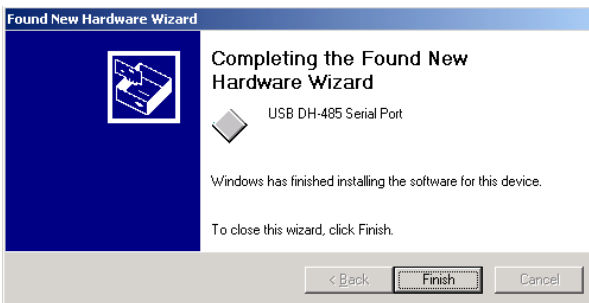

Identifying the Assigned COM Port

Identify the assigned COM port using Device Manager, as shown below.

Using Windows® 98/ME	From the Start menu, select Settings →Control Panel →System. From the System Properties Window, select the Device Manager tab. Click the View devices by type radio button.
Using Windows® 2000	From the Start menu, select Settings →Control Panel →System. From the System window, select the Hardware tab and click the Device Manager button. From the Device Manager, select View →Devices by Type.
Using Windows® XP	From the Start menu, select Control Panel →Performance and Maintenance →System Properties. From the System window, select the Hardware tab and click the Device Manager button. From the Device Manager, select View →Devices by Type.

TIP

The 1747-UIC will only show up under Device Manager when it is plugged into the computer's USB port, with the OK LED on (solid), and when the 1747-UIC drivers are installed. If the drivers have not yet been installed, see Installing Drivers on page 7.

Example Using Windows® 2000

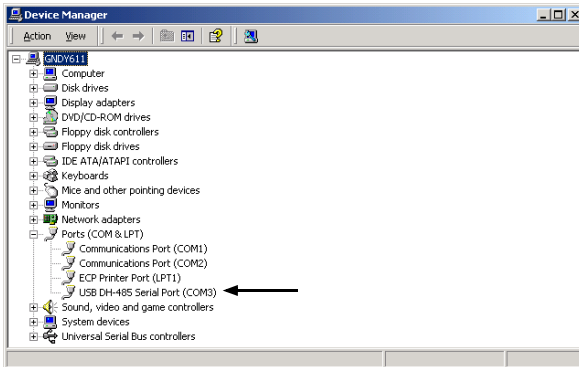

Uninstalling the Drivers

To uninstall the 1747-UIC drivers from a computer, execute the "Ftdiunin.exe" file, located in the RSLinx subdirectory.

Configuring the 1747-UIC in RSLinx

1. Launch RSLinx.

2. Select Configure Drivers from the Communications menu.
3. Select “RS-232 DF1 devices” from the Available Driver Types pulldown menu and click on Add New...

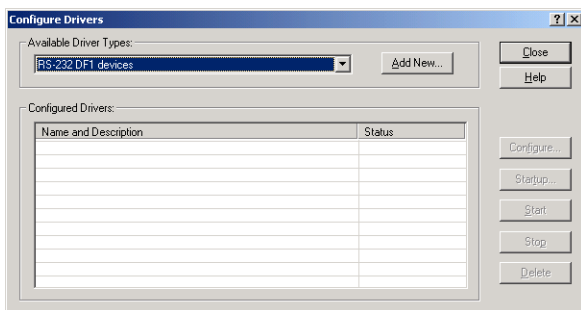

4. Choose a name for your new driver and click OK.

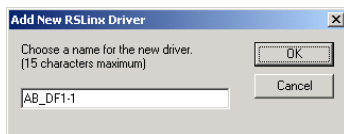

5. Select the COM Port to which the 1747-UIC is associated, in this case COM 3.

TIP

You can determine the COM port to which the 1747-UIC is assigned using the Device Manager. See Identifying the Assigned COM Port on page 12.

Select 1770-KF3/1747-KE as the Device, and make sure that Error Checking is set to CRC. Do not click AutoConfigure.

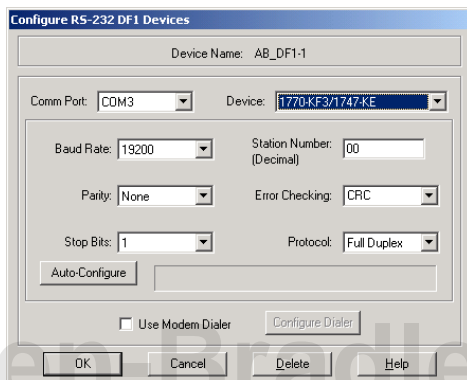

Assign the 1747-UIC an unused station number on the DH-485 network to which you are connecting. The 1747-UIC cannot go online to a DH-485 network if its assigned station number is already being used. Station number 0 is typically reserved for use by RSLinx, but any station number from 0 to 31 is valid.

Click OK.

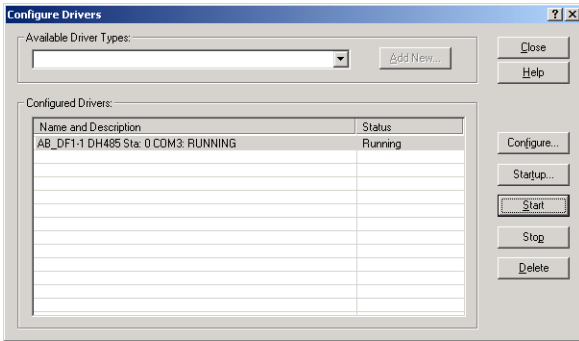

The 1747-UIC appears on the network at node 0, as shown in the example below.

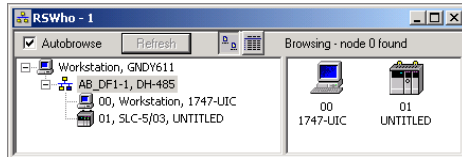

IMPORTANT

Always stop the RSLinx RS-232 DF1 driver or shut down RSLinx prior to unplugging the 1747-UIC from the computer's USB port.

Troubleshooting

If the LEDs indicate	The following error exists	Probable Cause	Recommended Action
<ul style="list-style-type: none"> • All LEDs off 	No power to 1747-UIC	No power from USB port	<ol style="list-style-type: none"> 1. Check cable connection to computer's USB port. 2. Verify power to the computer and it's USB port. 3. Plug the 1747-UIC into a different computer's USB port to verify the condition of the 1747-UIC.
<ul style="list-style-type: none"> • OK LED on solid • USB LED off • DH-485 LED off 	No communication occurring through USB or DH-485 ports	RSLinx is not yet attempting to communicate through the 1747-UIC	<ol style="list-style-type: none"> 1. Check which COM port the 1747-UIC is configured for. See Identifying the Assigned COM Port on page 12. 2. Verify that the RSLinx RS-232 DF1 driver is assigned to this COM port, is configured as shown on page 13, and is running, as shown on page 14.
<ul style="list-style-type: none"> • OK LED on solid • USB LED flashing • DH-485 LED off 	No DH-485 communications	Duplicate station address	<ol style="list-style-type: none"> 1. Verify the existing station addresses on the DH-485 network and make sure that the RSLinx RS-232 DF1 driver is assigned to an unused station address in the 0 to 31 range.
<ul style="list-style-type: none"> • OK LED on solid • USB LED flashing • DH-485 LED flashing 	RSWho doesn't display any devices on the DH-485 network other than the 1747-UIC	Improper connection to DH-485 network or improper configuration of RSLinx RS-232 DF1 driver	<ol style="list-style-type: none"> 1. Verify that the SW switch is in the correct position for the DH-485 connector being used. 2. Verify that the correct cable is being used. See Making Cable Connections on page 5. 3. Verify that the Device type in the RS-232 DF1 driver configuration is 1770-KF3/1747-KE so that RSWho will browse stations 0 through 31.

Hazardous Location Considerations

This equipment is suitable for use in Class I, Division 2, Groups A, B, C, D, or non-hazardous locations only. The following WARNING applies to use in hazardous locations.

WARNING**EXPLOSION HAZARD**

- Substitution of components may impair suitability for Class I, Division 2.
 - Do not replace components or disconnect equipment unless power has been switched off.
 - Do not connect or disconnect components unless power has been switched off.
 - This product must be installed in an enclosure.
 - All wiring must be in accordance with Class 1, Division 2 wiring methods, N.E.C. article 501-4(b), NFPA 70, and in accordance with the authority having jurisdiction.
-

Environnements dangereux

Cet équipement est conçu pour être utilisé dans des environnements de Classe 1, Division 2, Groupes A, B, C, D ou non dangereux. La mise en garde suivante s'applique à une utilisation dans des environnements dangereux.

AVERTISSEMENT**DANGER D'EXPLOSION**

- La substitution de composants peut rendre cet équipement impropre à une utilisation en environnement de Classe 1, Division 2.
 - Ne pas remplacer de composants ou déconnecter l'équipement sans s'être assuré que l'alimentation est coupée.
 - Ne pas connecter ou déconnecter des composants sans s'être assuré que l'alimentation est coupée.
-

SLC is a registered trademark of Rockwell Automation.

CompactLogix, ControlLogix, FlexLogix, MicroLogix, PanelView, and RSLinx are trademarks of Rockwell Automation.

Windows is a registered trademark of Microsoft Corporation.

www.rockwellautomation.com

Corporate Headquarters

Rockwell Automation, 777 East Wisconsin Avenue, Suite 1400, Milwaukee, WI, 53202-5302 USA, Tel: (1) 414.212.5200, Fax: (1) 414.212.5201

Headquarters for Allen-Bradley Products, Rockwell Software Products and Global Manufacturing Solutions

Americas: Rockwell Automation, 1201 South Second Street, Milwaukee, WI 53204-2496 USA, Tel: (1) 414.382.2000, Fax: (1) 414.382.4444

Europe: Rockwell Automation SA/NV, Vorstlaan/Boulevard du Souverain 36-BP 3A/B, 1170 Brussels, Belgium, Tel: (32) 2 663 0600, Fax: (32) 2 663 0640

Asia Pacific: Rockwell Automation, 27/F Citicorp Centre, 18 Whitfield Road, Causeway Bay, Hong Kong, Tel: (852) 2887 4788, Fax: (852) 2508 1846

Headquarters for Dodge and Reliance Electric Products

Americas: Rockwell Automation, 6040 Ponders Court, Greenville, SC 29615-4617 USA, Tel: (1) 864.297.4900, Fax: (1) 864.281.2433

Europe: Rockwell Automation, Brühlstraße 22, D-74834 Elztal-Dallau, Germany, Tel: (49) 6261 9410, Fax: (49) 6261 17741

Asia Pacific: Rockwell Automation, 55 Newton Road, #11-01/02 Revenue House, Singapore 307987, Tel: (65) 351 6723, Fax: (65) 355 1733

Publication 1747-IN063A-EN-P - March 2003

PN 40071-155-01(1)

Copyright © 2003 Rockwell Automation, Inc. All rights reserved. Printed in the U.S.A.