



ControlLogix Multi-Vendor Interface Module

Catalog Number 1756-MVI

Use this manual as a guide to install the ControlLogix™ Multi-Vendor Interface Module. The following table identifies what this manual contains and where to find specific information.

Topic	See Page
European Communities (EC) Directive Compliance	3
Preventing Electrostatic Discharge	4
Identify Module Components	5
Prepare the Chassis for Module Installation	6
Identify Module Features	6
Set the Configuration Jumpers	7
Determine Module Slot Location	9
Install the Module in the Chassis	10
Remove or Replace the Module (when applicable)	11
Installing or Removing the Module While Power Is Applied	12
Install the Serial Adapter Cables	12
Apply Chassis Power	14
Check Power Supply and Module Status	14
Reading the Status Indicators	15
Perform a Quick Start	16
Connect the Console	16
Configure the Module	16
Test the Module	18
Specifications	19
CUL Hazardous Location Approval	20

Throughout this manual we use the following note to make you aware of safety considerations:

ATTENTION



Identifies information about practices or circumstances that can lead to personal injury or death, property damage or economic loss.

Attention statements help you to:

- identify a hazard
- avoid a hazard
- recognize the consequences

We use the following note to call attention to critical information:

IMPORTANT

Identifies information that is critical for successful application and understanding of the product.

Allen-Bradley And ControlLogix are trademarks of Rockwell Automation.

European Communities (EC) Directive Compliance

If this product has the CE mark it is approved for installation within the European Union and EEA regions. It has been designed and tested to meet the following directives.

EMC Directive

This product is tested to meet the Council Directive 89/336/EC Electromagnetic Compatibility (EMC) by applying the following standards, in whole or in part, documented in a technical construction file:

- EN 50081-2 EMC — Generic Emission Standard, Part 2 — Industrial Environment
- EN 50082-2 EMC — Generic Immunity Standard, Part 2 — Industrial Environment

This product is intended for use in an industrial environment.

Low Voltage Directive

This product is tested to meet Council Directive 73/23/EEC Low Voltage, by applying the safety requirements of EN 61131-2 Programmable Controllers, Part 2 - Equipment Requirements and Tests. For specific information required by EN 61131-2, see the appropriate sections in this publication, as well as the Allen-Bradley publication Industrial Automation Wiring and Grounding Guidelines For Noise Immunity, publication 1770-4.1.

This equipment is classified as open equipment and must be mounted in an enclosure during operation to provide safety protection.

Preventing Electrostatic Discharge

The Multi-Vendor Interface module is sensitive to electrostatic discharge.

ATTENTION



This module is sensitive to electrostatic discharge. Electrostatic discharge can damage integrated circuits or semiconductors if you touch backplane connector pins. Follow these guidelines when you handle the module:

- Touch a grounded object to discharge static potential.
 - Wear an approved wrist-strap grounding device.
 - Do not touch the backplane connector or connector pins.
 - Do not touch circuit components inside the module.
 - If available, use a static-safe work station.
 - When not in use, keep the module in its static-shield bag.
-

Identify Module Components

The 1756-MVI module is shipped with the following six components:

- 1 - 1756-MVI Module
- 3 - Serial Adapter Cables
- 1 - 1756-MVI Installation Instructions
- 1 - CD ROM (1756-MVID only)

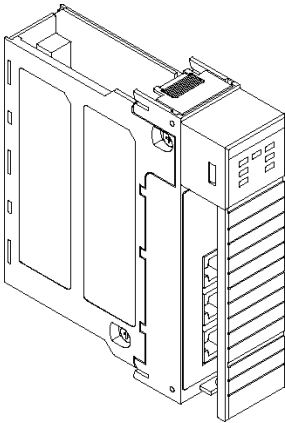

1756-MVI Module

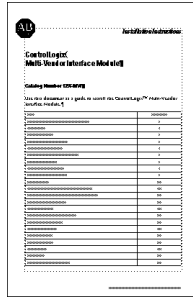

1756-MVI Installation Instructions

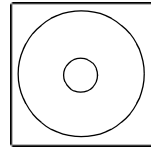

CD ROM
(1756-MVID only)

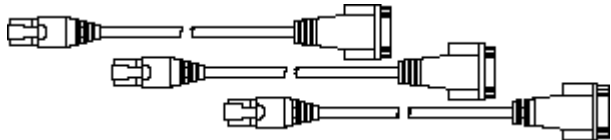

Serial Adapter Cables

Check your order to make sure that you received all of these components. If you did not receive all of these components, contact your local Allen-Bradley representative.

Prepare the Chassis for Module Installation

Before you install the MVI module, you must install and connect a ControlLogix chassis (1756-A4, 1756-A7, 1756-A10, or 1756-A13) and power supply (1756-PA72 or 1756-PB72). To install these products, refer to publications 1756-5.1 and 1756-5.2.

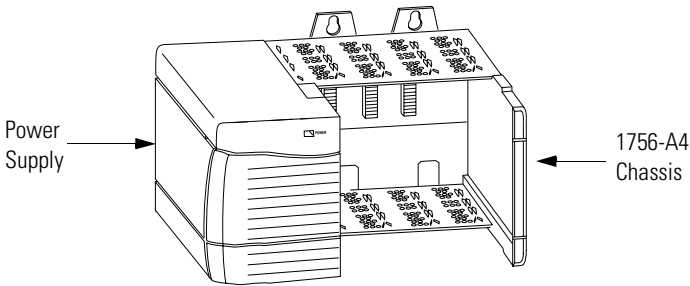

Identify Module Features

Use the figure below to identify the external features of the module.

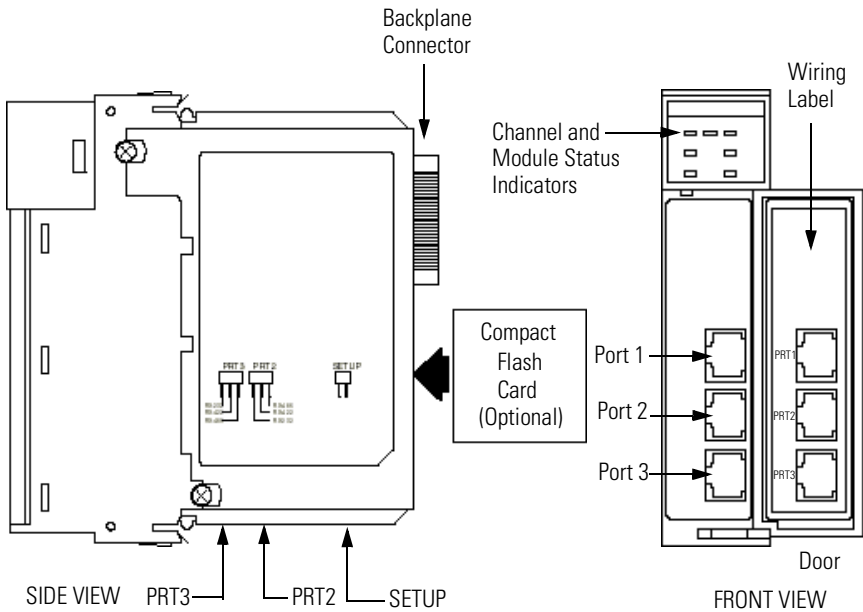

NOTE: Jumpers are located on the back of circuit board when viewed from this side.

Set the Configuration Jumpers

Before installing the 1756-MVI module in the chassis, set the module's configuration jumpers on the module's printed circuit board.

1. The module ships with the Setup jumper in the Setup position (see the figure on the following page). The Setup jumper causes the module to boot with console port PRT1 enabled at 19200 baud, no parity, 8 data bits and 1 stop bit.

Note: When the Setup jumper is removed, the module will boot with the configuration set in the BIOS Setup Menu. This configuration is described in detail in the Quick Start section of this manual. See "Configure the Manual" on page 16.

2. To enable communications on Port 2 and Port 3, place a jumper in the RS232, RS422, or RS485 position for each port. The module ships with the jumpers in the RS232 position (default).

The configuration jumper positions are shown in the following figure.

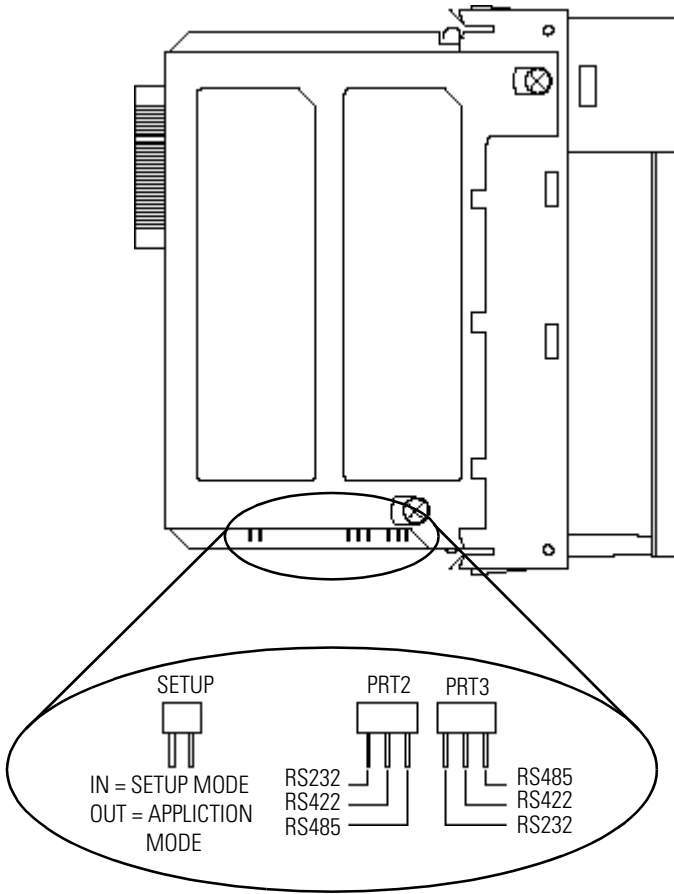

Determine Module Slot Location

You can install the module in any slot in the ControlLogix chassis. You can also install multiple MVI modules in the same chassis. The figure below shows chassis slot numbering in a 4-slot chassis. Slot 0 is the first slot and is always the leftmost slot in the rack (the first slot to the right of the power supply).

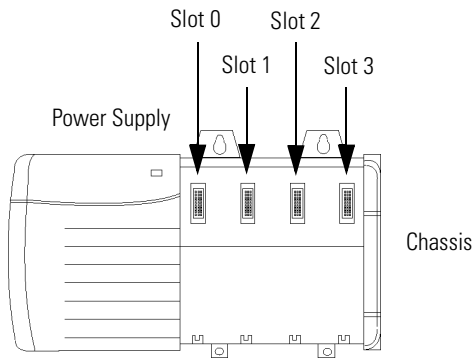

Install the Module in the Chassis

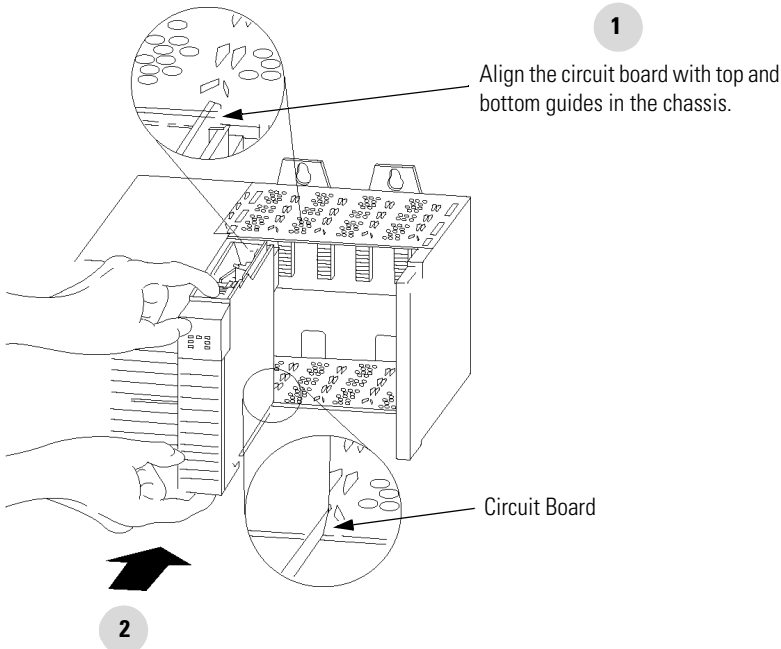

Slide the module into the chassis. Make sure the module backplane connector properly connects to the chassis backplane.

3

The module is properly installed when it is flush with the power supply or other installed modules.

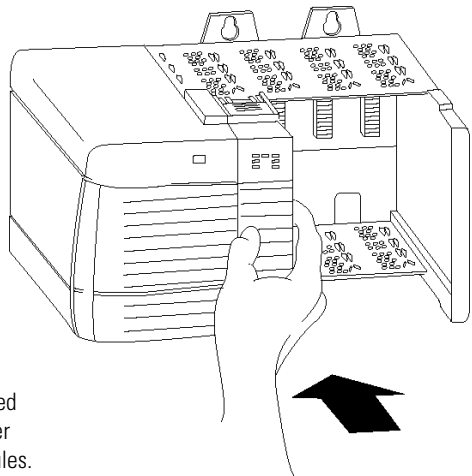

Remove or Replace the Module (when applicable)

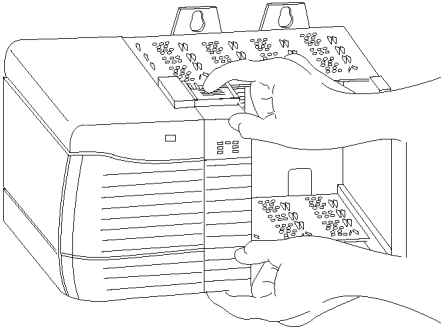

1

Push on upper and lower module tabs to disengage them.

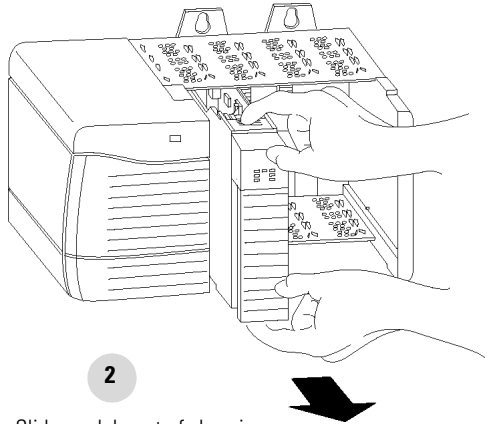

2

Slide module out of chassis.

IMPORTANT

If you are replacing an existing module with an identical one, and you want to resume identical system operation, you must install the new module in the same slot.

Installing or Removing the Module While Power Is Applied

You can install or remove the module while chassis power is applied.

ATTENTION



When you insert or remove a module while backplane power is on, an electrical arc may occur. An electrical arc can cause personal injury or property damage by:

- sending an erroneous signal to your system's actuators causing unintended machine motion or loss of process control.
- causing an explosion in a hazardous environment.

Repeated electrical arcing causes excessive wear to contacts on both the module and its mating connector. Worn contacts may create electrical resistance that can affect module operation.

Install the Serial Adapter Cables

Three identical serial adapter cables are supplied. Each cable has a locking-type RJ45 plug on one end and a DB-9 male connector on the other end. Insert the RJ45 connector on each cable into the RJ45 receptacles marked PRT1, PRT2, and PRT3 on the module.

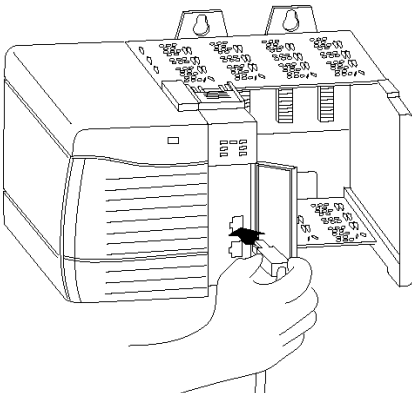

To install the locking-type RJ45 connector, slide the plug into the receptacle. The locking mechanism prevents the cable from being removed during normal operation. To remove the cable, press the locking tab and remove the plug.

Refer to the following tables to identify the signals on each of the 1756-MVI module's ports.

PRT1 Signals

DB-9M Pin	RS-232 Signal
1	DCD
2	RxD
3	TxD
4	DTR
5	COM/GND
6	DSR
7	RTS
8	CTS
9	--
Metal Shell	Shield

IMPORTANT

The cable length for PRT1 must not exceed ten (10) feet.

PRT2, PRT3 Signals

DB-9M Pin	Jumper Set to RS-232 Signal	Jumper Set to RS-422 Signal	Jumper Set to RS-485 Signal
1	DCD	TxD+	TxD/RxD+
2	RxD	RxD+	--
3	TxD	--	--
4	DTR	--	--
5	COM/GND	COM/GND	COM/GND
6	DSR	RxD-	--
7	RTS	--	--
8	CTS	TxD-	TxD/RxD-
9	--	--	--
Metal Shell	Shield	Shield	Shield

IMPORTANT

The cable length for PRT2 and PRT3 must not exceed:

- 50 feet for RS-232 signals
- 4000 feet for RS-422 and RS-485 signals

Apply Chassis Power

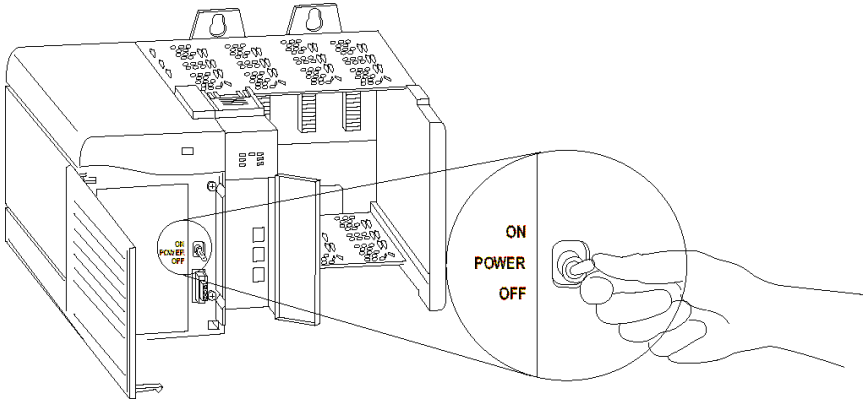

Check Power Supply and Module Status

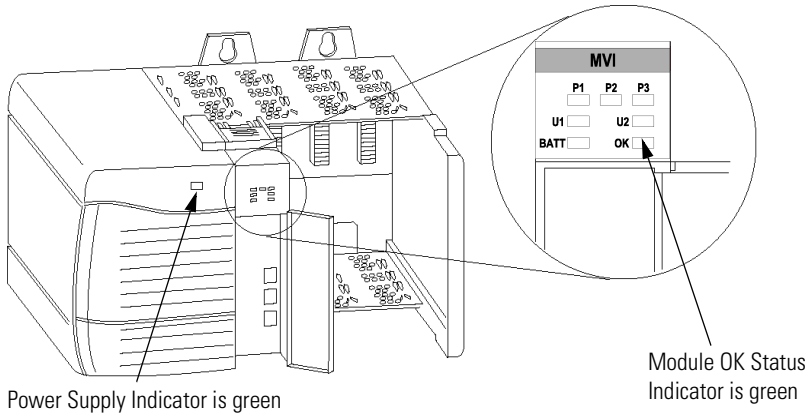

Reading the Status Indicators

LED Identification

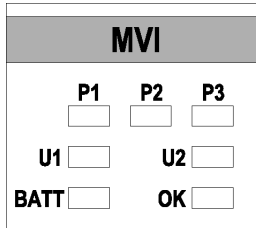

LED	Description	Status	Meaning
P1, P2, P3	Port Activity	Off	No serial activity detected on corresponding port.
		Green	Serial activity detected on corresponding port.
U1, U2	User Defined	-	Application dependent
BATT	Battery	Off	Battery voltage normal.
		Red	Battery voltage low. Service required.
OK ⁽¹⁾	Module Status	Green	Power is ON. Normal Operation
		Off	Power is OFF or module is not installed.
		Red	Module has failed. Service required.

⁽¹⁾ Defaults shown. The OK LED can also signify Status determined by the user-programmable "SetModuleStatus" command. Note that the SetModuleStatus command overrides the hardware defaults.

Perform a Quick Start

This section provides a quick overview of the steps necessary to configure the 1756-MVI module.

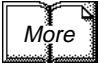

Note that this information is not meant to be comprehensive. For more detail, refer to the 1756-MVI Programming Reference Manual, publication 1756-RM004A-EN-P.

Connect the Console

1. Place the Setup jumper in the setup position as described on page 7.
2. Connect a terminal using terminal communication software (e.g., Hyperterminal) to the MVI module's console port, PRT1. This is an RS232 DTE port, which requires a null-modem cable to connect to a PC serial port.
3. Configure the console terminal for 19200 baud, 8 bits, 1 stop bit, no parity. Configure the terminal emulation mode as ANSI or VT100.
4. Turn on the power to the MVI module. The MVI module includes an embedded BIOS and DOS-compatible operating system. The boot messages should appear on the console. If no messages are seen, check to be sure the Setup jumper is installed and that the cable connections are correct.

Configure the Module

The embedded BIOS initializes the module and allows you to configure the module using the BIOS Setup Menu.

1. To enter the **Setup Menu**, press **Ctrl-C** on the console terminal when prompted. (If the module has already booted, type "reboot" at the prompt.)

You will see the **BIOS Setup Main Menu**:

```
System Bios Setup - Utility v4.001
(C) 1998 General Software, Inc. All rights reserved
-----
MVI Module Configuration
Begin Flash ROM Update Mode
Reset Configuration to Factory Default
Exit
-----
<Esc> to continue
```

2. Press the **Tab** key to move between menu choices. Press **Enter** to select a choice.
3. Choose **MVI Module Configuration** to configure the module type and console. The **MVI Module Configuration Menu** will open.

```
System BIOS Setup - Custom Configuration
(C) 1998 General Software, Inc. All rights reserved
-----
Console on Port 1 >Disabled      Compact Flash   Disabled
Console Baud Rate  19200
-----
^E/^X/<Tab> to select or +/- to modify
<Esc> to return to main menu
```

4. Use the **Tab** key to move between menu items and the **+** and **-** keys to change an item.

IMPORTANT

The configuration set with the MVI Module Configuration Menu is enabled only when the Setup jumper is not installed. If the Setup jumper is installed, the MVI console port is configured at 19200 baud, no parity, 8 data bits, and 1 stop bit.



Note that if “Console on Port 1” is Enabled and “Console Baud Rate” is 19200 baud, the module acts the same as if the Setup jumper is in place.

5. If a Compact Flash card has been installed, change the “Compact Flash” setting to **Enabled**. The Compact Flash card will act as drive C:\.
6. Press **Esc** to exit the Setup Menu.

Test the Module

The module should boot to the DOS command prompt, **A>**. Type “dir” to display the contents of the ROM disk.

Specifications

Type	Specifications
Module Location	Any slot in the ControlLogix chassis
Maximum Backplane Current Load	800mA @ 5.1V DC 3mA @ 24V DC from I/O chassis to ground
Power Dissipation	4W
Environmental Conditions: Operating Temperature Storage Temperature Relative Humidity	0 to 60° C (32 to 140° F) -40 to 85° C (-40 to 185° F) 5 to 95%, non-condensing
Shock (Unpackaged)	30g operational 50g non-operational
Vibration (Unpackaged)	2g from 10 to 500 Hz
Agency Certification (when product is marked):	  Marked for all applicable directives  Marked for all applicable acts N223
Installation Instructions	1756-IN001A-US-P

CUL Hazardous Location Approval

CUL certifies products for general use as well as for use in hazardous locations. Actual CUL certification is indicated by the product label as shown below, and not by statements in any user documentation.

Example of the CUL certification product label:



CL I, DIV 2
GP A,B,C,D
TEMP



To comply with CUL certification for use in hazardous locations, the following information becomes a part of the product literature for this CUL-certified industrial control product.

- This equipment is suitable for use in Class I, Division 2, Groups A, B, C, D, or non-hazardous locations only.
- The products having the appropriate CUL markings (that is, Class I, Division 2, Groups A, B, C, D) are certified for use in other equipment where the suitability of combination (that is, application or use) is determined by the CUL or the local inspection office having jurisdiction

IMPORTANT

Due to the modular nature of a programmable control system, the product with the highest temperature rating determines the overall temperature code rating of a programmable control system in a Class I, Division 2, location. The temperature code rating is marked on the product label as shown.

Temperature code rating

:



CL I, DIV 2
GP A,B,C,D
TEMP



Look for temperature code rating here.

The following warnings apply to products having CSA certification for use in hazardous locations:



WARNING: Explosion hazard—

- Substitution of components may impair suitability for Class I, Division 2.
- Do not replace components unless power has been switched off or the area is known to be non-hazardous.
- Do not disconnect equipment unless power has been switched off or the area is known to be non-hazardous.
- Do not disconnect connectors unless power has been switched off or the area is known to be non-hazardous. Secure any user-supplied connectors that mate to external circuits on this equipment by using screws, sliding latches, threaded connectors, or other means such that any connection can withstand a 15 Newton (3.4 lb.) separating force applied for a minimum of one minute.
- Batteries must only be changed in an area known to be non-hazardous.

CUL logo is a registered trademark of Underwriters Laboratories Inc.

Approbation d'utilisation dans des environnements dangereux par la CUL

La CUL certifie des produits pour une utilisation générale aussi bien que pour une utilisation en environnements dangereux. La certification CUL en vigueur est indiquée par l'étiquette produit et non par des indications dans la documentation utilisateur.

Exemple d'étiquette de certification d'un produit par la CUL:



CL I, DIV 2
GP A,B,C,D
TEMP

Pour satisfaire à la certification CUL en environnements dangereux, les informations suivantes font partie intégrante de la documentation des produits de commande industrielle certifiés.

- Cet équipement ne convient qu'à une utilisation dans des environnements de Classe 1, Division 2, Groupes A, B, C, D ou non dangereux.
- Les produits portant le marquage CUL approprié (c'est-à-dire Classe 1, Division 2, Groupes A, B, C, D) sont certifiés pour une utilisation avec d'autres équipements, les combinaisons d'applications et d'utilisation étant déterminées par la CUL ou le bureau local d'inspection

IMPORTANT

De par la nature modulaire des systèmes de commande programmables, le produit ayant le code de température le plus élevé détermine le code de température global du système dans un environnement de Classe I, Division 2. Le code de température est indiqué sur l'étiquette produit.

Code de température :



CL I, DIV 2
GP A,B,C,D
TEMP

Le code de température est indiqué ici.

Les avertissements suivants s'appliquent aux produits ayant la certification CUL pour une utilisation dans des environnements dangereux:

AVERTISSEMENT: Risque d'explosion—



- La substitution de composants peut rendre ce matériel inadapté à une utilisation en environnement de Classe 1, Division 2.
- Couper le courant ou s'assurer que l'environnement est classé non dangereux avant de remplacer des composants.
- Couper le courant ou s'assurer que l'environnement est classé non dangereux avant de débrancher l'équipement.
- Couper le courant ou s'assurer que l'environnement est classé non dangereux avant de débrancher les connecteurs. Fixer tous les connecteurs fournis par l'utilisateur pour se brancher aux circuits externes de cet appareil à l'aide de vis, loquets coulissants, connecteurs filetés ou autres, de sorte que les connexions résistent à une force de séparation de 15 Newtons (1,5 kg - 3,4 lb.) appliquée pendant au moins une minute.
- S'assurer que l'environnement est classé non dangereux avant de changer les piles.

Le sigle CUL est une marque déposée de la Underwriters Laboratories Inc.

Reach us now at www.rockwellautomation.com

Wherever you need us, Rockwell Automation brings together leading brands in industrial automation including Allen-Bradley controls, Reliance Electric power transmission products, Dodge mechanical power transmission components, and Rockwell Software. Rockwell Automation's unique, flexible approach to helping customers achieve a competitive advantage is supported by thousands of authorized partners, distributors and system integrators around the world.

Americas Headquarters, 1201 South Second Street, Milwaukee, WI 53204, USA, Tel: (1) 414 382-2000, Fax: (1) 414 382-4444
European Headquarters SA/NV, avenue Herrmann Diebroux, 46, 1160 Brussels, Belgium, Tel: (32) 2 663 06 00, Fax: (32) 2 663 06 40
Asia Pacific Headquarters, 27/F Citicorp Centre, 18 Whitfield Road, Causeway Bay, Hong Kong, Tel: (852) 2887 4788, Fax: (852) 2508 1846



**Rockwell
Automation**

Publication 1756-IN001A-US-P - May 2000

PN 957236-58

© 2000 Rockwell International Corporation. Printed in the U.S.A.