



Installation Instructions

8 or 16 Axis SERCOS interface Module Series B

(Catalog Number 1756-M08SE and 1756-M16SE)

The 8 or 16 Axis SERCOS interface™ module mounts in a ControlLogix™ chassis and uses fiber optical connections for all field-side wiring.

Before you install your module you should have:

- installed and grounded a 1756 chassis and power supply.
- ordered and received the fiber optic cables for your application.

For:	See page:
Overview	3
Important User Information	3
Rockwell Automation Support	4
Compliance to the European Union Directive	7
Determining the Power Requirements	8
Identifying Module Components	8
Module Product Label	11
Installing the Module	11
Fiber Optic Transmission	13
Fiber Optic Cables	14
Cable Connector Handling and Maintenance	17
Supported Drives	18
Ring Topology	19
Checking the LED Indicators	20
Removing the Module from the Chassis	24
Module Specifications	25

Related Documentation

The following documents contain additional information concerning related Allen-Bradley products. To obtain a copy, contact your local Rockwell Automation office or distributor.

For:	Read This Document:	Publication Number
ControlLogix motion commands	<i>Motion Instruction Set Reference Manual</i>	1756-RM007
Information on setup and configuration	<i>ControlLogix Motion Module Setup and Configuration manual</i>	1756-UM006
Information on installation, wiring, and setup for the 1394C-SJTxx-D	<i>1394 SERCOS Interface Multi Axis Motion Control System</i>	1394C-5.20
Information on integrating the 1394 drive with SERCOS	<i>1394 SERCOS Integration Manual</i>	1394-IN024
Information on Ultra3000 installation	<i>Ultra3000 Hardware Installation Manual</i>	2098-IN003
Information on Kinetix 6000 Module installation	<i>Kinetix 6000 Module Installation Manual</i>	2094-IN004
Information on Kinetix 6000 installation	<i>Kinetix 6000 Installation Manual</i>	2094-IN001
Information on integrating the Kinetix 6000 with SERCOS	<i>Kinetix 6000 Integration Manual</i>	2094-IN002
Information on integrating the Ultra3000 with the 1756-M08SE	<i>Ultra3000 SERCOS Integration Manual</i>	2098-IN005
Information on use of the 8720MC High Performance Drive	<i>8720MC High Performance Drive User Manual</i>	8720MC-UM001

Overview

The 8 or 16 Axis SERCOS interface module serves as a link between the ControlLogix platform and intelligent drives. The communication link between the module and the drive(s) is via IEC/EN 61491 Serial Real-time COmmunication System (SERCOS) using fiber optic medium. Fiber optics assures reliable high speed data transmission with excellent noise immunity, improved performance, and elimination of interconnect wiring.

SERCOS is a real-time optical serial interface between the control unit and its associated drives to transmit periodic and non-periodic data. Its topology is that of a ring with one master and multiple slaves (axes). The 8 or 16 Axis SERCOS interface module serves as the interface between one ControlLogix processor and 1 to 8 axes for the 1756-M08SE and 1 to 16 axes for the 1756-M16SE operating in either position, velocity, or torque mode. The module has a programmable ring Cycle Period of 0.5ms, 1ms or 2ms depending on the number of axes and a ring Data Rate of 4 Mbaud or 8 Mbaud. The module is designed to meet ASA System specifications.

Important User Information

Due to the variety of uses for the product described in this publication, those responsible for the application and use of this card must satisfy themselves that all necessary steps have been taken to assure that each application and use meets all performance and safety requirements, including all applicable laws, regulation codes, and standards.

The illustrations, charts, sample programs, and layout examples shown in this manual are intended solely for purposes of example. Since there are many variables and requirements associated with any particular installation, Rockwell Automation does not assume responsibility or liability (to include intellectual property liability) for actual use based upon the examples shown in this publication.

Throughout this documentation we use notes to make you aware of safety considerations:

ATTENTION



Identifies information about practices or circumstances that can lead to personal injury or death, property damage, or economic loss.

Attention statements help to:

- Identify a hazard.
 - Avoid a hazard.
 - Recognize the consequences.
-

IMPORTANT

Identifies information that is critical for successful application and understanding of the product.

Rockwell Automation Support

Rockwell Automation offers support services worldwide, with over 75 Sales/Support Offices, 512 authorized Distributors and 260 authorized Systems Integrators located throughout the United States alone, plus our representatives in every major country in the world.

Technical Product Assistance

If you need to contact Rockwell Automation for technical assistance, please review the information in this manual first. Then call your local Rockwell Automation representative. For the quickest possible response, we recommend that you have the catalog numbers of your products available when you call. See the *Related Documentation* section of this chapter for the publication numbers of other manuals that can help with this product.

The Rockwell Automation Technical Support number is:

1-440-646-5800

On the Web

For information about Rockwell Automation, visit the following World Wide Web site:

<http://www.ab.com/>

Preventing Electrostatic Discharge

ATTENTION



Electrostatic discharge can damage this module if you touch the internal circuitry without taking precautions. Follow these guidelines when handling it:

- Touch a grounded object to discharge potential static.
- Wear an approved grounding wriststrap.

Do not touch circuit components inside the 8 or 16 Axis SERCOS interface module.

Removing and Inserting Under Power (RIUP)

ATTENTION



This module is designed so you can remove and insert it under backplane power and field-side power. When you remove or insert a module while field-side power is applied, you can cause an electrical arc. An electrical arc can cause personal injury or property damage because it can:

- Send an erroneous signal to your system field devices causing unintended machine motion or loss of control.
- Cause an explosion in a hazardous environment.

Repeated electrical arcing causes excessive wear to contacts on both the module and its mating connector. Worn contacts can create electrical resistance.

Compliance to the European Union Directive

If this product bears the CE marking, it is approved for installation within the European Union and EEA regions. It has been designed and tested to meet the following directives.

EMC Directive

This product is tested to meet Council Directive 89/336/EEC Electromagnetic Compatibility (EMC) and the following standards documented in a technical file:

- EN 50081-2 EMC - Generic Emission Standard, Part 2 - Industrial Environment
- EN 61000-6-2 EMC - Generic Immunity Standard, Industrial Environment

This product is intended for use in an industrial environment.

Low Voltage Directive

This product is tested to meet Council Directive 73/23/EEC Low Voltage, by applying the safety requirements of EN 61131-2 Programmable Controllers, Part 2 - Equipment Requirements and Test.

For specific information required by EN 61131-2, see the appropriate sections in this publication, as well as the following Rockwell Automation publications:

- Industrial Automation Wiring and Grounding Guidelines, publication 1770-4.1
- Automation Systems Catalog, publication B111

This equipment is classified as open equipment and must be installed (mounted) in an enclosure during operation as a means of providing safety protection.

Determining the Power Requirements

This module receives power from the 1756 chassis power supply and requires two sources of power: 600 mA at 5.1V and 2.5 mA at 24V from the backplane. Add this current to the requirements of all other modules in this chassis to prevent overloading the backplane power supply.

Identifying Module Components

The following diagrams provide two views of the module. The first diagram is a front view which shows the position and function of the LEDs and the icons for the receiver and transmitter. The second diagram is a side view which shows the position of the transmitter and receiver connectors. (The 1756-M16SE looks identical to the 1756-M08SE.)

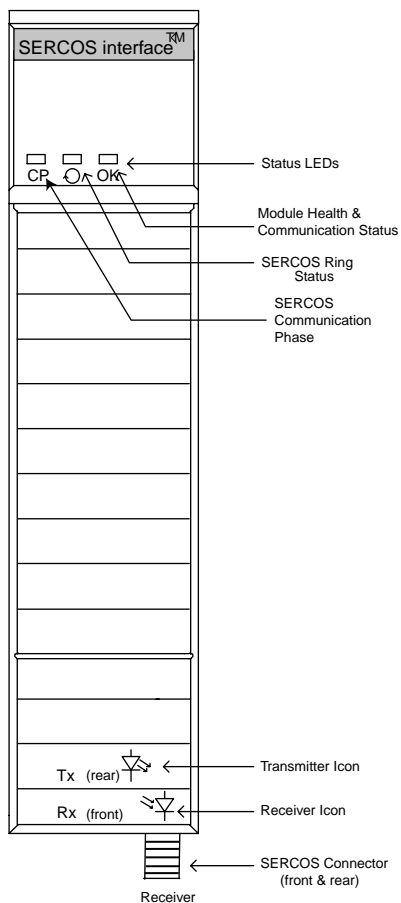

Figure 1 Front View of the Module

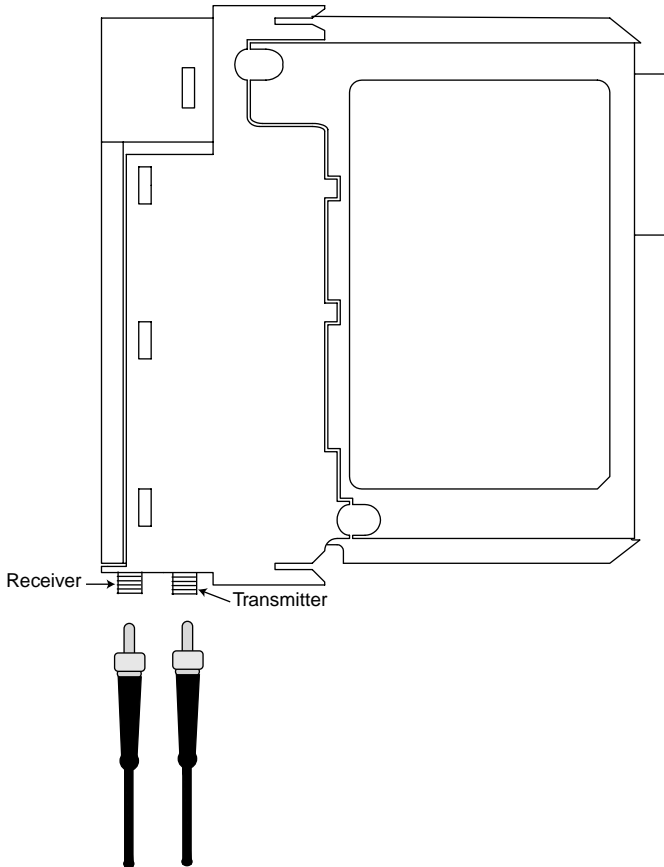

Figure 2 Side View of the Module Showing Fiber Optic Cable Connections

The end of the cable is inserted into the appropriate connector of the 1756-M08SE or 1756-M16SE. The threaded portion of the cable connector assembly fits over the module connector and is screwed on finger tight. Make sure that you remove the protector end caps before

attaching cable to the module. The end of the cable that emits light is the transmitter.

The Module's Product Label

The following figure shows the product label that is affixed to the side of the 1756-MxxSE module. This is a representation of the label and looks slightly different than the actual label. However, it does contain all of the same information.

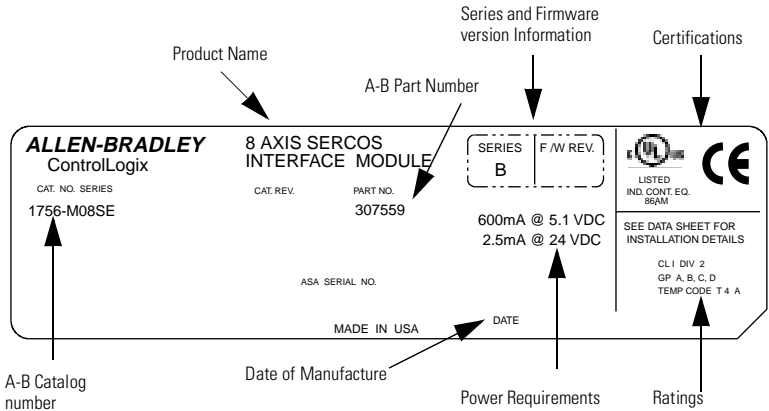

Figure 3 1756-MxxSE Product Label

Installing the Module

Please heed the following warnings before beginning to install the module.

ATTENTION



The power, input and output (I/O) wiring must be in accordance with Class I, Division 2, wiring methods, Article 501 4(b) of the National Electrical Code, NFPA 70 and in accordance with the authority having jurisdiction.

ATTENTION



Explosion Hazard -

- (A). Substitution of components may impair suitability for Class I, Division 2.
 - (B). When in a hazardous location, turn off power before replacing or wiring modules.
 - (C). Do not disconnect equipment unless power has been switched off or the area is known to be nonhazardous.
-

To install the 8 or 16 Axis SERCOS interface module:

1. Align the module circuit board with the top and bottom chassis guides

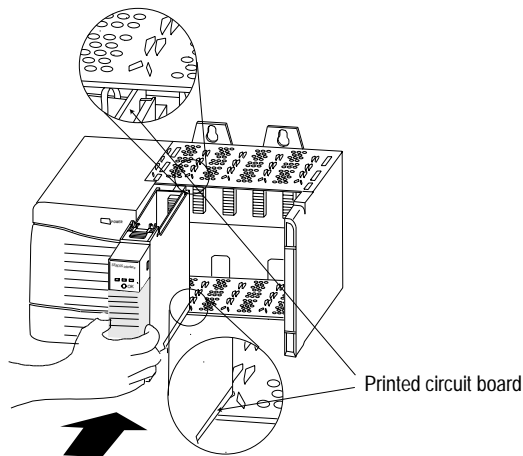

Figure 4 Align Module

2. Push evenly and firmly to seat the module in the chassis. It is seated when the top and bottom locking tabs have snapped into place.

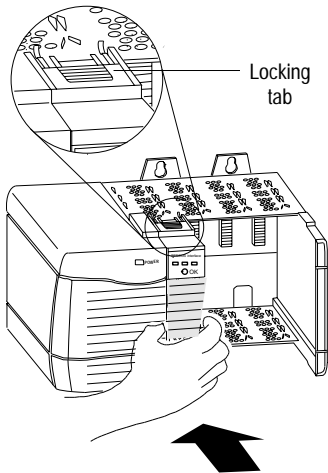

Figure 5 Seat the Module

Fiber Optic Transmission

The fiber optic transmitter for the SERCOS interface 8 or 16 Axis module uses a 650nm wavelength. This produces a visible light from the port and is a determinant in factoring maximum cable lengths. The high light output lets you use both plastic optical fiber (POF) and Hard Clad Silica (HCS[®]) cables.

The fiber optics used with the 1756-M08SE and 1756-M16SE modules are rated Class 1 for IEC Laser (LED) Safety Classification. Be aware that under certain conditions, viewing the optical port may expose the eye to hazard. Under most viewing conditions, there is no eye hazard.

ATTENTION



When viewed under some conditions, the optical port may expose the eye beyond the maximum permissible exposure recommended in ANSI Z136.2, 1993.

Fiber Optic Cables

The 1756-M08SE and the 1756-M16SE modules are connected to the drive(s) via a fiber optic cable. These cables can be either made of plastic or glass.

Plastic Fiber Optic Cables

The modules are connected to the drive(s) via a 1000 μ m plastic simplex fiber optical cable. Plastic fiber optic cables have a transmission range of 1 meter to 32 meters. Both the transmitter and receiver connections are made using a F-SMA standard plug that conforms to the F-SMA screw type connector.

Premade plastic fiber optic cable assemblies are available from Rockwell Automation. Plastic fiber optic cables come in a variety of jackets depending on application environments. The cable is available without a jacket (Chlorinated Polyethylene) for use inside an electrical cabinet, a standard jacket (Polyvinyl Chloride) for use outside of electrical cabinets, and a nylon jacket for use in harsh environments.

The following table shows the catalog numbers and available lengths for plastic fiber optic cables that are not jacketed (Chlorinated Polyethylene) and should be used only within an electrical cabinet.

Allen-Bradley Catalog Number	Length in meters (feet)
2090-SCEP1-0	1 m (3.28 ft)
2090-SCEP3-0	3 m (9.84 ft)
2090-SCEP5-0	5 m (16.26 ft)
2090-SCEP8-0	8 m (26.25 ft)
2090-SCEP10-0	10 m (32.81 ft)
2090-SCEP15-0	15 m (49.22 ft)
2090-SCEP20-0	20 m (65.62 ft)
2090-SCEP25-0	25 m (82.03 ft)
2090-SCEP32-0	32 m (104.99 ft)

The plastic fiber optic cables listed in the following table have a standard jacket (Polyvinyl Chloride) for use in normal environments outside of an electrical cabinet.

Allen-Bradley Catalog Number	Length in meters (feet)
2090-SCVP1-0	1 m (3.28 ft)
2090-SCVP3-0	3 m (9.84 ft)
2090-SCVP5-0	5 m (16.26 ft)
2090-SCVP8-0	8 m (26.25 ft)
2090-SCVP10-0	10 m (32.81 ft)
2090-SCVP15-0	15 m (49.22 ft)
2090-SCVP20-0	20 m (65.62 ft)
2090-SCVP25-0	25 m (82.03 ft)
2090-SCVP32-0	32 m (104.99 ft)

If your cables are going to run through a harsh environment, the cable should be appropriately jacketed. The following table contains

the catalog numbers and lengths for nylon jacketed cables for use in harsh environments.

Allen-Bradley Catalog Number	Length in meters (feet)
2090-SCNP1-0	1 m (3.28 ft)
2090-SCNP3-0	3 m (9.84 ft)
2090-SCNP5-0	5 m (16.26 ft)
2090-SCNP8-0	8 m (26.25 ft)
2090-SCNP10-0	10 m (32.81 ft)
2090-SCNP15-0	15 m (49.22 ft)
2090-SCNP20-0	20 m (65.62 ft)
2090-SCNP25-0	25 m (82.03 ft)
2090-SCNP32-0	32 m (104.99 ft)

Glass Fiber Optic Cables

Fiber Optic cables made from glass are a better conduit for the light to pass through thus increasing the length of cable that may be used and still supply a strong enough signal for use with the 1756-M08SE and 1756-M16SE modules.

The modules are connected to the drive(s) via a 200 μ m glass fiber optical cable. Glass fiber optic cables have a transmission range of 1 meter to 200 meters. Both the transmitter and receiver connections are made using a F-SMA standard plug that conforms to the F-SMA screw type connector.

Premade glass fiber optic cable assemblies are available from Rockwell Automation. Glass fiber optic cables come with a standard jacket (Polyvinyl Chloride) for use in normal environments.

The following table shows the catalog numbers and lengths available for premade glass fiber optic cables. These cables have a standard jacket (Polyvinyl Chloride) for use in normal environments.

Allen-Bradley Catalog Number	Length in meters (feet)
2090-SCVG1-0	1 m (3.28 ft)
2090-SCVG3-0	3 m (9.84 ft)
2090-SCVG5-0	5 m (16.26 ft)
2090-SCVG8-0	8 m (26.25 ft)
2090-SCVG10-0	10 m (32.81 ft)
2090-SCVG15-0	15 m (49.22 ft)
2090-SCVG20-0	20 m (65.62 ft)
2090-SCVG25-0	25 m (82.03 ft)
2090-SCVG32-0	32 m (104.99 ft)
2090-SCVG50-0	50m (164.05 ft)
2090-SCVG100-0	100m (328.1 ft)
2090-SCVG150-0	150m (492.15 ft)
2090-SCVG200-0	200m (656.2 ft)

Cable Connector Handling and Maintenance

When cables are not in use, keep the ends covered with the dust covers that came with the cables. This helps to keep dust and small particles from blocking the optic path. Good system performance is dependent on clean port optics and cable ferrules to avoid obstructing the optical path. Clean compressed air is often sufficient to remove particles of dirt. You can also use methanol on a cotton swab. Recommended cleaners include:

Alcohols

methy
isopropyl
isobutyl

Aliphatics

hexane
heptane

Other

soap solution
naphtha

ATTENTION

The small junction size inherent in the design of these components increases the components' susceptibility to damage from electrostatic discharge (ESD). It is advised that normal static precautions be taken in handling and assembly of these components to prevent damage and/or degradation which can be induced by ESD.

Supported Drives

The following Allen-Bradley drives are supported by the SERCOS interface motion modules.

Catalog Number	Description
1394-SJT05-D	1394 5kW SERCOS Interface 460V drive
1394-SJT10-D	1394 10kW SERCOS Interface 460V drive
1394-SJT22-D	1394 22kW SERCOS Interface 460V drive
2094-AC05-M01	Kinetix 6000™ 3kW Power Supply/10A Drive, 230VAC
2094-AC09-M02	Kinetix 6000 6kW Power Supply/15A Drive, 230VAC
2094-AM01	Kinetix 6000 10A Drive, 230VAC
2094-AM02	Kinetix 6000 15A Drive, 230VAC
2094-BC01-M01	Kinetix 6000 6kW Power Supply/10A Drive, 460VAC
2094-BC02-M02	Kinetix 6000 15kW Power Supply/17A Drive, 460VAC
2094-BM01	Kinetix 6000 10A Drive, 460VAC
2094-BM02	Kinetix 6000 17A Drive, 460VAC
2098-DSD-005-SE	Ultra3000™ 0.5kW SERCOS Interface 230V Drive
2098-DSD-010-SE	Ultra3000 1kW SERCOS Interface 230V Drive
2098-DSD-020-SE	Ultra3000 2kW SERCOS Interface 230V Drive

Catalog Number	Description
2098-DSD-030-SE	Ultra3000 3kW SERCOS Interface 230VDrive
2098-DSD-075-SE	Ultra3000 7.5kW SERCOS Interface 230VDrive
2098-DSD-150-SE	Ultra3000 15kW SERCOS Interface 230VDrive
2098-DSD-HV030-SE	Ultra3000 3kW, 460VAC SERCOS Interface 460V drive
2098-DSD-HV050-SE	Ultra3000 5kW, 460VAC SERCOS Interface 460V drive
2098-DSD-HV100-SE	Ultra3000 10kW, 460VAC SERCOS Interface 460V drive
2098-DSD-HV150-SE	Ultra3000 15kW, 460VAC SERCOS Interface 460V drive
2098-DSD-HV220-SE	Ultra3000 22kW, 460VAC SERCOS Interface 460V drive
8720MC	8720MC High Performance Drive

Ring Topology

The SERCOS network consists of a Master (1756-M08SE module or 1756-M16SE module) and multiple drives connected in a ring topology.

ATTENTION



Each drive on the SERCOS ring must have a unique SERCOS address. If two axes have the same address on the same ring, both respond to commanded motion. This could lead to damage to the equipment or product and could result in personal injury.

The fiber optical ring starts and ends with the master.

The following diagram gives an example of a possible network connected in a ring topology.

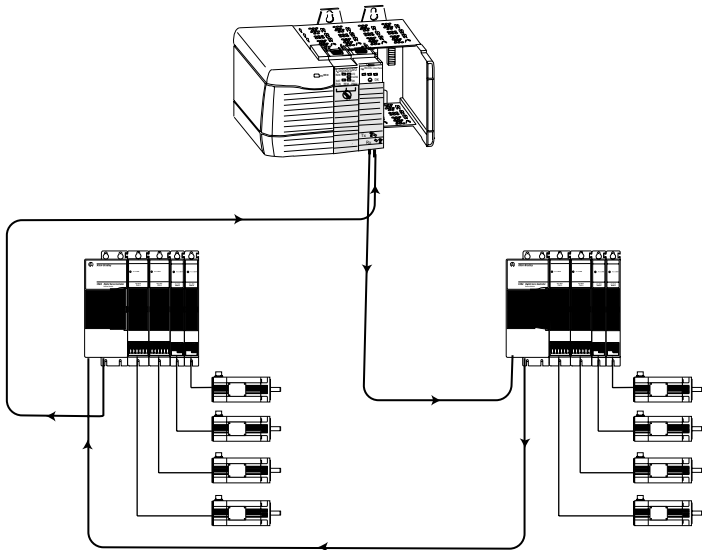

Figure 6 Ring topology with 1394C-SJTxx-D

Any break in the fiber optical ring disables the SERCOS network and creates a warning that is identified by the SERCOS Ring Status LED.

Checking the LED Indicators

The module provides three LED indicators to show the state of the system. The LEDs are located on the bezel of the 1756-M08SE and 1756-M16SE modules. The LED on the right, marked by OK, indicates the present health of the module and the communication status. To the immediate left of the OK LED is the SERCOS Ring LED. This is marked with a ring icon and displays the status of the SERCOS network. A third LED is situated on the far left and displays the status of the SERCOS Communication Phases. The CP LED is for informational purposes only.

The following diagram shows the positioning of the LEDs.

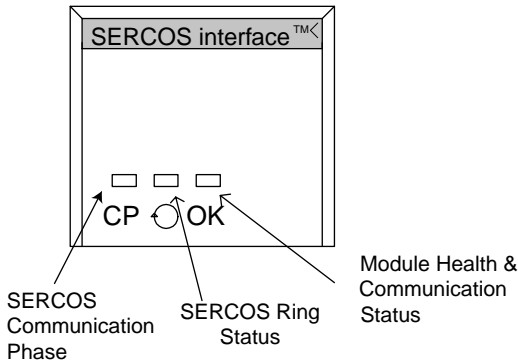

Figure 7 LED Location and Description

During power up, the module completes a self test that includes an indicator test. All LEDs go red for one second, green for one second, and off for one second.

SERCOS Communication Phase Status Using the CP Indicator

If the CP LED displays:	Then the module status is:
Solid Orange	<ul style="list-style-type: none"> In Phase -1: Autobaud detection in progress.
OFF	<ul style="list-style-type: none"> In Phase 0: looking for a closed ring.
Flashing Red	<ul style="list-style-type: none"> In Phase 1: looking for active nodes.
Alternating Red/Green	In Phase 2: configuring nodes for communication.
Flashing Green	In Phase 3: configuring device specific parameters
Solid Green	In Phase 4: configured and active.

Module Status Using the OK Indicator

If the OK LED displays:	Then the module status is:	Take this action:
Off	The module is not operating.	<ul style="list-style-type: none"> • Apply chassis power. • Verify the module is completely inserted into the chassis and backplane.
Flashing green	The module has passed internal diagnostics, but has not established active communications.	None, if you have not configured the module.
Solid green	<ul style="list-style-type: none"> • Data is being exchanged. • The module is in the normal operating state. 	None. The module is ready for action.
Flashing red	<ul style="list-style-type: none"> • A major recoverable failure has occurred. • An NVS update is in progress. 	If an NVS update is in progress, complete the NVS update. If an NVS update is not in progress: Reboot
Solid red	A potential nonrecoverable fault has occurred.	<ul style="list-style-type: none"> • Reboot the module. • If the solid red persists, replace the module.

SERCOS Ring Status

If the SERCOS Ring LED displays:	Then the ring status is:	Take this action:
Solid green	The ring, drive, and axes are configured and are actively communicating through to the nodes on the ring.	None.
Flashing red	The module has detected a setup or configuration fault with the ring.	Check your system setup and configuration as follows: <ul style="list-style-type: none"> • Ensure drive and axes addresses are correct. • Remove excess axes from ring. • Make sure application program has selected the proper Ring Cycle Period and Baud Rate.

If the SERCOS Ring LED displays:	Then the ring status is:	Take this action:
Solid red	The module has detected a hardware or installation fault with the ring.	Check your system hardware and installation as follows: <ul style="list-style-type: none"> • Make sure all cables are properly installed. • Make sure cable is of the correct type and length. • Make sure application program has configured the module's ring transmit level to High when using specified cables. • Make sure the drive's transmit levels are set appropriately. • Inspect cables for degradation. • Inspect drives for any faults and correct them.
Off	The module has detected no ring data on its receiver or has not successfully completed phase 2.	Check your system and installation as follows: <ul style="list-style-type: none"> • Make sure all cables are properly installed • Inspect cable for degradation and breakage. • Inspect drives for faults.
Flashing green	The ring, drive, or axes are not configured but, at least one has been identified.	Not a problem if the system has not been configured. If you are having trouble configuring the ring, drive, and axes: Make sure that the application program is setup properly for the equipment in use.

Removing the Module from the Chassis

To remove the module from the chassis:

1. Push in and hold the top and bottom locking tabs on the module.

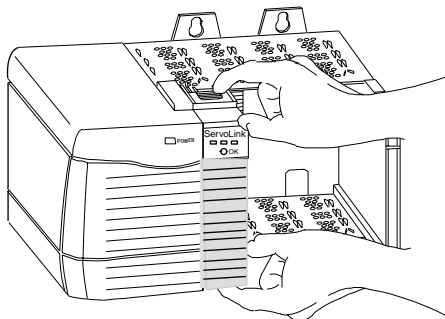

Figure 8 Hold locking Tabs

2. Pull the module out of the chassis.

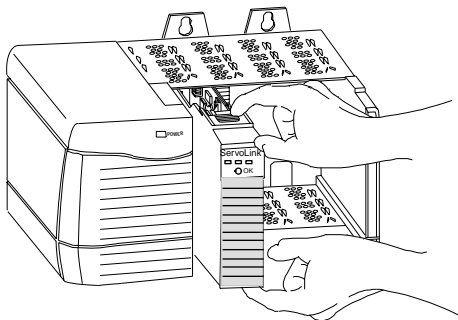



Figure 9 Pull Module Out

Module Specifications

Specification:	Description:
Number of Nodes	1756-M08SE – 8 axes maximum 1756-M16SE – 16 axes maximum
Module location	1756 ControlLogix chassis
Module keying	Electronic
Power dissipation	5.0W maximum
Backplane current	5.1V dc @ 900 mA 24V dc @ 2.5 mA
Environmental Specifications Operational Temperature Storage temperature Relative Humidity	0 to 60° C (32-140° F) -40 to 85°C (-40 to 185°F) 5 to 95% non condensing IEC 68-2-30
Shock Operating Non-operating	30g peak acceleration, 11(±2)ms pulse width 50g peak acceleration, 11(±2)ms pulse width
Vibration	2g @ 10-500Hz per IEC 68-2-6
Plastic Fiber Optic Specifications Transmission Range Core Diameter Cladding Diameter Cable Attenuation Operating Temperature Connector Bend Radius	1-32 meters 980µm ± 60µm 1000µm ± 60µm 140 dB/km @ 650nm -55 to 85° C F-SMA standard screw-type connector 2.5 cm
Glass Fiber Optic Specifications Transmission Range Core Diameter Cladding Diameter Cable Attenuation Operating Temperature Connector Bend Radius	1-200 meters 200µm ± 4µm 230µm +0/-10µm 6.0 dB/km @ 820nm -20 to 85° C F-SMA standard screw-type connector 2.5cm

26 8 or 16 Axis SERCOS interface Module Series B

<p>SERCOS</p> <p>SERCOS Class</p> <p>Data Rate</p> <p>Operating cycle</p> <p>1756-M08SE @ 4 Mb</p> <p>1756-M08SE @ 8 Mb</p> <p>1756-M16SE @ 4 Mb</p> <p>1756-M16SE @ 8 Mb</p>	<p>Class B (Position or Velocity)</p> <p>4 Mbits or 8 Mbits per second</p> <p>0.5 ms for up to 2 axes 1 ms for up to 4 axes 2 ms for up to 8 axes</p> <p>0.5 ms for up to 4 axes 1 ms for up to 8 axes</p> <p>0.5 ms for up to 2 axes 1 ms for up to 4 axes 2 ms for up to 8 axes No support for 9 to 16 axes</p> <p>0.5 ms for up to 4 axes 1 ms for up to 8 axes 2 ms for up to 16 axes</p>
<p>Agency certification (when product or packaging is marked)</p>	<p> UL US UL508 – Industrial Control Equipment</p> <p>UL1604 – Class I, Division 2, Groups A, E C, D Hazardous location</p> <p> CE marked for all applicable directives</p>

Notes:

ControlLogix is a trademark of Rockwell Automation.

Kinetix 6000 is a trademark of Rockwell Automation.

Ultr3000 is a trademark of Rockwell Automation

SERCOS interface is a trademark of the Interests Group SERCOS interface e.V. of Stuttgart, Germany.
Rockwell Automation is a member of the SERCOS NA.

Allen-Bradley is a registered trademark of Rockwell Automation.

For more information refer to our web site at: www.ab.com/motion

www.rockwellautomation.com

www.ab.com

Corporate Headquarters

Rockwell Automation, 777 East Wisconsin Avenue, Suite 1400, Milwaukee, WI, 53202-5302 USA, Tel: (1) 414.212.5200, Fax: (1) 414.22.5201

Headquarters for Allen-Bradley Products, Rockwell Software Products and Global Manufacturing Solutions

Americas: Rockwell Automation, 1201 South Second Street, Milwaukee, WI 53204-2496 USA, Tel: (1) 414.382.2000, Fax: (1) 414.382.4444

Europe: Rockwell Automation SA/NV, Vorstlaan/Boulevard du Souverain 36-BP 3A/B, 1170 Brussels, Belgium, Tel: (32) 2 663 0600, Fax: (32) 2 663 0640

Asia Pacific: Rockwell Automation, 27/F Citicorp Centre, 18 Whitfield Road, Causeway Bay, Hong Kong, Tel: (852) 2887 4788, Fax: (852) 2508 1846

Headquarters for Dodge and Reliance Electric Products

Americas: Rockwell Automation, 6040 Ponders Court, Greenville, SC 29615-4617 USA, Tel: (1) 864.297.4800, Fax: (1) 864.281.2433

Europe: Rockwell Automation, Brühlstraße 22, D-74834 Elztal-Dallau, Germany, Tel: (49) 6261 9410, Fax: (49) 6261 1774

Asia Pacific: Rockwell Automation, 55 Newton Road, #11-01/02 Revenue House, Singapore 307987, Tel: (65) 351 6723, Fax: (65) 355 1733

Allen-Bradley Industrial Motion Control Technical Support

Ultra, Servo Motors (MP, F, H, Y and N-Series) and Electro-Craft products: Tel: (1) 952.914.3990, Fax: (1) 952.942.3756, E-mail:

RAEPTechSupport@ra.rockwell.com

ControlLogix Motion, GMC, GML, S-Class, 1746, IMC and Creonix products: Tel: (1) 603.443.5419, Fax: (1) 603.448-5969, E-mail:

RALebTechSupport@ra.rockwell.com

CNC products: (1) 440.646.6800

1394, Servo Motors (1326), 8720, and other products: Tel: (1) 262.512.8176, Fax: (1) 262.512.8450, E-mail: Support@drives.ra.rockwell.com

For Europe: Tel: 44 1270 580142, Fax: 44 1270 580141, E-mail: Ctechnicalsupport@ra.rockwell.com