

Installation Instructions

ControlLogix Data Highway Plus-Remote I/O Communication Interface Module

Catalog Number 1756-DHRIO/E

Topic	Page
About the ControlLogix Data Highway Remote I/O Communication Interface Module	6
Prepare the Chassis for Module Installation	8
Set the Network Type and Node Address Switches	7
Determine Module Slot Location	9
Install or Remove the Module While Power Is Applied	9
Remove or Replace the Module (When Applicable)	11
Wire the Connectors for the Module Channels	12
Connect the Programming Terminal and DH+ or Remote I/O Network	13
Apply Chassis Power	13
Troubleshoot the Power Supply	15
Interpret the Alphanumeric Display	15
Configure Your 1756-DHRIO Module	18
Additional Resources	23

Important User Information

Solid state equipment has operational characteristics differing from those of electromechanical equipment. Safety Guidelines for the Application, Installation and Maintenance of Solid State Controls (Publication SGI-1.1 available from your local Rockwell Automation sales office or online at <http://literature.rockwellautomation.com>) describes some important differences between solid state equipment and hard-wired electromechanical devices. Because of this difference, and also because of the wide variety of uses for solid state equipment, all persons responsible for applying this equipment must satisfy themselves that each intended application of this equipment is acceptable.





In no event will Rockwell Automation, Inc. be responsible or liable for indirect or consequential damages resulting from the use or application of this equipment.

The examples and diagrams in this manual are included solely for illustrative purposes. Because of the many variables and requirements associated with any particular installation, Rockwell Automation, Inc. cannot assume responsibility or liability for actual use based on the examples and diagrams.

No patent liability is assumed by Rockwell Automation, Inc. with respect to use of information, circuits, equipment, or software described in this manual.

Reproduction of the contents of this manual, in whole or in part, without written permission of Rockwell Automation, Inc., is prohibited.

Throughout this manual, when necessary, we use notes to make you aware of safety considerations.

WARNING 	Identifies information about practices or circumstances that can cause an explosion in a hazardous environment, which may lead to personal injury or death, property damage, or economic loss.
IMPORTANT	Identifies information that is critical for successful application and understanding of the product.
ATTENTION 	Identifies information about practices or circumstances that can lead to personal injury or death, property damage, or economic loss. Attentions help you identify a hazard, avoid a hazard and recognize the consequences.
SHOCK HAZARD 	Labels may be on or inside the equipment (for example, drive or motor) to alert people that dangerous voltage may be present.
BURN HAZARD 	Labels may be on or inside the equipment (for example, drive or motor) to alert people that surfaces may reach dangerous temperatures.

Environment and Enclosure

ATTENTION

This equipment is intended for use in a Pollution Degree 2 industrial environment, in overvoltage Category II applications (as defined in IEC publication 60664-1), at altitudes up to 2000 meters (6562 ft) without derating.

This equipment is considered Group 1, Class A industrial equipment according to IEC/CISPR Publication 11. Without appropriate precautions, there may be potential difficulties ensuring electromagnetic compatibility in other environments due to conducted as well as radiated disturbance.

This equipment is supplied as open-type equipment. It must be mounted within an enclosure that is suitably designed for those specific environmental conditions that will be present and appropriately designed to prevent personal injury resulting from accessibility to live parts. The enclosure must have suitable flame-retardant properties to prevent or minimize the spread of flame, complying with a flame spread rating of 5VA, V2, V1, V0 (or equivalent) if non-metallic. The interior of the enclosure must be accessible only by the use of a tool. Subsequent sections of this publication may contain additional information regarding specific enclosure type ratings that are required to comply with certain product safety certifications.

In addition to this publication, see Industrial Automation Wiring and Grounding Guidelines, for additional installation requirements, Allen-Bradley publication 1770-4.1. NEMA Standards publication 250 and IEC publication 60529, as applicable, for explanations of the degrees of protection provided by different types of enclosure.

Prevent Electrostatic Discharge

ATTENTION

This equipment is sensitive to electrostatic discharge, which can cause internal damage and affect normal operation. Follow these guidelines when you handle this equipment:

- Touch a grounded object to discharge potential static.
 - Wear an approved grounding wriststrap.
 - Do not touch connectors or pins on component boards.
 - Do not touch circuit components inside the equipment.
 - Use a static-safe workstation, if available.
 - Store the equipment in appropriate static-safe packaging when not in use.
-

European Hazardous Location Approval

If you install the module in a European Zone 2 location, consider:

European Zone 2 Certification (The following applies when the product bears the Ex or EEx Marking)

This equipment is intended for use in potentially explosive atmospheres as defined by European Union Directive 94/9/EC.

The LCIE (Laboratoire Central des Industries Electriques) certifies that this equipment has been found to comply with the Essential Health and Safety Requirements relating to the design and construction of Category 3 equipment intended for use in potentially explosive atmospheres, given in Annex II to this Directive.

Compliance with the Essential Health and Safety Requirements has been assured by compliance with EN 60079-15.



WARNING



When using this product, also consider the following:

- This equipment is not resistant to sunlight or other sources of UV radiation.
 - This equipment must be installed in an enclosure providing at least IP54 protection when applied in Zone 2 environments.
 - This equipment shall be used within its specified ratings defined by Allen-Bradley.
 - Provision shall be made to prevent the rated voltage from being exceeded by transient disturbances of more than 40% when applied in Zone 2 environments.
 - This equipment must be used only with ATEX certified backplanes.
 - Secure any external connections that mate to this equipment by using screws, sliding latches, threaded connectors, or other means provided with this product.
 - Do not disconnect equipment unless power has been removed or the area is known to be nonhazardous.
-

North American Hazardous Location Approval

<p>The following information applies when operating this equipment in hazardous locations:</p>	<p>Informations sur l'utilisation de cet équipement en environnements dangereux:</p>
<p>Products marked "CL I, DIV 2, GP A, B, C, D" are suitable for use in Class I Division 2 Groups A, B, C, D, Hazardous Locations and nonhazardous locations only. Each product is supplied with markings on the rating nameplate indicating the hazardous location temperature code. When combining products within a system, the most adverse temperature code (lowest "T" number) may be used to help determine the overall temperature code of the system. Combinations of equipment in your system are subject to investigation by the local Authority Having Jurisdiction at the time of installation.</p>	<p>Les produits marqués "CL I, DIV 2, GP A, B, C, D" ne conviennent qu'à une utilisation en environnements de Classe I Division 2 Groupes A, B, C, D dangereux et non dangereux. Chaque produit est livré avec des marquages sur sa plaque d'identification qui indiquent le code de température pour les environnements dangereux. Lorsque plusieurs produits sont combinés dans un système, le code de température le plus défavorable (code de température le plus faible) peut être utilisé pour déterminer le code de température global du système. Les combinaisons d'équipements dans le système sont sujettes à inspection par les autorités locales qualifiées au moment de l'installation.</p>
<p>WARNING</p> 	<p>EXPLOSION HAZARD -</p> <ul style="list-style-type: none"> Do not disconnect equipment unless power has been removed or the area is known to be nonhazardous. Do not disconnect connections to this equipment unless power has been removed or the area is known to be nonhazardous. Secure any external connections that mate to this equipment by using screws, sliding latches, threaded connectors, or other means provided with this product. Substitution of components may impair suitability for Class I, Division 2. If this product contains batteries, they must only be changed in an area known to be nonhazardous.
<p>AVERTISSEMENT</p> 	<p>RISQUE D'EXPLOSION –</p> <ul style="list-style-type: none"> Couper le courant ou s'assurer que l'environnement est classé non dangereux avant de débrancher l'équipement. Couper le courant ou s'assurer que l'environnement est classé non dangereux avant de débrancher les connecteurs. Fixer tous les connecteurs externes reliés à cet équipement à l'aide de vis, loquets coulissants, connecteurs filetés ou autres moyens fournis avec ce produit. La substitution de composants peut rendre cet équipement inadapté à une utilisation en environnement de Classe I, Division 2. S'assurer que l'environnement est classé non dangereux avant de changer les piles.

About the ControlLogix Data Highway Remote I/O Communication Interface Module

You can use the 1756-DHRIO module to communicate on a DH+ or remote I/O network.

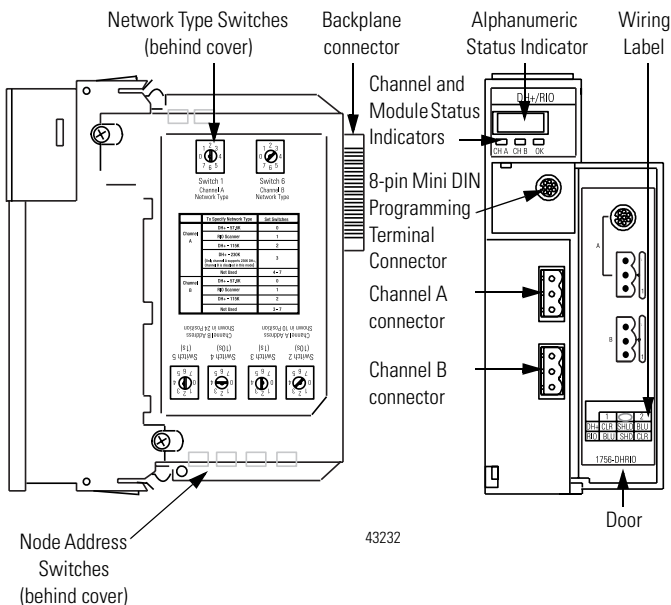

43232

Set the Network Type and Node Address Switches

Before you install the module, you must set the network type switches for each channel. If the network type is Data Highway Plus (DH+), you must also set the node address switches for that channel to a unique address within the range of 00-77.

IMPORTANT If your module uses the 230k DH+ network, that is, Channel A switch set to 3, Channel B is disabled.

Also, node address switches do not apply if you are using remote I/O.

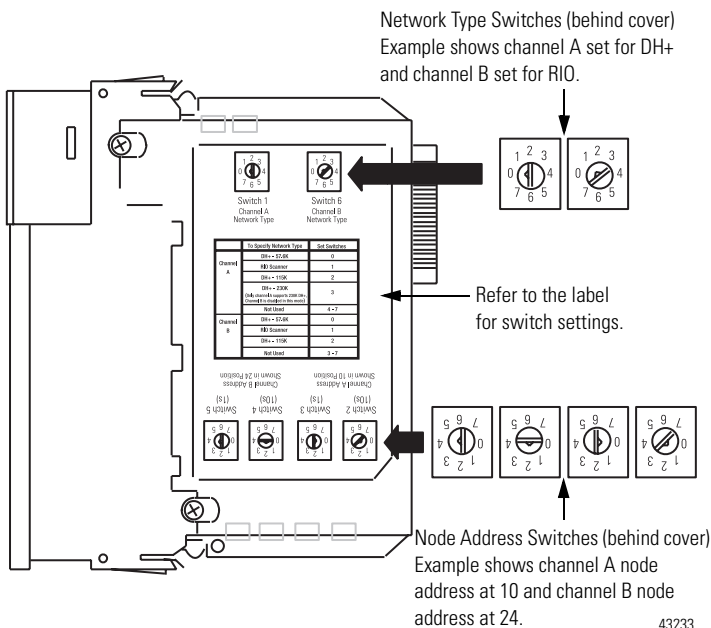

43233

Prepare the Chassis for Module Installation

Before you install the DHRIO module, you must install and connect a ControlLogix chassis and power supply.

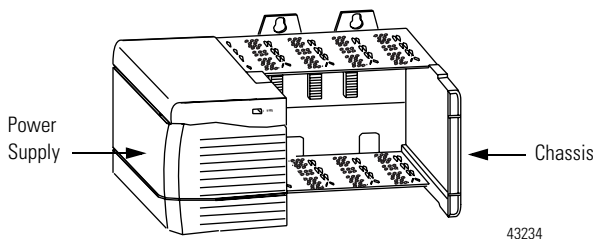

For information on installing these products, refer to the publications listed below.

Chassis and Power Supply Installation Documentation

Chassis Type	Chassis Installation	Power Supply	Power Supply Installation
Series B: 1756-A4, -A7, -A10, -A13, -A17	Pub. No. 1756-IN080	1756-PA72/B	Pub. No. 1756-IN078
		1756-PB72/B	
		1756-PA75/B	Pub. No. 1756-IN596
		1756-PB75/B	

Determine Module Slot Location

The figure below shows chassis slot numbering in a 4-slot chassis. Slot 0 is the first slot and is always the leftmost slot in the rack (the first slot to the right of the power supply). You can use any size ControlLogix chassis and install the module in any slot. You can also install multiple 1756-DHRIO modules in the same chassis. You can install as many modules as your power supply can accommodate, that is, number for which the power supply is rated.

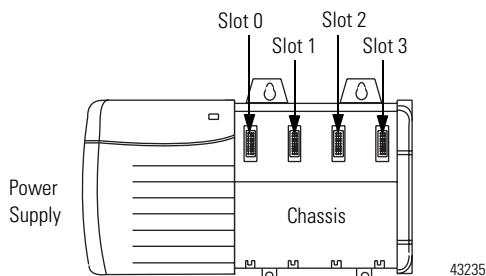

Install or Remove the Module While Power Is Applied

You can install or remove the module while chassis power is applied if you observe the following precautions.

WARNING

When you insert or remove the module while backplane power is on, an electrical arc can occur. This could cause an explosion in hazardous location installations.

Be sure that power is removed or the area is nonhazardous before proceeding. Repeated electrical arcing causes excessive wear to contacts on both the module and its mating connector. Worn contacts may create electrical resistance that can affect module operation.

Install the Module

ATTENTION



Do not force the module into the backplane connector. If you cannot seat the module with firm pressure, check the alignment. Forcing the module into the chassis can damage the backplane connector or the module.

1. Align the circuit board with top and bottom guides in the chassis.
2. Slide the module into the chassis. Make sure the module backplane connector properly connects to the chassis backplane.

The module is properly installed when it is flush with the power supply or other installed modules.

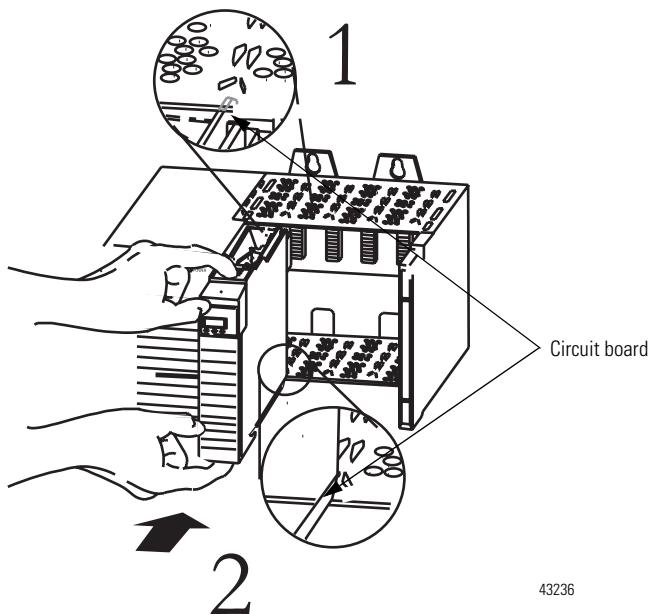

43236

Remove or Replace the Module (When Applicable)

1. Push on upper and lower module tabs to disengage them.
2. Slide the module out of the chassis.

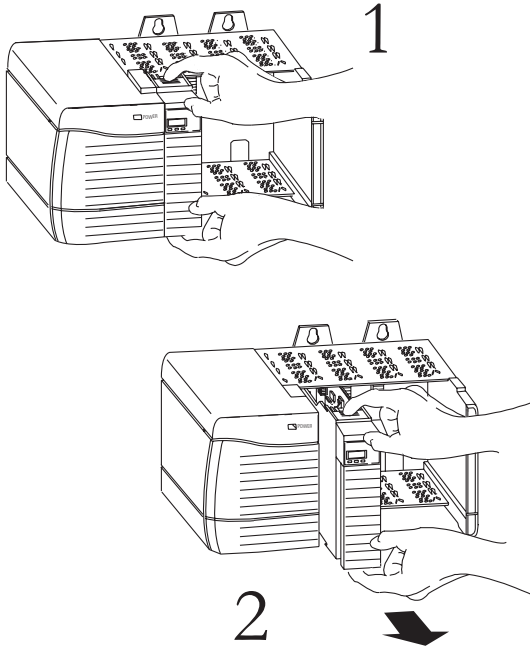

43237

If you are replacing an existing module with an identical one, and you want to resume identical system operation, you must install the new module in the same slot.

Wire the Connectors for the Module Channels

8-pin mini DIN programming terminal connection parallel to channel A when channel A is configured for DH+ communication.

Pin Assignments for 8-Pin DIN Connectors

Pin no	Desc
1	Blue
3	Shield
6	Clear

Pin Assignments for Channel A and B Connectors

DH+		Remote I/O	
Pin no	Desc	Pin no	Desc
1	Clear	1	Blue
	Shield		Shield
2	Blue	2	Clear

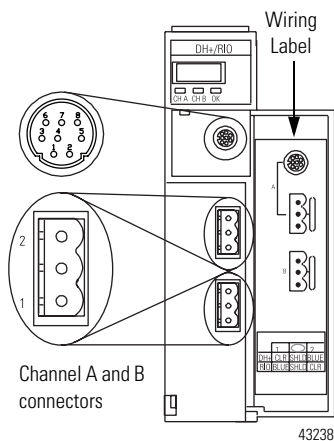

Data Highway +/-Remote I/O Communications Connections

WARNING



The local programming terminal port is intended for temporary use only and must not be connected or disconnected unless the area is assured to be nonhazardous.

If you connect or disconnect the communications connector with power applied to this module or any device on the network, an electrical arc can occur. This could cause an explosion in hazardous location installations.

Be sure that power is removed or the area is nonhazardous before proceeding.

Connect the Programming Terminal and DH+ or Remote I/O Network

1. Connect the programming terminal to the 8-pin mini DIN connector.
2. Connect the DH+ or Remote I/O network to the channel A or B connector as appropriate.

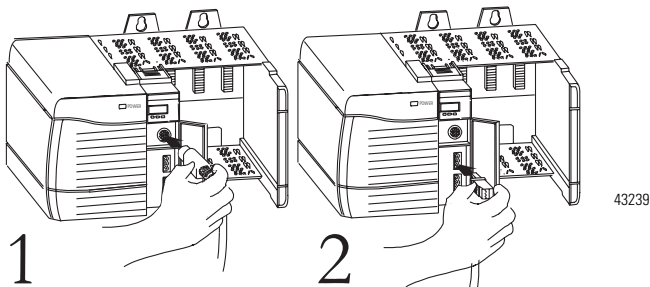

WARNING For hazardous locations, use the following cable for the programming terminal connection:



- Supplier: Huan Yu
- Part Number: GCMD08P050062000

Apply Chassis Power

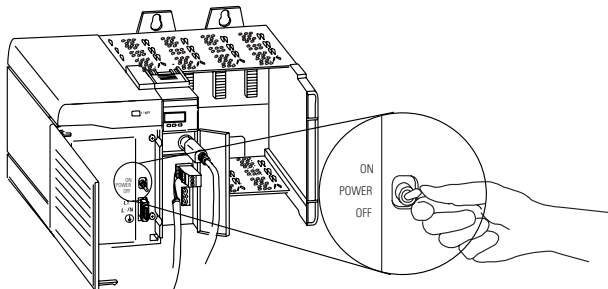

Check Power Supply and Module Status

Alphanumeric status indicator illuminates and cycles through a sequence of messages (described on page 15).

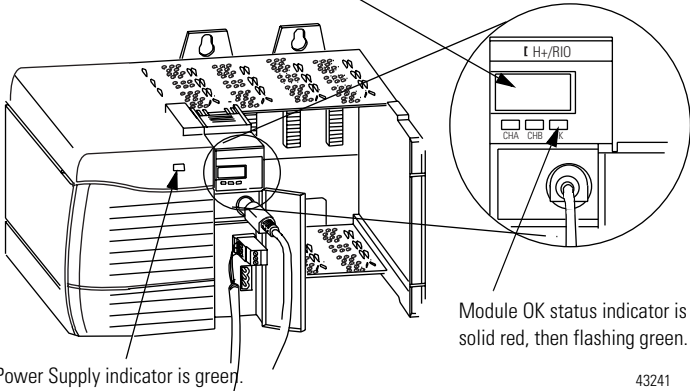

Power Supply indicator is green.

43241

Module OK status indicator is solid red, then flashing green.

At powerup the module's alphanumeric display begins a cycle through the following sequences.

- Channel A and the network used for channel A - DH+ or RIO
- Channel A node address, if used for DH+
- Channel A status
- Channel B and the network used for channel B - DH+ or RIO
- Channel B node address, if used for DH+
- Channel B status

This sequence runs continuously during normal module operation.

IMPORTANT For example, if your module uses the following:

- Channel A for DH+ with node address 14
- Channel B for RIO

and the channels are operating properly, you see the following sequence:

- A DH, A#14, A OK, B IO, SCAN, B OK

Troubleshoot the Power Supply

If the alphanumeric indicator on the 1756-DHRIO module does not cycle through these messages on powerup, refer to the following table and to the Troubleshooting section that follows.

If the POWER indicator is	Power Supply Status is	Recommended Action
Off	Not operating.	Turn power switch ON. Check power wiring connections. Check fuse.
On	Operating.	None, normal operation.

Interpret the Alphanumeric Display

Your 1756-DHRIO module displays alphanumeric codes that provide diagnostic information about your module. The alphanumeric display flashes the codes at approximately 1 second intervals. The following table summarizes the codes.

Code	Description	Recommended Action
Data Highway Plus		
OFF LINE	Data Highway Plus link is in STOP state.	Correct the configuration. Refer to the 1756-DHRIO User Manual, publication 1756-UM0514 .
DUPL NODE	Data Highway Plus Duplicate node address.	Choose another node address and reset switches.
ONLY NODE	Only node on Data Highway Plus link.	Check the cables.

16 ControlLogix Data Highway Plus-Remote I/O Communication Interface Module

Code	Description	Recommended Action
CNFG FALT	Incorrect DH+ routing table configuration. Incorrect Data Highway object configuration.	Correct the configuration. Refer to the 1756-DHRIO User Manual, publication 1756-UM0514 . Verify the module is inserted in correct slot.
Data Highway Plus		
OK	Normal operation for that channel.	None.
LINK OFF	Channel B is disabled because Channel A is used for 230k DH+ operation.	None
Remote I/O		
MUTE LINK	No adapters found on remote I/O.	Add an adapter to the remote I/O network.
RACK OVER	Rack overlap on remote I/O.	Reconfigure remote I/O racks.
DUPL SCAN	Duplicate scanner on remote I/O.	Check remote I/O adapter settings.
MAX_ DEV_	Maximum devices exceeded on remote I/O.	Remove devices to meet limitations on remote I/O network.
CHAT LINK	Babble detected on remote I/O.	Check remote I/O device and network connections.
OFF_ LINE	Not trying to communicate.	None. Normal state if controller is not controlling remote I/O.
OK	Normal operation	None.

Interpret the Status Indicators

The three status indicators on the module provide information about your module and the status of each channel. The following tables outline the indicator condition and the corresponding status, and explain what each condition means.

If the Module OK indicator is	Module Status	Recommended Action
Off	Not operating.	1. Apply chassis power. 2. Verify module is completely inserted into chassis and backplane.
Green flashing	Operating but not routing messages and no controller transferring I/O.	None, if no messages are actively being routed through the module and no controller transferring I/O. To route messages or transfer I/O, use module default configuration or configure module.
Red, then Off	Performing self-test.	None, normal operation.
Green	Operating and routing messages.	None, normal operation.
Red	In major fault	Reboot module. If red reoccurs, then replace module.
Red flashing	In major fault or configuration fault.	Check alphanumeric indicator and take action described in alphanumeric display message table on page 15.

If the channel A or B indicator is	in this channel mode	then the channel status is	take this action
Off	All	Not on line.	Place channel on line.
Green	RIO scanner	Active RIO link. All adapter modules are present and not faulted.	None, normal operation.
	DH+	Operating.	None, normal operation.
Green flashing	RIO scanner	One or more nodes faulted or failed.	Check power at other racks.
	DH+	No other node on the network.	Check cables.
Red	All	Hardware fault.	Reboot module. If red reoccurs, replace module.
Red flashing	RIO scanner	Faulted adapters detected.	Check cables. Check power at other racks.
	DH+	Duplicate node detected.	Check node address.

Configure Your 1756-DHRIO Module

After installing your 1756-DHRIO module, you must configure it. For more information, refer to the [Data Highway Plus-Remote I/O Communication Interface Module User Manual, publication 1756-UM514](#).

Specifications

ControlLogix Data Highway Plus-Remote I/O Communication Interface Module - 1756-DHRIO

Attribute	Value
Cat. No.	1756-DHRIO
Module Location	1756 ControlLogix chassis
Backplane Current (mA) at 24V	1.7 mA
Backplane Current (mA) at 5V	850 mA
Power Dissipation, Max.	4.5 W
Thermal Dissipation, Max.	15.4 BTU/hr
Baud Rate	57.6 Kbaud 115.2 Kbaud 230.4 Kbaud
Isolation voltage (continuous-voltage withstand rating)	30V (continuous), Basic Insulation Type Type tested at 877V DC for 60 s, DHRIO to system backplane
North American Temp Code	T4A
IEC Temp Code	T4
Enclosure Type Rating	None (open-style)
Conductors, Wire Size	Belden 9463 twinaxial 0.519mm ² (20 AWG)
Conductors, Category	2 ⁽¹⁾

⁽¹⁾ Use this conductor category information for planning conductor routing as described in system level installation manual. Also refer to [Industrial Automation Wiring and Grounding Guidelines, publication 1770-4.1.](#)

Environmental Specifications

Attribute	Value
Operating Temperature	IEC 60068-2-1 (Test Ad, Operating Cold), IEC 60068-2-2 (Test Bd, Operating Dry Heat), IEC 60068-2-14 (Test Nb, Operating Thermal Shock): 0...60 °C (32...140 °F)
Non-Operating Temperature	IEC 60068-2-1 (Test Ab, Unpackaged Non-operating Cold), IEC 60068-2-2 (Test Bb, Unpackaged Non-operating Dry Heat), IEC 60068-2-14 (Test Na, Unpackaged Non-operating Thermal Shock): -40...85 °C (-40...185 °F)
Relative Humidity	IEC 60068-2-30 (Test Db, Unpackaged Damp Heat): 5...95% noncondensing
Vibration	IEC 60068-2-6 (Test Fc, Operating): 2 g @ 10...500 Hz
Operating Shock	IEC 60068-2-27 (Test Ea, Unpackaged Shock): 30 g
Non-operating Shock	IEC 60068-2-27 (Test Ea, Unpackaged Shock): 50 g
Emissions	CISPR 11: Group 1, Class A
ESD Immunity	IEC 61000-4-2: 6 kV contact discharges 8 kV air discharges

Environmental Specifications

Attribute	Value
Radiated RF Immunity	IEC 61000-4-3: 10V/m with 1 kHz sine-wave 80% AM from 80...2000 MHz 10V/m with 200 Hz 50% Pulse 100% AM at 900 MHz 10V/m with 200 Hz 50% Pulse 100% AM at 1890 MHz 3V/m with 1 kHz sine-wave 80% AM from 2000...2700 MHz
EFT/B Immunity	IEC 61000-4-4: ±4 kV at 5 kHz on communications ports
Surge Transient Immunity	IEC 61000-4-5: ±2 kV line-earth(CM) on communications ports
Conducted RF Immunity	IEC 61000-4-6: 10V rms with 1 kHz sine-wave 80% AM from 150 kHz...80 MHz

Certifications

Certifications ⁽¹⁾ (when product is marked)	UL	UL Listed Industrial Control Equipment. See UL File E65584.
	c-UL-us	UL Listed Industrial Control Equipment, certified for US and Canada. See UL File E65584.
	c-UL-us	UL Listed for Class I, Division 2 Group A,B,C,D Hazardous Locations, certified for U.S. and Canada. See UL File E194810.
	CSA	CSA Certified Process Control Equipment. See CSA File LR54689C.
	CSA	CSA Certified Process Control Equipment for Class I, Division 2 Group A,B,C,D Hazardous Locations. See CSA File LR69960C.
	CE	European Union 2004/108/EC EMC Directive, compliant with: EN 61326-1; Meas./Control/Lab., Industrial Requirements EN 61000-6-2; Industrial Immunity EN 61000-6-4; Industrial Emissions EN 61131-2; Programmable Controllers (Clause 8, Zone A & B)
	C-Tick	Australian Radiocommunications Act, compliant with: AS/NZS CISPR 11; Industrial Emissions
EEx	European Union 94/9/EC ATEX Directive, compliant with: EN 60079-15; Potentially Explosive Atmospheres, Protection "n" (Zone 2)	

⁽¹⁾ See the Product Certification link at www.ab.com for Declarations of Conformity, Certificates, and other certification details.

Additional Resources

These documents contain additional information concerning related Rockwell Automation products.

Resource	Description
ControlLogix Data Highway Plus-Remote I/O Communication Interface Module user manual, publication 1756-UM514	Provides information about configuring, operating and troubleshooting the 1756-DHRIO module.
Industrial Automation Wiring and Grounding Guidelines, publication 1770-4.1	Provides general guidelines for installing a Rockwell Automation industrial system.
Product Certifications website, http://www.ab.com	Provides declarations of conformity, certificates, and other certification details.

You can view or download publications at <http://literature.rockwellautomation.com>. To order paper copies of technical documentation, contact your local Rockwell Automation distributor or sales representative.

Rockwell Automation Support

Rockwell Automation provides technical information on the Web to assist you in using its products. At <http://support.rockwellautomation.com>, you can find technical manuals, a knowledge base of FAQs, technical and application notes, sample code and links to software service packs, and a MySupport feature that you can customize to make the best use of these tools.

For an additional level of technical phone support for installation, configuration, and troubleshooting, we offer TechConnect support programs. For more information, contact your local distributor or Rockwell Automation representative, or visit <http://support.rockwellautomation.com>.

Installation Assistance

If you experience a problem within the first 24 hours of installation, please review the information that's contained in this manual. You can also contact a special Customer Support number for initial help in getting your product up and running.

United States	1.440.646.3434 Monday – Friday, 8 a.m. – 5 p.m. EST
Outside United States	Please contact your local Rockwell Automation representative for any technical support issues.

New Product Satisfaction Return

Rockwell Automation tests all of its products to ensure that they are fully operational when shipped from the manufacturing facility. However, if your product is not functioning and needs to be returned, follow these procedures.

United States	Contact your distributor. You must provide a Customer Support case number (call the phone number above to obtain one) to your distributor in order to complete the return process.
Outside United States	Please contact your local Rockwell Automation representative for the return procedure.

ControlLogix, Data Highway, DH+, Rockwell Automation, and TechConnect are trademarks of Rockwell Automation, Inc.

Trademarks not belonging to Rockwell Automation are property of their respective companies.

www.rockwellautomation.com

Power, Control and Information Solutions Headquarters

Americas: Rockwell Automation, 1201 South Second Street, Milwaukee, WI 53204-2496 USA, Tel: (1) 414.382.2000, Fax: (1) 414.382.4444

Europe/Middle East/Africa: Rockwell Automation, Vorstlaan/Boulevard du Souverain 36, 1170 Brussels, Belgium, Tel: (32) 2 663 0800, Fax: (32) 2 663 0840

Publication 1756-IN003D-EN-P - July 2008

PN 26655

Supersedes Publication 1756-IN003C-EN-P - February 2005

Copyright © 2008 Rockwell Automation, Inc. All rights reserved. Printed in the U.S.A.