



## *Installation Instructions*

# ControlLogix DeviceNet Scanner Module

Catalog Number 1756-DNB

Use this manual as a guide to install the ControlLogix™ DeviceNet™ Scanner Module. The following table identifies what this manual contains and where to find specific information.

<b>Topic</b>	<b>See Page</b>
European Communities (EC) Directive Compliance	3
Preventing Electrostatic Discharge	4
Understand the Module's Software Features	5
Identify Module Components	6
Prepare to Install the Module	7
Installing or Removing the Module Under Power	8
Determine Module Slot Location	9
Install the Module	10
Remove or Replace the Module	11
Wire the DeviceNet Connector	12
Connect the Module to the DeviceNet Network	13
Apply Chassis Power	13
Using the Manual Configuration Pushbutton	14
Interpreting the Alphanumeric Display	16
Interpreting the LED Status Indicators	19
ControlLogix Controller Interface	21
Hazardous Location Information	25
Specifications	27

## 2 ControlLogix DeviceNet Scanner Module

---

Throughout this manual we use the following notes to make you aware of safety considerations:

---

### **WARNING**



Identifies information about practices or circumstances that have the potential to create an explosion hazard.

---

### **ATTENTION**



Identifies information about other practices or circumstances that can lead to personal injury or death, property damage or economic loss.

---

Warning and Attention statements help you to:

- identify a hazard
- avoid a hazard
- recognize the consequences

We use the following note to call attention to critical information:

---

### **IMPORTANT**

Identifies information that is critical for successful application and understanding of the product.

---

Change bars are used to indicate information that has changed or been added since the previous version of these instructions.

## European Communities (EC) Directive Compliance

If this product has the CE mark it is approved for installation within the European Union and EEA regions. It has been designed and tested to meet the following directives.

### EMC Directive

This product is tested to meet the Council Directive 89/336/EC Electromagnetic Compatibility (EMC) by applying the following standards, in whole or in part, documented in a technical construction file:

- EN 50081-2 EMC — Generic Emission Standard, Part 2 — Industrial Environment
- EN 50082-2 EMC — Generic Immunity Standard, Part 2 — Industrial Environment

This product is intended for use in an industrial environment.

### Low Voltage Directive

This product is tested to meet Council Directive 73/23/EEC Low Voltage, by applying the safety requirements of EN 61131-2 Programmable Controllers, Part 2 - Equipment Requirements and Tests.

For specific information required by EN 61131-2, see the appropriate sections in this publication, as well as the following Allen-Bradley publications:

- Industrial Automation Wiring and Grounding Guidelines, publication 1770-4.1
- Automation Systems Catalog, publication B113

Open style devices must be provided with environmental and safety protection by proper mounting in enclosures designed for specific application conditions. See NEMA Standards publication 250 and IEC publication 529, as applicable, for explanations of the degrees of protection provided by different types of enclosure.

### Enclosure and Environmental Requirements Specific To This Product

This product must be mounted within a suitable system enclosure to prevent personal injury resulting from accessibility to live parts. The interior of this enclosure must be accessible only by the use of a tool.

This industrial control equipment is intended to operate in a Pollution Degree 2 environment, in overvoltage category II applications, (as defined in IEC publication 664A) at altitudes up to 2000 meters without derating.

### Preventing Electrostatic Discharge

The DeviceNet scanner module is sensitive to electrostatic discharge.

---

#### ATTENTION



This module is sensitive to electrostatic discharge. Electrostatic discharge can damage integrated circuits or semiconductors if you touch backplane connector pins. Follow these guidelines when you handle the module:

- Touch a grounded object to discharge static potential.
  - Wear an approved wrist-strap grounding device.
  - Do not touch the backplane connector or connector pins.
  - Do not touch circuit components inside the module.
  - If available, use a static-safe work station.
  - When not in use, keep the module in its static-shield bag.
-

## Understand the Module's Software Features

The 1756-DNB module has the software features described in the following sections. You activate these features by using RSNetWorx for DeviceNet™ software (catalog no. 9357-DNETL3). For more information, refer to the appropriate RSNetWorx for DeviceNet documentation, and to the 1756-DNB Scanner User Manual, publication 1756-UM515C-EN-P.

### Slave Mode

The slave mode feature allows processor-to-processor communication. It does this by allowing the scanner to perform as a slave device to another master on the network.

Like other slaves, the scanner module exchanges data with only one master when it is in slave mode. You control what information is exchanged through the scan list configuration and associated mapping functions of RSNetWorx for DeviceNet software.

The 1756-DNB can function in the following modes:

Scanner is in this mode	when it
Null	contains an empty or disabled scan list (out-of-box default).
Master	serves as a master to one or more slaves but is not simultaneously serving as a slave to another master.
Slave	serves as a slave to another master.
Dual	serves as both a master to one or more slaves and as a slave to another master simultaneously.

### Change of State

The scanner module can send and receive data on a change of state basis with slave devices that also have this feature. Data is sent:

- whenever a data change occurs, or
- at a user-configurable heartbeat rate

Change of state increases system performance by reducing network traffic, since data is only sent on an as-needed basis. Use RSNetWorx for DeviceNet software to activate this feature.

### Cyclic I/O

The scanner module can send and receive data on a cyclic basis with slave devices that also have this feature.

Cyclic I/O increases system performance by reducing network traffic, since data is only sent at a user-configurable rate. Use RSNetWorx for DeviceNet software to activate this feature.

### Identify Module Components

Use the following figure to identify the external components of the module.

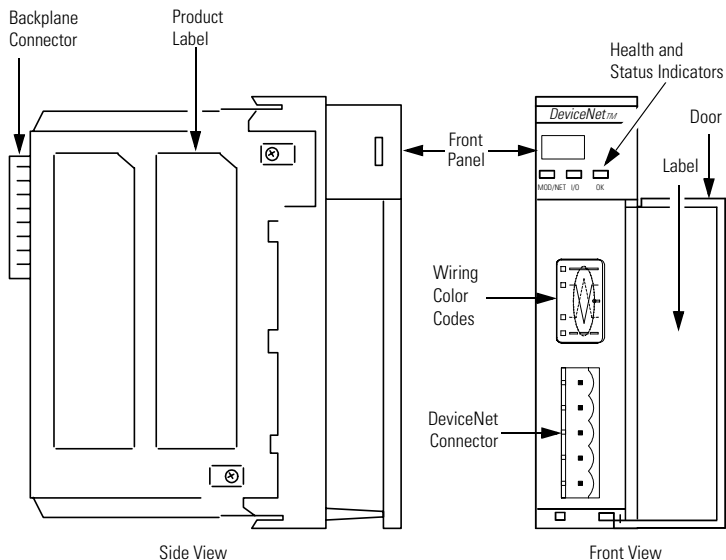

## Prepare to Install the Module

Before you install the module, make sure that you have these components.

1756-DNB module



1756-A4, 1756-A7, or 1756-A10 chassis

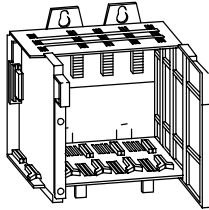

1756-PA72/75 or 1756-PB72/75 power supply

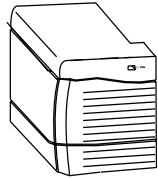

DeviceNet open-style or 10-position connector



small screwdriver



DeviceNet truck or drop cable

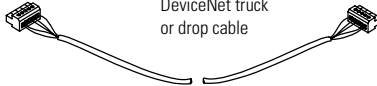

## Installing or Removing the Module Under Power

This module is designed to be installed or removed while chassis power is applied.

---

### WARNING



When you insert or remove a module while backplane power is on, an electrical arc may occur. An electrical arc can cause personal injury or property damage by:

- sending an erroneous signal to your system's field device causing unintended machine motion or loss of process control
- causing an explosion in a hazardous environment

Repeated electrical arcing causes excessive wear to contacts on both the module and its mating connector. Worn contacts may create electrical resistance that can affect module operation.

---

## Prepare the Chassis for Module Installation

Before you install the module, you must install and connect a ControlLogix chassis and power supply. A 4-slot chassis with a power supply is shown below.

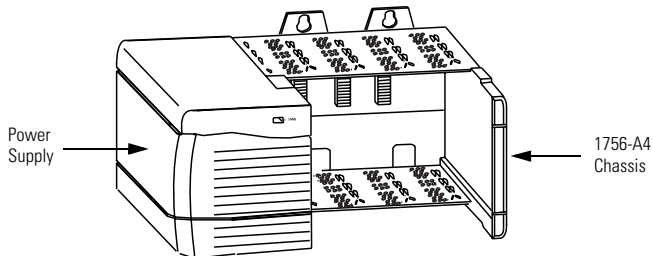



For information on installing these products, refer to the publications listed in the following table.

Chassis Type	Chassis Installation	Power Supply	Power Supply Installation
Series B: 1756-A4, -A7, -A10, -A13	Pub. No. 1756-IN080	1756-PA72/B	Pub. No. 1756-5.67
		1756-PB72/B	
		1756-PA75/A	Pub. No. 1756-5.78
		1756-PB75/A	

### Determine Module Slot Location

This figure shows chassis slot numbering in a 4-slot chassis. Slot 0 is the first slot and is always located to the right of the power supply. You can use any size ControlLogix chassis and install the module in any slot. You can also install multiple 1756-DNB modules in the same chassis. You can install as many modules as your power supply can accommodate (i.e., number for which the power supply is rated).

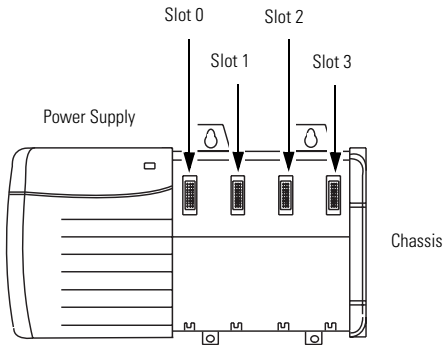

## Install the Module

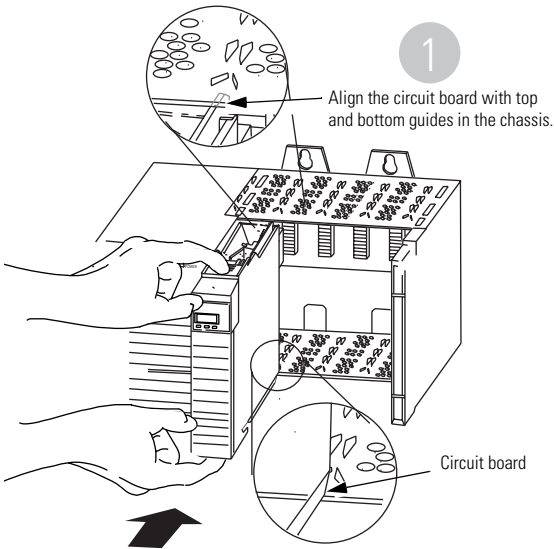

2

Slide the module into the chassis.  
Make sure the module properly connects  
to the chassis backplane.

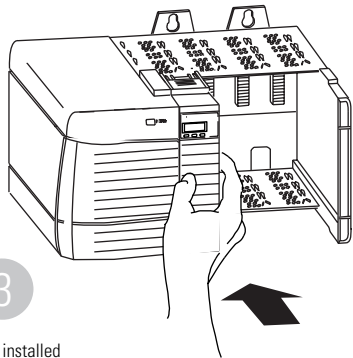

## Remove or Replace the Module

### IMPORTANT

If you are replacing an existing 1756-DNB module with another 1756-DNB module and you want to resume identical system operation, you must install the new module in the same slot.

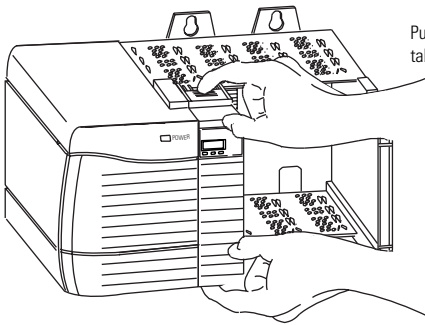

Push on upper and lower module tabs to disengage them.

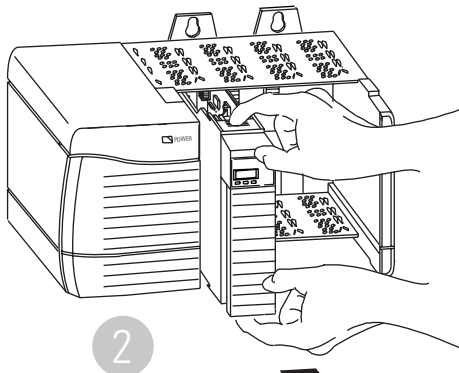

Slide the module out of the chassis.



## Wire the DeviceNet Connector

Use an open-style 5- or 10-position linear plug to connect to the DeviceNet network. An open-style 10-position linear plug is provided with your module.

### IMPORTANT

For detailed DeviceNet connection information, see the DeviceNet Cable System Planning and Installation Manual, publication DN-6.7.2. Also see the Industrial Automation Wiring and Grounding Guidelines, publication 1770-4.1.

Wire the connector according to the following illustrations.

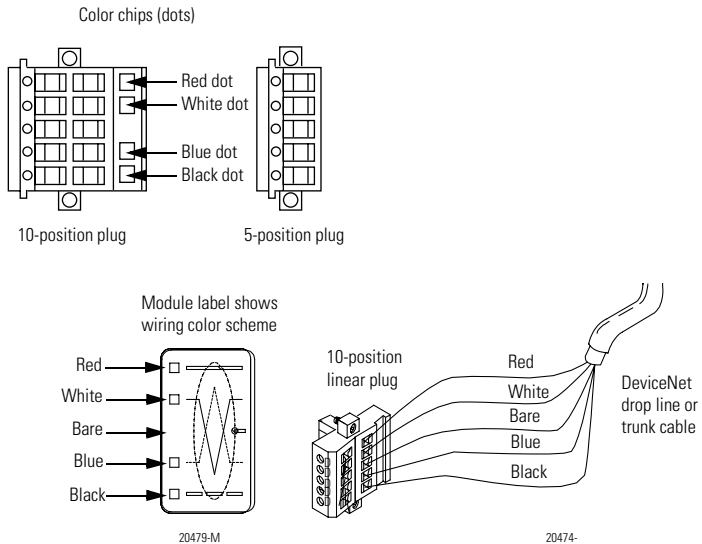

## Connect the Module to the DeviceNet Network

Attach the connector to the module's DeviceNet port as shown below. Tighten the screws on the connector as needed.

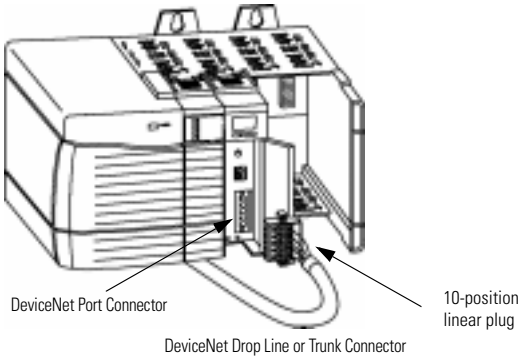

## Apply Chassis Power

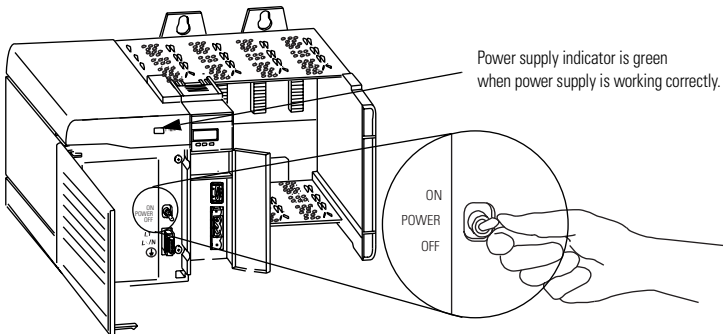

## Check the Module Alphanumeric Display on Power-up

Check the module alphanumeric display to determine if the module is operating. When you apply chassis power, the alphanumeric display cycles through the following information:

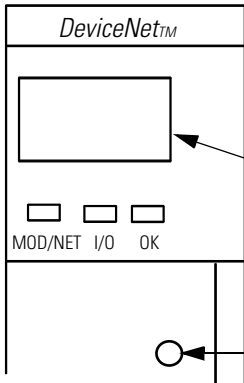

1. Firmware major revision (01 through 128)
2. Firmware minor revision (01 through 255)
3. Optional Firmware Build Number
4. Baud rate (125, 250, or 500)
5. MAC ID (00 to 63)

Alphanumeric  
Display

Manual  
Configuration  
Pushbutton

### TIP



You can use RSNetWorx for DeviceNet software to set the baud rate and MAC ID of your module. The 1756-DNB module is also equipped with a manual pushbutton for setting baud rate and MAC ID, as described in the following section.

## Using the Manual Configuration Pushbutton

The 1756-DNB scanner module has a dual function pushbutton.

- Without a network connection it displays baud rates, allowing you to select the rate for your module.
- With a network connection it displays the MAC ID or network node address, allowing you to select the node address for your module.

### If your module is not connected to the network:

1. Select the network baud rate by pushing and holding the pushbutton.

■ The module's alphanumeric display cycles through the allowable baud rates (125k, 250k, 500k).

2. Release the button when the baud rate you want to select is shown on the display.

**If your module is connected to the network:**

1. Select the network node address by pushing in and holding the pushbutton.

■ The display starts at the current MAC ID and cycles through all legitimate the network node addresses (00-63).

2. Release the button when the address number shown on the display is the number you want to select.

## Interpreting the Alphanumeric Display

Your 1756-DNB scanner module displays alphanumeric codes that provide diagnostic information about your module. The alphanumeric display flashes the codes at approximately 1 second intervals.

### *What is Displayed?*

As an example, the display for RUN toggles between the network address and the mode:

A#01  
RUN

If there is a *problem*, the display shows the network address, followed by the MAC ID of the problem node, followed by the error code. The display toggles through these elements until the error is corrected.

A#01  
N#33  
E#72

The following table summarizes the codes.

### Alphanumeric Status Codes

Code	Description	Recommended Action
70	Scanner failed Duplicate Node Address check	Change the scanner address to another available one. The node address you selected is already in use on that network.
71	Illegal data in scan list table (node number alternately flashes).	Reconfigure the scan list table and remove any illegal data.
72	Slave device stopped communicating (node number alternately flashes).	Inspect the slave devices and verify connections.
73	Device's identity information does not match electronic key in scan list table entry (node number alternately flashes).	Verify that the correct device is at this node number. Make sure the device at the scrolling node address matches the desired electronic key (vendor, product code, product type, etc.).



## Alphanumeric Status Codes

<b>Code</b>	<b>Description</b>	<b>Recommended Action</b>
74	Data overrun on port detected.	Modify your configuration and check for invalid data. Check network communication traffic.
75	No traffic detected on the network.	Check the network configuration.
76	No direct network traffic for scanner detected.	None. The scanner hears other network communication, but none directed to itself.
77	Data size expected by the device does not match scan list entry (node number alternately flashes).	Reconfigure your module for the correct transmit and receive data sizes.
78	Slave device in scan list table does not exist (node number alternately flashes).	Add the device to the network, or delete the scan list entry for that device.
79	Scanner has failed to transmit a message.	Make sure that your module is connected to a valid network. Check for disconnected cables.
80	Scanner is in IDLE mode.	Put controller in RUN mode. Enable RUN bit in Module Command Register.
81	Scanner is in FAULT mode.	Check Module Command Register for FAULT bit set.
82	Error detected in sequence of fragmented I/O messages from device (node number alternately flashes).	Check scan list table entry for slave device to make sure that input and output data lengths are correct. Check slave device configuration.
83	Slave device is returning error responses when scanner attempts to communicate with it (node number alternately flashes).	Check accuracy of scan list table entry. Check slave device configuration. Slave device may be in another master's scan list. Reboot slave device.
84	Scanner is initializing the DeviceNet network.	None. This code clears itself once scanner attempts to initialize all slave devices on the network.
85	Data size was incorrect for this device at runtime.	Slave device is transmitting incorrect length data. Try replacing slave device.
86	Device is producing zero length data (idle state) while scanner is in Run Mode.	Check device configuration and slave node status.
90	User has disabled communication port	Check Module Command Register for DISABLE bit set.

### Alphanumeric Status Codes

<b>Code</b>	<b>Description</b>	<b>Recommended Action</b>
91	Bus-off condition detected on comm port. Scanner is detecting communication errors.	Check DeviceNet connections and physical media integrity. Check system for failed slave devices or other possible sources of network interference.
92	No network power detected on communication port.	Provide network power. Make sure that module drop cable is providing network power to module comm. port.
95	Application FLASH update in progress.	None. Do not disconnect the module while application FLASH is in progress. You will lose any existing data in the scanner's memory.
97	Scanner halted by user command.	Check Module Command Register for HALT bit set.
98	General firmware error.	Replace module.
A#00 to A#63	Normal operation. The numeric display matches the scanner's node address on the DeviceNet network.	Do nothing.
IDLE	Scanner is in IDLE mode.	Put controller in RUN mode. Enable RUN bit in Module Command Register.
Network Disabled	User has disabled communication port.	Reconfigure your module. check Module Command Register.
No Network Power	No network power detected on communication port.	Provide network power. Make sure that scanner drop cable is providing network power to scanner communication port.
NoRX	No scan list is active in the module or no messages have been received by the scanner.	Enter a scan list. Check DeviceNet connection on front of module.
NoTX	No direct network traffic for scanner detected.	None. The scanner hears other network communication.

## Interpreting the LED Status Indicators

The three LED status indicators on the module provide information about your network and its connections. The following tables outline the indicator condition and the corresponding status, and explain what each condition means.

### Module/Network (MOD/NET) Status Indicator

This bi-color (green/red) LED provides device and communication status as follows:

Condition	Status	Indicates
off	not powered/ not online	Device is not online. <ul style="list-style-type: none"> <li>The device has not completed the Dup_MAC_ID test yet.</li> <li>The device may not be powered.</li> </ul>
green	device operational AND online and connected	Device is operating in a normal condition and is online with connections established. <ul style="list-style-type: none"> <li>For a group 2 Only device, this means the device is allocated to a Master.</li> <li>For a UCMM capable device, this means the device has one or more established connections.</li> </ul>
flashing green <sup>(1)</sup>	device operational AND online and not connected or device online and device needs commissioning	The device is operating in a normal condition and is online with no connections established. <ul style="list-style-type: none"> <li>The device has passed the Dup_MAC_ID test, is online, but has no established connections to other nodes.</li> <li>For a Group 2 only device, this means that the device is not allocated to a master.</li> <li>For a UCMM capable device, this means that the device has no established connections.</li> <li>Configuration missing, incomplete, or incorrect.</li> </ul>
flashing red <sup>(1)</sup>	minor fault and/or connection time-out	Recoverable fault and/or one or more I/O connections are in the timed-out state.
red	critical fault or critical link failure	Device has an unrecoverable fault and may need to be replaced. Failed communication device. The device has detected an error (duplicate MAC ID or bus-off) that has rendered it incapable of communicating on the network.

<sup>(1)</sup> The flash rate of the LED is approximately 1 flash per second. The LED should be on for approximately 0.5 seconds and off for approximately 0.5 seconds.

## I/O Status Indicator

This bi-color (green/red) LED indicates the status of the 1756-DNB's I/O scanning state. The I/O Status LED informs you whether this device has outputs under control and whether any outputs or inputs are active (outputs active, inputs producing, etc.) or faulted. The LED reflects the mod/state of the inputs and outputs, not necessarily the on/off condition of the I/O points themselves.

Condition	Indicates
off	Scanner is not online. Check network power.
green	Scanner is in RUN mode, outputs are under control, and inputs are being consumed.
flashing green <sup>(1)</sup>	Scanner is in IDLE mode, outputs are <b>not</b> under control, and inputs are being consumed.

<sup>(1)</sup> The flash rate of the LED is approximately 1 flash per second. The LED should be on for approximately 0.5 seconds and off for approximately 0.5 seconds.

## Health (OK) Status Indicator

This bi-color (green/red) LED indicates whether the device has power and is operating properly.

Condition	Status	Indicates
off	no power	No power applied to device. Apply chassis power. Verify module is completely inserted into chassis and backplane.
green	device operational	Device is operating normally. The DNB has at least one connection to it from a controller.
flashing green <sup>(1)</sup>	device in standby	The device is operating correctly; however, no controller is controlling it. Verify that the DNB module is properly configured in the controller's I/O configuration.
red	unrecoverable fault or device self testing	Device has an unrecoverable fault; repair or replace it, or Device is in self test during power-up.

<sup>(1)</sup> The flash rate of the LED is approximately 1 flash per second. The LED should be on for approximately 0.5 seconds and off for approximately 0.5 seconds.

## ControlLogix Controller Interface

The 1756-DNB module supports several different size input, output, and status structures over the ControlLogix backplane. These I/O structures were created to reduce the complexity of connecting DeviceNet I/O and status data with ladder programs. The module creates all 3 structures whether or not DeviceNet nodes are configured or online. The RSLogix 5000 software directs the controller to connect to these predefined default I/O structures. The controller automatically performs periodic updates of the structures on a cyclic basis.

The RSNetWorx for DeviceNet software configures scanlist map segments that are used to copy specific portions of I/O data between the I/O structures and DeviceNet network packets.

### IMPORTANT

The 1756-DNB scanner supports ControlLogix connections with only one controller at a time.

## Output Structure

The controller controls output I/O by writing output data to an output structure in the 1756-DNB module. The scanner module then delivers a copy of these output values to modules on DeviceNet. The output structure consists of a 32-bit command register and a variable size 32-bit array of up to 123 words for output data.

Output Structure Element	Description	Data Type
module command register	This 32-bit register consists of several bits that affect the module's behavior on the network.	1 x 32-bit register
output_data		123 x 32-bit data array

## Module Command Register Bit Definitions

The bits of the Module Command Register are defined as follows:

Bit	Name	Description
0	Run	1 = run mode 0 = idle mode
1	Fault	1 = fault network
2	DisableNetwork	1 = disable network
3	HaltScanner	1 = halt module (the DNB module ceases all operation.)
4	Reset	1 = reset module (put back to 0 to resume operation.)
5 - 31	{Reserved}	<i>unused</i>

### IMPORTANT

If the module is halted because the HaltScanner bit is set, power must be physically recycled to restart the module.

## Input Structure

The controller receives input I/O by reading input data from an input structure in the 1756-DNB module. The scanner module receives input data from DeviceNet modules and delivers a copy of these values to the controller. The input structure consists of one 32-bit status register and a variable size 32-bit array of up to 124 words for input data. The 32-bit status register reflects the current state of several key module-level operational parameters.

The input structure consists of these data elements.

Input Structure Element	Data Type
module status register	1 x 32-bit register
input_data	123 x 32-bit variable size data array

## Module Status Register Bit Definitions

The bits of the Module Status Register are defined as follows:

Bit	Name	Description
0	Run	1 = in run mode. 0 = in idle mode.
1	Fault	1 = network is faulted.
2	DisableNetwork	1 = network is disabled.
3	DeviceFailure	1 = device failure exists (examine the status structure for causes).
4	AutoverifyFailure	1 = at least one device has failed to be initialized by the scanner.
5	CommFailure	1 = communication failure exists.
6	DupNodeFail	1 = failure due to duplicate node address.
7	DnetPowerDetect	1 = DeviceNet power failure.
8 - 31	{Reserved}	<i>unused</i>

## Status Structure

The controller receives status information concerning the 1756-DNB module's ability to exchange DeviceNet messages with other nodes by reading from the status structure in the 1756-DNB module. The scanner module periodically updates the contents of the status structure and copies its contents to the controller. The status structure consists of several tables. The bit position of each of the 64 bits that make up a given status table directly corresponds to the node address of a device.

The status structure consists of these data elements:

<b>Status Structure Element</b>	<b>Description</b>	<b>Data Type</b>	<b>DINTS</b>
ScanCounter	counter incremented each I/O scan	32-bit	10
DeviceFailureRegister	device failed bit table; 1 = failed	64-bit	
AutoverifyFailureRegister	device I/O size does not match scanner's internal table; 1 = mismatch	64-bit	
DeviceIdleRegister	device is idle bit table; 1 = idle	64-bit	
ActiveNodeRegister	node online bit table; 1 = online	64-bit	
StatusDisplay	ASCII representation of DNB alphanumeric display	4-byte	
ScannerDeviceStatus	Scanner device status:	4-byte binary	11
ScannerAddress	DeviceNet address of DNB module	8-bit binary	
ScannerStatus	status of 1756-DNB module	8-bit binary	
ScrollingDeviceAddress	scrolls through DeviceNet nodes once per second by address and status (0 = no faults).	8-bit binary	
ScrollingDeviceStatus		8-bit binary	
ReservedArray	future expansion (20 bytes)	20 x 8-bit	16
DeviceStatus	DeviceNet node status array, byte per device	64 x 8-bit	24/32



## Hazardous Location Information

### The following information applies when operating this equipment in hazardous locations:

Products marked “CL I, DIV 2, GP A, B, C, D” are suitable for use in Class I Division 2 Groups A, B, C, D, Hazardous Locations and nonhazardous locations only. Each product is supplied with markings on the rating nameplate indicating the hazardous location temperature code. When combining products within a system, the most adverse temperature code (lowest “T” number) may be used to help determine the overall temperature code of the system. Combinations of equipment in your system are subject to investigation by the local Authority Having Jurisdiction at the time of installation.

---

**WARNING****EXPLOSION HAZARD**

- Do not disconnect equipment unless power has been removed or the area is known to be nonhazardous.
  - Do not disconnect connections to this equipment unless power has been removed or the area is known to be nonhazardous. Secure any external connections that mate to this equipment by using screws, sliding latches, threaded connectors, or other means provided with this product.
  - Substitution of components may impair suitability for Class I, Division 2.
  - If this product contains batteries, they must only be changed in an area known to be nonhazardous.
-

## Informations sur l'utilisation de cet équipement en environnements dangereux:

Les produits marqués "CL I, DIV 2, GP A, B, C, D" ne conviennent qu'à une utilisation en environnements de Classe I Division 2 Groupes A, B, C, D dangereux et non dangereux. Chaque produit est livré avec des marquages sur sa plaque d'identification qui indiquent le code de température pour les environnements dangereux. Lorsque plusieurs produits sont combinés dans un système, le code de température le plus défavorable (code de température le plus faible) peut être utilisé pour déterminer le code de température global du système. Les combinaisons d'équipements dans le système sont sujettes à inspection par les autorités locales qualifiées au moment de l'installation.

---





### AVERTISSEMENT



### RISQUE D'EXPLOSION

- Couper le courant ou s'assurer que l'environnement est classé non dangereux avant de débrancher l'équipement.
  - Couper le courant ou s'assurer que l'environnement est classé non dangereux avant de débrancher les connecteurs. Fixer tous les connecteurs externes reliés à cet équipement à l'aide de vis, loquets coulissants, connecteurs filetés ou autres moyens fournis avec ce produit.
  - La substitution de composants peut rendre cet équipement inadapté à une utilisation en environnement de Classe 1, Division 2.
  - S'assurer que l'environnement est classé non dangereux avant de changer les piles.
-

## Specifications

Parameter	Specification
Module Location	any slot in the ControlLogix chassis
Maximum Backplane Current Load	600mA @ 5.0V dc and 3mA @ 24V dc from ControlLogix chassis backplane
Maximum DeviceNet Current Load	90mA maximum @11-25V dc 30mA typical @ 11-25V dc
Power Dissipation	5.3W maximum
Environmental Conditions	
Operational Temperature:	0 to 60°C (32° to 140°F)
Storage Temperature:	-40° to 85°C (-40° to 185°F)
Relative Humidity:	5-95% without condensation
Shock Unpackaged	30g operational 50g non-operational
Vibration Unpackaged	5g from 10-150Hz
Conductors	Category 2 <sup>(1)</sup>
Agency Certification (when product is marked)	 Listed Industrial Control Equipment  Certified Process control Equipment Certified Class I, Division 2, Group A,B,C,D  Approved class I, Division 2, Group A,B,C,D  Marked for all applicable directives  Marked for all applicable acts N223

<sup>(1)</sup> Refer to the Industrial Automation Wiring and Grounding Guidelines, publication 1770-4.1.

ControlLogix is a trademark of Rockwell Automation.

DeviceNet is a trademark of Open DeviceNet Vendors Association (ODVA).

RSLogix 5000 and RSNetWorx for DeviceNet are trademarks of Rockwell Software Inc.

---

**Reach us now at [www.rockwellautomation.com](http://www.rockwellautomation.com)**

Wherever you need us, Rockwell Automation brings together leading brands in industrial automation including Allen-Bradley controls, Reliance Electric power transmission products, Dodge mechanical power transmission components, and Rockwell Software. Rockwell Automation's unique, flexible approach to helping customers achieve a competitive advantage is supported by thousands of authorized partners, distributors and system integrators around the world.

**Americas Headquarters**, 1201 South Second Street, Milwaukee, WI 53204, USA, Tel: (1) 414 382-2000, Fax: (1) 414 382-4444  
**European Headquarters SA/NV**, avenue Hermann Delbroux, 46, 1160 Brussels, Belgium, Tel: (32) 2 663 06 00, Fax: (32) 2 663 06 40  
**Asia Pacific Headquarters**, 27/F Citicorp Centre, 18 Whitfield Road, Causeway Bay, Hong Kong, Tel: (852) 2887 4788, Fax: (852) 2508 1946



Publication 1756-IN566B-EN-P - April 2001  
Supersedes Publication 1756-5.66 - May 1998

PN 957536-69

© 2001 Rockwell International Corporation. Printed in USA