



Installation Instructions

ControlLogix Voltage/Current Output Module

(Catalog Number 1756-OF4)

To:	See page:
Obtain a User Manual	1
Identify the Module Components	2
Prevent Electrostatic Discharge	3
See Removal and Insertion Under Power (RIUP)	3
Understand Compliance to European Union Directive	4
Note the Power Requirements	5
Install the Module	5
Key the Removable Terminal Block/Interface Module	6
Wire the Module	8
Assemble the Removable Terminal Block and the Housing	10
Install the Removable Terminal Block onto the Module	10
Check the Indicators	12
Remove the Removable Terminal Block from the Module	13
Remove the Module	14
See 1756-OF4 Specifications	14
Hazardous Location information	16

Obtain a User Manual

This product also has a user manual (pub. no. 1756-6.5.9). To view it, visit www.ab.com/manuals or www.theautomationbookstore.com. You can also purchase a printed manual by:

- contacting your local distributor or Rockwell Automation representative
- visiting www.theautomationbookstore.com and placing an order

2 ControlLogix Voltage/Current Output Module

- calling 800.963.9548 (USA/Canada) or 001.320.725.1574 (outside USA/Canada)

Identify the Module Components

You received the following components with your order:

- 1756-OF4 module
- Removable Terminal Block (RTB) door label

If you did not receive these components, contact your Rockwell Automation sales office.

This module mounts in a ControlLogix™ chassis and uses a separately-ordered RTB or a Bulletin 1492 Interface Module (IFM) to connect all field-side wiring.

This module uses one of the following RTBs:

- 1756-TBNH 20 position NEMA RTB
- 1756-TBSH 20 position Spring Clamp RTB

Use an extended-depth cover (1756-TBE) for applications with heavy gauge wiring or requiring additional routing space. When using an IFM, consult the documentation that came with it to connect all wiring.

IMPORTANT

Before you install your module, you should have already:

- installed and grounded a 1756 chassis and power supply.
 - ordered and received an RTB or IFM and its components for your application.
-

Prevent Electrostatic Discharge

ATTENTION

Electrostatic discharge can damage integrated circuits or semiconductors if you touch backplane connector pins. Follow these guidelines when you handle the module:

- Touch a grounded object to discharge static potential.
- Wear an approved wrist-strap grounding device.
- Do not touch the backplane connector or connector pins.
- Do not touch circuit components inside the module.
- If available, use a static-safe work station.
- When not in use, keep the module in its static-shield box.

Removal and Insertion Under Power (RIUP)

WARNING

This module is designed so you can remove and insert it under backplane power and field-side power. When you remove or insert a module while field-side power is applied, you may cause an electrical arc. An electrical arc can cause personal injury or property damage because it may:

- send an erroneous signal to your system's field devices, causing unintended machine motion or loss of process control.
- cause an explosion in a hazardous environment.

Repeated electrical arcing causes excessive wear to contacts on both the module and its mating connector. Worn contacts may create electrical resistance.

When you insert or remove the module while backplane power is on, or you connect or disconnect the RTB with field-side power applied, an electrical arc can occur. This could cause an explosion in hazardous location installations. Be sure that power is removed or the area is non-hazardous before proceeding.

Understand Compliance to European Union Directive

If this product bears the CE marking, it is approved for installation within the European Union and EEA regions. It has been designed and tested to meet the following directives.

EMC Directive

This product is tested to meet Council Directive 89/336/EEC Electromagnetic Compatibility (EMC) and the following standards, in whole or in part, documented in a technical construction file:

- EN 50081-2 EMC - Generic Emission Standard, Part 2 - Industrial Environment
- EN 50082-2 EMC - Generic Immunity Standard, Part 2 - Industrial Environment

This product is intended for use in an industrial environment.

Low Voltage Directive

This product is tested to meet Council Directive 73/23/EEC Low Voltage, by applying the safety requirements of EN 61131-2 Programmable Controllers, Part 2 - Equipment Requirements and Tests.

For specific information required by EN 61131-2, see the appropriate sections in this publication, as well as the following Allen-Bradley publications:

- Industrial Automation Wiring and Grounding Guidelines, publication 1770-4.1
- Automation Systems Catalog, publication B111

This equipment is classified as open equipment and must be installed (mounted) in an enclosure during operation as a means of providing safety protection.

Note the Power Requirements

This module receives power from the 1756 chassis power supply and requires 2 sources of power from the backplane:

- 150mA at 5.1V dc
- 120mA at 24V dc

Add this current/power value (3.65W) to the requirements of all other modules in the chassis to prevent overloading the power supply.

Install the Module

You can install or remove the module while chassis power is applied.

ATTENTION



The module is designed to support Removal and Insertion Under Power (RIUP). However, when you remove or insert an RTB with field-side power applied, **unintended machine motion or loss of process control can occur**. Exercise extreme caution when using this feature.

1. Align circuit board with top and bottom chassis guides.

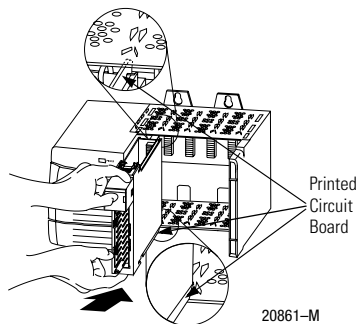

2. Slide module into chassis until module locking tabs 'click'.

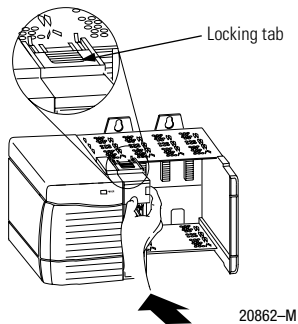

Key the Removable Terminal Block/Interface Module

Wedge-shaped keying tabs and U-shaped keying bands came with your RTB to prevent connecting the wrong wires to your module.

Key positions on the module that correspond to unkeyed positions on the RTB. For example, if you key the first position on the module, leave the first position on the RTB unkeyed.

Key the Module

1. Insert the U-shaped band as shown.
2. Push the band until it snaps in place.

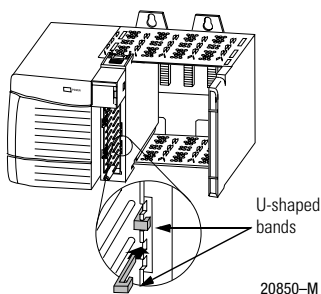

Key the RTB/IFM

1. Insert the wedge-shaped tab with rounded edge first.
2. Push the tab until it stops.

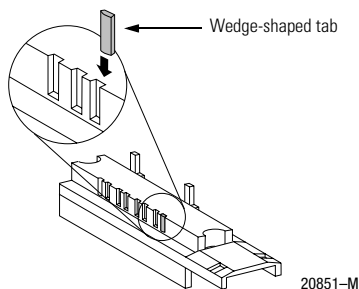

Reposition the tabs to rekey future module applications.

Wire the Removable Terminal Block

Wire the RTB with a 5/16 inch (8mm) maximum flat-bladed screwdriver before installing it onto the module.

Shielded cable is required when using this module. We recommend using Belden 8761 cable to wire the RTB. The RTB terminations can accommodate 14-22 gauge shielded wire.

Connect grounded end of the cable

1. Ground the drain wire.

IMPORTANT

We recommend grounding the drain wire at the field-side. If you cannot ground at the field-side, ground at an earth ground on the chassis as shown.

A. Remove a length of cable jacket from the connecting cable.



B. Pull the foil shield and bare drain wire from the insulated wire.

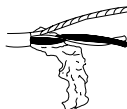

C. Twist the foil shield and drain wire together to form a single strand.



D. Attach a ground lug and apply heat shrink tubing to the exit area.



20104-M

E. Connect the drain wire to a chassis mounting tab.

Use any chassis mounting tab that is designated as a functional signal ground.

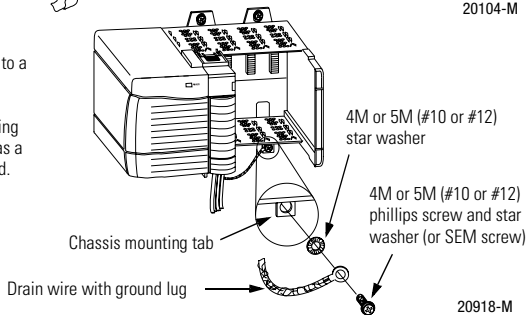

20918-M

2. Connect the insulated wires to the field-side.

Connect ungrounded end of the cable

1. Cut the foil shield and drain wire back to the cable casing and apply shrink wrap.
2. Connect the insulated wires to the RTB (see page 8).

Spring Clamp RTB

- A.** Strip 7/16 inch (11mm) maximum length of wire.
- B.** Insert the screwdriver into the inner hole of the RTB.

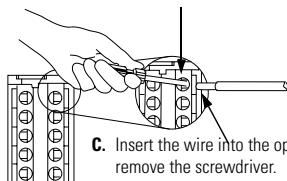

- C.** Insert the wire into the open terminal and remove the screwdriver.

NEMA Screw RTB

- A.** Strip 5/16 inch (8mm) maximum length of wire.
- B.** Turn the terminal screw counterclockwise.
- C.** Wrap wire around the terminal.
- D.** Turn the terminal screw clockwise.

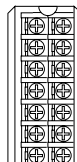

Wire the Module

You can only connect wiring to your module through an RTB or IFM. The example below shows how to wire the module.

1756-OF4 current wiring example

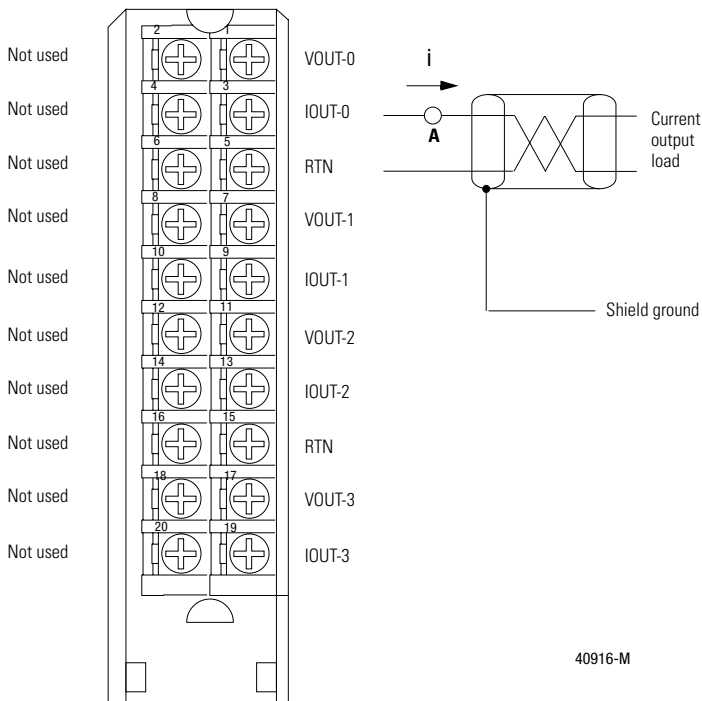

- NOTES: **1.** Place additional loop devices (e.g strip chart recorders) at the A location shown above.
2. If separate power sources are used, do not exceed the specified isolation voltage.

1756-OF4 voltage wiring example

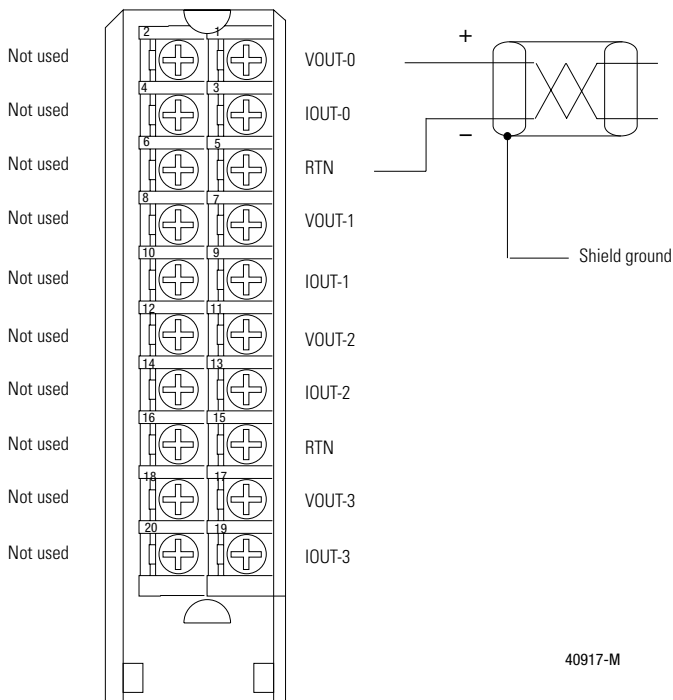

NOTE: If separate power sources are used, do not exceed the specified isolation voltage.

After completing field-side wiring, secure the wires in the strain relief area with a cable-tie.

Assemble the Removable Terminal Block and the Housing

1. Align the grooves at the bottom of the housing with the side edges of the RTB.

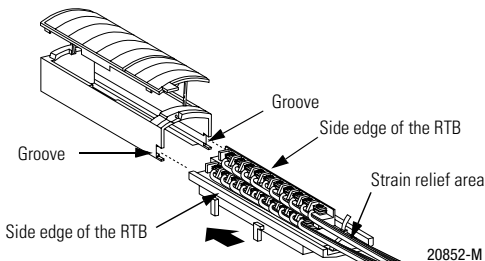

2. Slide the RTB into the housing until it snaps into place.

Install the Removable Terminal Block onto the Module

WARNING



The RTB is designed to support Removal and Insertion Under Power (RIUP). However, when you remove or insert an RTB with field-side power applied, **unintended machine motion or loss of process control can occur**. Exercise extreme caution when using this feature. It is recommended that field-side power be removed before installing the RTB onto the module.

When you remove or insert a module while field-side power is applied, you may cause an electrical arc. An electrical arc can cause personal injury or property damage because it may:

- send an erroneous signal to your system's field devices, causing unintended machine motion or loss of process control.
- cause an explosion in a hazardous environment.

Repeated electrical arcing causes excessive wear to contacts on both the module and its mating connector. Worn contacts may create electrical resistance.

When you insert or remove the module while backplane power is on, or you connect or disconnect the RTB with field-side power applied, an electrical arc can occur. This could cause an explosion in hazardous location installations. Be sure that power is removed or the area is non-hazardous before proceeding.

Before installing the RTB, make certain:

- field-side wiring of the RTB has been completed.
- the RTB housing is snapped into place on the RTB.
- the RTB housing door is closed.
- the locking tab at the top of the module is unlocked.

1. Align the side and top, bottom RTB guides with the side, top and bottom module guides.

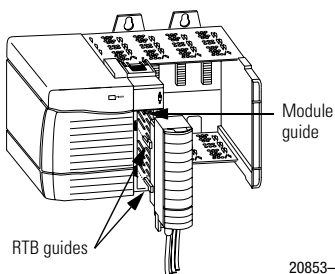

2. Press quickly and evenly to seat the RTB on the module until the latches snap into place.

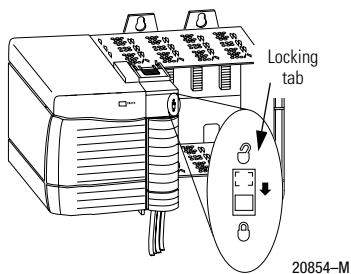

3. Slide the locking tab down to lock the RTB onto the module.

Check the Indicators

The indicators show CAL status (green) and a bi-colored LED for module "OK" (red/green).

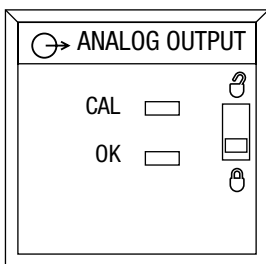

20965-M

During power up, an indicator test is done and the following occurs:

- The "OK" indicator turns red for 1 second and then turns to flashing green if it has passed the self-test.

LED indicators:	This display:	Means:	Take this action:
OK	Steady green light	The outputs are in a normal operating state.	None
OK	Flashing green light	The module has passed internal diagnostics but is not actively controlled.	Configure the module.
OK	Flashing red light	Previously established communication has timed out.	Check controller and chassis communication
OK	Steady red light	The module must be replaced.	Replace the module.
CAL	Flashing green light	The module is in calibration mode.	None

This completes installation of the module. Use the information below to remove the module.

Remove the Removable Terminal Block from the Module

WARNING

Shock hazard exists. If the RTB is removed from the module while the field-side power is applied, the module will be electrically live. Do not touch the RTB's terminals. Failure to observe this caution may cause personal injury.

The RTB is designed to support Removal and Insertion Under Power (RIUP). However, when you remove or insert an RTB with field-side power applied, **unintended machine motion or loss of process control can occur.** Exercise extreme caution when using this feature. It is recommended that field-side power be removed before removing the module.

When you insert or remove the module while backplane power is on, or you connect or disconnect the RTB with field-side power applied, an electrical arc can occur. This could cause an explosion in hazardous location installations. Be sure that power is removed or the area is non-hazardous before proceeding.

Before removing the module, you must remove the RTB.

1. Unlock the locking tab at the top of the module.

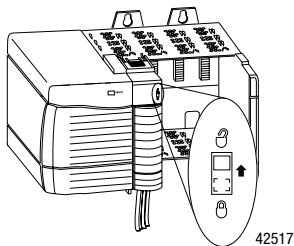

2. Open the RTB door and pull the RTB off the module.

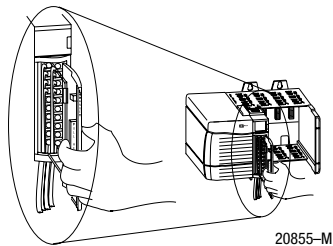

14 ControlLogix Voltage/Current Output Module



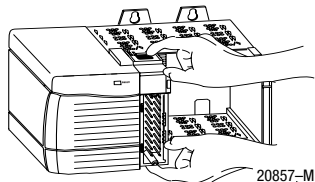
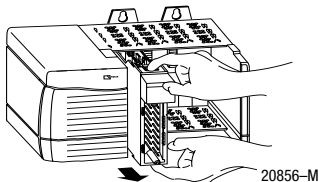

Remove the Module

1. Push in top and bottom locking tabs.
2. Pull module out of the chassis.



1756-OF4 Specifications

Number of Outputs	4 current or 4 voltage output channels
Module Location	1756 ControlLogix Chassis
Backplane Current	150mA @ 5.1V dc & 120mA @ 24V dc (Total backplane power 3.65W)
Power Dissipation within Module Thermal Dissipation	3.25W - 4 channel current 11.08 BTU/hr
Output Current Range	0 to 21mA +/- 10.4V
Current Resolution	15 bits across 21mA - 650nA/bit 15 bits across 10.5V - 320 μ V/bit
Data Format	Integer mode (Left justified, 2s complement) Floating point IEEE 32 bit
Open Circuit Detection	Current output only (Output must be set to >0.1mA)
Output Overvoltage Protection	24V ac/dc
Output Short Circuit Protection	Electronically current limited to 21mA or less
Drive Capability	>2000 Ω - voltage 0-750 Ω - current
Output Settling Time	<2ms to 95% of final value with resistive loads
Calibrated Accuracy at 25°C Calibration Interval	Better than 0.05% of range from 4mA to 21mA, -10.4V to 10.4V Twelve months typical
Output Offset Drift with Temperature	50 μ V/ degree C typical 100nA/degree C typical
Gain Drift with Temperature	25 ppm/degree C maximum - voltage 50 ppm/degree C maximum - current

Module Error over Full Temperature Range	0.15% of range - voltage 0.3% of range - current
Module Scan Time for all Channels	12ms minimum floating point 8ms minimum integer
Isolation Voltage User to system	100% tested at 2550V dc for 1 second
Module Conversion Method	R-Ladder DAC, monotonicity with no missing codes
Module Keying (Backplane)	Electronic
RTB Screw Torque (NEMA)	7-9 inch-pounds (0.8-1Nm)
RTB Keying	User defined
RTB and Housing	20 Position RTB (1756-TBNH or TBSH) ¹
Environmental Conditions Operating Temperature Storage Temperature Relative Humidity	0 to 60°C (32 to 140°F) -40 to 85°C (-40 to 185°F) 5 to 95% noncondensing
Conductors Wire Size Category	22-14 gauge (2mm ²) stranded maximum ¹ 3/64 inch (1.2mm) insulation maximum 2 ^{2, 3}
Screwdriver Width for RTB	5/16 inch (8mm) maximum
Agency Certification (when product or packaging is marked)	 Listed Industrial Control Equipment  Certified Process Control Equipment Certified Class I, Division 2, Group A, B, C, D  Approved Class I, Division 2, Group A, B, C, D  Marked for all applicable directives  Marked for all applicable acts N223

¹ Maximum wire size will require extended housing - 1756-TBE.

² Use this conductor category information for planning conductor routing as described in the system level installation manual.

³ Refer to publication 1770-4.1 "Industrial Automation Wiring and Grounding Guidelines".

Additional Notes

The ControlLogix system must be mounted within a suitable enclosure to prevent personal injury resulting from accessibility to live parts. The interior of this enclosure must be accessible only by the use of a tool.

This industrial control equipment is intended to operate in a Pollution Degree 2 environment, in overvoltage category II applications, as defined in IEC publication 664A, at altitudes up to 2000 meters without derating.

Hazardous Location information

The following information applies when operating this equipment in hazardous locations:

Products marked “CL I, DIV 2, GP A, B, C, D” are suitable for use in Class I Division 2 Groups A, B, C, D, Hazardous Locations and nonhazardous locations only. Each product is supplied with markings on the rating nameplate indicating the hazardous location temperature code. When combining products within a system, the most adverse temperature code (lowest “T” number) may be used to help determine the overall temperature code of the system. Combinations of equipment in your system are subject to investigation by the local Authority Having Jurisdiction at the time of installation.

WARNING



EXPLOSION HAZARD

- Do not disconnect equipment unless power has been removed or the area is known to be nonhazardous.
 - Do not disconnect connections to this equipment unless power has been removed or the area is known to be nonhazardous. Secure any external connections that mate to this equipment by using screws, sliding latches, threaded connectors, or other means provided with this product.
 - Substitution of components may impair suitability for Class I, Division 2.
 - If this product contains batteries, they must only be changed in an area known to be nonhazardous.
-

Informations sur l'utilisation de cet équipement en environnements dangereux :

Les produits marqués « CL I, DIV 2, GP A, B, C, D » ne conviennent qu'à une utilisation en environnements de Classe I Division 2 Groupes A, B, C, D dangereux et non dangereux. Chaque produit est livré avec des marquages sur sa plaque d'identification qui indiquent le code de température pour les environnements dangereux. Lorsque plusieurs produits sont combinés dans un système, le code de température le plus défavorable (code de température le plus faible) peut être utilisé pour déterminer le code de température global du système. Les combinaisons d'équipements dans le système sont sujettes à inspection par les autorités locales qualifiées au moment de l'installation.

AVERTISSEMENT



RISQUE D'EXPLOSION

- Couper le courant ou s'assurer que l'environnement est classé non dangereux avant de débrancher l'équipement.
 - Couper le courant ou s'assurer que l'environnement est classé non dangereux avant de débrancher les connecteurs. Fixer tous les connecteurs externes reliés à cet équipement à l'aide de vis, loquets coulissants, connecteurs filetés ou autres moyens fournis avec ce produit.
 - La substitution de composants peut rendre cet équipement inadapté à une utilisation en environnement de Classe 1, Division 2.
 - S'assurer que l'environnement est classé non dangereux avant de changer les piles.
-

Reach us now at www.rockwellautomation.com

Wherever you need us, Rockwell Automation brings together leading brands in industrial automation including Allen-Bradley controls, Reliance Electric power transmission products, Dodge mechanical power transmission components, and Rockwell Software. Rockwell Automation's unique, flexible approach to helping customers achieve a competitive advantage is supported by thousands of authorized partners, distributors and system integrators around the world.

Americas Headquarters, 1201 South Second Street, Milwaukee, WI 53204, USA, Tel: (1) 414 382-2000, Fax: (1) 414 382-4444
European Headquarters SA/NV, avenue Hermann Delbroux, 46, 1160 Brussels, Belgium, Tel: (32) 2 663 06 00, Fax: (32) 2 663 06 40
Asia Pacific Headquarters, 27/F Citicorp Centre, 18 Whitfield Road, Causeway Bay, Hong Kong, Tel: (852) 2887 4788, Fax: (852) 2508 1946



Publication 1756-IN016A-EN-P - October 2000
Supersedes Publication 1756-5.42 - September 1999

PN 957308-17

© 2000 Rockwell International Corporation. Printed in USA