



## Allen-Bradley Redundant Power Supplies

Cat. No. 1771-P4R and 1771-P6R

### To the Installer

This document provides you with the following information:

For this information	See page
Important user information	1
What this package contains	4
Tasks on installing your power supply module	4
How to interpret indicators	13
Flow charts for troubleshooting your power supply module	15
Power supply specifications	20

### Important User Information

Because of the variety of uses for the products described in this publication, those responsible for the application and use of these products must satisfy themselves that all necessary steps have been taken to assure that each application and use meets all performance and safety requirements, including any applicable laws, regulations, codes and standards. In no event will Rockwell Automation be responsible or liable for indirect or consequential damage resulting from the use or application of these products.

Any illustrations, charts, sample programs, and layout examples shown in this publication are intended solely for purposes of example. Since there are many variables and requirements associated with any particular installation, Rockwell Automation does not assume responsibility or liability (to include intellectual property liability) for actual use based upon the examples shown in this publication.

Allen-Bradley publication SGI-1.1, Safety Guidelines for Application, Installation, and Maintenance of Solid-State Control (available from your local Rockwell Automation office), describes some important differences between solid-state equipment and electromechanical devices that should be taken into consideration when applying products such as those described in this publication.

Reproduction of the contents of this copyrighted publication, in whole or part, without written permission of Rockwell Automation, is prohibited.

# Allen-Bradley Drives

Throughout this publication, notes may be used to make you aware of safety considerations. The following annotations and their accompanying statements help you to identify a potential hazard, avoid a potential hazard, and recognize the consequences of a potential hazard.

---

**WARNING**

Identifies information about practices or circumstances that can cause an explosion in a hazardous environment, which may lead to personal injury or death, property damage, or economic loss.

---

---

**ATTENTION**

Identifies information about practices or circumstances that may lead to personal injury or death, property damage, or economic loss.

---

---

**IMPORTANT**

Identifies information that is critical for successful application and understanding of the product.

---

**ATTENTION****Environment and Enclosure**

This equipment is intended for use in a Pollution Degree 2 industrial environment, in overvoltage Category II applications (as defined in IEC publication 60664–1), at altitudes up to 2000 meters without derating.

This equipment is considered Group 1, Class A industrial equipment according to IEC/CISPR Publication 11. Without appropriate precautions, there may be potential difficulties ensuring electromagnetic compatibility in other environments due to conducted as well as radiated disturbance.

This equipment is supplied as “open type” equipment. It must be mounted within an enclosure that is suitably designed for those specific environmental conditions that will be present, and appropriately designed to prevent personal injury resulting from accessibility to live parts. The interior of the enclosure must be accessible only by the use of a tool. Subsequent sections of this publication may contain additional information regarding specific enclosure type ratings that are required to comply with certain product safety certifications.

See NEMA Standards publication 250 and IEC publication 60529, as applicable, for explanations of the degrees of protection provided by different types of enclosures. Also, see the appropriate sections in this publication, as well as the Allen–Bradley publication 1770–4.1, (“Industrial Automation Wiring and Grounding Guidelines”), for additional installation requirements pertaining to this equipment.

**ATTENTION****Preventing Electrostatic Discharge**

This equipment is sensitive to electrostatic discharge, which can cause internal damage and affect normal operation. Follow these guidelines when you handle this equipment:

- Touch a grounded object to discharge potential static.
- Wear an approved grounding wriststrap.
- Do not touch connectors or pins on component boards.
- Do not touch circuit components inside the equipment.
- If available, use a static-safe workstation.
- When not in use, keep modules in appropriate static-safe packaging.

## What This Package Contains

When you receive your 1771-P4R or -P6R power supply, you should see the following in the box:

- one 1771-P4R or 1771-P6R power-supply module
- one 3-position terminal block (attached to module)
- one 5-position terminal block (attached to module)
- one redundant cable

## Installing the Power-supply Module

To install your power supply module you perform these tasks:

To perform this task	See page
set the jumpers	5
set the I.D. selection and configuration switches	6
place the power supplies	7
connect the redundancy cables	8
wire the alarm relay	8
connect input power	10

## Set the Jumpers

Each power supply module has two jumpers located at the back of the power supply near the edge connectors. The jumper selection provides the proper voltage regulation for the different power supply configurations. The power supply can be configured to support local or remote sensing by setting the jumpers.

1. Locate the power supply jumpers on the back edge of the module near the gold-plated edge connectors:

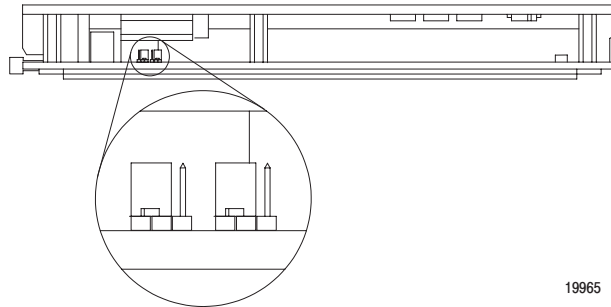

19965

2. Position the power supply module so that the jumpers and pins are facing **upward**.
3. Use needle nose pliers to position the jumpers as shown in this table.

For this configuration	Set jumpers to
All power supplies in a power-supply chassis (1771-PSC) connected to an I/O chassis.	right position 
All other configurations. (These power supplies are shipped with jumpers set to the left.)	left position 

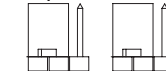
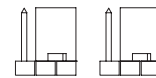

### IMPORTANT

To avoid system malfunctions, set the jumpers of power supplies in 1771 I/O chassis to the left position.

## Set the I.D. Selection and Configuration Switches

Each power supply in a redundant system must be assigned a different identification number. To do this, you must set the I.D. selection switches located on the left side of the module (shown below). A cutout in the metal cover of the module provides access to these switches.

### I.D. Selection Switch

Switches	Are set
1, 2, 3, 4	for the power supply identification number
5, 6	based on the configuration zone

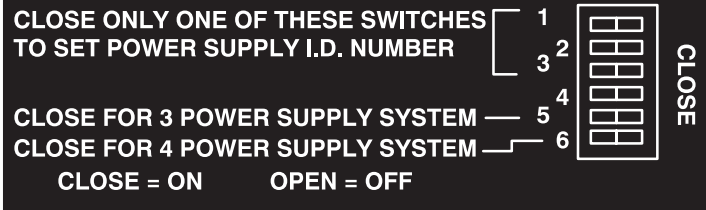

To set the switches:

1. Close the I.D. selection switch (1, 2, 3, or 4) that represents the number you selected for that power supply.
2. Determine the configuration zone being used so you can set switches 5 and 6.

### TIP

To determine the configuration zone, you must know the maximum chassis current draw and the ambient air temperature of the chassis.

Maximum Current Draw (A)	Ambient Temperature	Configuration Zone
0-8	55°C	A
	60°C	
8-14	55°C	B
	60°C	
14-16	55°C	B
	60°C	C
16-20	55°C	C
	60°C	
20-24	55°C	C
	60°C	not permitted

3. Use the following table to position switches 5 and 6 based on the configuration zone you determined.

If Configuration Zone Is	Set Switches
A	5 and 6 OPEN
B	5 CLOSED and 6 OPEN
C	5 OPEN and 6 CLOSED

---

## Place the Power Supplies

---

**ATTENTION**

Turn off the power supply module before removing it from or inserting it into a chassis. Failure to observe this warning could alter processor memory, damage module circuitry, and cause unintended operation which could possibly cause injury to personnel.

---

You can place these power supply modules into any I/O module slot in any current chassis (1771-A1B, -A2B, -A3B, -A3B1, -A4B, -PSC).

The primary requirement for placing redundant power supplies is the need to allocate 2 to 4 adjacent slots in your 1771 I/O chassis for the modules.

---

**IMPORTANT**

You cannot use the 1771-P4R, -P6R power supplies with series A 1771 I/O chassis.

---

**WARNING**

When you insert or remove the module while backplane power is on, or you connect or disconnect the wiring with field power applied, an electrical arc can occur. This could cause an explosion in hazardous location installations. Be sure power is removed or the area is nonhazardous before proceeding.

---

The power supply is a modular component of the 1771 I/O system requiring a properly installed system chassis. Refer to publication 1771-IN075 for detailed information on acceptable chassis, and proper installation and grounding requirements. Limit the adjacent slot power dissipation to 10W maximum.

## Connect the Redundancy Cables

The power supply redundancy cables (A–B pt. no. 941201–02) allow the power supplies to communicate load-sharing data. The two connectors on each supply are in parallel to permit three or four supplies to be daisy-chained together in a redundant system.

To connect the cables:

1. Connect the redundancy cable between the connectors labeled P/S REDUNDANT on the power supply as shown below.

### Connecting the Redundancy Cables for a 2, 3, or 4 Supply System

Cable pt. no. A–B 941201–02  
(supplied with power supply)

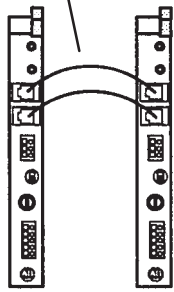

2 power-supply system

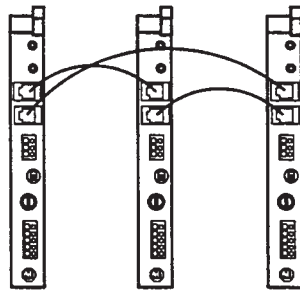

3 power-supply system

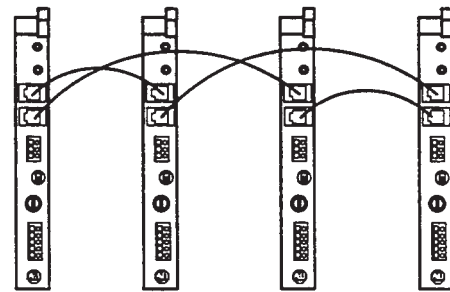

4 power-supply system

2. Loop the cable over the top of the I/O chassis to avoid picking up signals induced from I/O wiring.

### WARNING



When you insert or remove the module while backplane power is on, or you connect or disconnect the alarm relay, ac power, or redundancy cable with field power applied, an electrical arc can occur. This could cause an explosion in hazardous location installations. Be sure power is removed or the area is nonhazardous before proceeding.

## Wire the Alarm Relay

A 3-position terminal block labeled RELAY on the front panel of the module provides you with a means of communicating the status of the power supply to some alarm device. The contacts on the relay are rated at 1/6 HP, 250V ac, 1 Amp, 30V dc maximum.

The relay energizes within 0.5 seconds after sufficient input power is applied and no error conditions have been encountered. The error conditions include 5V output overvoltage, undervoltage, or overcurrent and internal reference error. The relay de-energizes within 10 seconds following detection of an error condition or loss of power. Contact bounce may occur for 100 ms.



The terminal block has three lines:

- NC (Normally Closed)
- COM (Common)
- NO (Normally Open)

Using the normally closed side of the block will keep the relay contacts open until unit failure (when it will close). Using the normally open side of the relay will keep the relay contacts closed until unit failure (when it will open).

To wire the relay, place the incoming line in the NC or NO position and out the COM position to the load. Any spare point on an input module can be connected and used for signaling by the relay.

To connect the wiring to the 3-terminal relay connector, proceed as follows:

- Strip 0.35 inches (9cm) of insulation off the wire.
- Spring the clip open to insert the wire, using a wedge-tipped tool, such as a small screwdriver.
  - If you leave the terminal block plugged into the supply, insert the tool parallel to the wire (push straight in).

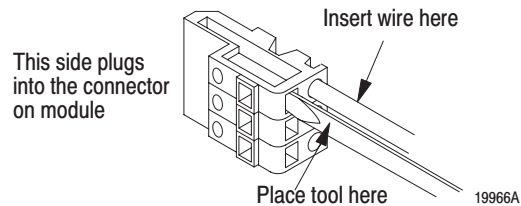

- If you remove the terminal block and lay it on a flat surface, insert the tool perpendicular to the wire (push straight down).

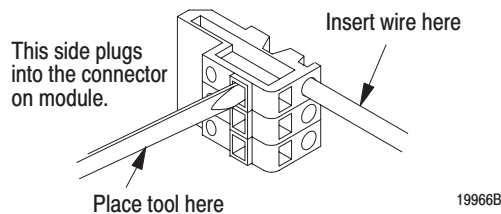

- After making the wiring connections, re-insert the terminal block into the front plate on the processor.

### Alarm Relay and AC Power Connections

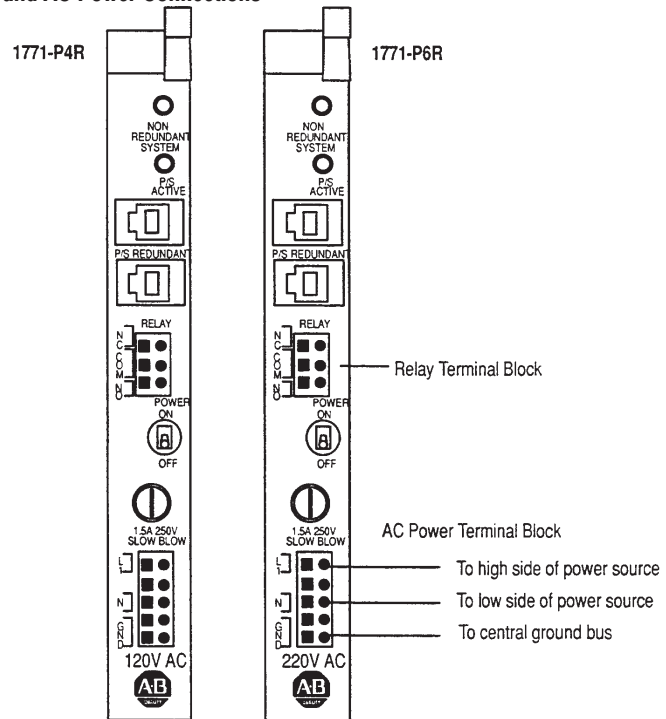

### Connect Input Power

The following figure shows the overall configuration of the ac power connections.

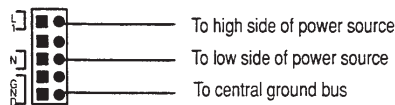

#### TIP

*The two undesignated terminals do not connect to any electrical circuit on the module. Each of the three functional terminals accepts a single 14-AWG wire max.*

To correctly connect the wire to the terminal you connect the wires to the terminal in this order:

- connect the high side of the power source to the L1 terminal of the power supply
- connect the low side of the power source to the L2 or N (neutral) terminal of the power supply
- connect the GND (ground) terminal of the power supply to the central ground bus in the enclosure

**ATTENTION**

Pay close attention to the ac GND and L1 connections when wiring the terminal block. An error here could cause the ac power to be applied to the chassis.

Check that the input voltage rating on the power supply front panel agrees with the available power source. Application of the incorrect line voltage can cause severe power supply damage.

**TIP**

*You can connect these wires while the terminal block is plugged into the supply, or you can remove the terminal block to lay it on a flat surface to connect these wires. To remove the terminal block, pull it straight out from the receptacle on the module.*

**WARNING**

When you insert or remove the module while backplane power is on, or you connect or disconnect the alarm relay, ac power, or redundancy cable with field power applied, an electrical arc can occur. This could cause an explosion in hazardous location installations. Be sure power is removed or the area is nonhazardous before proceeding.

To connect wiring to the 5-terminal ac power block, proceed as follows:

1. Connect the power cord to the ac connector (120V or 220V) of the power supply module.
  - A. Strip 0.35 inches (9cm) of insulation off the wire.
  - B. Spring the clip open to insert the wire, using a wedge-tipped tool, such as a small screwdriver.
    - If you leave the terminal block plugged into the supply, insert the tool parallel to the wire (push straight in).

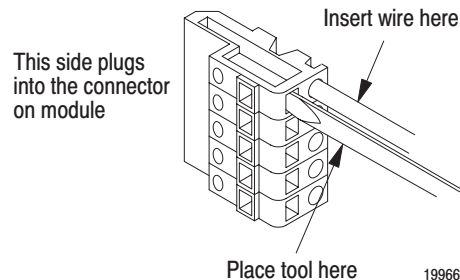

- If you remove the terminal block and lay it on a flat surface, insert the tool perpendicular to the wire (push straight down ).

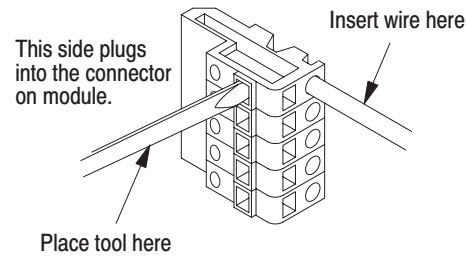

19966

- C. After making the wiring connections, re-insert the terminal block into the front plate on each processor.

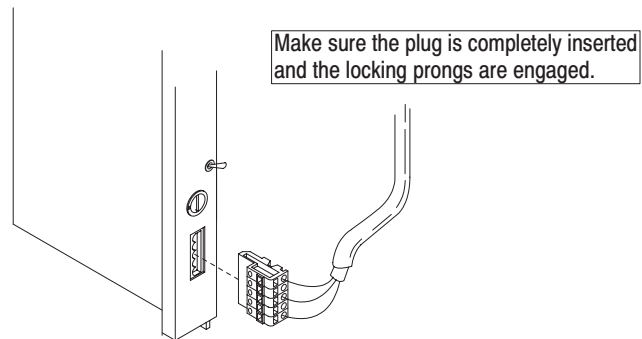

Once you have completed the tasks up to this point, you can turn the power switches ON. Turn all the power switches on at the same time. If everything is set up correctly, all P/S ACTIVE (green) indicators will be on and all NON REDUNDANT SYSTEM (yellow) indicators will be off.

## Interpreting the Power Supply Indicators

Your power supply has two indicators located in the upper half of the module front panel.

The top indicator is yellow and is labeled NON REDUNDANT SYSTEM. This indicator tells you that the number of supplies in operation is below the number required for redundant operation. The yellow indicators in a redundant system operate together; they are either all on or all off.

The lower indicator is green and is labeled P/S ACTIVE. The following table shows how to interpret this indicator.

If P/S ACTIVE indicator is	Then
ON	This power supply is operating normally and a sufficient number of power supplies is operational for the system configuration.
OFF	<p>The supply has detected one of the following conditions:</p> <ul style="list-style-type: none"> <li>• dc overvoltage (the supply shuts down)</li> <li>• dc undervoltage (the supply shuts down)</li> <li>• dc overcurrent (the supply shuts down)</li> <li>• power switch turned off (the supply is turned off)</li> <li>• ac undervoltage</li> <li>• insufficient number of operational power supplies for the system configuration</li> </ul> <p>When the P/S ACTIVE indicator is off because of an ac undervoltage or because an insufficient number of supplies is operational, the power supply may continue to deliver output power.</p>

## Troubleshoot Your Power Supplies

When you troubleshoot your power supplies, you may be required to remove and replace the power supply while power is still applied to the chassis.

For information on	See page
Removing the power supply	14
Inserting the power supply	14
Troubleshooting a single power supply	15
Troubleshooting multiple power supplies	16

# Allen-Bradley Drives

## Removing the Power Supply

**WARNING**

When you insert or remove the module while backplane power is on, or you connect or disconnect the alarm relay, ac power, or redundancy cable with field power applied, an electrical arc can occur. This could cause an explosion in hazardous location installations. Be sure power is removed or the area is nonhazardous before proceeding.

---

1. Flip the POWER switch on the front panel to the Off position, **only on the unit to be removed.**
2. Remove the ac input terminal block, the alarm relay terminal block, and the redundant cables **only from the unit to be removed.**
3. Slide the unit out of the chassis and note the following settings:
  - I.D selection switch setting (1 through 4)
  - configuration switch setting (5 and 6)
  - jumper setting (local or remote sensing)
  - input voltage rating on the front panel near the ac input connector

You will set the replacement unit to the same settings.

## Inserting the Power Supply

1. Configure the supply to the same settings as the unit removed.
2. Flip the POWER switch on the front panel to the Off position.
3. Insert the module completely into the slot in the chassis.
4. Connect redundant cables, alarm relay terminal block, and ac input terminal block.
5. Flip the POWER switch to the On position.

## Troubleshooting a Single Power Supply

If you have a single power supply installed in an I/O chassis and its P/S ACTIVE indicator is off, follow the troubleshooting flowchart below.

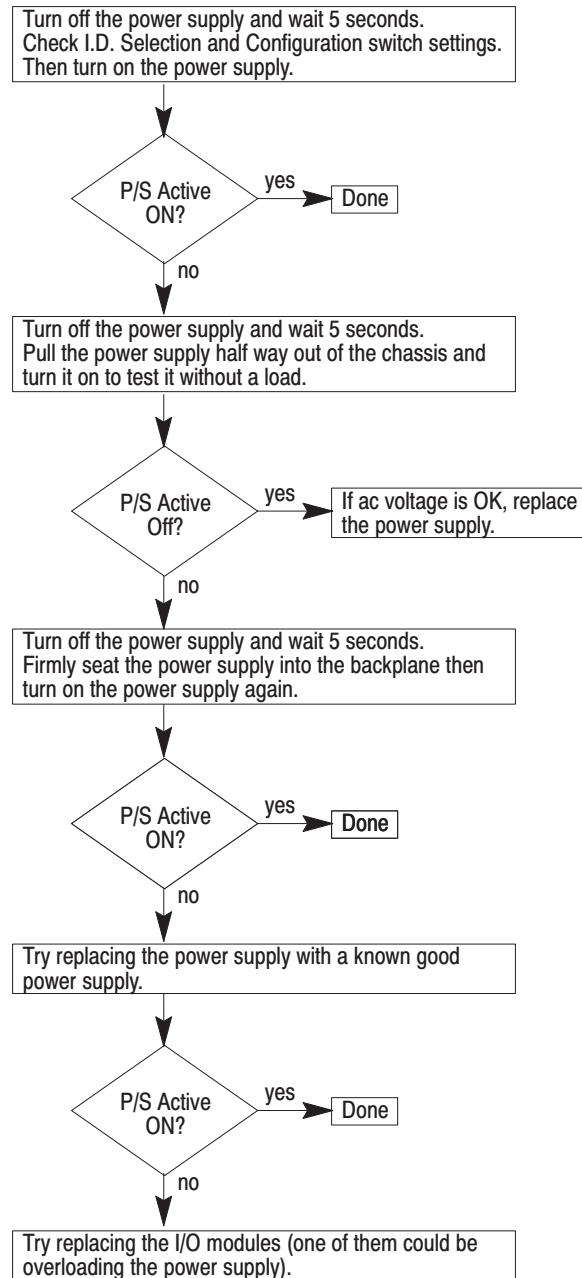

## Troubleshooting Multiple Power Supplies

If you have multiple power supplies, refer to the flowcharts on the next three pages to help you troubleshoot when the following problems occur.

### Problem 1

One or more (but not all) of the supplies in the redundant system has its P/S ACTIVE indicator off. (Depending on the system configuration, NON REDUNDANT SYSTEM indicators may or may not be on.)

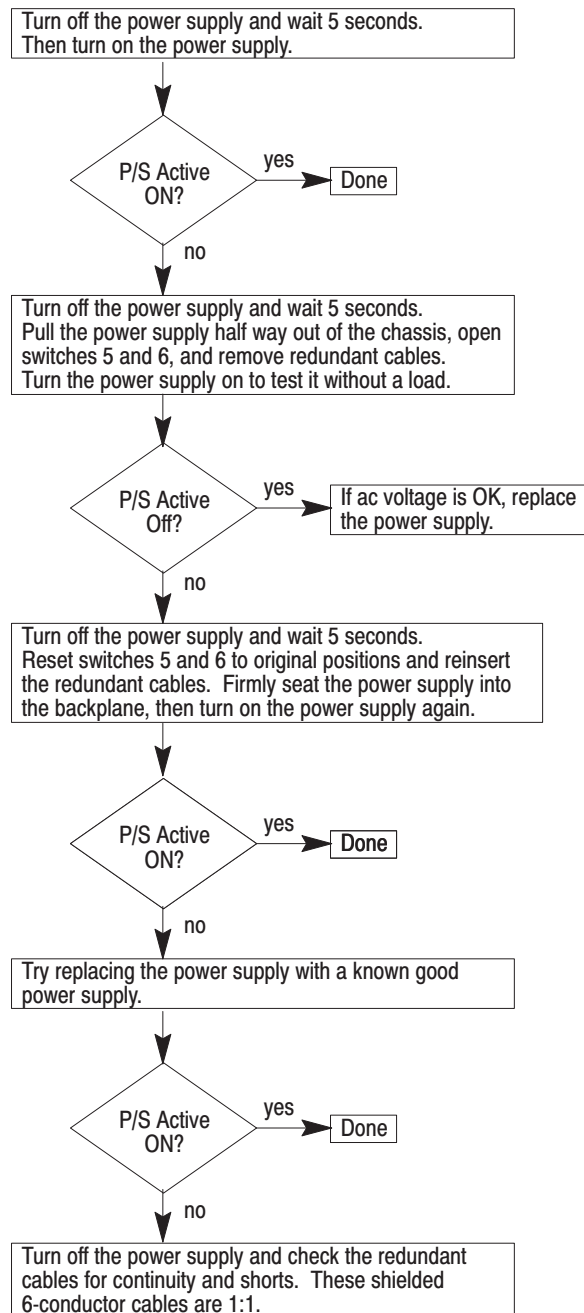



## Problem 2

All the supplies in the redundant system have their P/S ACTIVE indicators off. The NON REDUNDANT SYSTEM LED may or may not be on.

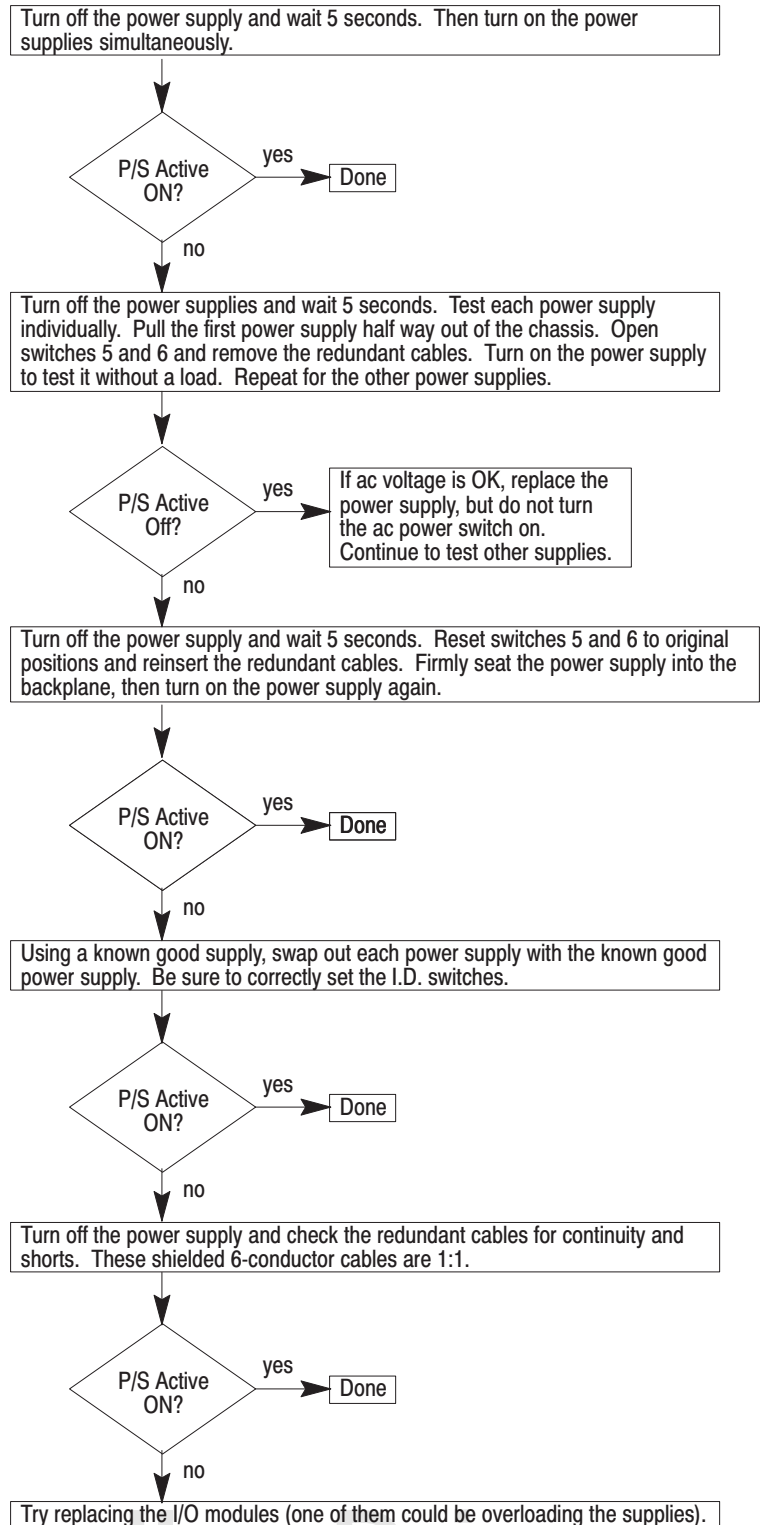

### Problem 3

All P/S ACTIVE indicators show that the power supplies are OK, but one or more NON REDUNDANT SYSTEM indicators are on, indicating the desired redundancy is not available.

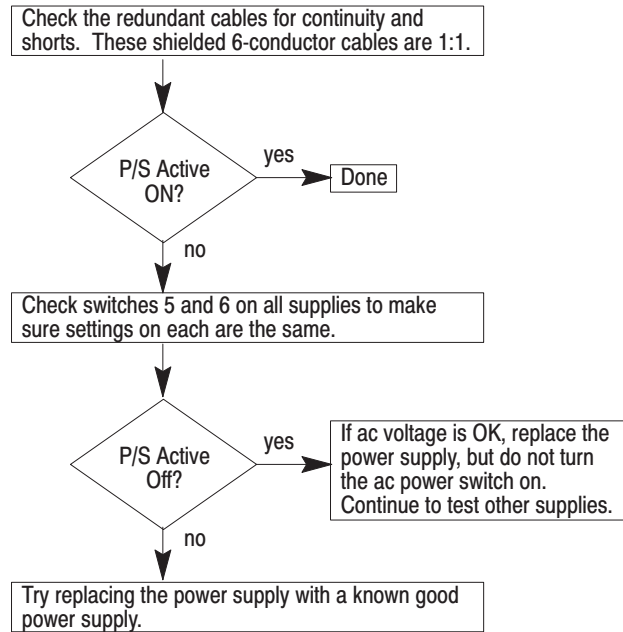

---

**The following information applies when operating this equipment in hazardous locations:**

---

Products marked “CL I, DIV 2, GP A, B, C, D” are suitable for use in Class I Division 2 Groups A, B, C, and D Hazardous Locations and nonhazardous locations only. Each product is supplied with markings on the rating nameplate indicating the hazardous location temperature code. When combining products within a system, the most adverse temperature code (lowest “T” number) may be used to help determine the overall temperature code of the system. Combinations of equipment in your system are subject to investigation by the local Authority Having Jurisdiction at the time of installation.

---

**WARNING****EXPLOSION HAZARD –**

- Do not disconnect equipment unless power has been removed or the area is known to be nonhazardous.
  - Do not disconnect connections to this equipment unless power has been removed or the area is known to be nonhazardous. Secure any external connections that mate to this equipment by using screws, sliding latches, threaded connectors, or other means provided with this product.
  - Substitution of components may impair suitability for Class I, Division 2.
  - If this product contains batteries, they must only be changed in an area known to be nonhazardous.
- 

**Informations sur l'utilisation de cet équipement en environnements dangereux:**

---

Les produits marqués CL I, DIV 2, GP A, B, C, D ne conviennent que une utilisation en environnements de Classe I Division 2 Groupes A, B, C, D dangereux et non dangereux. Chaque produit est livré avec des marquages sur sa plaque d'identification qui indiquent le code de température pour les environnements dangereux. Lorsque plusieurs produits sont combinés dans un système, le code de température le plus défavorable (code de température le plus faible) peut être utilisé pour déterminer le code de température global du système. Les combinaisons d'équipements dans le système sont sujettes à inspection par les autorités locales qualifiées au moment de l'installation.

---

**AVERTISSEMENT****RISQUE D'EXPLOSION –**

- Couper le courant ou s'assurer que l'environnement est classé non dangereux avant de débrancher l'équipement.
  - Couper le courant ou s'assurer que l'environnement est classé non dangereux avant de débrancher les connecteurs. Fixer tous les connecteurs externes reliés à cet équipement à l'aide de vis, loquets coulissants, connecteurs filetés ou autres moyens fournis avec ce produit.
  - La substitution de composants peut rendre cet équipement inadapté à une utilisation en environnement de Classe 1, Division 2.
  - S'assurer que l'environnement est classé non dangereux avant de changer les piles.
-

## Specifications

	1771-P4R	1771-P6R
Input Voltage	120V ac, 50–60Hz, 1A	220V ac, 50–60Hz, 0.5A
Input Voltage Range	97–132V ac	194–240V ac
Module Location	1771-A1B, thru -A4B or later I/O chassis	
Output Voltage	5V dc, 8A (See Derating Curve)	
Maximum System Output Current at 60°C using N+1 Redundancy	8A (2 unit system) 14A (3 unit system) 20A (4 unit system)	
Power Dissipation	16 Watts (max.)	
Power Dissipation – adjacent slot	10 Watts (max.)	
Thermal Dissipation	47.8 BTU/hr (max.), 6.9 BTU/hr (min.)	
Backplane Current	300mA @ 5V dc $\pm$ 5%	
Isolation Voltage	Tested to withstand 1000V for 60s.	
Redundancy Cable	A–B pt. no. 941201–02	
Conductors	Wire Size	14 AWG (2.5mm <sup>2</sup> ) stranded copper rated at 60°C or greater 3/64 inch (1.2mm) insulation (max) 1 <sup>1</sup>
	Category	
Branch Circuit Protection <sup>2</sup>	15A maximum (user provided)	
Environmental Conditions		
Operating Temperature	IEC 60068–2–1 (Test Ad, Operating Cold) IEC 60068–2–2 (Test Bd, Operating Dry Heat) IEC 60068–2–14 (Test Nb, Operating Thermal Shock) 32 to 140°F (0° to 60°C)	
Storage Temperature	IEC 60068–2–1 (Test Ab, Unpackaged, Nonoperating Cold) IEC 60068–2–2 (Test Bb, Unpackaged, Nonoperating Dry Heat) IEC 60068–2–14 (Test Na, Unpackaged, Nonoperating Thermal Shock) –13 to 176°F (25 to 80°C)	
Relative Humidity	IEC 60068–2–30 (Test Db, Unpackaged, Nonoperating Damp Heat) 5 to 95%, noncondensing	
Shock	IEC 60068–2–27 (Test Ea, Unpackaged Shock)	
Operating	30g	
Nonoperating	50g	
Vibration	IEC 60068–2–6 (Test Fc, Operating) 2g @ 10–500Hz	
Enclosure Type Rating	None (open–style)	
Fuse	1.5A, 250V fuse – Bussman MDL 1.5, Littelfuse 31301.5, IEC 127 (blue)	
Wiring Blocks	ac power	A–B PN941274–55 (Wago PN231–002/027–000)
	alarm relay	A–B PN941274–03 (Wago PN231–203/000–008)
Weight	2 lbs. (0.85kg)	
Alarm Relay Rating	250V ac, 1/6 HP; 1A, 30V dc	
<b>Specifications continued on next page.</b>		

	1771-P4R	1771-P6R
Certifications (when product is marked)	UL UL Listed Industrial Control Equipment c-UL UL Listed for Class I, Division 2 Group A, B, C, D Hazardous Locations certified for Canada CE <sup>3</sup> European Union 89/336/EEC EMC Directive, compliant with: EN 50082-2, Industrial Immunity EN 61000-6-2, Industrial Immunity EN 61000-6-4, Industrial Emissions EN 61326; Meas./Control/Lab., Industrial Requirements European Union 73/23/EEC LVD Directive, compliant with: EN 61131-2, Programmable Controllers C-Tick <sup>3</sup> Australian Radiocommunications Act, compliant with: AS/NZS 2064, Industrial Emissions	

<sup>1</sup> You use this conductor category information for planning conductor routing as described in publication 1770-4.1, Industrial Automation Wiring and Grounding Guidelines.  
<sup>2</sup> Provided in all ungrounded mains connections.  
<sup>3</sup> See the Product Certification link at [www.ab.com](http://www.ab.com) for Declarations of Conformity, Certificates and other certification details

Derating Curve for the 1771-P4R, -P6R

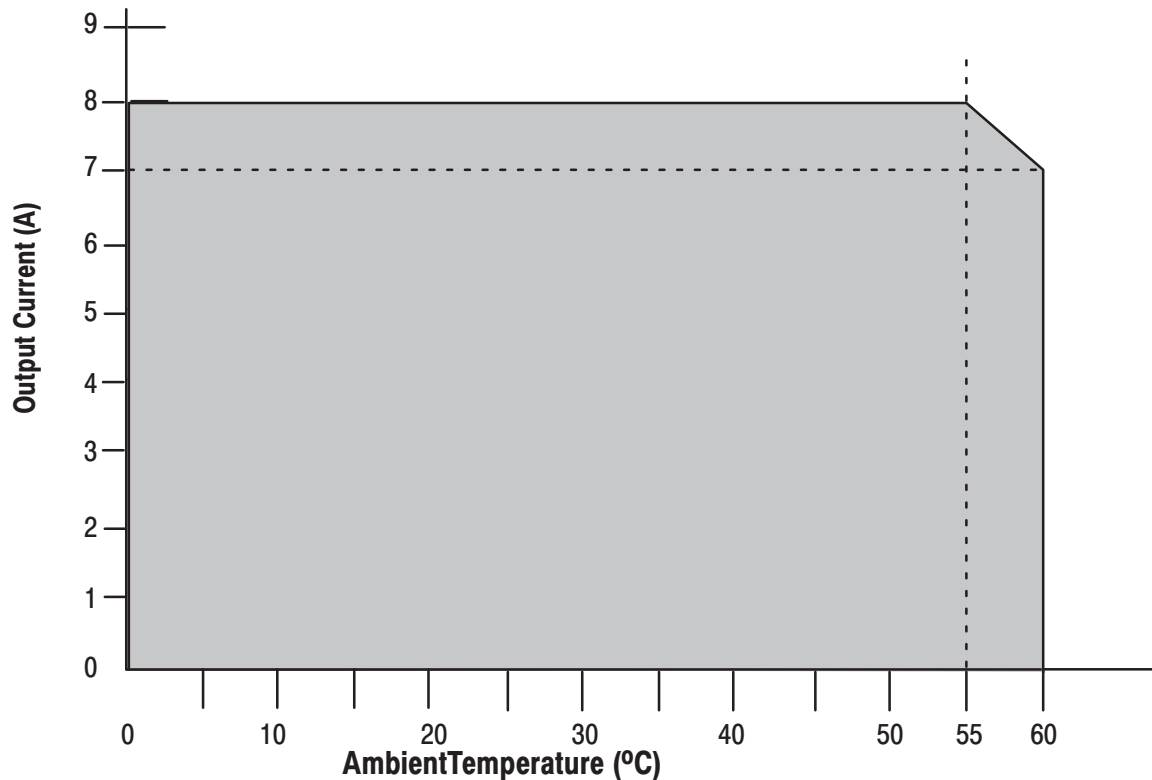



# Allen-Bradley Drives

**www.rockwellautomation.com****Corporate Headquarters**

Rockwell Automation, 777 East Wisconsin Avenue, Suite 1400, Milwaukee, WI 53202-5302 USA, Tel: (1) 414.212.5200, Fax: (1) 414.212.5201

**Headquarters for Allen-Bradley Products, Rockwell Software Products and Global Manufacturing Solutions**

**Americas:** Rockwell Automation, 1201 South Second Street, Milwaukee, WI 53204-2496 USA Tel: (1) 414.382.2000, Fax: (1) 414.382.4444

**Europe:** Rockwell Automation SA/NV, Vorstlaan/Boulevard du Souverain 36-BP 3A/B, 1170 Brussels, Belgium, Tel: (32) 2 663 0600, Fax: (32) 2 663 0640

**Asia Pacific:** Rockwell Automation, 27/F Citicorp Centre, 18 Whitfield Road, Causeway Bay, Hong Kong, Tel: (852) 2887 4788, Fax: (852) 2508 1846

**Headquarters for Dodge and Reliance Electric Products**

**Americas:** Rockwell Automation, 6040 Ponders Court, Greenville, SC 29615-4617 USA, Tel: (1) 864.297.4800, Fax: (1) 864.281.2433

**Europe/Middle East/Africa:** Rockwell Automation, Brühlstraße 22, D-74834 Elztal-Dallau, Germany, Tel: (49) 6261 9410, Fax: (49) 6261 1774

**Asia Pacific:** Rockwell Automation, 55 Newton Road, #11-01/02 Revenue House, Singapore 307987, Tel: (65) 351 6723, Fax: (65) 355 1733