



## **Allen-Bradley Power Supply Modules**

(cat. no. 1771-P4S, -P6S, -P4S1, -P6S1)

### **To the Installer**

This document provides you with the following information:

- what this package contains
- tasks on installing your power supply module
- interpreting the power supply indicators
- troubleshooting your power supply

### **What This Power Supply Package Contains**

When you receive your power supply, you should see the following components in the box:

- one 1771-P4S, -P6S, -P4S1, or -P6S1 power supply module
- one 5-position terminal block (attached to module)

### **Installing the Power Supply Module**

To install your power supply, you need to know how to perform the following tasks:

- set the jumpers
- place the power supply in a chassis
- connect a paralleling cable (if using a second supply)
- connect input power

#### **Set the Jumpers**

Each power supply module has two jumpers located at the back edge of the module near the gold-plated edge connectors. The jumper selection provides the proper voltage regulation for the different power supply configurations. The power supply can be configured to support local or remote sensing by setting the jumpers.

To configure the supply:

1. Position the power supply module so that the jumpers and pins are facing **upward** as shown in figure 1.

**Figure 1**  
**Power Supply Jumpers**

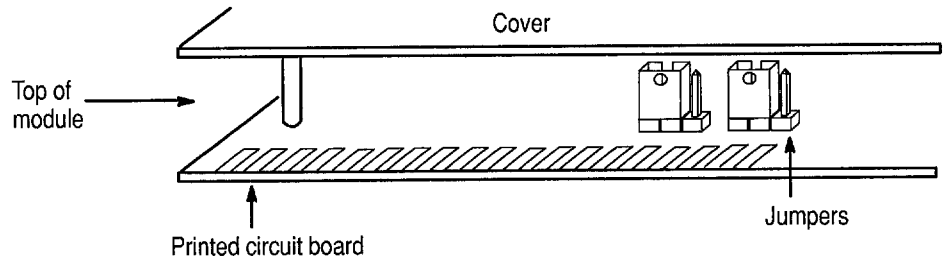

2. Set the jumpers as shown in table A. Use needle nose pliers to set the jumpers.

**Table A**  
**Jumper Settings**

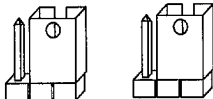
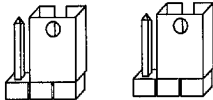
For This Configuration	Set Jumpers to:
A single power supply in a power-supply chassis connected to an I/O chassis through a power cable.	right position 
All other configurations. (Power supplies are shipped with jumpers in this position.)	left position 

**Place the Power Supply in a Chassis**



**WARNING:** Turn off all power-supply modules before removing modules from or inserting modules into a chassis. Failure to observe this warning could alter processor memory, damage module circuitry, and cause unintended operation which could possibly cause injury to personnel.

You can place these power-supply modules into any I/O module slot in any current chassis (1771-A1B, -A2B, -A3B, -A4B, -A3B1, -PSC).

However, to place these power-supply modules into a superseded I/O chassis (1771-A1, -A2, -A4), you must follow the restrictions in table B.

**Table B**  
**Placement Restrictions in Superseded I/O Chassis (1771-A1, -A2, -A4)**

Adapter or In-chassis processor	I/O Chassis	1st Power Supply <sup>1</sup>	2nd Power Supply <sup>1</sup>
Without an integral power supply	A4	I/O-slot 0	I/O-slot 10
	A2	I/O-slot 0	I/O-slot 4
	A1	I/O-slot 0	not applicable
With an integral power supply	A4	not applicable	I/O-slot 8
	A2	not applicable	I/O-slot 3

<sup>1</sup> I/O module slots are numbered 0 through 15, left to right.

### Connect a Paralleling Cable

You can use two power supplies in the same I/O chassis to produce more power by connecting them with a Power-Supply Paralleling Cable (1771-CT). This connection is for communication between the two supplies. If one supply has to shut down, it tells the second to turn off its indicator. Although the adapter or in-chassis processor will be disabled, the second supply will continue trying to operate until its DC output limits are exceeded. Because the adapter or in-chassis processor is disabled, paralleling two supplies does not provide redundancy.

To connect the paralleling cable:

1. Connect the paralleling cable between the **P/S PARALLEL** connectors on the two supplies (figure 2).
2. Loop the paralleling cable over the top of the I/O chassis to avoid picking up signals induced from I/O wiring.
3. Turn on the supplies simultaneously. If you don't, the first supply you turn on may shut down due to an overcurrent condition.

**Figure 2**  
**Paralleling Cable and AC Power Connections**

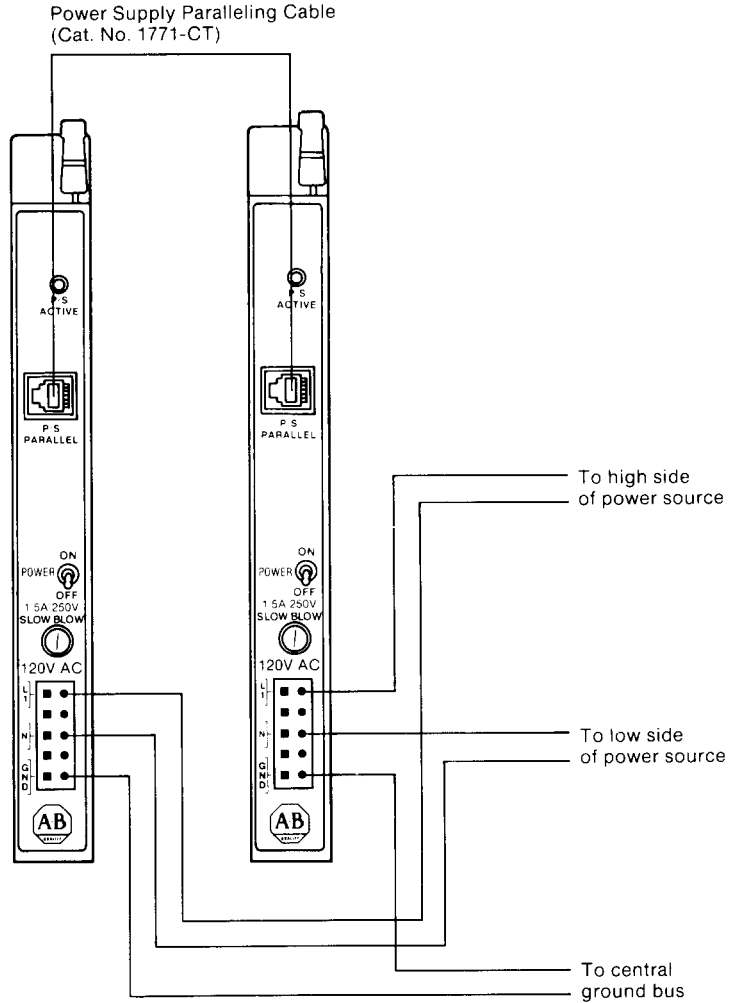

16855

### Connect Input Power

Figure 2 shows the overall configuration of the ac power connections.

To make ac power connections:

1. Connect the high side of the power source to the L1 terminal of the power supply.
2. Connect the low side of the power source to the L2 or N (neutral) terminal of the power supply.
3. Connect the GND (ground) terminal of the power supply to the central ground bus in the enclosure.

Figure 3 shows details of how to connect a wire to a terminal on the terminal block. You can connect these wires while the terminal block is plugged into the supply, or you can remove the block to lay it on a flat surface to connect these wires. To remove the block, pull it straight out out from the receptacle on the module.

The 2 undesignated terminals do not connect to any electrical circuit on the module and are not used. Each of the three functional terminals accepts a single 14-AWG wire max.

To connect a wire to a terminal:

1. Strip 0.35 inches of insulation off the wire.
2. Spring the clip open to insert the wire, using a wedge-tipped tool such as a small screwdriver. If you leave the terminal block plugged into the supply, insert the tool parallel to the wire (push straight in). If you remove the terminal block and lay it on a flat surface, insert the tool perpendicular to the wire (push straight down).
3. After making the wiring connections, re-insert the terminal block into the front plate. Be sure that the plug is completely inserted and that the locking prongs are engaged.

**Figure 3**  
Connecting a Wire to a Terminal

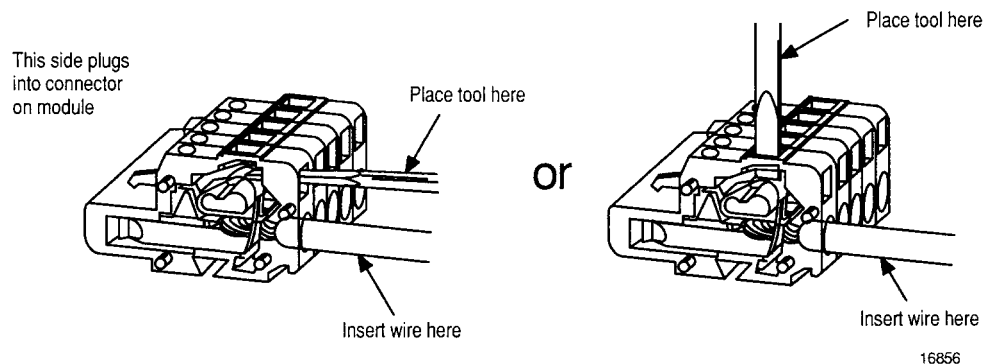

## Interpreting the Power Supply Indicators

Your power supply has an indicator located in the upper half of the module front panel labeled P/S ACTIVE. Table C shows how to interpret the P/S ACTIVE indicator.

**Table C**  
**Interpreting the P/S ACTIVE Indicator**

If the indicator is:	Then:
On	The power supply (and any supply connected through a paralleling cable) is operating normally. However, it could still have a poor connection to the backplane.
Off	<p>The supply has detected one of the following conditions:</p> <ul style="list-style-type: none"> <li>▪ dc overvoltage (the supply shuts down)</li> <li>▪ dc undervoltage (the supply shuts down)</li> <li>▪ dc overcurrent (the supply shuts down)</li> <li>▪ power switch turned off (the supply is turned off)</li> <li>▪ ac undervoltage</li> <li>▪ the paralleled supply is shut down</li> </ul> <p>With ac undervoltage or a paralleled supply shut down, the supply will attempt to generate the output. When dc limits are exceeded, the supply shuts down until you turn power off (for 5 seconds minimum) and then back on.</p>

### Troubleshooting a Single Power Supply

If you have a single power supply installed in an I/O chassis and its P/S ACTIVE indicator is off, verify the ground connection to the supply; then follow this troubleshooting flow chart.

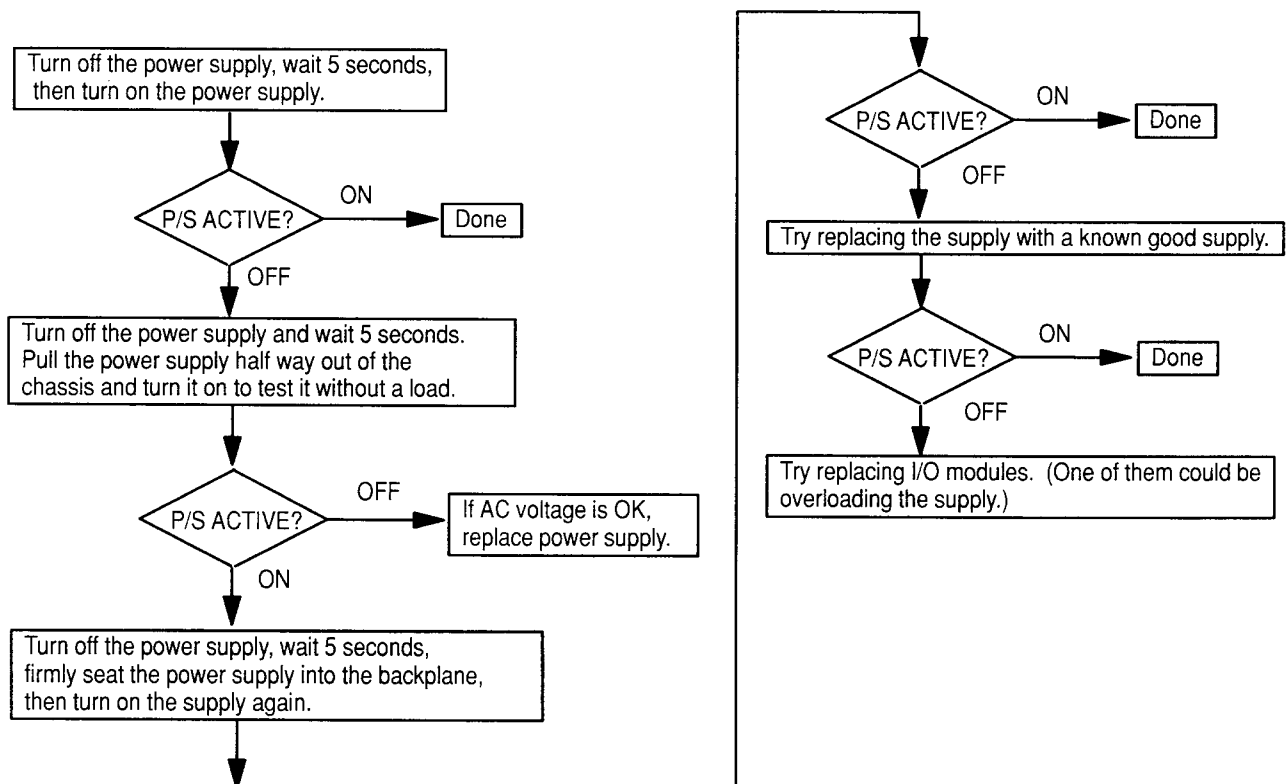

## Troubleshooting Parallel Power Supplies

If you have a pair of power supplies installed in parallel in an I/O chassis and the P/S ACTIVE indicators are off, verify the ground connection to each supply; then follow this troubleshooting flow chart.

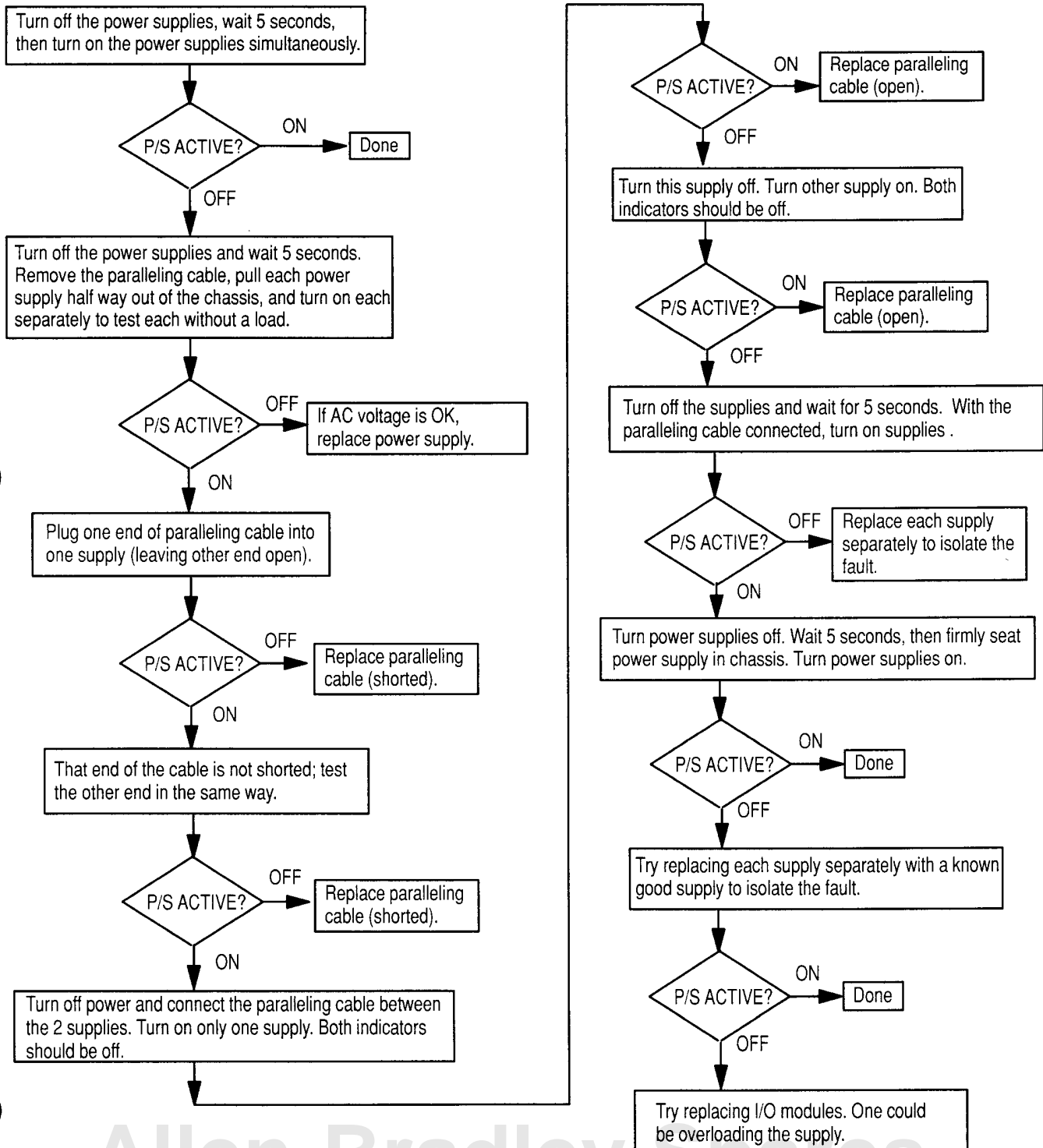

## Specifications

	1771-P4S	1771-P6S	1771-P4S1	1771-P6S1
Input Voltage	120V ac	220V ac	100V ac	200V ac
Input Range	97- 132V ac rms	194 – 264V ac rms	85 – 120V ac rms	170 – 240V ac rms
Frequency	47 – 63 Hz	47 – 63 Hz	47 – 63 Hz	47 – 63 Hz
Fuse	1.5A 250V Slow-blow			
Output Voltage (Backplane)	5V dc			
Output Current (max)	8A			
Wire Size	14 AWG max (single wire only)			
Environmental Conditions	Operational Temperature: 0 to 60°C (32 to 140 °F) Storage Temperature: -40 to 85° C (-40 to 185 °F) Relative Humidity: 5 to 95% (without condensation)			
Physical Width	1 I/O chassis slot			
Weight	1.85 lbs (0.84 kg)			
5-position Terminal Block	A-B P/N 941274-05, Wago 1 P/N 231-205/000-008 (1 included with each power supply)			

<sup>1</sup>Wago Corporation 9085 N. Deerbrook Trail, Brown Deer WI 53223



As a subsidiary of Rockwell International, one of the world's largest technology companies — Allen-Bradley meets today's challenges of industrial automation with over 85 years of practical plant-floor experience. More than 11,000 employees throughout the world design, manufacture and apply a wide range of control and automation products and supporting services to help our customers continuously improve quality, productivity and time to market. These products and services not only control individual machines but integrate the manufacturing process, while providing access to vital plant floor data that can be used to support decision-making throughout the enterprise.

### With offices in major cities worldwide

**WORLD HEADQUARTERS**  
Allen-Bradley  
1201 South Second Street  
Milwaukee, WI 53204 USA  
Tel: (1) 414 382-2000  
Telex: 43 11 016  
FAX: (1) 414 382-4444

**EUROPE/MIDDLE EAST/AFRICA HEADQUARTERS**  
Allen-Bradley Europe B.V.  
Amsterdamseweg 15  
1422 AC Uithoorn  
The Netherlands  
Tel: (31) 2975/43500  
Telex: (844) 18042  
FAX: (31) 2975/60222

**ASIA/PACIFIC HEADQUARTERS**  
Allen-Bradley (Hong Kong) Limited  
Room 1006, Block B, Sea View Estate  
28 Watson Road  
Hong Kong  
Tel: (852) 887-4788  
Telex: (780) 64347  
FAX: (852) 510-9436

**CANADA HEADQUARTERS**  
Allen-Bradley Canada Limited  
135 Dundas Street  
Cambridge, Ontario N1R 5X1  
Canada  
Tel: (1) 519 623-1810  
FAX: (1) 519 623-8930

**LATIN AMERICA HEADQUARTERS**  
Allen-Bradley  
1201 South Second Street  
Milwaukee, WI 53204 USA  
Tel: (1) 414 382-2000  
Telex: 43 11 016  
FAX: (1) 414 382-2400