



## ac (120V) Isolated Input Module

Cat. No. 1771-ID16GM

### Contents

Use this document as a guide when installing the ac Isolated Input module.

For information on:	See Page:
General Information	2
Understand compliance to European Union directives	2
Calculate power requirements	2
Initial handling	3
Set the filter time	3
Key the backplane connector	5
Install the module and field wiring arm	5
Connect the wiring to the module	6
Interpret the status indicators	8
Specifications	11



**ATTENTION:** The 1771-ID16GM isolated input module is designed specifically for **General Motors Corporation use only**. This module has specific input current requirements as outlined in the specifications at the end of this installation instruction.

For proper circuit operation:

- maximum input voltage is limited to 120V ac
- all inductive or solenoid input loads must provide external surge suppression

In addition, this module has been qualified for Bulletin 700P style 120V relay circuits **only**.

Use this module in a series B or later I/O chassis. The 1771-ID16GM is not compatible with the 1771-AL local I/O adapter.

# Allen-Bradley Motors

## General Information

This module contains customer-selectable input filtering to limit the effects of voltage transients caused by contact bounce and/or radiated electrical noise. The delay due to filtering is 9.0 or 18.0ms for turning ac inputs on to off, and 1.0ms for turning ac inputs off to on. The filter time is factory set to 9.0ms.

## Understand Compliance to European Union Directives

If this product has the CE mark it is approved for installation within the European Union and EEA regions. It has been designed and tested to meet the following directives.

### EMC Directive

This product is tested to meet Council Directive 89/336/EEC Electromagnetic Compatibility (EMC) and the following standards, in whole or in part, documented in a technical construction file:

- EN 50081-2EMC – Generic Emission Standard, Part 2 – Industrial Environment
- EN 50082-2EMC – Generic Immunity Standard, Part 2 – Industrial Environment

This product is intended for use in an industrial environment.

### Low Voltage Directive

This product is tested to meet Council Directive 73/23/EEC Low Voltage, by applying the safety requirements of EN 61131-2 Programmable Controllers, Part 2 – Equipment Requirements and Tests.

For specific information required by EN 61131-2, see the appropriate sections in this publication, as well as “Industrial Automation Wiring and Grounding Guidelines For Noise Immunity,” Allen-Bradley publication 1770-4.1

Open style devices must be provided with environmental and safety protection by proper mounting in enclosures designed for specific application conditions. See NEMA Standards publication 250 and IEC publication 529, as applicable, for explanations of the degrees of protection provided by different types of enclosure.

## Calculate Power Requirements

Your module receives its power through the 1771 I/O chassis backplane from the chassis power supply. The module requires 75mA from the output of this supply. Add this to the requirements of all other modules in the I/O chassis to prevent overloading the chassis backplane and/or backplane power supply.

## Initial Handling

The isolated input module is shipped in a static-shielded bag to guard against electrostatic discharge damage. Observe the following precautions when handling the module.

### Electrostatic Discharge Damage



**ATTENTION:** Under some conditions, electrostatic discharge can degrade performance or damage the module. Observe the following precautions to guard against electrostatic damage.

- Wear an approved wrist strap grounding device, or touch a grounded object to discharge yourself before handling the module.
- Do not touch the backplane connector or connector pins.
- If you configure or replace internal components, do not touch other circuit components inside the module. If available, use a static-free work station.
- When not in use, keep the module in a static-shielded bag.

## Set the Filter Time

The input module has 2 customer-selectable input filter time jumpers. Jumper JPR 1 sets the input filter time for inputs 00 through 07, and jumper JPR 2 sets the input filter time for inputs 10 through 17. These filter times apply when the input is cycling from ON to OFF. The OFF to ON filter time is fixed at 0.57ms. Refer to Table A for filter times and jumper settings.

**Important:** Half cycle dropout protection is dependent upon the position of the jumpers. With the jumpers at the 9.0ms position (Fast), half cycle protection may not be guaranteed. If half cycle dropout protection is required, position the jumpers in the 18.0ms position (Norm). Maximum and minimum filter times are shown in Table A.

To set the filtering time, proceed as follows:

1. Remove the side covers from the module circuit board by removing the four screws securing the covers to the module and remove the circuit board.
2. Position the jumpers as required to provide the filter time you require (see below). Use your fingers to pull the jumper up and position over the 2 pins corresponding to your selection (Fast or Norm).

### Setting the Filter Time Jumpers

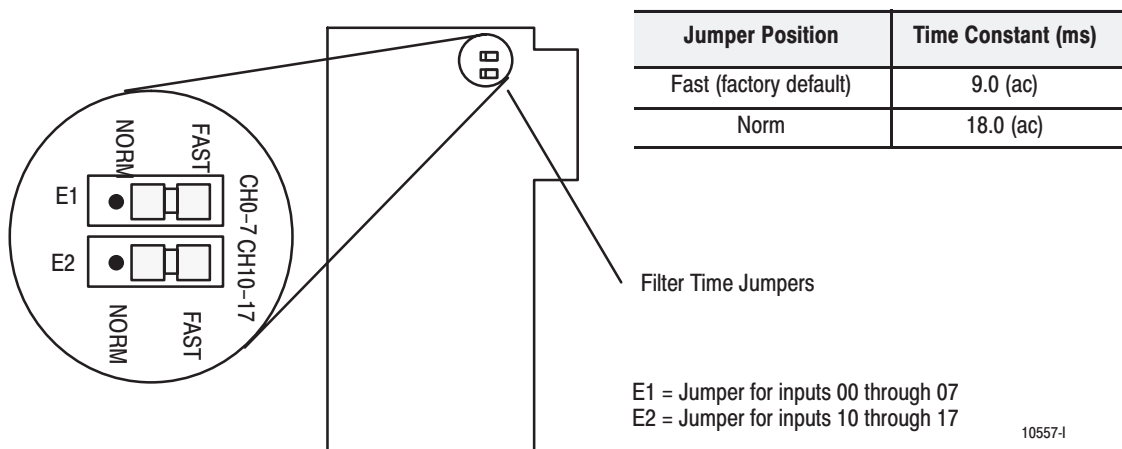

3. Reinstall the covers on the module circuit board and secure with 4 screws.

**Table A**  
Minimum and Maximum Filter Times

Input Voltage	Filter Time (msec)	Off to On (ms)			On to Off (ms)		
		Minimum	Maximum	Typical	Minimum	Maximum	Typical
ac	9.0	0.5	7.0	2.0	7.0	33	20
ac	18.0	0.5	8.1	2.0	14.0	42	29

## Key the Backplane Connector

Place your module in any slot in the chassis except the leftmost slot which is reserved for processors or adapters.



**ATTENTION:** Observe the following precautions when inserting or removing keys:

- insert or remove keys with your fingers
- make sure that key placement is correct

Incorrect keying or the use of a tool can result in damage to the backplane connector and possible system faults.

Position the keying bands in the backplane connectors to correspond to the key slots on the module.

Place the keying bands:  
between 22 and 24  
between 26 and 28

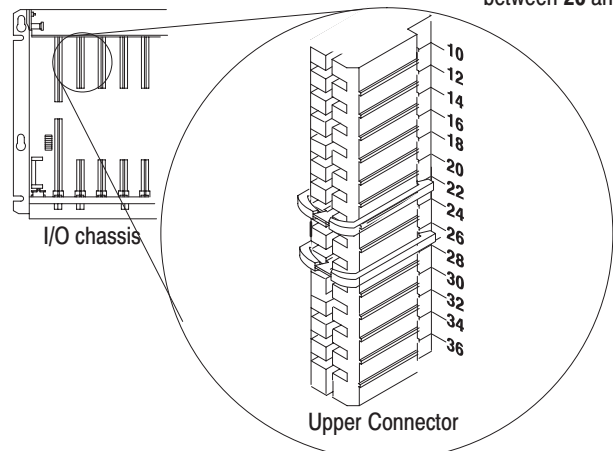

You can change the position of these bands if subsequent system design and rewiring makes insertion of a different type of module necessary.

11022-I

## Install the Module and Field Wiring Arm



**ATTENTION:** Remove power from the 1771 I/O chassis backplane and field wiring arm before removing or installing an I/O module.

- Failure to remove power from the backplane or wiring arm could cause module damage, degradation of performance, or injury.
- Failure to remove power from the backplane could cause injury or equipment damage due to possible unexpected operation.

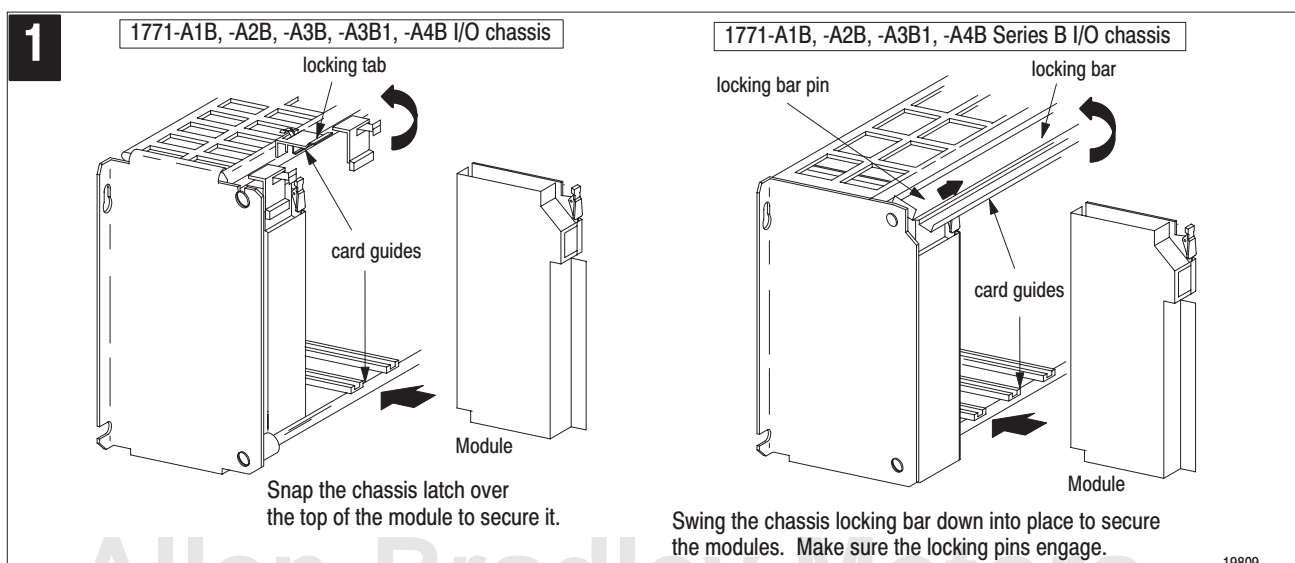

19809

Allen-Bradley Motors

**2**

Attach the wiring arm (1771-WN) to the horizontal bar at the bottom of the I/O chassis.

The wiring arm pivots upward and connects with the module so you can install or remove the module without disconnecting the wires.

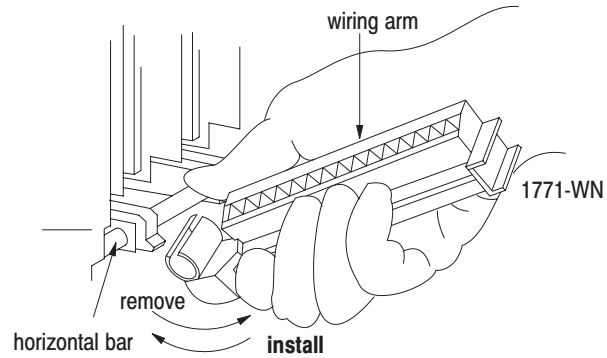

17643

## Connect the Wiring to the Module

Connections to the input module are made to the 40 terminal field wiring arm (cat. no. 1771-WN) shipped with the module. Attach the wiring arm to the pivot bar on the bottom of the I/O chassis. The wiring arm pivots upward and connects with the module so you can install or remove the module without disconnecting the wires.

1. Make certain all power is removed from the module before making wiring connections.
2. Swing the wiring arm up into position on the front of the module. The locking tab on the module will secure it into place.
3. Make your connections to the field wiring arm as shown in the following figure. (Use the label on the front of the wiring arm to identify your wiring.)

**Note:** A shorting bar may be used to connect the commons if channel-to-channel isolation is **not** required.



**ATTENTION:** The field wiring arm terminal identification number is not the same as the number of the bit associated with that input.

**Figure 1**  
**Connection Diagram for the 1771-ID16GM ac (120V) Isolated Input Module**

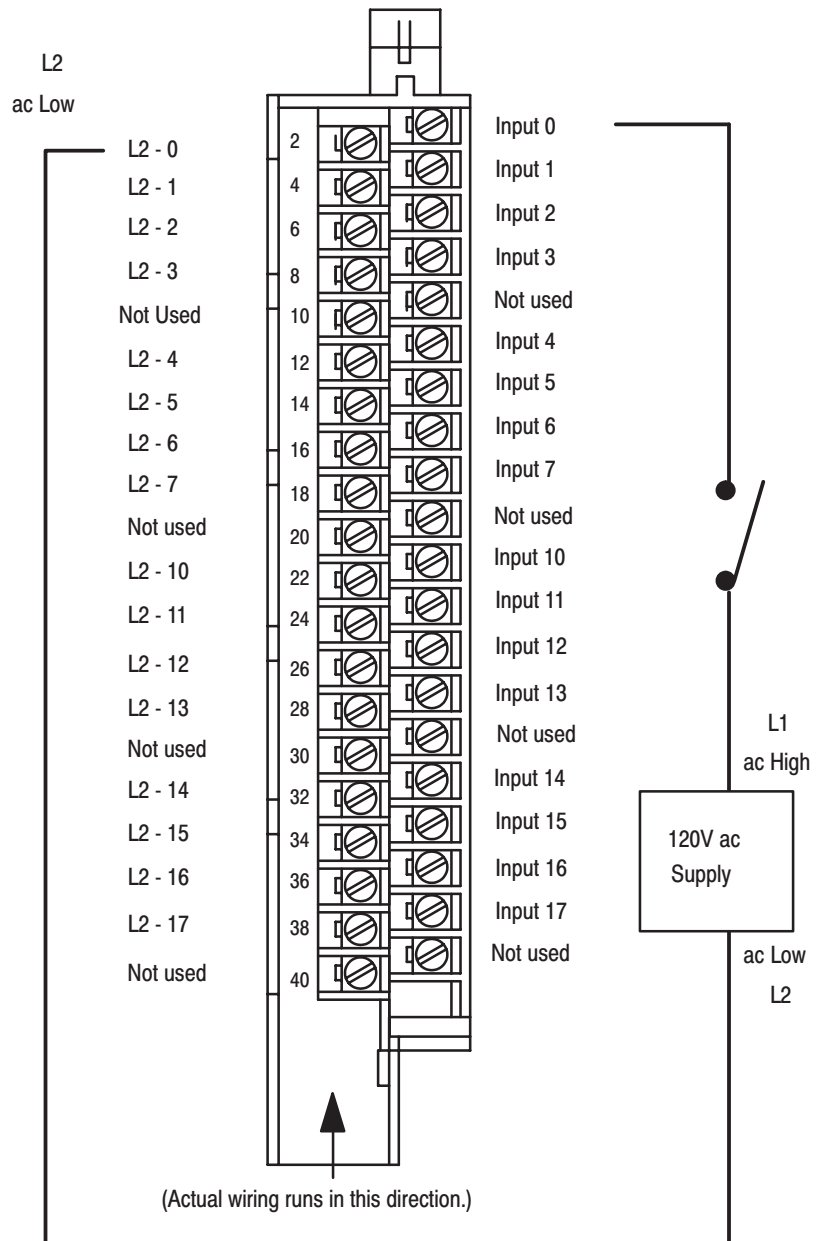

**ac Input**



**ATTENTION:** Maintain isolation between phases to prevent module damage.



**ATTENTION:** Do not use any 1771 ac output modules to drive the 1771-ID16GM input module.

Allen-Bradley Motors

## Interpreting the Status Indicators



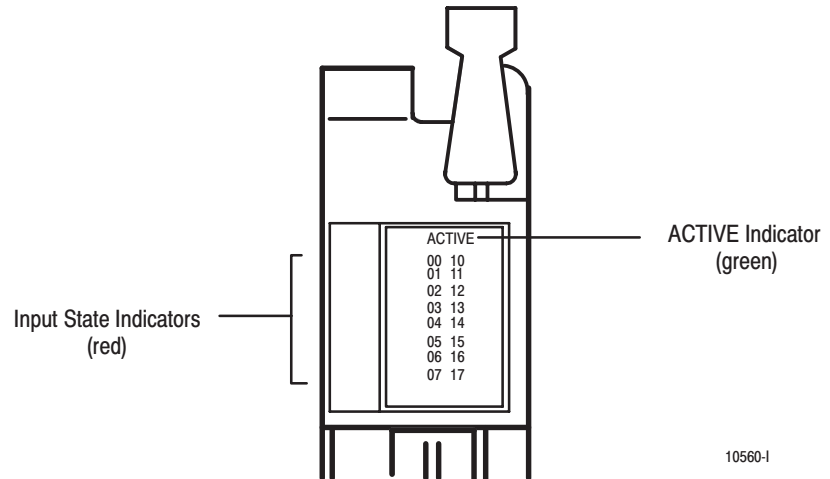

The module has 17 indicators (below), consisting of 16 input status indicators and an active indicator. The 16 status indicators will light when the field load has been applied to the field wiring arm of the module.



The active indicator will light when the module has successfully started up and has initialized.

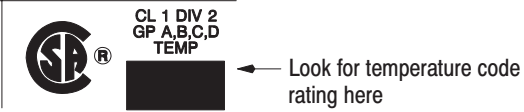
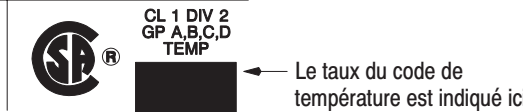

# Allen-Bradley Motors

CSA Hazardous Location Approval	Approbation d'utilisation dans des emplacements dangereux par la CSA
<p>CSA® certifies products for general use as well as for use in hazardous locations. <b>Actual CSA certification is indicated by the product label</b> as shown below, and not by statements in any user documentation.</p>	<p>La CSA® certifie les produits d'utilisation générale aussi bien que ceux qui s'utilisent dans des emplacements dangereux. <b>La certification CSA en vigueur est indiquée par l'étiquette du produit</b> et non par des affirmations dans la documentation à l'usage des utilisateurs.</p>
<p>Example of the CSA certification product label</p> 	<p>Exemple d'étiquette de certification d'un produit par la CSA</p> 
<p>To comply with CSA certification for use in hazardous locations, the following information becomes a part of the product literature for CSA-certified Allen-Bradley industrial control products.</p> <ul style="list-style-type: none"> <li>• This equipment is suitable for use in Class 1, Division 2, Groups A, B, C, D, or non-hazardous locations only.</li> <li>• The products having the appropriate CSA markings (that is, Class 1 Division 2, Groups A, B, C, D), are certified for use in other equipment where the suitability of combination (that is, application or use) is determined by the CSA or the local inspection office having jurisdiction.</li> </ul>	<p>Pour satisfaire à la certification de la CSA dans des endroits dangereux, les informations suivantes font partie intégrante de la documentation des produits industriels de contrôle Allen-Bradley certifiés par la CSA.</p> <ul style="list-style-type: none"> <li>• Cet équipement convient à l'utilisation dans des emplacements de Classe 1, Division 2, Groupes A, B, C, D, ou ne convient qu'à l'utilisation dans des endroits non dangereux.</li> <li>• Les produits portant le marquage approprié de la CSA (c'est à dire, Classe 1, Division 2, Groupes A, B, C, D) sont certifiés à l'utilisation pour d'autres équipements où la convenance de combinaison (application ou utilisation) est déterminée par la CSA ou le bureau local d'inspection qualifié.</li> </ul>
<p><b>Important:</b> Due to the modular nature of a PLC® control system, the product with the highest temperature rating determines the overall temperature code rating of a PLC control system in a Class 1, Division 2 location. The temperature code rating is marked on the product label as shown.</p>	<p><b>Important:</b> Par suite de la nature modulaire du système de contrôle PLC®, le produit ayant le taux le plus élevé de température détermine le taux d'ensemble du code de température du système de contrôle d'un PLC dans un emplacement de Classe 1, Division 2. Le taux du code de température est indiqué sur l'étiquette du produit.</p>
<p>Temperature code rating</p> 	<p>Taux du code de température</p> 
<p>The following warnings apply to products having CSA certification for use in hazardous locations.</p>	<p>Les avertissements suivants s'appliquent aux produits ayant la certification CSA pour leur utilisation dans des emplacements dangereux.</p>
 <p><b>WARNING:</b> Explosion hazard —</p> <ul style="list-style-type: none"> <li>• Substitution of components may impair suitability for Class 1, Division 2.</li> <li>• Do not replace components unless power has been switched off or the area is known to be non-hazardous.</li> <li>• Do not disconnect equipment unless power has been switched off or the area is known to be non-hazardous.</li> <li>• Do not disconnect connectors unless power has been switched off or the area is known to be non-hazardous. Secure any user-supplied connectors that mate to external circuits on an Allen-Bradley product using screws, sliding latches, threaded connectors, or other means such that any connection can withstand a 15 Newton (3.4 lb.) separating force applied for a minimum of one minute.</li> </ul>	 <p><b>AVERTISSEMENT:</b> Risque d'explosion —</p> <ul style="list-style-type: none"> <li>• La substitution de composants peut rendre ce matériel inacceptable pour les emplacements de Classe 1, Division 2.</li> <li>• Couper le courant ou s'assurer que l'emplacement est désigné non dangereux avant de remplacer les composants.</li> <li>• Avant de débrancher l'équipement, couper le courant ou s'assurer que l'emplacement est désigné non dangereux.</li> <li>• Avant de débrancher les connecteurs, couper le courant ou s'assurer que l'emplacement est reconnu non dangereux. Attacher tous connecteurs fournis par l'utilisateur et reliés aux circuits externes d'un appareil Allen-Bradley à l'aide de vis, loquets coulissants, connecteurs filetés ou autres moyens permettant aux connexions de résister à une force de séparation de 15 newtons (3,4 lb. - 1,5 kg) appliquée pendant au moins une minute.</li> </ul>

CSA logo is a registered trademark of the Canadian Standards Association  
PLC is a registered trademark of Allen-Bradley Company, Inc.

Le sigle CSA est la marque déposée de l'Association des Standards pour le Canada.  
PLC est une marque déposée de Allen-Bradley Company, Inc.

## Specifications

Inputs per Module	16
Module Location	1771-A1B thru -A4B or later I/O chassis; 1771-AM1, -AM2 chassis
Input Voltage Range	105–120V ac, 47-63Hz
Nominal Input Voltage	120V ac
Nominal Input Current	2.5mA ac
On State Voltage (minimum)	105V ac
On State Current (minimum)	2.0mA @ 105V ac
Off State Voltage (maximum)	66V ac
Off State Current (maximum)	0.8mA @ 66V ac
Input Signal Delay	Off to On On to Off
	0.57ms Selectable: 9ms or 18.0ms
Input Impedance (minimum)	75Kohms off, 48Kohms on
Power Dissipation	7.0 Watts (max.), 0.3 Watts (min.)
Thermal Dissipation	23.8 BTU/hr (max.), 1.0 BTU/hr (min.)
Backplane Current	75mA maximum
Tested Isolation Voltage	Tested to 1500V ac channel-to-channel for 1s; 1500V ac channel to backplane for 1s
Maximum Cable Length	1000ft (304.8m)
Environmental Conditions	
Operational Temperature	0° to 60°C (32° to 140°F)
Storage Temperature	-40° to 85°C (-40° to 185°F)
Relative Humidity	5 to 95% (without condensation)
Conductors	Wire Size
	14 to 22 gauge (2.5mm <sup>2</sup> to 0.25mm <sup>2</sup> ) stranded or solid copper only <sup>1,2</sup>
	3/64 inch (1.2mm) insulation maximum
	Category
	<sup>13</sup>
Keying	Between 22 and 24 Between 26 and 28
Wiring Arm	Catalog Number 1771-WN
Wiring Arm Screw Torque	9 pound-inches (1.0Nm)
Agency Certification (when product is marked)	<ul style="list-style-type: none"> <li>• CSA certified</li> <li>• CSA Class 1, Division 2, Groups A, B, C and D certified</li> <li>• UL listed</li> <li>• CE marked for all applicable directives</li> <li>• C-Tick marked for all applicable acts</li> </ul>

<sup>1</sup> One or two 14–22 AWG solid or stranded copper wires per terminal. Must be same size. Do not intermix solid and stranded wires. Use copper wire only.

<sup>2</sup> 14 gauge wire connected to all terminals may not allow the field wiring arm cover to close. A smaller wire size may be required.

<sup>3</sup> Refer to publication 1770-4.1, "Industrial Automation Wiring and Grounding Guidelines for Noise Immunity."



Allen-Bradley, a Rockwell Automation Business, has been helping its customers improve productivity and quality for more than 90 years. We design, manufacture and support a broad range of automation products worldwide. They include logic processors, power and motion control devices, operator interfaces, sensors and a variety of software. Rockwell is one of the world's leading technology companies.



## Worldwide representation.

Argentina • Australia • Austria • Bahrain • Belgium • Brazil • Bulgaria • Canada • Chile • China, PRC • Colombia • Costa Rica • Croatia • Cyprus • Czech Republic • Denmark • Ecuador • Egypt • El Salvador • Finland • France • Germany • Greece • Guatemala • Honduras • Hong Kong • Hungary • Iceland • India • Indonesia • Ireland • Israel • Italy • Jamaica • Japan • Jordan • Korea • Kuwait • Lebanon • Malaysia • Mexico • Netherlands • New Zealand • Norway • Pakistan • Peru • Philippines • Poland • Portugal • Puerto Rico • Qatar • Romania • Russia-CIS • Saudi Arabia • Singapore • Slovakia • Slovenia • South Africa, Republic • Spain • Sweden • Switzerland • Taiwan • Thailand • Turkey • United Arab Emirates • United Kingdom • United States • Uruguay • Venezuela • Yugoslavia

Allen-Bradley Headquarters, 1201 South Second Street, Milwaukee, WI 53204 USA, Tel: (1) 414 382-2000 Fax: (1) 414 382-4444