



ALLEN-BRADLEY

Temperature Control Module

(Cat. No. 1771-TCM)

(For Barrel Temperature Control Applications)

User Manual

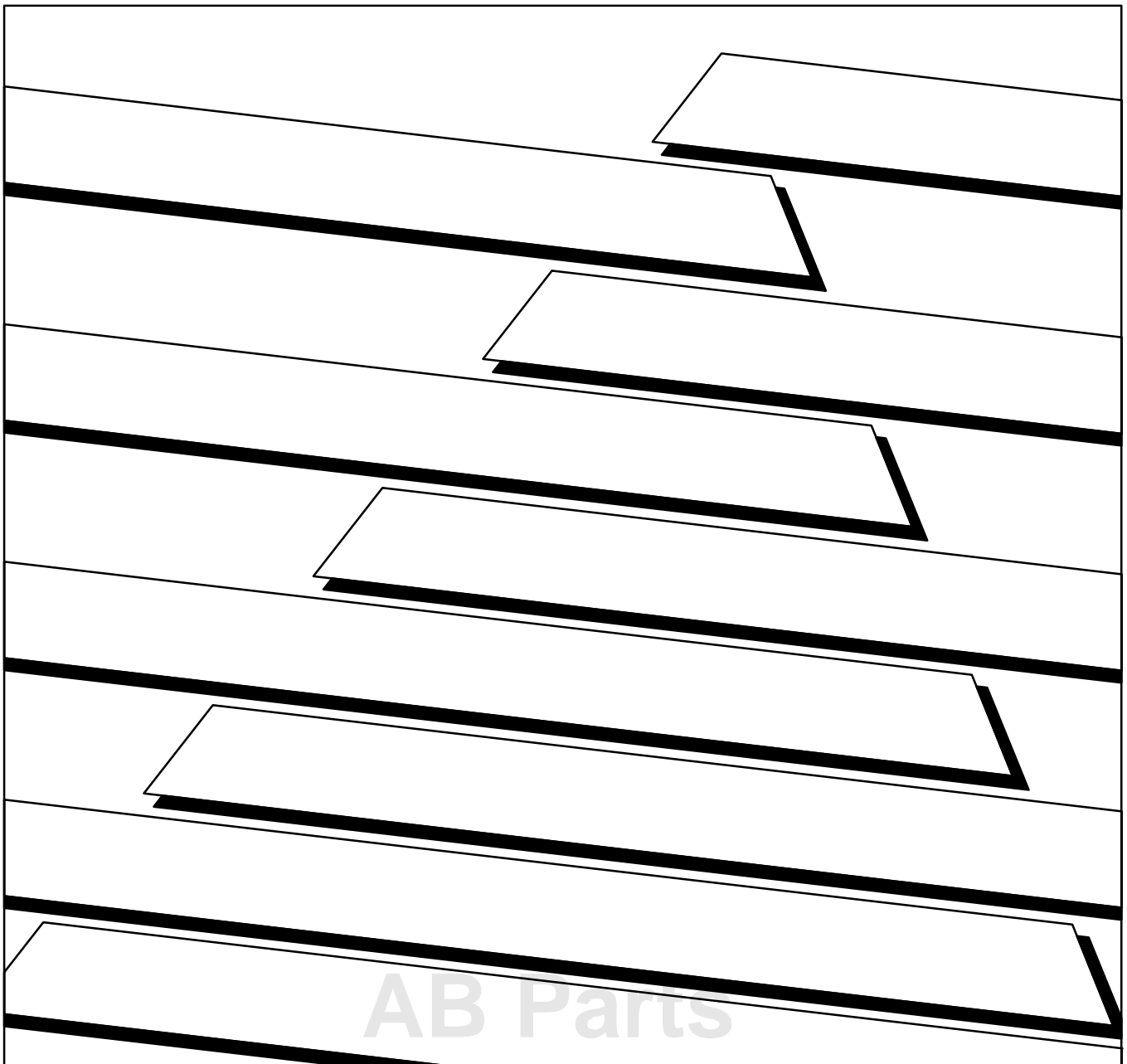

Important User Information

Because of the variety of uses for the products described in this publication, those responsible for the application and use of this control equipment must satisfy themselves that all necessary steps have been taken to assure that each application and use meets all performance and safety requirements, including any applicable laws, regulations, codes and standards.

The illustrations, charts, sample programs and layout examples shown in this guide are intended solely for purposes of example. Since there are many variables and requirements associated with any particular installation, Allen-Bradley does not assume responsibility or liability (to include intellectual property liability) for actual use based upon the examples shown in this publication.

Allen-Bradley publication SGI-1.1, *Safety Guidelines for the Application, Installation, and Maintenance of Solid-State Control* (available from your local Allen-Bradley office), describes some important differences between solid-state equipment and electromechanical devices that should be taken into consideration when applying products such as those described in this publication.

Reproduction of the contents of this copyrighted publication, in whole or in part, without written permission of Allen-Bradley Company, Inc., is prohibited.

Throughout this manual we use notes to make you aware of safety considerations:



ATTENTION: Identifies information about practices or circumstances that can lead to personal injury or death, property damage or economic loss.

Attention statements help you to:

- identify a hazard
- avoid the hazard
- recognize the consequences

Important: Identifies information that is critical for successful application and understanding of the product.

PLC, PLC-2, PLC-3, and PLC-5 are registered trademarks of Allen-Bradley Inc., a Rockwell International company.

Pro-Set is a trademarks of Allen-Bradley Inc., a Rockwell International company.

Table of Contents

Using this Manual	<u>i</u>
Related Publications	<u>ii</u>
Overview of the Temperature Control Module	<u>1-1</u>
Chapter Objectives	<u>1-1</u>
PID Loops for Temperature Control	<u>1-1</u>
Features of the Temperature Control Module	<u>1-2</u>
How the Temperature Control Module Communicates with Processors	<u>1-3</u>
What to do next	<u>1-4</u>
Installing the Module	<u>2-1</u>
Chapter Objectives	<u>2-1</u>
Before You Install Your 1771-TCM Module	<u>2-1</u>
Electrostatic Damage	<u>2-1</u>
Calculating Backplane Current Load for the I/O Chassis	<u>2-2</u>
Determine I/O Chassis Addressing Mode	<u>2-2</u>
Determining Module Location in the I/O Chassis	<u>2-2</u>
Determining Remote Termination Panel Location	<u>2-2</u>
Plan for Sufficient Enclosure Depth	<u>2-2</u>
Keying the I/O Chassis for Your Module	<u>2-3</u>
Connecting Thermocouples to the Remote Termination Panel	<u>2-7</u>
Grounding the Shields	<u>2-9</u>
Interpreting the Indicator Lights	<u>2-10</u>
What to do next	<u>2-10</u>
Communicating With Your Module	<u>3-1</u>
Chapter Objectives	<u>3-1</u>
I/O Image	<u>3-1</u>
Communication Sequence	<u>3-2</u>
Single-Transfer Programming	<u>3-3</u>
Block Transfer Programming	<u>3-8</u>
Module Update Period	<u>3-11</u>
What to do next	<u>3-11</u>

Configuring the Module	4-1
Chapter Objectives	4-1
Block Identification	4-1
Thermocouple Break Detection	4-1
Thermal Runaway Detection	4-1
Alarm Dead Band	4-2
Inferred Decimal Point	4-2
Configuration Block	4-3
What to do next	4-5
Setting Gains	5-1
Chapter Objectives	5-1
Sequence of Block-Transfers	5-1
Auto-tuning the Loops	5-1
Fine-tuning the Loops	5-2
Block Identification	5-2
Inferred Decimal Point	5-2
Gains Block	5-3
What to do next	5-5
Operating the Module	6-1
Chapter Objectives	6-1
Sequence of Block-transfers	6-1
Block Identification	6-1
Inferred Decimal Point	6-1
Dynamic Block	6-2
What to do next	6-7
Monitoring Status Data	7-1
Chapter Objectives	7-1
Sequence of Block-transfers	7-1
Block Identification	7-1
Implied Decimal Point	7-1
System Status Block	7-2
What to do next	7-23
Calibrating the Module	8-1
Chapter Objective	8-1
Tools and Equipment	8-1
When to Calibrate	8-1
Indicator Operation During Calibration	8-1
Preparing to Calibrate	8-1
Calibration Write Block	8-2

Calibration Read Block	8-3
Calibration Procedure	8-5
What to do next	8-6
Troubleshooting	9-1
Chapter Objective	9-1
Diagnostics Reported by the Module	9-1
Troubleshooting with the Indicators	9-2
Status Reported by the Module	9-2
Specifications	A-1
Locating Errors	B-1
Example Ladder Logic Program	C-1
Appendix Objectives	C-1
Abbreviations	C-1
Program Files	C-2
Data Table Layout	C-2
Ladder Logic Listing	C-6
Saving Auto-Tuning Parameter Values	D-1
Appendix Objectives	D-1
Sequence of Block-Transfers	D-1
Auto-Tuning Status/Command Block	D-2

Using this Manual

Purpose of Manual

This manual shows you how to use your Temperature Control Module (cat. no. 1771-TCM) with an Allen-Bradley programmable controller and Pro-Set™ 700 software for barrel temperature control applications. It helps you install, program, calibrate, and troubleshoot your module.

Audience

You must be able to program and operate an Allen-Bradley programmable controller to make efficient use of your barrel temperature control module. In particular, you must know how to program block-transfer instructions. If you do not, refer to the appropriate PLC® programming manual before you attempt to generate a program for this module.

System Compatibility

System compatibility involves data table use as well as compatibility with I/O chassis, remote termination panels, and processors.

Data Table Use

Communication between the module and the processor is bi-directional. The processor single-transfers output data through the output image table to the module and single-transfers input data from the module through the input image table. The module also requires an area in the data table to store the block-transfer read and write data. I/O image table use is an important factor in module placement and addressing selection. The module's data table use is listed in the following table.

Catalog Number	Use of Data Table				Compatibility			
	Input Image Bits	Output Image Bits	Read-Block Words	Write-Block Words	Addressing			Chassis
					1/2-slot	1-slot	2-slot	
1771-TCM	16	16	135	295 max	Yes	R	No	B

B = Compatible with 1771-A1B, A2B, A3B, A3B1, A4B, 1771-AM1, -AM2 chassis.

Yes = Compatible without restriction

R = Restricted compatibility; it cannot be in the same even/odd pair of slots with a 32-bit module

No = Not compatible

You can place your 1771-TCM module into any I/O module slot of the I/O chassis. However, do not put the 1771-TCM module into the same even/odd module-slot pair as a 32-bit-density module unless you are using 1/2-slot addressing.

I/O Chassis

This module can only be used in 1771-A1B, A2B, A3B, A3B1, A4B, -AM1, and -AM2 chassis.

Remote Termination Panel

The 1771-TCM module is compatible with the 1771-RTP1 remote termination panel.

Processor

Because it passes integer values in natural binary format, the 1771-TCM module is not compatible with PLC-2® processors. However, the 1771-TCM module is compatible with PLC-3®, 1785 PLC-5®, and PLC-5/250 processors.

Vocabulary

In this manual, we refer to:

- the temperature control module as the “1771-TCM module” or as the “module”
- the programmable controller processor, as the “PLC processor” or the “processor”
- a thermocouple as a “TC”
- a time-proportioned output as “TPO”

Related Publications

For a list of publications with information on Allen-Bradley programmable controller products, consult our publication index SD499.

Manual Organization

This manual has 9 chapters.

Chapter	Title	Topics Covered
1	Overview of the Temperature Control Module	Module function, its hardware features, its communication with the PLC processor, and auto-tuning
2	Installing the Module	Module power requirements, keying, chassis location Wiring of module and remote termination panel
3	Communicating with Your Module	How to generate ladder logic to provide for the necessary single-transfer and block-transfer communication with this module — sample program rungs
4	Configuring the Module	Hardware and software configuration Configuration block format
5	Setting Gains	Gains block format Auto-tuning the loops Fine-tuning the loops
6	Operating the Module	Dynamic block format
7	Monitoring Status Data	Sequence of block-transfers System-status-block format
8	Module Calibration	How to calibrate your modules
9	Troubleshooting	Diagnostics reported by the module
Appendix A	Specifications	Your module's specifications
Appendix B	Locating Errors	The meanings of error codes the module may return in the system status block
Appendix C	Example Ladder Logic Program	A program that can be used in testing the module, and in generating a program for your application

Overview of the Temperature Control Module

Chapter Objectives

This chapter gives you information on:

- the function of the barrel temperature control module
- features of the barrel temperature control module
- how the module communicates with PLC processors

PID Loops for Temperature Control

The temperature control module is an intelligent I/O module that can provide a maximum of 8 PID loops for temperature control. The module has 8 analog inputs. Each analog input functions as the process variable (PV) for a PID loop. The PID algorithm is performed on the module for each of the loops. The control-variable (CV) output of each loop is sent from the module to the PLC data table. The ladder logic must send the control variable to an output module to close the loop.

Figure 1.1
A 1771-TCM Module with 8 PID Logic Channels, showing one complete PID Loop

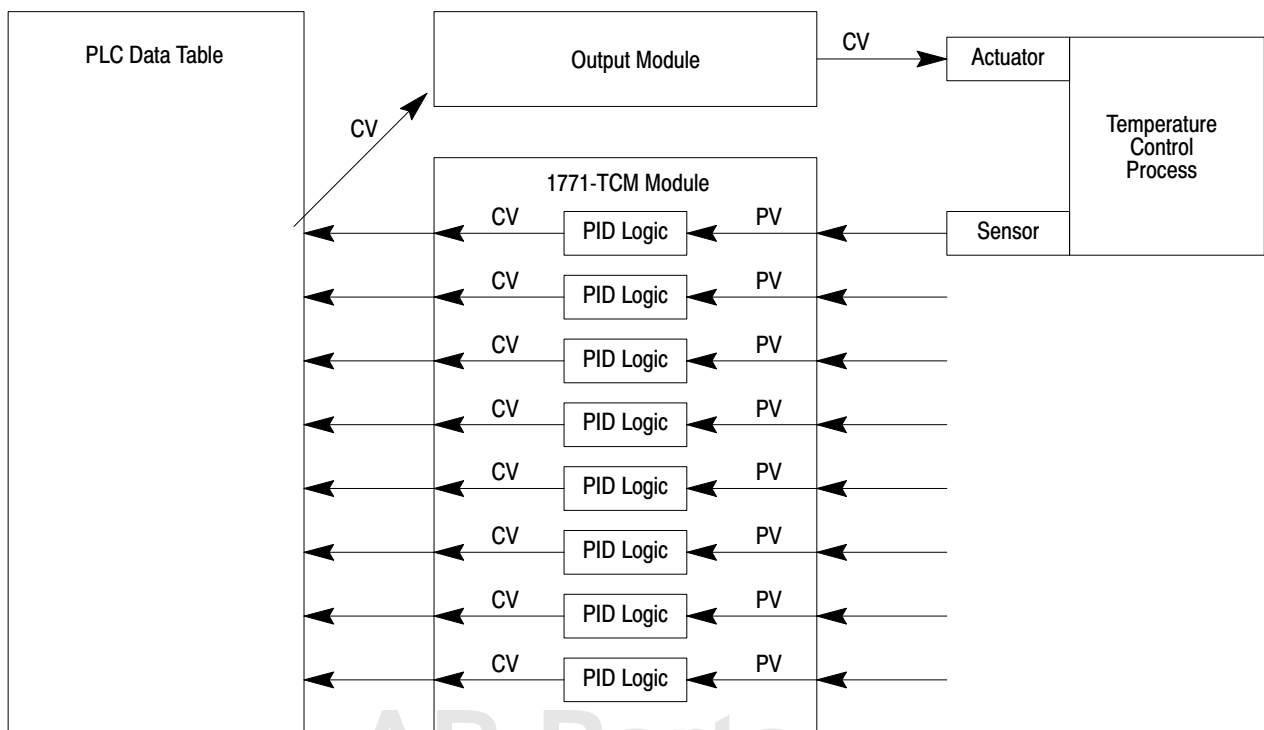

AB Parts

The control-variable output of each loop is sent from the 1771-TCM module to the PLC data table as a numeric value. The ladder logic can monitor this numeric value as well as send it to an analog output module to generate the control variable output signal to the temperature control actuator.

The control-variable output of each loop is also sent from the 1771-TCM module to the PLC data table as the duty cycle of a bit that is cycled at a regular period. We call this bit a time-proportioned output (TPO) bit. The ladder logic can send this signal to a digital output module to generate the control variable output signal to the temperature control actuator.

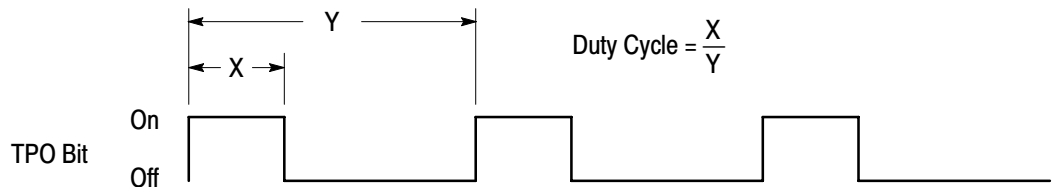

Features of the Temperature Control Module

The 1771-TCM module provides:

- 8 PID loops
- auto-tuning of PID loops
- a thermocouple input ($\pm 100\text{mV}$) for each PID loop
- 16-bit analog-to-digital converter resolution
- a heat signal (for each PID loop) to the data table as a numeric value
- a cool signal (for each PID loop) to the data table as a numeric value
- a heat signal (for each PID loop) to the data table as a TPO bit
- a cool signal (for each PID loop) to the data table as a TPO bit
- temperature values in $^{\circ}\text{C}$ or $^{\circ}\text{F}$
- self-calibration (external reference required)
- software configuration
- user-selectable high and low alarms with dead band for hysteresis
- self diagnostics
- input open-circuit detection

How the Temperature Control Module Communicates with Processors

The barrel temperature control module communicates with the PLC processor by both block-transfer and single-transfer. The ladder logic must include block-transfer write instructions to send the following data blocks to the module:

- a configuration block for each PID loop (8 max)
- gains block
- dynamic block
- calibration block (not required for normal operation)

The ladder logic must include block-transfer read instructions to get the following data blocks from the module:

- system status
- gains block
- calibration block (not required for normal operation)

The ladder logic must also include instructions for dealing with an input image byte single-transferred from the module. This byte contains the control-variable output of each loop as the duty cycle of a bit that is cycled at a regular period. Each bit represents one of the 8 PID loops.

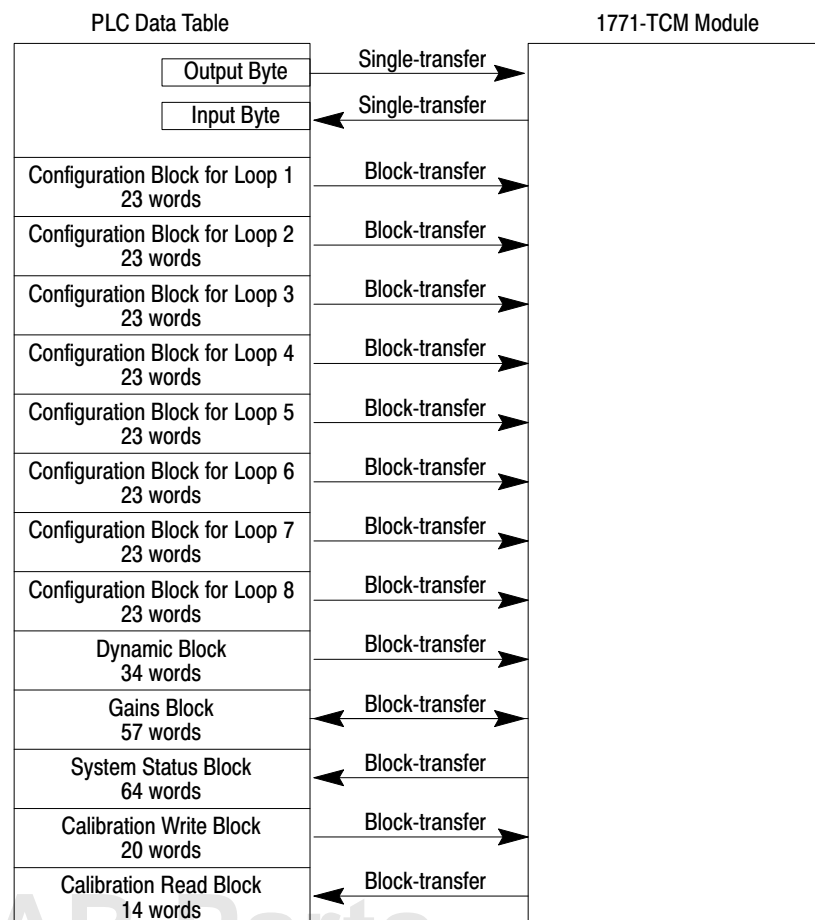

AB Parts

Chapter 1

Introduction to the Temperature Control Module

What to do next

To learn how to install the temperature control module, read chapter 2.

Installing the Module

Chapter Objectives

This chapter gives you information on:

- calculating the chassis power requirement
- choosing the module's location in the I/O chassis
- keying a chassis slot for your module
- installing the module
- connecting the cable and making wiring connections to the remote termination panel

Before You Install Your 1771-TCM Module

Before installing your module in the I/O chassis you must:

Action required:	Refer to:
Calculate power requirements for the I/O chassis.	page 2-2
Determine module location in the I/O Chassis	page 2-2
Determine remote termination panel location	page 2-2
Plan for sufficient enclosure depth	page 2-2
Key the I/O chassis for your module	page 2-3

Electrostatic Damage

Electrostatic discharge can damage semiconductor devices inside this module if you touch backplane connector pins. Guard against electrostatic damage by observing the following warning:



ATTENTION: Electrostatic discharge can degrade performance or cause permanent damage. Handle the module as stated below.

- Wear an approved wrist-strap grounding device when handling the module.
- Touch a grounded object to rid yourself of electrostatic charge before handling the module.
- Handle the module from the front, away from the backplane connector. Do not touch backplane connector pins.
- Keep the module in its static-shield bag when not in use, or during shipment.

Calculating Backplane Current Load for the I/O Chassis

Your module receives its power through the 1771 I/O chassis backplane from the chassis power supply. The maximum backplane current load of the module is 1A.

Add this load to the loads of all other modules in the I/O chassis. This total must not exceed the chassis backplane or backplane power supply load specification.

Determine I/O Chassis Addressing Mode

Because the 1771-TCM module has a 16-I/O-bit density, you cannot use it in an I/O chassis set for 2-slot addressing. The 1771-TCM module is compatible with either 1-slot or $\frac{1}{2}$ -slot addressing.

Determining Module Location in the I/O Chassis

The extreme left slot is not an I/O module slot; it is reserved for processors or adapter modules.

- If you are using $\frac{1}{2}$ -slot addressing, you can place your module into any I/O module slot of the I/O chassis.
- If you are using 1-slot addressing, do not place the 1771-TCM module into the same even/odd module-slot pair as a 32-bit-density module. This module uses 2 bytes in the input image table and 2 bytes in the output image table.
- To minimize electrical noise interference, group analog and low-voltage dc digital modules away from ac modules or high voltage dc digital modules.

Determining Remote Termination Panel Location

Place your 1771-RTP1 remote termination panel within sufficiently close proximity to the module so that the distance is within the length of the interconnect cables you choose.

- The length of the 1771-NC6 cable is 1.8m (6 feet).
- The length of the 1771-NC15 cable is 4.6m (15 feet).

Plan for Sufficient Enclosure Depth

The cable connector sticks out from the front of the module. The enclosure must provide room for a total of 215 mm (8.5 inches) from the back-panel to the connector.

Keying the I/O Chassis for Your Module

Use the plastic keying clips shipped with each I/O chassis, for keying the I/O slot to accept only this type of module.



ATTENTION: Observe the following precautions when inserting or removing keying clips:

- insert or remove keying clips with your fingers
- make sure that keying placement is correct

Incorrect keying or the use of a tool can result in damage to the backplane connector and possible system faults.

I/O modules are slotted in two places on the rear edge of the circuit board. The position of the keys on the backplane connector must correspond to these slots to allow insertion of the module. You can key any I/O-module-slot connector in an I/O chassis to receive this module. Place keying clips between the following numbers labeled on the upper backplane connector (Figure 2.1):

- Between 26 and 28
- Between 32 and 34

You can change the position of these keys if subsequent system design and rewiring makes insertion of a different type of module necessary.

Figure 2.1
Keying Positions

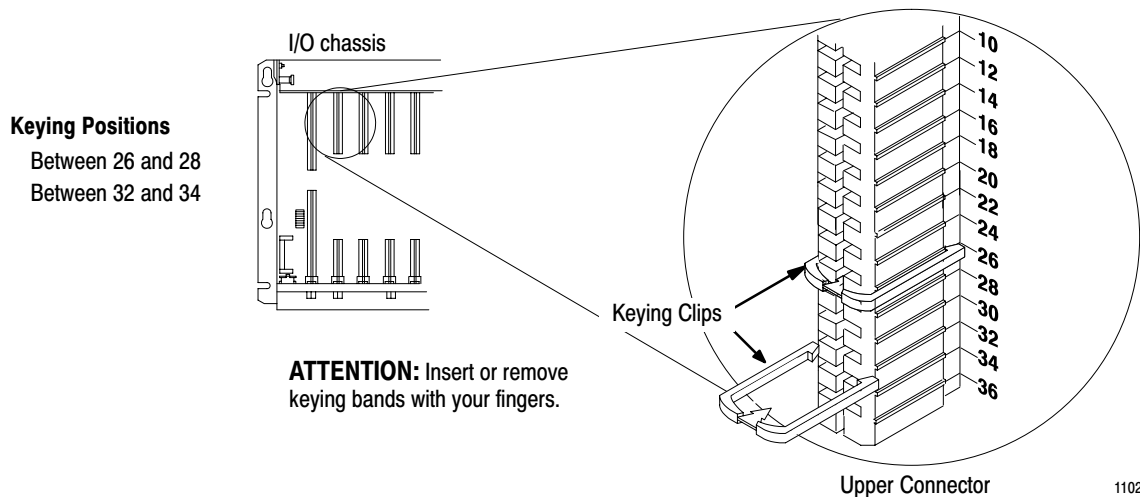

Installing the Module

When installing your module in an I/O chassis:

1. Turn off power to the I/O chassis:



ATTENTION: Remove power from the 1771 I/O chassis backplane and disconnect the cable from the module before removing or installing an I/O module.

Failure to remove power from the backplane could cause injury or equipment damage due to possible unexpected operation.

Failure to remove power from the backplane could cause module damage, degradation of performance, or injury.

2. Place the module in the plastic tracks on the top and bottom of the slot that guides the module into position.
3. Do not force the module into its backplane connector. Apply firm even pressure on the module to seat it properly.
4. Snap the chassis latch over the top of the module to secure it.

Installing the Remote Terminator Panel

For the temperature control module, you must use the 1771-RTP1 Remote termination panel. The remote termination panels are designed for mounting on standard DIN 1 or DIN 3 mounting rails. Mounting dimension are shown in Figure 2.2.

Figure 2.2
Mounting Dimensions for the 1771-RTP1 Remote Termination Panels

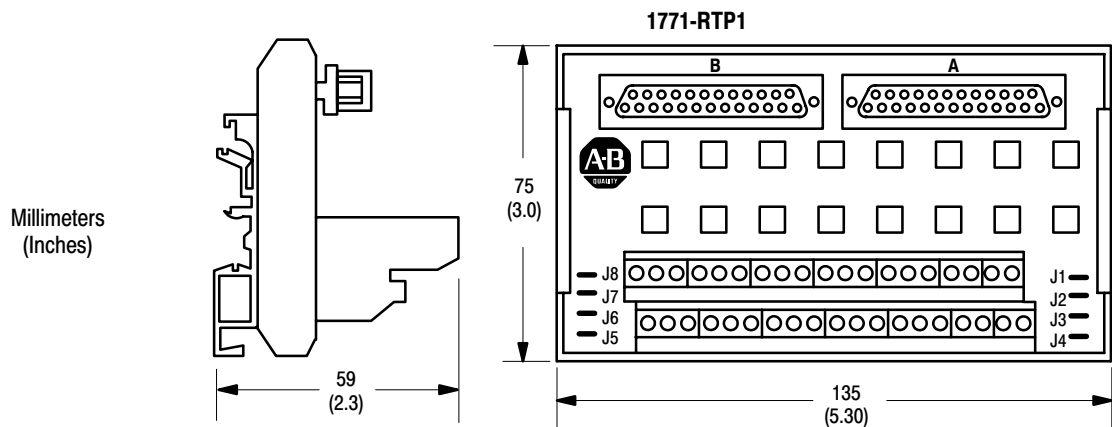

Installing the Cables

Connect the 1771-NC6 or -NC15 cable to the module as shown in Figure 2.3:

1. Slide the locking bar up.
2. Insert the cable connector into the mating connector on the front of the module.
3. Slide the locking bar down over the mating pins on the module to lock the connector onto the module.

Figure 2.3
Connecting the Cable to the Front of the Module

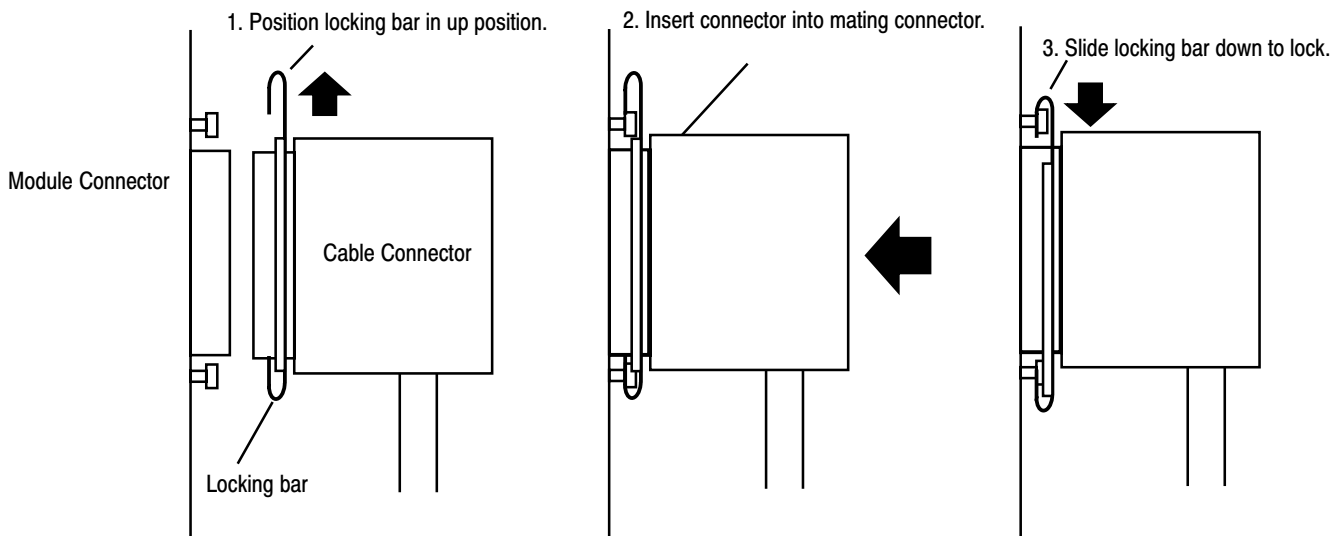

11023-I

Connect the other end of each cable to the remote termination panel. You need two cables per module. Connect one cable from the top connector on the module to the right connector on the panel. Connect the other cable from the bottom connector on the module to the left connector on the panel. At the panel, use the thumb screws to lock the connector in place. The proper orientation of the cables is shown in Figure 2.4.

Figure 2.4
Remote Termination Panel Wiring

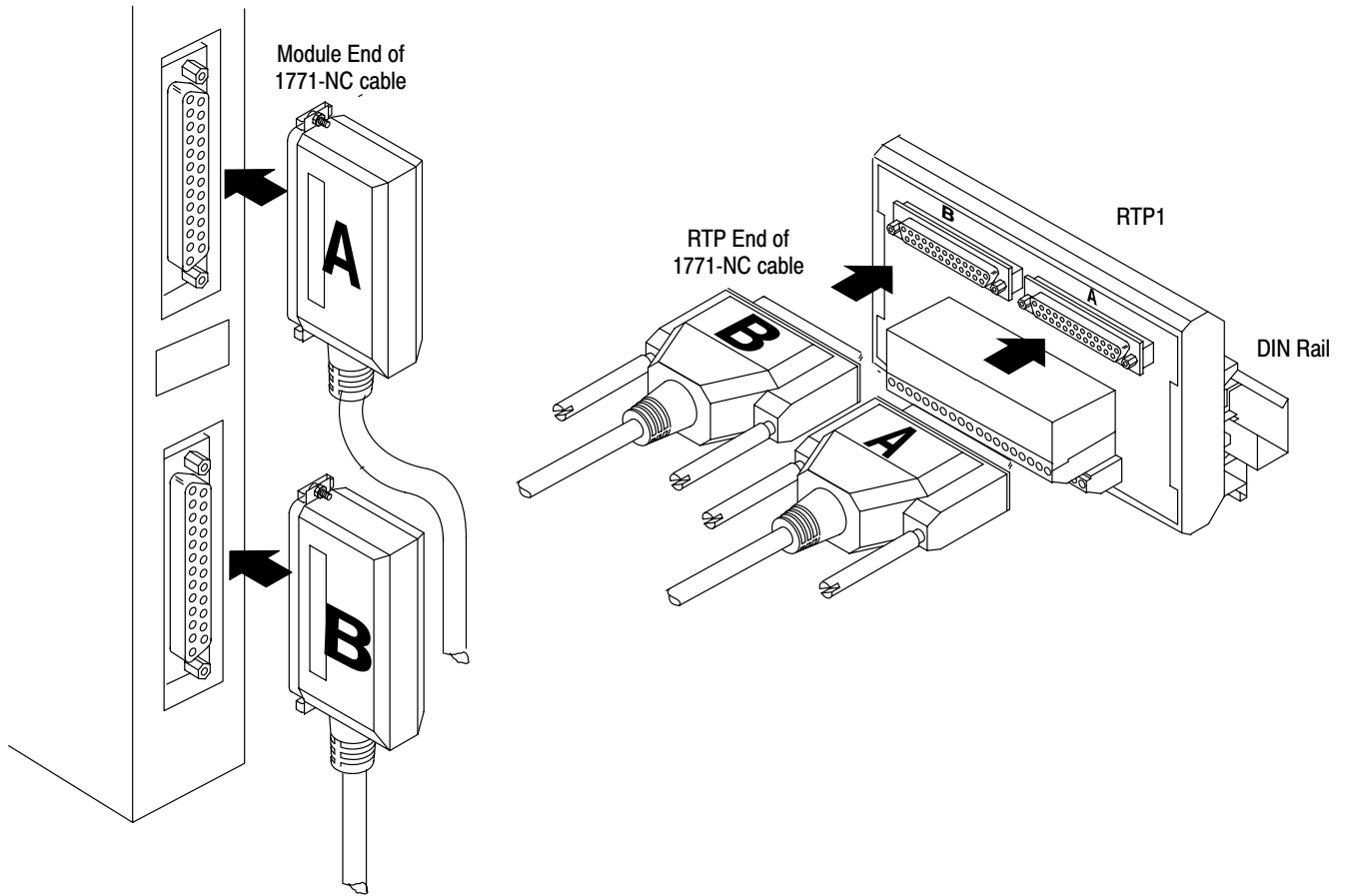

Connecting Thermocouples to the Remote Termination Panel

The remote termination panel has a set of 4 screw terminals for each PID loop input. However, one is unused.

PID Loop	Terminal Designation	Connect to:
1	I1	Input 1
	R1	Return 1
	S1	Shield 1
	O1	Not Used
2	I2	Input 2
	R2	Return 2
	S2	Shield 2
	O2	Not Used
3	I3	Input 3
	R3	Return 3
	S3	Shield 3
	O3	Not Used
4	I4	Input 4
	R4	Return 4
	S4	Shield 4
	O4	Not Used
5	I5	Input 5
	R5	Return 5
	S5	Shield 5
	O5	Not Used
6	I6	Input 6
	R6	Return 6
	S6	Shield 6
	O6	Not Used
7	I7	Input 7
	R7	Return 7
	S7	Shield 7
	O7	Not Used
8	I8	Input 8
	R8	Return 8
	S8	Shield 8
	O8	Not Used

The remote termination panel wiring terminals are shown in Figure 2.5.

Figure 2.5
Connecting Wire to the Remote Termination Panel

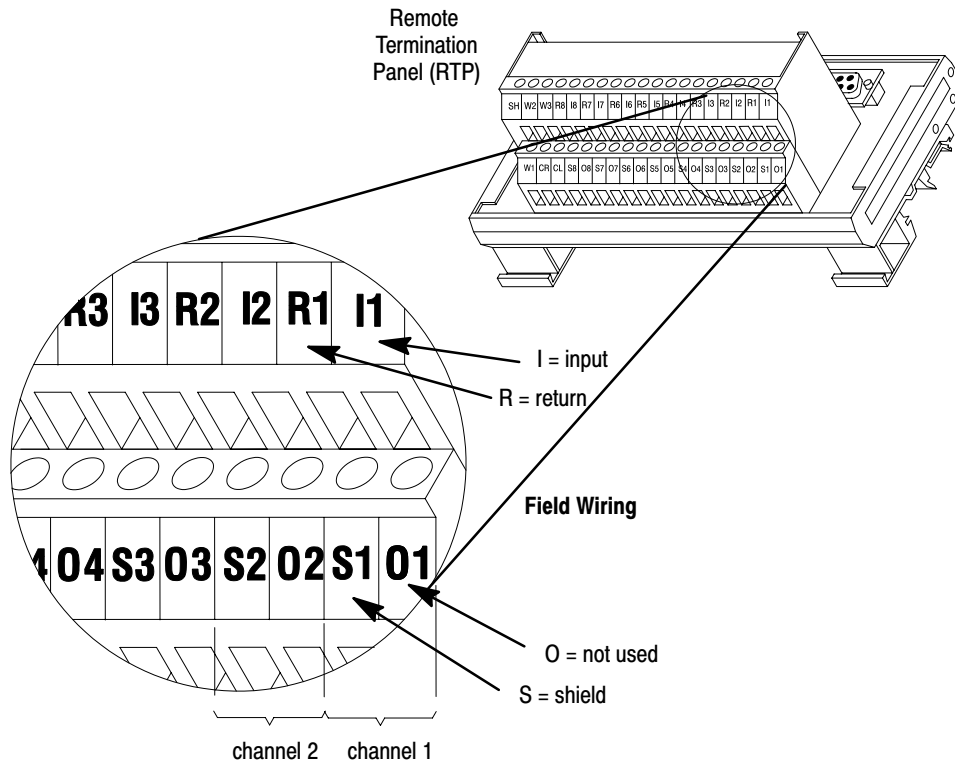

To connect thermocouple wiring (22-12 AWG) to the remote termination panel:

1. Strip 9 mm (3/8 inch) of insulation from the wire.
2. Insert the wire into the open connector slot.
3. Tighten the screw to clamp the wire.

Grounding the Shields

When using shielded cable or shielded thermocouple extension wire, ground the shield at only one end of the cable. Because we don't know whether you have the ability to provide a good ground at the other end, we recommend that you connect the shield drain wire to the "S" connection on the RTP for the particular channel. All shield connections are internally connected together in the RTP so that only one wire is required to ground the entire remote termination panel. Ground the RTP by connecting a wire from the "SH" connection on the RTP to a ground bus in the metal cabinet in which the remote termination panel is mounted.

If you **do not** want to ground a particular shield at the RTP, you can remove the jumper for that particular channel. This will allow the shield to float at the RTP end. To remove a jumper, you must cut it out. If you cut out a jumper, clip it as close to the circuit board as possible at both ends. **Once the jumper is removed it cannot be replaced.** The jumpers (Figure 2.6) are labeled J1 thru J8, corresponding to channels 1 thru 8 respectively.

Figure 2.6
Jumper Positions

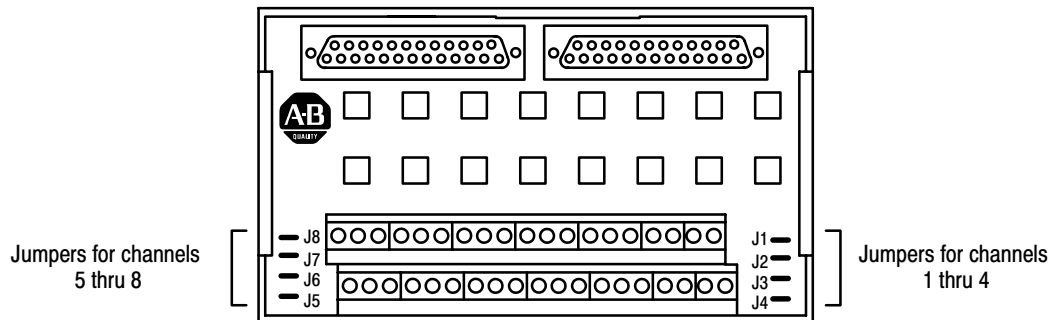

Interpreting the Indicator Lights

The front panel of the analog module contains two bi-color indicators: a red/green RUN/FLT (fault) indicator and a red/green CAL/COM indicator (Figure 2.7).

Figure 2.7
Diagnostic Indicators

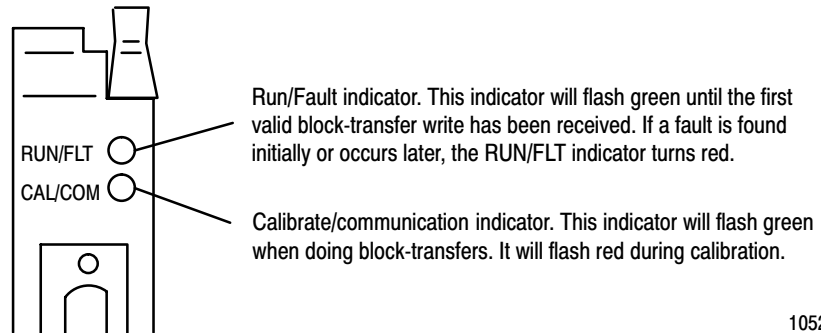

10528-I

At power-up, an initial module self-check occurs. When the check is completed satisfactorily, the RUN/FAULT indicator will start to flash green. It will continue to flash green until the first valid block-transfer write has been received. If a fault is found initially or occurs later, the RUN/FLT indicator turns red.

The bottom indicator is the calibrate/communication indicator. This indicator will flash green when doing block-transfers. It will flash red during calibration.

Possible module fault causes and corrective action are discussed in Chapter 9, "Troubleshooting."

What to do next

To learn how to use ladder logic to communicate with the temperature control module, read chapter 3.

Communicating With Your Module

Chapter Objectives

In this chapter, we describe

- I/O image
- communication sequence
- single-transfer programming
- block-transfer programming
- module update period

I/O Image

The temperature control module uses a word of input image table and a word of output image table.

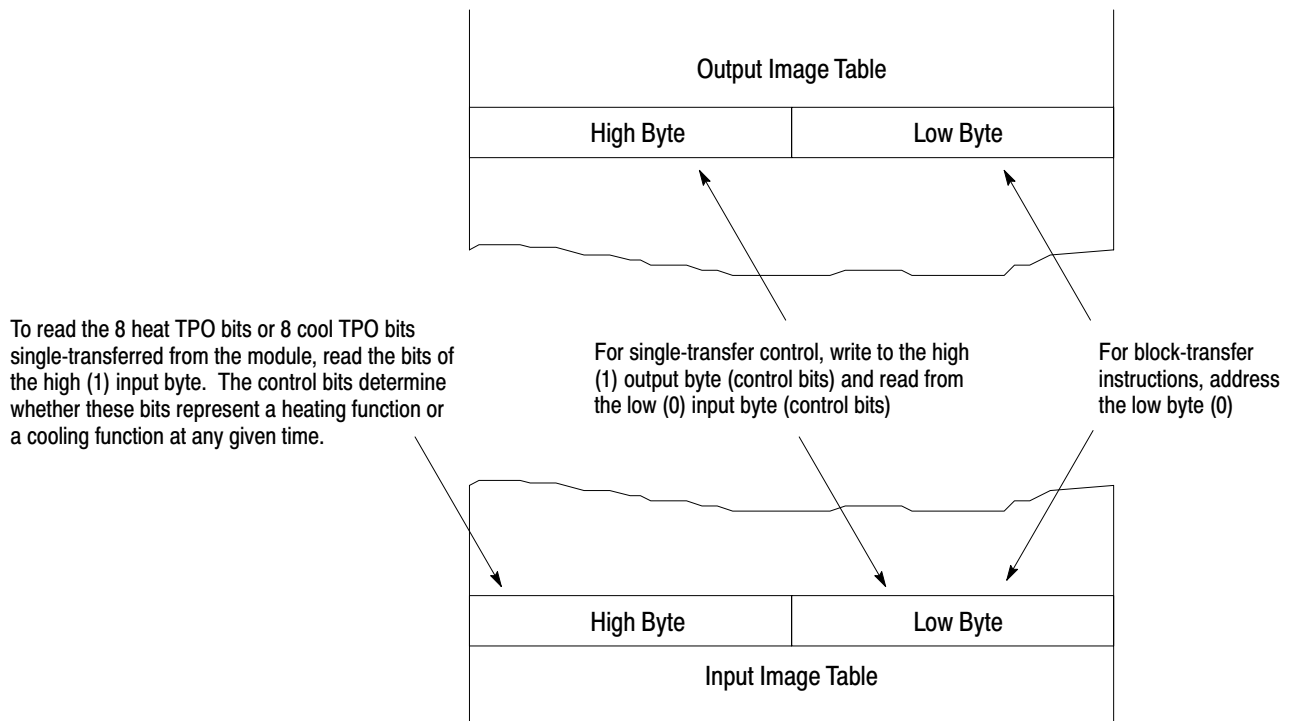

- The low byte of the output image word is used exclusively for block-transfer.
- The high byte of the output image word is used exclusively for single-transfer. You address these bits to control whether the single-transfer input is for a heating function or a cooling function.

- The low byte of the input image word is used both for single-transfer and block-transfer. For single-transfer, you read this byte to determine whether the high byte of the input image word contains heat bits or cool TPO bits.
- The high byte of the input image word is used exclusively for single-transfer. This byte contains the control-variable output of each loop as the duty cycle of a bit that is cycled at a regular period (TPO). You read the control bits in the low byte to determine whether these bits are for a heating function or a cooling function.

Communication Sequence

Your ladder logic must provide the proper sequence of block-transfer and single-transfer communication with the module.

At initial start-up

1. Write (block-transfer) the configuration block for each loop to the module
2. Write (block-transfer) the gains block to the module.
3. Write (block-transfer) the dynamic block to the module
4. Read (block-transfer) the system status block from the module

If you use the dynamic block to select auto-tuning, you then must

1. Read (block-transfer) the system status block from the module on a regular basis (using a timer to trigger block-transfers) to determine when the auto-tuning is complete
2. When auto-tuning is complete, write (block-transfer) the dynamic block to the module to remove the auto-tuning selection
3. When auto-tuning is complete, read (block-transfer) the gains block from the module to store a record of the gains derived from auto-tuning
4. Whenever there is no block-transfer in process for the temperature control module, pass the single-transferred TPO of each loop on to the output module driving the heating/cooling elements

After initial start-up and auto-tuning

1. Write (block-transfer) the dynamic block to the module whenever necessary to change mode

2. Read (block-transfer) the system status block from the module on a regular basis (using a timer to trigger block-transfers) to monitor the status of the PID loops. The module's period for updating this temperature data is approximately **one second**. The module's period for updating the TPO bits it makes available thru block-transfer is approximately **500ms**.
3. Whenever there is no block-transfer in process for the temperature control module, pass the single-transferred TPO of each loop on to the output module driving the heating/cooling elements

Single-Transfer Programming

Single-transfer of I/O data occurs automatically in each I/O scan. That is, a single unit of I/O data can be exchanged between each I/O module and its corresponding address in the I/O image table. The size of the unit of I/O data available for transfer to/from each I/O module is determined by the I/O addressing mode selected for the I/O chassis. The 1771-TCM module uses 16 bits of input image and 16 bits of output image. Therefore, the I/O chassis must be set for either 1-slot or 1/2-slot addressing.

Control Bits

The meaning of the control bits in the high byte of the output image word and the low byte of the input image word are as follows.

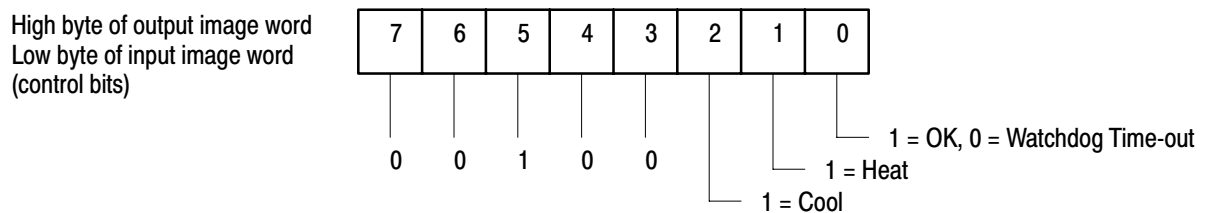

Your ladder logic must write to the high byte of the output image word of the 1771-TCM module to tell it whether to send the 8 heat bits or the 8 cool bits. Your ladder logic must then read the low byte of the input image word of the 1771-TCM module to determine whether it has sent the 8 heat bits or the 8 cool bits. Based on the value found in the low byte of the input image word, your ladder logic must move the high byte of the input image word of the 1771-TCM module to the output image byte of either the outputs controlling heating or the outputs controlling cooling.

In reading the low byte of the input image word, if your ladder logic detects bits 7, 6, and 0 to be off (watchdog time-out) it must turn off all heat and cool outputs. At that point you must cycle power (off then on) to the 1771-TCM module, and then reconfigure the module. If the watchdog timer bit stays off, replace the module.

TPO Bits

The loop designations of the heat/cool (control-variable) TPO bits in the high byte of the input image word are as follows.

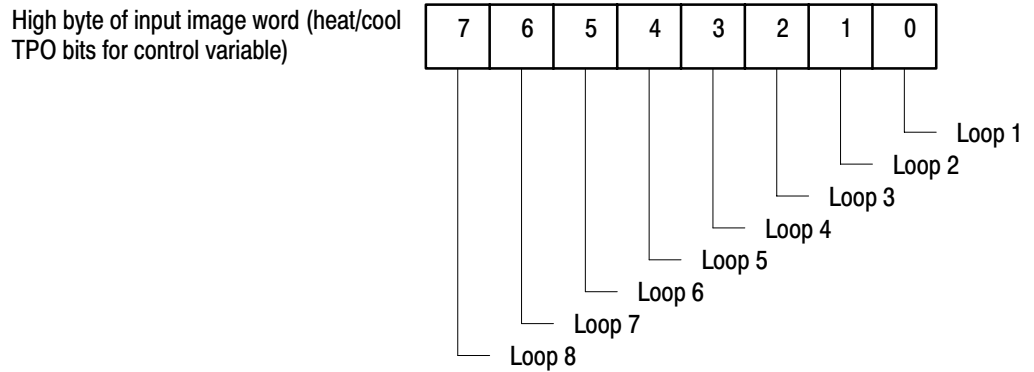

Controlling Heating Elements Only

In applications where the control variable TPO of each loop is used for only heating, the ladder logic for data single-transferred to/from the 1771-TCM module must do the following:

Write the decimal value 35 (binary 00100011) to the high byte of the output image word of the 1771-TCM module.



Read the low byte of the input image word of the 1771-TCM module.



If the low byte of the input image word of the 1771-TCM module has the value 35₁₀, move the value from the high byte of the input image word of the 1771-TCM module to the output image byte of the output module driving the heating elements.



If bit 0 (watchdog timer) of the low byte of the input image word of the 1771-TCM module **off**, zero the output image byte of the output module driving the heating elements.



If bit 0 (watchdog timer) of the low byte of the input image word of the 1771-TCM module **on** and the low byte of the input image word of the 1771-TCM module does not have the value 35₁₀, do not write to the output image byte of the outputs driving the heating elements.

The following figure shows an example of PLC-5® ladder logic to handle data single-transferred to/from the 1771-TCM module in an application where the control variable TPO of each loop is used for only heating.

This rung examines the low byte of TCM module's input image word to see if it is equal to 35₁₀. If true, it copies the high byte of the TCM module's input image word to the output image byte of the module driving the heating elements.

This rung unconditionally writes the value 35₁₀ to the high byte of the TCM module's input image word.

If the TCM module's watchdog timer bit is off, this rung zeros the output image byte of the outputs driving the heating elements.

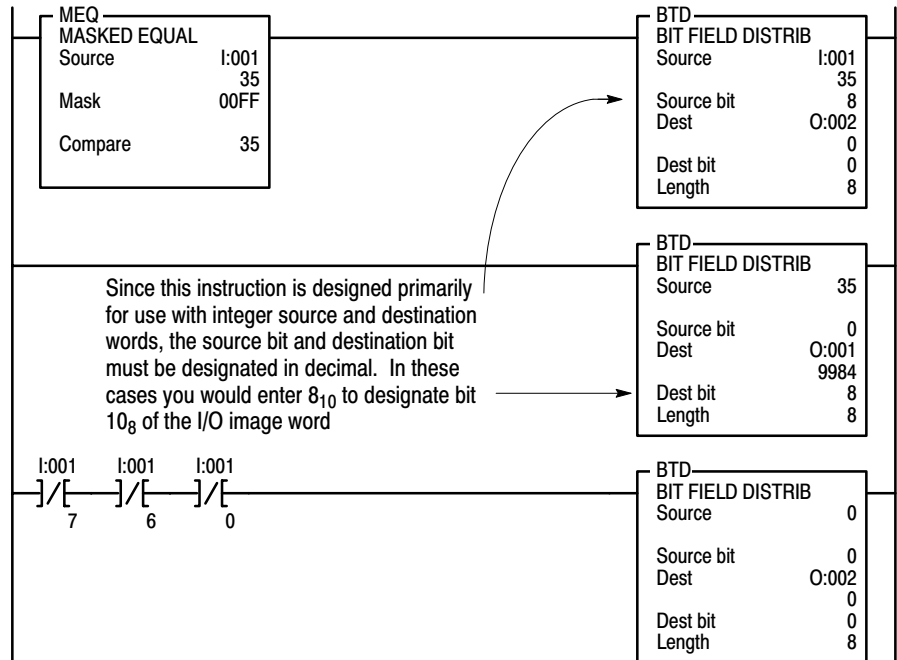





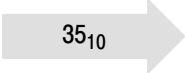

In this example:

- the 1771-TCM module and the output module driving the heating elements are in the same I/O chassis with the PLC-5 processor
- the chassis is set for 1-slot addressing
- the 1771-TCM module is in slot 1 (I/O group 1)
- the module driving the heating elements is in slot 2 (I/O group 2)

Controlling Heating and Cooling Elements

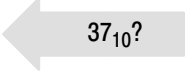
In applications where the control variable TPO of each loop is used for both heating and cooling, the ladder logic for data single-transferred to/from the 1771-TCM module must do the following:

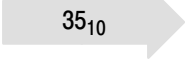
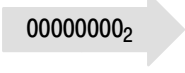
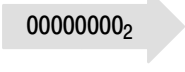
- | | | | |
|----------------|--|--|-----------------------------------|
| Step 1 | Write the decimal value 35 (binary 00100011) to the high byte of the output image word of the 1771-TCM module. |  | High byte of 1771-TCM output word |
| Step 2 | Read the low byte of the input image word of the 1771-TCM module. |  | Low byte of 1771-TCM input word |
| Step 3 | If the low byte of the input image word of the 1771-TCM module has the value 35 ₁₀ , move the value from the high byte of the input image word of the 1771-TCM module to the output image byte of the outputs driving the heating elements. |  | High byte of 1771-TCM input word |
| | |  | Heating-element outputs |
| Step 4 | Write the decimal value 37 (binary 00100101) to the high byte of the output image word of the 1771-TCM module. |  | High byte of 1771-TCM output word |
| Step 5 | Read the low byte of the input image word of the 1771-TCM module. |  | Low byte of 1771-TCM input word |
| Step 6 | If the low byte of the input image word of the 1771-TCM module has the value 37 ₁₀ , move the value from the high byte of the input image word of the 1771-TCM module to the output image byte of the outputs driving the cooling elements. |  | High byte of 1771-TCM input word |
| | |  | Cooling-element outputs |
| Step 7 | Write the decimal value 35 (binary 00100011) to the high byte of the output image word of the 1771-TCM module. |  | High byte of 1771-TCM output word |
| Step 8 | If bit 0 (watchdog timer) of the low byte of the input image word of the 1771-TCM module off , zero the output image byte of the outputs driving the heating elements and zero the output image byte of the outputs driving the cooling elements. |  | Heating-element outputs |
| | |  | Cooling-element outputs |
| Step 9 | If bit 0 (watchdog timer) of the low byte of the input image word of the 1771-TCM module on and the low byte of the input image word of the 1771-TCM module does not have the value 35 ₁₀ or 37 ₁₀ , do not write to the output image byte of the outputs driving the heating elements. | | |
| Step 10 | Loop back to step 2. | | |

The key to this logic is the switching between reading the heat bits and reading the cool bits from the same input image byte. The following figure shows an example of PLC-5 ladder logic to handle data single-transferred to/from the 1771-TCM module in an application where the control variable TPO of each loop is used for both heating and cooling.

This rung examines status bit S:1/15, which is on only during the first program scan, and input image I:004/7, which reflects the state of a pushbutton switch connected to that input. If either is on, it writes the value 35₁₀ to the high byte of the TCM module's input image word.

This rung examines the low byte of TCM module's input image word to see if it is equal to 35₁₀. If true, it copies the high byte of the TCM module's input image word to the output image byte of the module driving the heating elements, and writes the value 37₁₀ to the high byte of the TCM module's input image word.

If the TCM module's watchdog timer bit is off, this rung zeros the output image byte for the outputs driving the heating elements.

This rung examines the low byte of TCM module's input image word to see if it is equal to 37₁₀. If true, it copies the high byte of the TCM module's input image word to the output image byte of the module driving the heating elements, and writes the value 35₁₀ to the high byte of the TCM module's input image word.

If the TCM module's watchdog timer bit is off, this rung zeros the output image byte for the outputs driving the cooling elements.

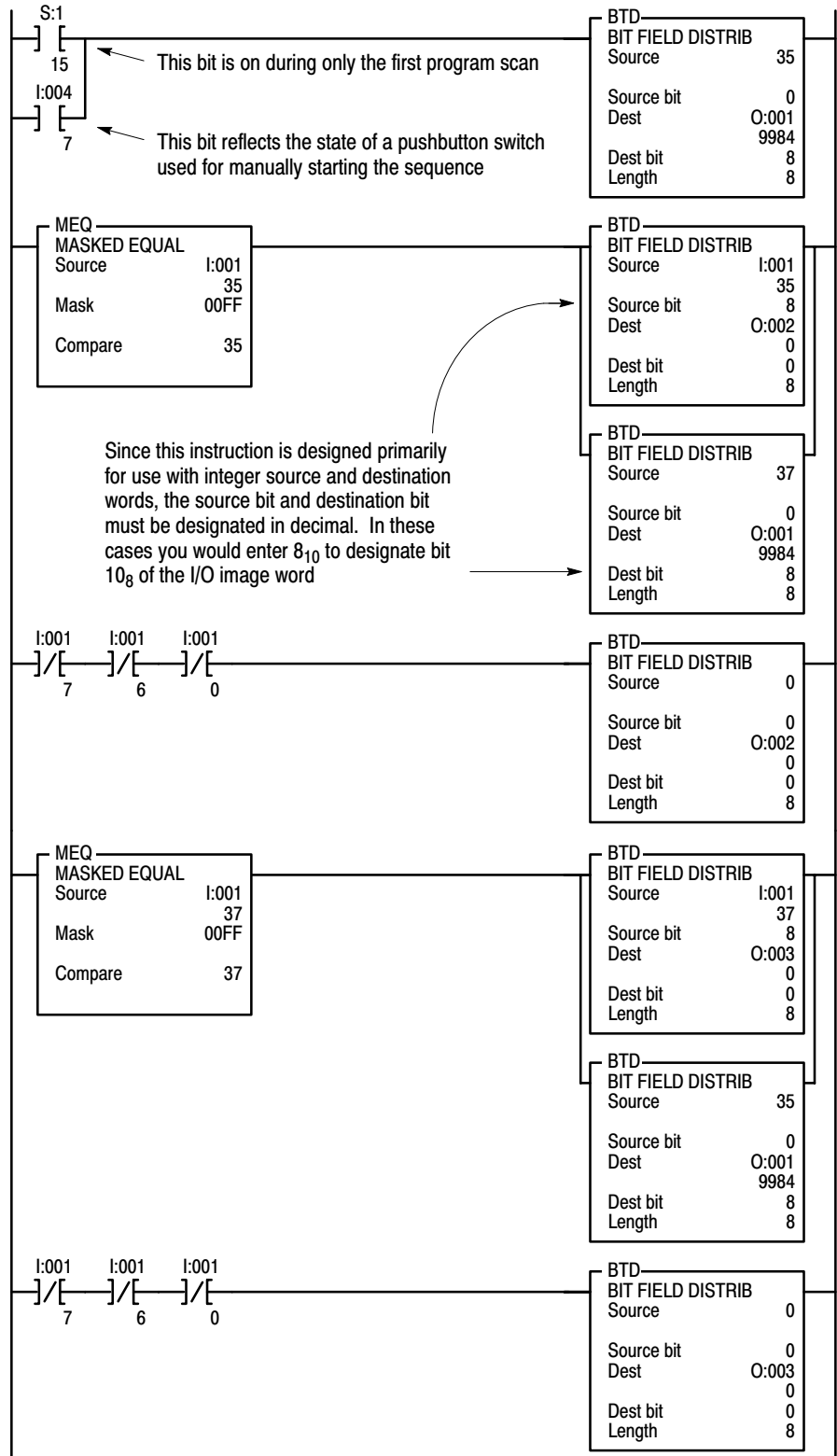

In this example:

- the 1771-TCM module the output modules driving the heating and cooling elements, and the input module providing the input for the manual-start pushbutton switch are in the same I/O chassis with the PLC-5 processor
- the chassis is set for 1-slot addressing
- the 1771-TCM module is in slot 1 (I/O group 1)
- the module driving the heating elements is in slot 2 (I/O group 2)
- the module driving the cooling elements is in slot 3 (I/O group 3)
- the module providing the input for the manual-start pushbutton switch is in slot 4 (I/O group 4)

Block Transfer Programming

To generate a block-transfer to the 1771-TCM module, your ladder logic must execute a block-transfer write instruction. To generate a block-transfer from the 1771-TCM module, your ladder logic must execute a block-transfer read instruction.

Enter the rack number and group number based on the module's physical location as with any other block-transfer module. The module entry specifies the byte (0 or 1) of the I/O image word. Although the module uses a full word of I/O image space, the low byte of the module's I/O image word is used for block-transfer. Therefore, in the block-transfer instruction, you must address the 1771-TCM module as module **0**.

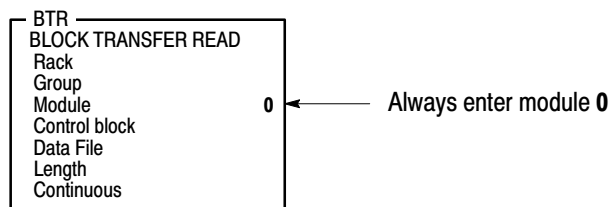

Your ladder logic will need to execute the block-transfer write instruction upon specific events to transfer the specific write blocks. Your ladder logic will need to execute the block-transfer read instruction on a regular basis at timed intervals. Since the module updates the read block data at a rate of only approximately once per second, executing the block-transfer read more often than that does not provide any benefit.

Block-Transfer Write

You can generate all block-transfer writes to your 1771-TCM module thru a single block-transfer write instruction. Enter the block length as **64** words. Write your ladder logic so that when you want to send a particular block of data to the 1771-TCM module, you first send it to the 64-word block addressed by the BTW instruction and then use the BTW instruction to send it to the module.

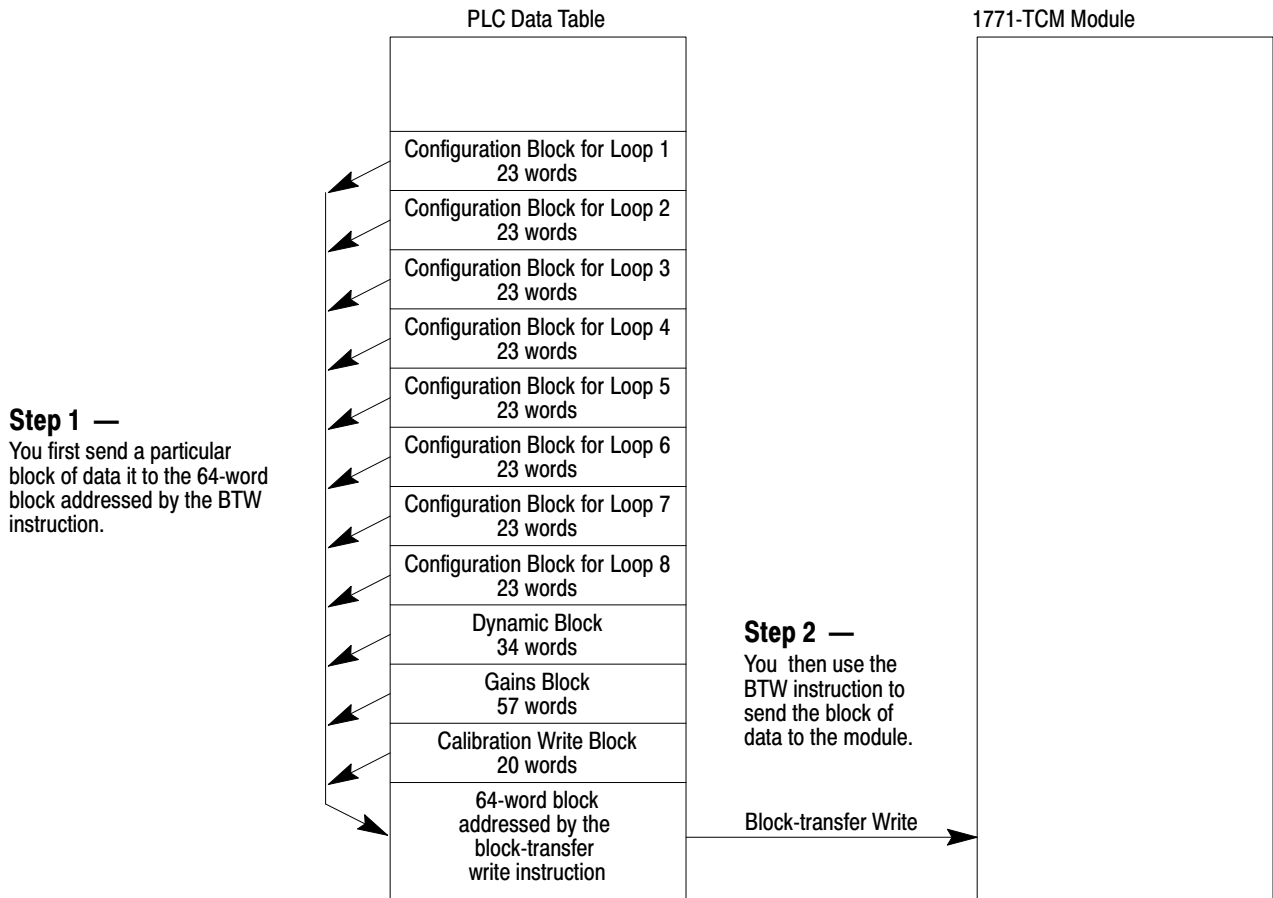

At the beginning of each block is a block identification code that you use to tell the module which block it is. The module automatically uses only the number of words appropriate for that particular type of block.

Block-Transfer Read

You can generate all block-transfer reads from your 1771-TCM module thru a single block-transfer read instruction. Enter the block length as **64** words. Write your ladder logic so that when you receive a block of data in the 64-word block addressed by the block-transfer read instruction, you first read the block identification code at the beginning of the block and then based on the ID, send the block of data to the appropriate address for that particular type of block

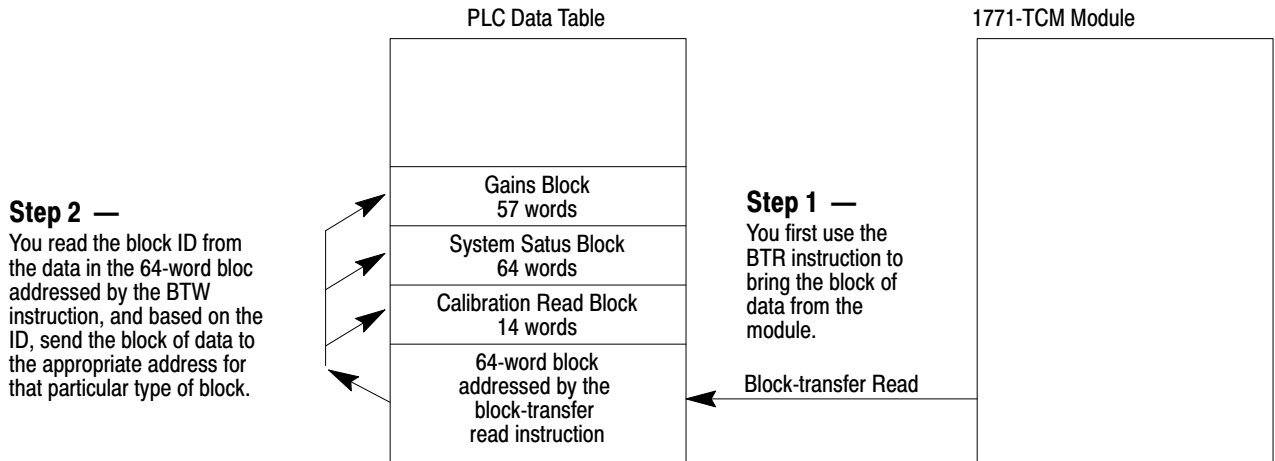

In the dynamic block that you send to the module, you specify whether the module should send back a gains block or a system status block in subsequent block-transfer reads.

Module Update Period

The temperature control module generally updates data for single-transfer on a shorter time period than it updates data for block-transfer.

- The module's period for updating the heat and cool TPO bits it makes available thru single-transfer is approximately **20ms**.
- The module's period for updating the heat and cool TPO bits it makes available thru block-transfer is approximately **500ms**.
- The module's period for updating the temperature values it makes available thru block-transfer is **1 second**.
- The module's period for updating the CV values it makes available thru block-transfer for heating is set by the heat maximum cycle time you enter in the configuration block (word 12).
- The module's period for updating the CV values it makes available thru block-transfer for cooling is set by the cool maximum cycle time you enter in the configuration block (word 14).

What to do next

To learn how to configure the temperature control module, read chapter 4.

Configuring the Module

Chapter Objectives

This chapter shows you how to independently configure each PID loop of the 1771-TCM module. This includes:

- block identification
- thermocouple break detection
- thermal runaway detection
- alarm dead band
- inferred decimal point
- the configuration block

Block Identification

The first word of each block contains a block identification code that you use to tell the module that it is a configuration block and that you use to tell the module which loop the block is to configure.

Thermocouple Break Detection

In the dynamic block (for loop 1, bit 1 of word 2) you can select to have a loop operate in automatic mode. However, if a thermocouple wire breaks, the loop would run away if left in automatic mode. Therefore, the module provides thermocouple break detection. With bits 1 and 2 of word 2 of the configuration block, you select a mode to which the loop is to switch when a thermocouple wire break is detected in automatic mode.

The selections are:

- disable the PID loop by forcing the CV value to zero
- set the output to the TC-break forced CV value (set in word 9)
- set the output to the manual-mode CV value

Thermal Runaway Detection

The values you enter into words 22 and 23 establish a maximum rate of change in the PV temperature input value that you will allow. The temperature change value you enter in word 22 divided by the period value you enter in word 23 is the thermal runaway rate. With bits 4 and 5 of word 2 of the configuration block, you select a mode to which the loop is to switch when it detects that the rate of change of the PV temperature has reached the thermal runaway rate. The selections are:

- disable the PID loop by forcing the CV value to zero
- set the output to the thermal runaway forced CV value (set in word 10)
- set the output to the manual-mode CV value

Alarm Dead Band

Once the temperature alarm bits are on, they are kept on until the temperature drops below the high alarm by the alarm dead-band value or rise above the low alarm by this value. This dead band provides a hysteresis effect. The dead-band value applies to all alarm values.

- **Low Alarm With Dead Band** — When the temperature falls below the user-defined low alarm value, the low alarm bit is turned on. When the temperature rises above the level of the low alarm value but still below the level of the dead-band value, the low alarm bit remains on. Only when the temperature rises above the dead-band level will the alarm bit be turned off.
- **High Alarm With Dead Band** — When the temperature rises above the user-defined high alarm value, the high alarm bit is turned on. When the temperature falls below the level of the high alarm value but still above the level of the dead-band value, the high alarm bit remains on. Only when the temperature falls below the dead-band level will the alarm bit be turned off.

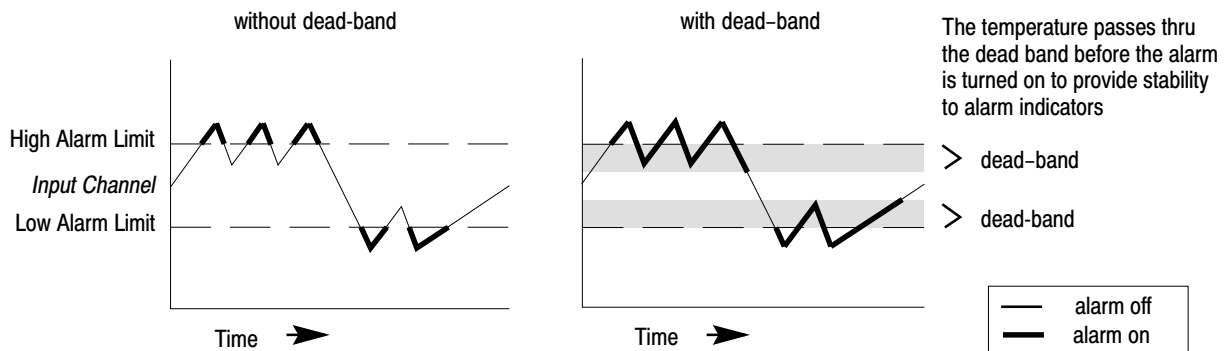

Inferred Decimal Point

For words 4 thru 20, you enter a 16-bit signed integer value. However, as you enter the value you must be aware of an inferred decimal point.

- For these values in words 4 and 7 thru 14, the inferred decimal point is **2** places from the right (causing the resolution to be **0.01**).
- For the temperature values in words 5, 6, and 17 thru 20, the inferred decimal point is **1** place from the right (causing the resolution to be **0.1**). Also, for each of these values, the range is dependant upon the type of thermocouple used. The range for each type of thermocouple is specified in appendix A.

Configuration Block

The configuration block contains 23 words as follows:

Word	Bits	Description																								
1	0–15	<p>Block Identification Code bit 15 bit 0</p> <ul style="list-style-type: none"> • 1000 1000 0000 0001 (8801₁₆) = loop 1 • 1000 1000 0000 0010 (8802₁₆) = loop 2 • 1000 1000 0000 0011 (8803₁₆) = loop 3 • 1000 1000 0000 0100 (8804₁₆) = loop 4 • 1000 1000 0000 0101 (8805₁₆) = loop 5 • 1000 1000 0000 0110 (8806₁₆) = loop 6 • 1000 1000 0000 0111 (8807₁₆) = loop 7 • 1000 1000 0000 1000 (8808₁₆) = loop 8 																								
2	0	Always = 0.																								
1–2		<p>TC Break Detection Configuration — When a TC break is detected (if auto mode had been selected in the dynamic block), the operating mode is switched to:</p> <p>bit 2 bit 1 selection</p> <ul style="list-style-type: none"> • 0 0 = Disable PID loop (CV = 0) • 0 1 = Set output to TC-break forced CV value (set in word 9). • 1 0 = Set output to manual-mode CV value. • 1 1 Do not use this selection. It will freeze the output at the current CV value. However, the CV value will have already moved to beyond a satisfactory value before the TC break is detected. 																								
3		Always = 0.																								
4–5		<p>Thermal Runaway Configuration — When a runaway condition is detected, the operating mode is set as:</p> <p>bit 5 bit 4 selection</p> <ul style="list-style-type: none"> • 0 0 = Disable PID loop (CV = 0) • 0 1 = Set output to thermal-runaway forced CV value (set in word 10). • 1 0 = Set output to manual-mode CV value. • 1 1 is not used (illegal value). 																								
6		Always = 0.																								
7–8		<p>Loop Operational Mode</p> <p>bit 8 bit 7 selection</p> <ul style="list-style-type: none"> • 0 0 = Monitor TC input to indicate temperature and alarms, but no PID control of CV value (CV value held at 0). • 0 1 = Perform PID control of loop. • 1 0 = Disable loop (no CV value, temperature or alarms). • 1 1 is not used (illegal value). 																								
9–11		Always = 000.																								
12–15		<p>Thermocouple Type</p> <table style="width: 100%; border-collapse: collapse;"> <thead> <tr> <th style="text-align: left;">bit 15 . . 12</th> <th style="text-align: left;">selection</th> <th style="text-align: left;">bit 15 . . 12</th> <th style="text-align: left;">selection</th> <th style="text-align: left;">bit 15 . . 12</th> <th style="text-align: left;">selection</th> </tr> </thead> <tbody> <tr> <td>• 0000</td> <td>= mV</td> <td>• 0011</td> <td>= J</td> <td>• 0110</td> <td>= S</td> </tr> <tr> <td>• 0001</td> <td>= B</td> <td>• 0100</td> <td>= K</td> <td>• 0111</td> <td>= T</td> </tr> <tr> <td>• 0010</td> <td>= E</td> <td>• 0101</td> <td>= R</td> <td></td> <td></td> </tr> </tbody> </table>	bit 15 . . 12	selection	bit 15 . . 12	selection	bit 15 . . 12	selection	• 0000	= mV	• 0011	= J	• 0110	= S	• 0001	= B	• 0100	= K	• 0111	= T	• 0010	= E	• 0101	= R		
bit 15 . . 12	selection	bit 15 . . 12	selection	bit 15 . . 12	selection																					
• 0000	= mV	• 0011	= J	• 0110	= S																					
• 0001	= B	• 0100	= K	• 0111	= T																					
• 0010	= E	• 0101	= R																							

Chapter 4
Configuring the Module

Word	Bits	Description
3	0	Always = 0.
	1	Control Action <ul style="list-style-type: none"> • 0 = Control action is — E = SP-PV • 1 = Control action is — E = PV-SP
	2-3	Always = 00.
	4	CV Ramping — Selects whether to use a fixed CV ramp rate (set in word 4) for PV to reach the set point. <ul style="list-style-type: none"> • 0 = Disable CV ramping. • 1 = Enable CV ramping.
	5-6	Cooling Method <u>bit 6</u> <u>bit 5</u> <u>selection</u> <ul style="list-style-type: none"> • 0 0 = No cooling. • 0 1 = Air cooling. • 1 0 = Oil cooling. • 1 1 = Water cooling.
	7	Alarm Enable <ul style="list-style-type: none"> • 0 = Suppress all alarms. • 1 = Report all alarm conditions.
	8-9	Auto-Tuning Gains — Selects gains to use during auto-tuning. <u>bit 9</u> <u>bit 8</u> <u>selection</u> <ul style="list-style-type: none"> • 0 0 = Low gains. • 0 1 = Medium gains. • 1 0 = High gains. • 1 1 = Not used (illegal value).
	10	Do/Don't Use Auto-Tuning Gains — Selects gains to use after auto-tuning. <ul style="list-style-type: none"> • 0 = Use the gains derived from auto-tuning. • 1 = Use the gains block-transferred to the module before auto-tuning.
	11-15	Always = 0 0000.
4	0-15	CV Ramp Rate — If enabled by bit 4 of word 2, the maximum rate (degrees/minute) at which the CV is allowed to increase as the PV reaches the set-point. (0.00 thru 99.99)
5	0-15	Maximum PV in Engineering Units — (0 thru 999.9°)
6	0-15	Minimum PV in Engineering Units — (0 thru 999.9°)
7	0-15	High CV Limit — The maximum CV percentage allowable. (-100.00 thru +100.00)
8	0-15	Low CV Limit — The minimum CV percentage allowable. (-100.00 thru +100.00)
9	0-15	Forced CV Value on TC Break — The percentage value forced into the CV when a broken TC is detected. (-100.00 thru +100.00)
10	0-15	Forced CV Value on Thermal Run-away — The percentage value forced into the CV when thermal run-away is detected. (-100.00 thru +100.00)
11	0-15	Heat Minimum Cycle Time — The minimum cycle time in seconds for which the heat bit is on. (0.00 thru 100.00)
12	0-15	Heat Maximum Cycle Time — The maximum cycle time in seconds for which the heat bit is on. (0.00 thru 100.00)

Word	Bits	Description
13	0-15	Cool Minimum Cycle Time — The minimum cycle time in seconds for which the cool bit is on. (0.00 thru 100.00)
14	0-15	Cool Maximum Cycle Time — The maximum cycle time in seconds for which the cool bit is on. (0.00 thru 100.00)
15	0-15	Always = 0.
16	0-15	Always = 0.
17	0-15	Low Temperature Alarm Value — A PV value at the low end of the sensor limit, but still above the minimum PV value (0 thru 999.9°)
18	0-15	High Temperature Alarm Value — A PV value at the high end of the sensor limit, but still below the max PV value (0 thru 999.9°)
19	0-15	Low Deviation Alarm Value — An error value that specifies the greatest deviation below the set point that the process can tolerate. (0 thru 999.9°)
20	0-15	High Deviation Alarm Value — An error value that specifies the greatest deviation above the set point that the process can tolerate. (0 thru 999.9)
21	0-15	Temperature Alarm Dead Band — Once the temperature alarm bits are on, they are kept on until the temperature drops below the high alarm by this value or rise above the low alarm by this value. The dead-band value applies to all alarm values. (0 thru 100°)
22	0-15	Thermal Runaway Temperature Change Value — This temperature-change value divided by the period is the thermal runaway rate. (0 thru 100°)
23	0-15	Thermal Runaway Period in Minutes — The temperature-change value divided by this period is the thermal runaway rate. (0 thru 100)

- Words 1 thru 23 of the loop-1 configuration block are identified by the mnemonics L1C01 thru L1C23 in ProSet 700 software.
- Words 1 thru 23 of the loop-2 configuration block are identified by the mnemonics L2C01 thru L2C23 in ProSet 700 software.
- Words 1 thru 23 of the loop-3 configuration block are identified by the mnemonics L3C01 thru L3C23 in ProSet 700 software.
- Words 1 thru 23 of the loop-4 configuration block are identified by the mnemonics L4C01 thru L4C23 in ProSet 700 software.
- Words 1 thru 23 of the loop-5 configuration block are identified by the mnemonics L5C01 thru L5C23 in ProSet 700 software.
- Words 1 thru 23 of the loop-6 configuration block are identified by the mnemonics L6C01 thru L6C23 in ProSet 700 software.
- Words 1 thru 23 of the loop-7 configuration block are identified by the mnemonisc L7C01 thru L7C23 in ProSet 700 software.
- Words 1 thru 23 of the loop-8 configuration block are identified by the mnemonisc L8C01 thru L8C23 in ProSet 700 software.

What to do next

To learn how to set gains for the PID loops of the temperature control module, read chapter 5.

Setting Gains

Chapter Objectives

This chapter shows you how to independently set the gains for each PID loop of the 1771-TCM module. This includes:

- sequence of block-transfers
- auto-tuning the loops
- fine tuning the loops
- block identification
- inferred decimal point
- the configuration block

Sequence of Block-Transfers

At initial start-up, you must write (block-transfer) the gains block to the 1771-TCM module. If you select auto-tuning, for any loop that is successfully tuned, the gains for that loop in any gains block you had sent to the module before hand will be ignored. Once auto-tuning is complete, you must read (block-transfer) the gains block from the module to store it in PLC processor memory. The module's memory is volatile. Whenever power to the module is interrupted, you must again send the gains block to it.

If auto-tuning is not successful for any loops (as indicated in the status block) the gains you had sent for those loops before auto-tuning will be used by the module.

Auto-tuning the Loops

You select auto-tuning from the dynamic block. For each loop, you must turn on a specific bit to enable auto-tuning for that corresponding loop. To trigger the start of auto-tuning, you must also turn on a bit that applies to all loops.

Important: Do not start auto-tuning for a loop unless its PV input is at the ambient temperature. If not, the auto-tuning may not provide suitable gains for the application.

The auto-tuning algorithm will not work correctly if the system lag time is less than 100 seconds. In that case, the auto-tuning will calculate large gain values, which will probably cause the PV to overshoot the set point.

Fine-tuning the Loops

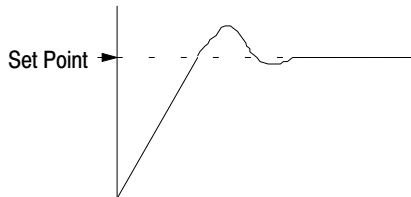

After auto-tuning, you may want to fine-tune the loops. As you fine-tune a loop, first try adjusting the proportional gain; this will have the greatest impact. Your second choice for adjustment should be the integral gain. The derivative gain should be the last choice for fine-tuning a loop.

If the loop has a problem **over-shooting** the set point, you may be able to improve the loop response by doing one or more of the following (in order of effectiveness):

1. decrease the proportional gain
2. decrease the integral gain
3. increase the derivative gain

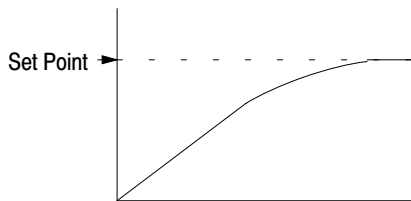

If the loop is **slow** in reaching the set point, you may be able to improve the loop response by doing one or more of the following (in order of effectiveness):

1. increase the proportional gain
2. increase the integral gain
3. decrease the derivative gain

Block Identification

The first word of each gains block contains a block identification code (10 1000 1000 0000 1001 or 8809₁₆) that you use to tell the module that it is a gains block.

Inferred Decimal Point

For each gain value, you enter a 16-bit integer value. However, as you enter each gain value you must be aware of an inferred decimal point.

- For each **proportional** gain, the inferred decimal point is **2** places from the right (causing the resolution to be **0.01**).
- For each **integral** gain, the inferred decimal point is **4** places from the right (causing the resolution to be **0.0001**).
- For each **derivative** gain, the inferred decimal point is **1** place from the right (causing the resolution to be **0.1**).

Gains Block

The gains block contains 57 words as follows:

Word	Bits	Description
1	0-15	Block Identification Code — 1000 1000 0000 1001 (8809 ₁₆)
2	0-15	Loop-1 Heat Proportional Gain — (0.00 thru 327.67)
3	0-15	Loop-1 Heat Integral Gain — (0.000 thru 3.2767)
4	0-15	Loop-1 Heat Derivative Gain — (0.0 thru 3276.7)
5	0-15	Loop-1 Cool Proportional Gain — (0.00 thru 327.67)
6	0-15	Loop-1 Cool Integral Gain — (0.000 thru 3.2767)
7	0-15	Loop-1 Cool Derivative Gain — (0.0 thru 3276.7)
8	0-15	Loop-1 Integral Gain Multiplier — (0 or 1 = x1 — 10 = x10 — 100 = x100)
9	0-15	Loop-2 Heat Proportional Gain — (0.00 thru 327.67)
10	0-15	Loop-2 Heat Integral Gain — (0.000 thru 3.2767)
11	0-15	Loop-2 Heat Derivative Gain — (0.0 thru 3276.7)
12	0-15	Loop-2 Cool Proportional Gain — (0.00 thru 327.67)
13	0-15	Loop-2 Cool Integral Gain — (0.000 thru 3.2767)
14	0-15	Loop-2 Cool Derivative Gain — (0.0 thru 3276.7)
15	0-15	Loop-2 Integral Gain Multiplier — (0 or 1 = x1 — 10 = x10 — 100 = x100)
16	0-15	Loop-3 Heat Proportional Gain — (0.00 thru 327.67)
17	0-15	Loop-3 Heat Integral Gain — (0.000 thru 3.2767)
18	0-15	Loop-3 Heat Derivative Gain — (0.0 thru 3276.7)
19	0-15	Loop-3 Cool Proportional Gain — (0.00 thru 327.67)
20	0-15	Loop-3 Cool Integral Gain — (0.000 thru 3.2767)
21	0-15	Loop-3 Cool Derivative Gain — (0.0 thru 3276.7)
22	0-15	Loop-3 Integral Gain Multiplier — (0 or 1 = x1 — 10 = x10 — 100 = x100)

Chapter 5
Setting Gains

Word	Bits	Description
23	0-15	Loop-4 Heat Proportional Gain — (0.00 thru 327.67)
24	0-15	Loop-4 Heat Integral Gain — (0.000 thru 3.2767)
25	0-15	Loop-4 Heat Derivative Gain — (0.0 thru 3276.7)
26	0-15	Loop-4 Cool Proportional Gain — (0.00 thru 327.67)
27	0-15	Loop-4 Cool Integral Gain — (0.000 thru 3.2767)
28	0-15	Loop-4 Cool Derivative Gain — (0.0 thru 3276.7)
29	0-15	Loop-4 Integral Gain Multiplier — (0 or 1 = x1 — 10 = x10 — 100 = x100)
30	0-15	Loop-5 Heat Proportional Gain — (0.00 thru 327.67)
31	0-15	Loop-5 Heat Integral Gain — (0.000 thru 3.2767)
32	0-15	Loop-5 Heat Derivative Gain — (0.0 thru 3276.7)
33	0-15	Loop-5 Cool Proportional Gain — (0.00 thru 327.67)
34	0-15	Loop-5 Cool Integral Gain — (0.000 thru 3.2767)
35	0-15	Loop-5 Cool Derivative Gain — (0.0 thru 3276.7)
36	0-15	Loop-5 Integral Gain Multiplier — (0 or 1 = x1 — 10 = x10 — 100 = x100)
37	0-15	Loop-6 Heat Proportional Gain — (0.00 thru 327.67)
38	0-15	Loop-6 Heat Integral Gain — (0.000 thru 3.2767)
39	0-15	Loop-6 Heat Derivative Gain — (0.0 thru 3276.7)
40	0-15	Loop-6 Cool Proportional Gain — (0.00 thru 327.67)
41	0-15	Loop-6 Cool Integral Gain — (0.000 thru 3.2767)
42	0-15	Loop-6 Cool Derivative Gain — (0.0 thru 3276.7)
43	0-15	Loop-6 Integral Gain Multiplier — (0 or 1 = x1 — 10 = x10 — 100 = x100)
44	0-15	Loop-7 Heat Proportional Gain — (0.00 thru 327.67)
45	0-15	Loop-7 Heat Integral Gain — (0.000 thru 3.2767)
46	0-15	Loop-7 Heat Derivative Gain — (0.0 thru 3276.7)
47	0-15	Loop-7 Cool Proportional Gain — (0.00 thru 327.67)
48	0-15	Loop-7 Cool Integral Gain — (0.000 thru 3.2767)
49	0-15	Loop-7 Cool Derivative Gain — (0.0 thru 3276.7)
50	0-15	Loop-7 Integral Gain Multiplier — (0 or 1 = x1 — 10 = x10 — 100 = x100)

Word	Bits	Description
51	0-15	Loop-8 Heat Proportional Gain — (0.00 thru 327.67)
52	0-15	Loop-8 Heat Integral Gain — (0.000 thru 3.2767)
53	0-15	Loop-8 Heat Derivative Gain — (0.0 thru 3276.7)
54	0-15	Loop-8 Cool Proportional Gain — (0.00 thru 327.67)
55	0-15	Loop-8 Cool Integral Gain — (0.000 thru 3.2767)
56	0-15	Loop-8 Cool Derivative Gain — (0.0 thru 3276.7)
57	0-15	Loop-8 Integral Gain Multiplier — (0 or 1 = x1 — 10 = x10 — 100 = x100)

- Words 1 thru 57 of the gains command (write) block are identified by the mnemonics TGC01 thru TGC57 in ProSet 700 software.
- Words 1 thru 57 of the gains status (read) block are identified by the mnemonics TGS01 thru TGS57 in ProSet 700 software.

What to do next

To learn how to control the dynamic block of the temperature control module, read chapter 6.

Operating the Module

Chapter Objectives

This chapter shows you how to control the dynamic block that you send to the 1771-TCM module to control operation of the loops. This includes.

- sequence of block-transfers
- block identification
- inferred decimal point
- the dynamic block

Sequence of Block-transfers

At initial start-up, you must write (block-transfer) the dynamic block to the 1771-TCM module to establish its mode of operation. After that, you must send a dynamic block to the module any time you want to change its operating mode.

Thru the dynamic block you also control the module's response to the execution of a block-transfer read instruction. The module can send either a gains block or a system status block in response to a block-transfer read execution. Whenever you want the module to switch from sending the system status block to sending the gains block or switch from sending the gains block to sending the system status block, you must send a dynamic block to establish that mode of response to block-transfer reads.

Block Identification

The first word of each dynamic block contains a block identification code (1000 1000 0000 1010 or $880A_{16}$) that you use to tell the module that it is a dynamic block.

Inferred Decimal Point

For the manual output value (CV), the run temperature set-point value, and the standby temperature set-point value, you enter a 16-bit signed integer value. However, as you enter the value you must be aware of an inferred decimal point.

- For the manual output value (CV), the inferred decimal point is **2** places from the right (causing the resolution to be **0.01**).
- For the run temperature set-point value, and the standby temperature set-point value, the inferred decimal point is **1** place from the right (causing the resolution to be **0.1**).

Dynamic Block

The dynamic block contains 34 words as follows:

- Words 1 thru 34 of the dynamic block are identified by the mnemonics TDC01 thru TDC34 in ProSet 700 software.

Word	Bits	Description
1	0-15	Block Identification Code — 1000 1000 0000 1010 (880A ₁₆)
2	0	Loop-1 Enable <ul style="list-style-type: none"> 0 = Loop 1 disabled. 1 = Loop 1 enabled if PID control mode selected (bits 7-8, word 2, config block).
	1	Loop-1 Auto/Manual Mode Select <ul style="list-style-type: none"> 0 = Loop 1 is in the manual mode — the manual output value (from word 5) is used as the CV value. 1 = Loop 1 is in the automatic mode — the PID algorithm generates the CV value.
	2	Loop-1 Set-Point Select <ul style="list-style-type: none"> 0 = Select the standby-temperature set-point value from word 3. 1 = Select the run-temperature set-point value from word 4.
	3	Loop-1 Auto-Tuning Enable <ul style="list-style-type: none"> 0 = Disable auto-tuning. 1 = Enable auto-tuning — auto-tuning can be invoked by an off-to-on transition of bit 1 of word 34.
	4	Always = 0.
	5	Loop-1 PID Integral Term Reset Enable <ul style="list-style-type: none"> 0 = Accumulate PID integral term. 1 = Reset the PID integral term on the 0-to-1 transition, and then allow accumulation until the next 0-to-1 transition.
	6-15	Not used.
3	0-15	Loop-1 Standby Temperature Set-point Value — Used when bit 2 of word 2 is off (0 thru 999.9°).
4	0-15	Loop-1 Run Temperature Set-point Value — Used when bit 2 of word 2 is on (0 thru 999.9°).
5	0-15	Loop-1 Manual Output Value (CV) — Used when bit 1 of word 2 is off (-100.00 thru +100.00).

Word	Bits	Description
6	0	Loop-2 Enable <ul style="list-style-type: none"> • 0 = Loop 2 disabled. • 1 = Loop 2 enabled if PID control mode selected (bits 7–8, word 2, config block).
	1	Loop-2 Auto/Manual Mode Select <ul style="list-style-type: none"> • 0 = Loop 2 is in the manual mode — the manual output value (from word 9) is used as the CV value. • 1 = Loop 2 is in the automatic mode — the PID algorithm generates the CV value.
	2	Loop-2 Set-Point Select <ul style="list-style-type: none"> • 0 = Select the standby-temperature set-point value from word 7. • 1 = Select the run-temperature set-point value from word 8.
	3	Loop-2 Auto-Tuning Enable <ul style="list-style-type: none"> • 0 = Disable auto-tuning. • 1 = Enable auto-tuning — auto-tuning can be invoked by an off-to-on transition of bit 1 of word 34.
	4	Always = 0.
	5	Loop-2 PID Integral Term Reset Enable <ul style="list-style-type: none"> • 0 = Accumulate PID integral term. • 1 = Reset the PID integral term on the 0-to-1 transition, and then allow accumulation until the next 0-to-1 transition.
	6–15	Always = 0.
7	0–15	Loop-2 Standby Temperature Set-point Value — Used when bit 2 of word 6 is off (0 thru 999.9°).
8	0–15	Loop-2 Run Temperature Set-point Value — Used when bit 2 of word 6 is on (0 thru 999.9°).
9	0–15	Loop-2 Manual Output Value (CV) — Used when bit 1 of word 6 is off (–100.00 thru +100.00).
10	0	Loop-3 Enable <ul style="list-style-type: none"> • 0 = Loop 3 disabled. • 1 = Loop 2 enabled if PID control mode selected (bits 7–8, word 2, config block).
	1	Loop-3 Auto/Manual Mode Select <ul style="list-style-type: none"> • 0 = Loop 3 is in the manual mode — the manual output value (from word 13) is used as the CV value. • 1 = Loop 3 is in the automatic mode — the PID algorithm generates the CV value.
	2	Loop-3 Set-Point Select <ul style="list-style-type: none"> • 0 = Select the standby-temperature set-point value from word 11. • 1 = Select the run-temperature set-point value from word 12.
	3	Loop-3 Auto-Tuning Enable <ul style="list-style-type: none"> • 0 = Disable auto-tuning. • 1 = Enable auto-tuning — auto-tuning can be invoked by an off-to-on transition of bit 1 of word 34.
	4	Always = 0.
	5	Loop-3 PID Integral Term Reset Enable <ul style="list-style-type: none"> • 0 = Accumulate PID integral term. • 1 = Reset the PID integral term on the 0-to-1 transition, and then allow accumulation until the next 0-to-1 transition.
	6–15	Always = 0.
11	0–15	Loop-3 Standby Temperature Set-point Value — Used when bit 2 of word 10 is off (0 thru 999.9°).

Word	Bits	Description
12	0-15	Loop-3 Run Temperature Set-point Value — Used when bit 2 of word 1 is on (0 thru 999.9°).
13	0-15	Loop-3 Manual Output Value (CV) — Used when bit 1 of word 10 is off (-100.00 thru +100.00).
14	0	Loop-4 Enable <ul style="list-style-type: none"> • 0 = Loop 4 disabled. • 1 = Loop 4 enabled if PID control mode selected (bits 7-8, word 2, config block).
	1	Loop-4 Auto/Manual Mode Select <ul style="list-style-type: none"> • 0 = Loop 4 is in the manual mode — the manual output value (from word 17) is used as the CV value. • 1 = Loop 4 is in the automatic mode — the PID algorithm generates the CV value.
	2	Loop-4 Set-Point Select <ul style="list-style-type: none"> • 0 = Select the standby-temperature set-point value from word 15. • 1 = Select the run-temperature set-point value from word 16.
	3	Loop-4 Auto-Tuning Enable <ul style="list-style-type: none"> • 0 = Disable auto-tuning. • 1 = Enable auto-tuning — auto-tuning can be invoked by an off-to-on transition of bit 1 of word 34.
	4	Always = 0.
	5	Loop-4 PID Integral Term Reset Enable <ul style="list-style-type: none"> • 0 = Accumulate PID integral term. • 1 = Reset the PID integral term on the 0-to-1 transition, and then allow accumulation until the next 0-to-1 transition.
	6-15	Always = 0.
15	0-15	Loop-4 Standby Temperature Set-point Value — Used when bit 2 of word 14 is off (0 thru 999.9°).
16	0-15	Loop-4 Run Temperature Set-point Value — Used when bit 2 of word 14 is on (0 thru 999.9°).
17	0-15	Loop-4 Manual Output Value (CV) — Used when bit 1 of word 14 is off (-100.00 thru +100.00).

Word	Bits	Description
18	0	Loop-5 Enable <ul style="list-style-type: none"> 0 = Loop 5 disabled. 1 = Loop 5 enabled if PID control mode selected (bits 7–8, word 2, config block).
	1	Loop-5 Auto/Manual Mode Select <ul style="list-style-type: none"> 0 = Loop 5 is in the manual mode — the manual output value (from word 21) is used as the CV value. 1 = Loop 5 is in the automatic mode — the PID algorithm generates the CV value.
	2	Loop-5 Set-Point Select <ul style="list-style-type: none"> 0 = Select the standby-temperature set-point value from word 19. 1 = Select the run-temperature set-point value from word 20.
	3	Loop-5 Auto-Tuning Enable <ul style="list-style-type: none"> 0 = Disable auto-tuning. 1 = Enable auto-tuning — auto-tuning can be invoked by an off-to-on transition of bit 1 of word 34.
	4	Always = 0.
	5	Loop -5 PID Integral Term Reset Enable <ul style="list-style-type: none"> 0 = Accumulate PID integral term. 1 = Reset the PID integral term on the 0-to-1 transition, and then allow accumulation until the next 0-to-1 transition.
	6–15	Always = 0.
19	0–15	Loop-5 Standby Temperature Set-point Value — Used when bit 2 of word 18 is off (0 thru 999.9°).
20	0–15	Loop-5 Run Temperature Set-point Value — Used when bit 2 of word 18 is on (0 thru 999.9°).
21	0–15	Loop-5 Manual Output Value (CV) — Used when bit 1 of word 18 is off (–100.00 thru +100.00).
22	0	Loop-6 Enable <ul style="list-style-type: none"> 0 = Loop 6 disabled. 1 = Loop 6 enabled if PID control mode selected (bits 7–8, word 2, config block).
	1	Loop-6 Auto/Manual Mode Select <ul style="list-style-type: none"> 0 = Loop 6 is in the manual mode — the manual output value (from word 25) is used as the CV value. 1 = Loop 6 is in the automatic mode — the PID algorithm generates the CV value.
	2	Loop-6 Set-Point Select <ul style="list-style-type: none"> 0 = Select the standby-temperature set-point value from word 23. 1 = Select the run-temperature set-point value from word 24.
	3	Loop-6 Auto-Tuning Enable <ul style="list-style-type: none"> 0 = Disable auto-tuning. 1 = Enable auto-tuning — auto-tuning can be invoked by an off-to-on transition of bit 1 of word 34.
	4	Always = 0.
	5	Loop 6 PID Integral Term Reset Enable <ul style="list-style-type: none"> 0 = Accumulate PID integral term. 1 = Reset the PID integral term on the 0-to-1 transition, and then allow accumulation until the next 0-to-1 transition.
	6–15	Always = 0.
23	0–15	Loop-6 Standby Temperature Set-point Value — Used when bit 2 of word 22 is off (0 thru 999.9°).

Word	Bits	Description
24	0-15	Loop-6 Run Temperature Set-point Value — Used when bit 2 of word 2 is on (0 thru 999.9°).
25	0-15	Loop-6 Manual Output Value (CV) — Used when bit 1 of word 22 is off (-100.00 thru +100.00).
26	0	Loop-7 Enable <ul style="list-style-type: none"> • 0 = Loop 7 disabled. • 1 = Loop 7 enabled if PID control mode selected (bits 7-8, word 2, config block).
	1	Loop-7 Auto/Manual Mode Select <ul style="list-style-type: none"> • 0 = Loop 7 is in the manual mode — the manual output value (from word 29) is used as the CV value. • 1 = Loop 7 is in the automatic mode — the PID algorithm generates the CV value.
	2	Loop-7 Set-Point Select <ul style="list-style-type: none"> • 0 = Select the standby-temperature set-point value from word 27. • 1 = Select the run-temperature set-point value from word 28.
	3	Loop-7 Auto-Tuning Enable <ul style="list-style-type: none"> • 0 = Disable auto-tuning. • 1 = Enable auto-tuning — auto-tuning can be invoked by an off-to-on transition of bit 1 of word 34.
	4	Always = 0.
	5	Loop-7 PID Integral Term Reset Enable <ul style="list-style-type: none"> • 0 = Accumulate PID integral term. • 1 = Reset the PID integral term on the 0-to-1 transition, and then allow accumulation until the next 0-to-1 transition.
	6-15	Always = 0.
27	0-15	Loop-7 Standby Temperature Set-point Value — Used when bit 2 of word 26 is off (0 thru 999.9°).
28	0-15	Loop-7 Run Temperature Set-point Value — Used when bit 2 of word 26 is on (0 thru 999.9°).
29	0-15	Loop-7 Manual Output Value (CV) — Used when bit 1 of word 26 is off (-100.00 thru +100.00).

Word	Bits	Description
30	0	Loop-8 Enable <ul style="list-style-type: none"> 0 = Loop 8 disabled. 1 = Loop 8 enabled if PID control mode selected (bits 7–8, word 2, config block).
	1	Loop-8 Auto/Manual Mode Select <ul style="list-style-type: none"> 0 = Loop 8 is in the manual mode — the manual output value (from word 33) is used as the CV value. 1 = Loop 8 is in the automatic mode — the PID algorithm generates the CV value.
	2	Loop-8 Set-Point Select <ul style="list-style-type: none"> 0 = Select the standby-temperature set-point value from word 31. 1 = Select the run-temperature set-point value from word 32.
	3	Loop-8 Auto-Tuning Enable <ul style="list-style-type: none"> 0 = Disable auto-tuning. 1 = Enable auto-tuning — auto-tuning can be invoked by an off-to-on transition of bit 1 of word 34.
	4	Always = 0.
	5	Loop-8 PID Integral Term Reset Enable <ul style="list-style-type: none"> 0 = Accumulate PID integral term. 1 = Reset the PID integral term on the 0-to-1 transition, and then allow accumulation until the next 0-to-1 transition.
	6–15	Always = 0.
31	0–15	Loop-8 Standby Temperature Set-point Value — Used when bit 2 of word 30 is off (0 thru 999.9°).
32	0–15	Loop-8 Run Temperature Set-point Value — Used when bit 2 of word 30 is on (0 thru 999.9°).
33	0–15	Loop-8 Manual Output Value (CV) — Used when bit 1 of word 30 is off (–100.00 thru +100.00).
34	0	Read-Block Select <ul style="list-style-type: none"> 0 = Block-transfer read will return the system status block. 1 = Block-transfer read will return the gains block.
	1	Invoke Auto-Tuning <ul style="list-style-type: none"> 0 = Stop auto-tuning. 1 = Invoke auto-tuning of all loops with auto-tuning enable bit turned on. (start only on a 0-to-1 transition).
	2	Always = 0.
	3	Cold-Junction Alarm Enable <ul style="list-style-type: none"> 0 = Disable alarm for temperature over and under limits. 1 = Enable alarm for temperature over the upper limit (70°C) and under the lower limit (0°C).
	4	Celsius/Fahrenheit Select — For all temperature values. <ul style="list-style-type: none"> 0 = Celsius 1 = Fahrenheit
	5–15	Always = 0.30313233

What to do next

To learn how to monitor the system status block of the temperature control module, read chapter 7.

Monitoring Status Data

Chapter Objectives

This chapter shows you how to monitor status data from the 1771-TCM module. This includes.

- sequence of block-transfers
- block identification
- inferred decimal point
- the system status block

Sequence of Block-transfers

At initial start-up, you must write (block-transfer) the dynamic block to the 1771-TCM module to establish its mode of operation. After that, you must send a dynamic block to the module any time you want to change its operating mode.

Thru the dynamic block, you also control the module's response to the execution of a block-transfer read instruction. The module can send either a gains block or a system status block in response to a block-transfer read execution. Whenever you want the module to switch from sending the system status block to sending the gains block or switch from sending the gains block to sending the system status block, you must send a dynamic block to establish that mode of response to block-transfer reads.

Block Identification

The first word of each system status block contains a block identification code (1000 1000 1111 1111 or $88FF_{16}$) that you use to determine that the module has sent a system status block in response to a block-transfer read.

Implied Decimal Point

For the CV value, PID error value, and temperature values, you read a 16-bit signed integer value. However, as you read the value you must be aware of an implied decimal point.

- For the CV value, the implied decimal point is **2** places from the right (causing the resolution to be **0.01%**).
- For the PID error values and the temperature values (words 27 thru 34 and 43 thru 59), the implied decimal point is **1** place from the right (causing the resolution to be **0.1**).

System Status Block

The system status block contains 64 words as follows:

Word	Bits	Description
1	0-15	Block Identification Code — 1000 1000 1111 1111 (88FF ₁₆)
2	0	Loop-1 Enable <ul style="list-style-type: none"> • 0 = Loop 1 disabled. • 1 = Loop 1 enabled.
	1	Loop-1 Auto/Manual Mode Select — (controlled by bit 1 of word 2 of the dynamic block) <ul style="list-style-type: none"> • 0 = Loop 1 is in the manual mode — the manual output value (from word 5, dynamic block) is used as the CV value. • 1 = Loop 1 is in the automatic mode — the PID algorithm generates the CV value.
	2	Loop-1 Open Circuit <ul style="list-style-type: none"> • 0 = Loop-1 thermocouple circuit is closed (connection OK). • 1 = .Loop-1 thermocouple circuit is open (connection broken).
	3	Loop-1 Parameters valid <ul style="list-style-type: none"> • 0 = Power has been interrupted since valid parameters for loop 1 have been block-transferred. • 1 = Valid parameters for loop 1 have been block-transferred since last loss of power .
	4	Loop-1 Calibration Fault <ul style="list-style-type: none"> • 0 = Loop-1 calibration is OK. • 1 = Loop-1 cannot operate with as calibrated.
	5	Loop-1 Set-Point Select — (controlled by bit 2 of word 2 of the dynamic block) <ul style="list-style-type: none"> • 0 = Select the standby-temperature set-point value from word 3 of the dynamic block. • 1 = Select the run-temperature set-point value from word 4 of the dynamic block.
	6	Loop-1 Parameter Value Error <ul style="list-style-type: none"> • 0 = Loop-1 parameter values OK. • 1 = Loop-1 parameter value error.
	7	Loop-1 Auto-Tuning Complete <ul style="list-style-type: none"> • 0 = Loop-1 auto-tuning is not complete. • 1 = Loop-1 auto-tuning is complete.
	8	Reserved.
	9	Reserved.
	10	Loop-1 Thermal Runaway — (set in words 21 and 23 of the configuration block) <ul style="list-style-type: none"> • 0 = Loop-1 is operating within thermal runaway limit.. • 1 = Loop-1 has exceeded the thermal runaway limit. and the CV value has been forced..
	11	Loop-1 High CV Limit — (set in word 7 of the configuration block) <ul style="list-style-type: none"> • 0 = Loop-1 CV value is below the high CV limit. • 1 = Loop-1 CV value is at the high CV limit.
12	Loop-1 Low CV Limit — (set in word 8 of the configuration block) <ul style="list-style-type: none"> • 0 = Loop-1 CV value is above the low CV limit. • 1 = Loop-1 CV value is at the low CV limit. 	

Word	Bits	Description
2	13	Loop-1 CV Ramp Rate — (selected in bit 4 of word 3 of the configuration block) <ul style="list-style-type: none"> • 0 = Loop-1 CV is not ramping. • 1 = Loop-1 CV is ramping at the rate entered in word 4 of the configuration block.
	14	Loop-1 Input High TC Range Alarm — (based on thermocouple type set in bits 12–15 of word 2 of the configuration block) <ul style="list-style-type: none"> • 0 = Loop-1 PV input is below the high TC-range alarm value. • 1 = Loop-1 PV input is at or above the high TC-range alarm value.
	15	Loop-1 Input Low TC-Range Alarm — (based on thermocouple type set in bits 12–15 of word 2 of the configuration block) <ul style="list-style-type: none"> • 0 = Loop-1 PV input is above the low TC-range alarm value. • 1 = Loop-1 PV input is at or below the low TC-range alarm value.
3	0–15	Loop-1 Configuration-Block-Error or Gains-Block-Error Word — Indicates the first configuration-block or gains-block word containing an out-of-range value or incompatible bit selection. (See appendix B for details on locating errors.) <ul style="list-style-type: none"> • 0 = No error detected in configuration block or gains block for loop 1. • 1 thru 23 in the least-significant pair of digits = configuration-block error — (lower-digits value = word containing error). • 1 thru 57 in the upper pair of digits = gains-block error — (upper-digits value = word containing an out-of-range value).
4	0–15	Loop-1 Dynamic-Block-Error Word or Auto-Tuning Error Code — Indicates the first dynamic-block word containing an out-of-range value or an auto-tuning error. (See appendix B for details on locating errors.) <ul style="list-style-type: none"> • 0 = No error detected in dynamic block or in auto-tuning for loop 1. • 1 thru 34 in least-significant pair of digits = dynamic-block error — (lower-digits value = word containing out-of-range value). • 65 thru 67 in the upper pair of digits = a code that indicates an auto-tuning error.

Word	Bits	Description
5	0	Loop-2 Enable <ul style="list-style-type: none"> • 0 = Loop 2 disabled. • 1 = Loop 2 enabled.
	1	Loop-2 Auto/Manual Mode Select — (controlled by bit 1 of word 6 of the dynamic block) <ul style="list-style-type: none"> • 0 = Loop 2 is in the manual mode — the manual output value (from word 9, dynamic block) is used as the CV value. • 1 = Loop 2 is in the automatic mode — the PID algorithm generates the CV value.
	2	Loop-2 Open Circuit <ul style="list-style-type: none"> • 0 = Loop-2 thermocouple circuit is closed (connection OK). • 1 = .Loop-2 thermocouple circuit is open (connection broken).
	3	Loop-2 Parameters valid <ul style="list-style-type: none"> • 0 = Power has been interrupted since valid parameters for loop 2 have been block-transferred. • 1 = Valid parameters for loop 2 have been block-transferred since last loss of power .
	4	Loop-2 Calibration Fault <ul style="list-style-type: none"> • 0 = Loop-2 calibration is OK. • 1 = Loop-2 cannot operate with as calibrated.
	5	Loop-2 Set-Point Select — (controlled by bit 2 of word 6 of the dynamic block) <ul style="list-style-type: none"> • 0 = Select the standby-temperature set-point value from word 7 of the dynamic block. • 1 = Select the run-temperature set-point value from word 8 of the dynamic block.
	6	Loop-2 Parameter Value Error <ul style="list-style-type: none"> • 0 = Loop-2 parameter values OK. • 1 = Loop-2 parameter value error.
	7	Loop-2 Auto-Tuning Complete <ul style="list-style-type: none"> • 0 = Loop-2 auto-tuning is not complete. • 1 = Loop-2 auto-tuning is complete.
	8	Reserved.
	9	Reserved.
	10	Loop-2 Thermal Runaway — (set in words 22 and 23 of the configuration block) <ul style="list-style-type: none"> • 0 = Loop-2 is operating within thermal runaway limit.. • 1 = Loop-2 has exceeded the thermal runaway limit. and the CV value has been forced..
	11	Loop-2 High CV Limit — (set in word 7 of the configuration block) <ul style="list-style-type: none"> • 0 = Loop-2 CV value is below the high CV limit. • 1 = Loop-2 CV value is at the high CV limit.
12	Loop-2 Low CV Limit — (set in word 8 of the configuration block) <ul style="list-style-type: none"> • 0 = Loop-2 CV value is above the low CV limit. • 1 = Loop-2 CV value is at the low CV limit. 	

Word	Bits	Description
5	13	Loop-2 CV Ramp Rate — (selected in bit 4 of word 3 of the configuration block) <ul style="list-style-type: none"> • 0 = Loop-2 CV is not ramping. • 1 = Loop-2 CV is ramping at the rate entered in word 4 of the configuration block.
	14	Loop-2 Input High TC Range Alarm — (based on thermocouple type set in bits 12–15 of word 2 of the configuration block) <ul style="list-style-type: none"> • 0 = Loop-2 PV input is below the high TC-range alarm value. • 1 = Loop-2 PV input is at or above the high TC-range alarm value.
	15	Loop-2 Input Low TC-Range Alarm — (based on thermocouple type set in bits 12–15 of word 2 of the configuration block) <ul style="list-style-type: none"> • 0 = Loop-2 PV input is above the low TC-range alarm value. • 1 = Loop-2 PV input is at or below the low TC-range alarm value.
6	0–15	Loop-2 Configuration-Block-Error or Gains-Block-Error Word — Indicates the first configuration-block or gains-block word containing an out-of-range value or incompatible bit selection. (See appendix B for details on locating errors.) <ul style="list-style-type: none"> • 0 = No error detected in configuration block or gains block for loop 2. • 1 thru 23 in the least-significant pair of digits = configuration-block error — (lower-digits value = word containing error). • 1 thru 57 in the upper pair of digits = gains-block error — (upper-digits value = word containing an out-of-range value).
7	0–15	Loop-2 Dynamic-Block-Error Word or Auto-Tuning Error Code — Indicates the first dynamic-block word containing an out-of-range value or an auto-tuning error. (See appendix B for details on locating errors.) <ul style="list-style-type: none"> • 0 = No error detected in dynamic block or in auto-tuning for loop 2. • 1 thru 34 in least-significant pair of digits = dynamic-block error — (lower-digits value = word containing out-of-range value). • 65 thru 67 in the upper pair of digits = a code that indicates an auto-tuning error.

Word	Bits	Description
8	0	Loop-3 Enable <ul style="list-style-type: none"> • 0 = Loop 3 disabled. • 1 = Loop 3 enabled.
	1	Loop-3 Auto/Manual Mode Select — (controlled by bit 1 of word 1 of the dynamic block) <ul style="list-style-type: none"> • 0 = Loop 3 is in the manual mode — the manual output value (from word 13, dynamic block) is used as the CV value. • 1 = Loop 3 is in the automatic mode — the PID algorithm generates the CV value.
	2	Loop-3 Open Circuit <ul style="list-style-type: none"> • 0 = Loop-3 thermocouple circuit is closed (connection OK). • 1 = .Loop-3 thermocouple circuit is open (connection broken).
	3	Loop-3 Parameters valid <ul style="list-style-type: none"> • 0 = Power has been interrupted since valid parameters for loop 3 have been block-transferred. • 1 = Valid parameters for loop 3 have been block-transferred since last loss of power .
	4	Loop-3 Calibration Fault <ul style="list-style-type: none"> • 0 = Loop-3 calibration is OK. • 1 = Loop-3 cannot operate with as calibrated.
	5	Loop-3 Set-Point Select — (controlled by bit 2 of word 10 of the dynamic block) <ul style="list-style-type: none"> • 0 = Select the standby-temperature set-point value from word 11 of the dynamic block. • 1 = Select the run-temperature set-point value from word 12 of the dynamic block.
	6	Loop-3 Parameter Value Error <ul style="list-style-type: none"> • 0 = Loop-3 parameter values OK. • 1 = Loop-3 parameter value error.
	7	Loop-3 Auto-Tuning Complete <ul style="list-style-type: none"> • 0 = Loop-3 auto-tuning is not complete. • 1 = Loop-3 auto-tuning is complete.
	8	Reserved.
	9	Reserved.
	10	Loop-3 Thermal Runaway — (set in words 22 and 23 of the configuration block) <ul style="list-style-type: none"> • 0 = Loop-3 is operating within thermal runaway limit.. • 1 = Loop-3 has exceeded the thermal runaway limit. and the CV value has been forced..
	11	Loop-3 High CV Limit — (set in word 7 of the configuration block) <ul style="list-style-type: none"> • 0 = Loop-3 CV value is below the high CV limit. • 1 = Loop-3 CV value is at the high CV limit.
12	Loop-3 Low CV Limit — (set in word 8 of the configuration block) <ul style="list-style-type: none"> • 0 = Loop-3 CV value is above the low CV limit. • 1 = Loop-3 CV value is at the low CV limit. 	

Word	Bits	Description
8	13	Loop-3 CV Ramp Rate — (selected in bit 4 of word 3 of the configuration block) <ul style="list-style-type: none"> • 0 = Loop-3 CV is not ramping. • 1 = Loop-3 CV is ramping at the rate entered in word 4 of the configuration block.
	14	Loop-3 Input High TC Range Alarm — (based on thermocouple type set in bits 12–15 of word 2 of the configuration block) <ul style="list-style-type: none"> • 0 = Loop-3 PV input is below the high TC-range alarm value. • 1 = Loop-3 PV input is at or above the high TC-range alarm value.
	15	Loop-3 Input Low TC-Range Alarm — (based on thermocouple type set in bits 12–15 of word 2 of the configuration block) <ul style="list-style-type: none"> • 0 = Loop-3 PV input is above the low TC-range alarm value. • 1 = Loop-3 PV input is at or below the low TC-range alarm value.
9	0–15	Loop-3 Configuration-Block-Error or Gains-Block-Error Word — Indicates the first configuration-block or gains-block word containing an out-of-range value or incompatible bit selection. (See appendix B for details on locating errors.) <ul style="list-style-type: none"> • 0 = No error detected in configuration block or gains block for loop 3. • 1 thru 23 in the least-significant pair of digits = configuration-block error — (lower-digits value = word containing error). • 1 thru 57 in the upper pair of digits = gains-block error — (upper-digits value = word containing an out-of-range value).
10	0–15	Loop-3 Dynamic-Block-Error Word or Auto-Tuning Error Code — Indicates the first dynamic-block word containing an out-of-range value or an auto-tuning error. (See appendix B for details on locating errors.) <ul style="list-style-type: none"> • 0 = No error detected in dynamic block or in auto-tuning for loop 3. • 1 thru 34 in least-significant pair of digits = dynamic-block error — (lower-digits value = word containing out-of-range value). • 65 thru 67 in the upper pair of digits = a code that indicates an auto-tuning error.

Word	Bits	Description
11	0	Loop-4 Enable <ul style="list-style-type: none"> • 0 = Loop 4 disabled. • 1 = Loop 4 enabled.
	1	Loop-4 Auto/Manual Mode Select — (controlled by bit 1 of word 14 of the dynamic block) <ul style="list-style-type: none"> • 0 = Loop 4 is in the manual mode — the manual output value (from word 17, dynamic block) is used as the CV value. • 1 = Loop 4 is in the automatic mode — the PID algorithm generates the CV value.
	2	Loop-4 Open Circuit <ul style="list-style-type: none"> • 0 = Loop-4 thermocouple circuit is closed (connection OK). • 1 = .Loop-4 thermocouple circuit is open (connection broken).
	3	Loop-4 Parameters valid <ul style="list-style-type: none"> • 0 = Power has been interrupted since valid parameters for loop 4 have been block-transferred. • 1 = Valid parameters for loop 4 have been block-transferred since last loss of power .
	4	Loop-4 Calibration Fault <ul style="list-style-type: none"> • 0 = Loop-4 calibration is OK. • 1 = Loop-4 cannot operate with as calibrated.
	5	Loop-4 Set-Point Select — (controlled by bit 2 of word 14 of the dynamic block) <ul style="list-style-type: none"> • 0 = Select the standby-temperature set-point value from word 15 of the dynamic block. • 1 = Select the run-temperature set-point value from word 16 of the dynamic block.
	6	Loop-4 Parameter Value Error <ul style="list-style-type: none"> • 0 = Loop-4 parameter values OK. • 1 = Loop-4 parameter value error.
	7	Loop-4 Auto-Tuning Complete <ul style="list-style-type: none"> • 0 = Loop-4 auto-tuning is not complete. • 1 = Loop-4 auto-tuning is complete.
	8	Reserved.
	9	Reserved.
	10	Loop-4 Thermal Runaway — (set in words 22 and 23 of the configuration block) <ul style="list-style-type: none"> • 0 = Loop-4 is operating within thermal runaway limit.. • 1 = Loop-4 has exceeded the thermal runaway limit. and the CV value has been forced..
	11	Loop-4 High CV Limit — (set in word 7 of the configuration block) <ul style="list-style-type: none"> • 0 = Loop-4 CV value is below the high CV limit. • 1 = Loop-4 CV value is at the high CV limit.
12	Loop-4 Low CV Limit — (set in word 8 of the configuration block) <ul style="list-style-type: none"> • 0 = Loop-4 CV value is above the low CV limit. • 1 = Loop-4 CV value is at the low CV limit. 	

Word	Bits	Description
11	13	<p>Loop-4 CV Ramp Rate — (selected in bit 4 of word 3 of the configuration block)</p> <ul style="list-style-type: none"> • 0 = Loop-4 CV is not ramping. • 1 = Loop-4 CV is ramping at the rate entered in word 4 of the configuration block.
	14	<p>Loop-4 Input High TC Range Alarm — (based on thermocouple type set in bits 12–15 of word 2 of the configuration block)</p> <ul style="list-style-type: none"> • 0 = Loop-4 PV input is below the high TC-range alarm value. • 1 = Loop-4 PV input is at or above the high TC-range alarm value.
	15	<p>Loop-4 Input Low TC-Range Alarm — (based on thermocouple type set in bits 12–15 of word 2 of the configuration block)</p> <ul style="list-style-type: none"> • 0 = Loop-4 PV input is above the low TC-range alarm value. • 1 = Loop-4 PV input is at or below the low TC-range alarm value.
12	0–15	<p>Loop-4 Configuration-Block-Error or Gains-Block-Error Word — Indicates the first configuration-block or gains-block word containing an out-of-range value or incompatible bit selection. (See appendix B for details on locating errors.)</p> <ul style="list-style-type: none"> • 0 = No error detected in configuration block or gains block for loop 4. • 1 thru 23 in the least-significant pair of digits = configuration-block error — (lower-digits value = word containing error). • 1 thru 57 in the upper pair of digits = gains-block error — (upper-digits value = word containing an out-of-range value).
13	0–15	<p>Loop-4 Dynamic-Block-Error Word or Auto-Tuning Error Code — Indicates the first dynamic-block word containing an out-of-range value or an auto-tuning error. (See appendix B for details on locating errors.)</p> <ul style="list-style-type: none"> • 0 = No error detected in dynamic block or in auto-tuning for loop 4. • 1 thru 34 in least-significant pair of digits = dynamic-block error — (lower-digits value = word containing out-of-range value). • 65 thru 67 in the upper pair of digits = a code that indicates an auto-tuning error.

Word	Bits	Description
14	0	Loop-5 Enable <ul style="list-style-type: none"> • 0 = Loop 5 disabled. • 1 = Loop 5 enabled.
	1	Loop-5 Auto/Manual Mode Select — (controlled by bit 1 of word 18 of the dynamic block) <ul style="list-style-type: none"> • 0 = Loop 5 is in the manual mode — the manual output value (from word 21, dynamic block) is used as the CV value. • 1 = Loop 5 is in the automatic mode — the PID algorithm generates the CV value.
	2	Loop-5 Open Circuit <ul style="list-style-type: none"> • 0 = Loop-5 thermocouple circuit is closed (connection OK). • 1 = .Loop-5 thermocouple circuit is open (connection broken).
	3	Loop-5 Parameters valid <ul style="list-style-type: none"> • 0 = Power has been interrupted since valid parameters for loop 5 have been block-transferred. • 1 = Valid parameters for loop 5 have been block-transferred since last loss of power .
	4	Loop-5 Calibration Fault <ul style="list-style-type: none"> • 0 = Loop-5 calibration is OK. • 1 = Loop-5 cannot operate with as calibrated.
	5	Loop-5 Set-Point Select — (controlled by bit 2 of word 18 of the dynamic block) <ul style="list-style-type: none"> • 0 = Select the standby-temperature set-point value from word 19 of the dynamic block. • 1 = Select the run-temperature set-point value from word 20 of the dynamic block.
	6	Loop-5 Parameter Value Error <ul style="list-style-type: none"> • 0 = Loop-5 parameter values OK. • 1 = Loop-5 parameter value error.
	7	Loop-5 Auto-Tuning Complete <ul style="list-style-type: none"> • 0 = Loop-5 auto-tuning is not complete. • 1 = Loop-5 auto-tuning is complete.
	8	Reserved.
	9	Reserved.
	10	Loop-5 Thermal Runaway — (set in words 22 and 23 of the configuration block) <ul style="list-style-type: none"> • 0 = Loop-5 is operating within thermal runaway limit.. • 1 = Loop-5 has exceeded the thermal runaway limit. and the CV value has been forced..
	11	Loop-5 High CV Limit — (set in word 7 of the configuration block) <ul style="list-style-type: none"> • 0 = Loop-5 CV value is below the high CV limit. • 1 = Loop-5 CV value is at the high CV limit.
12	Loop-5 Low CV Limit — (set in word 8 of the configuration block) <ul style="list-style-type: none"> • 0 = Loop-5 CV value is above the low CV limit. • 1 = Loop-5 CV value is at the low CV limit. 	

Word	Bits	Description
14	13	<p>Loop-5 CV Ramp Rate — (selected in bit 4 of word 3 of the configuration block)</p> <ul style="list-style-type: none"> • 0 = Loop-5 CV is not ramping. • 1 = Loop-5 CV is ramping at the rate entered in word 4 of the configuration block.
	14	<p>Loop-5 Input High TC Range Alarm — (based on thermocouple type set in bits 12–15 of word 2 of the configuration block)</p> <ul style="list-style-type: none"> • 0 = Loop-5 PV input is below the high TC-range alarm value. • 1 = Loop-5 PV input is at or above the high TC-range alarm value.
	15	<p>Loop-5 Input Low TC-Range Alarm — (based on thermocouple type set in bits 12–15 of word 2 of the configuration block)</p> <ul style="list-style-type: none"> • 0 = Loop-5 PV input is above the low TC-range alarm value. • 1 = Loop-5 PV input is at or below the low TC-range alarm value.
15	0–15	<p>Loop-5 Configuration-Block-Error or Gains-Block-Error Word — Indicates the first configuration-block or gains-block word containing an out-of-range value or incompatible bit selection. (See appendix B for details on locating errors.)</p> <ul style="list-style-type: none"> • 0 = No error detected in configuration block or gains block for loop 5. • 1 thru 23 in the least-significant pair of digits = configuration-block error — (lower-digits value = word containing error). • 1 thru 57 in the upper pair of digits = gains-block error — (upper-digits value = word containing an out-of-range value).
16	0–15	<p>Loop-5 Dynamic-Block-Error Word or Auto-Tuning Error Code — Indicates the first dynamic-block word containing an out-of-range value or an auto-tuning error. (See appendix B for details on locating errors.)</p> <ul style="list-style-type: none"> • 0 = No error detected in dynamic block or in auto-tuning for loop 5. • 1 thru 34 in least-significant pair of digits = dynamic-block error — (lower-digits value = word containing out-of-range value). • 65 thru 67 in the upper pair of digits = a code that indicates an auto-tuning error.

Word	Bits	Description
17	0	Loop-6 Enable <ul style="list-style-type: none"> • 0 = Loop 6 disabled. • 1 = Loop 6 enabled.
	1	Loop-6 Auto/Manual Mode Select — (controlled by bit 1 of word 22 of the dynamic block) <ul style="list-style-type: none"> • 0 = Loop 6 is in the manual mode — the manual output value (from word 25, dynamic block) is used as the CV value. • 1 = Loop 6 is in the automatic mode — the PID algorithm generates the CV value.
	2	Loop-6 Open Circuit <ul style="list-style-type: none"> • 0 = Loop-6 thermocouple circuit is closed (connection OK). • 1 = .Loop-6 thermocouple circuit is open (connection broken).
	3	Loop-6 Parameters valid <ul style="list-style-type: none"> • 0 = Power has been interrupted since valid parameters for loop 6 have been block-transferred. • 1 = Valid parameters for loop 6 have been block-transferred since last loss of power .
	4	Loop-6 Calibration Fault <ul style="list-style-type: none"> • 0 = Loop-1 calibration is OK. • 1 = Loop-1 cannot operate with as calibrated.
	5	Loop-6 Set-Point Select — (controlled by bit 2 of word 22 of the dynamic block) <ul style="list-style-type: none"> • 0 = Select the standby-temperature set-point value from word 23 of the dynamic block. • 1 = Select the run-temperature set-point value from word 24 of the dynamic block.
	6	Loop-6 Parameter Value Error <ul style="list-style-type: none"> • 0 = Loop-6 parameter values OK. • 1 = Loop-6 parameter value error.
	7	Loop-6 Auto-Tuning Complete <ul style="list-style-type: none"> • 0 = Loop-6 auto-tuning is not complete. • 1 = Loop-6 auto-tuning is complete.
	8	Reserved.
	9	Reserved.
	10	Loop-6 Thermal Runaway — (set in words 22 and 23 of the configuration block) <ul style="list-style-type: none"> • 0 = Loop-6 is operating within thermal runaway limit.. • 1 = Loop-6 has exceeded the thermal runaway limit. and the CV value has been forced..
	11	Loop-6 High CV Limit — (set in word 7 of the configuration block) <ul style="list-style-type: none"> • 0 = Loop-6 CV value is below the high CV limit. • 1 = Loop-6 CV value is at the high CV limit.
12	Loop-6 Low CV Limit — (set in word 8 of the configuration block) <ul style="list-style-type: none"> • 0 = Loop-6 CV value is above the low CV limit. • 1 = Loop-6 CV value is at the low CV limit. 	

Word	Bits	Description
17	13	Loop-6 CV Ramp Rate — (selected in bit 4 of word 3 of the configuration block) <ul style="list-style-type: none"> • 0 = Loop-6 CV is not ramping. • 1 = Loop-6 CV is ramping at the rate entered in word 4 of the configuration block.
	14	Loop-6 Input High TC Range Alarm — (based on thermocouple type set in bits 12–15 of word 2 of the configuration block) <ul style="list-style-type: none"> • 0 = Loop-6 PV input is below the high TC-range alarm value. • 1 = Loop-6 PV input is at or above the high TC-range alarm value.
	15	Loop-6 Input Low TC-Range Alarm — (based on thermocouple type set in bits 12–15 of word 2 of the configuration block) <ul style="list-style-type: none"> • 0 = Loop-6 PV input is above the low TC-range alarm value. • 1 = Loop-6 PV input is at or below the low TC-range alarm value.
18	0–15	Loop-6 Configuration-Block-Error or Gains-Block-Error Word — Indicates the first configuration-block or gains-block word containing an out-of-range value or incompatible bit selection. (See appendix B for details on locating errors.) <ul style="list-style-type: none"> • 0 = No error detected in configuration block or gains block for loop 6. • 1 thru 23 in the least-significant pair of digits = configuration-block error — (lower-digits value = word containing error). • 1 thru 57 in the upper pair of digits = gains-block error — (upper-digits value = word containing an out-of-range value).
19	0–15	Loop-6 Dynamic-Block-Error Word or Auto-Tuning Error Code — Indicates the first dynamic-block word containing an out-of-range value or an auto-tuning error. (See appendix B for details on locating errors.) <ul style="list-style-type: none"> • 0 = No error detected in dynamic block or in auto-tuning for loop 6. • 1 thru 34 in least-significant pair of digits = dynamic-block error — (lower-digits value = word containing out-of-range value). • 65 thru 67 in the upper pair of digits = a code that indicates an auto-tuning error.

Word	Bits	Description
20	0	Loop-7 Enable <ul style="list-style-type: none"> • 0 = Loop 7 disabled. • 1 = Loop 7 enabled.
	1	Loop-7 Auto/Manual Mode Select — (controlled by bit 1 of word 26 of the dynamic block) <ul style="list-style-type: none"> • 0 = Loop 7 is in the manual mode — the manual output value (from word 29, dynamic block) is used as the CV value. • 1 = Loop 7 is in the automatic mode — the PID algorithm generates the CV value.
	2	Loop-7 Open Circuit <ul style="list-style-type: none"> • 0 = Loop-7 thermocouple circuit is closed (connection OK). • 1 = .Loop-7 thermocouple circuit is open (connection broken).
	3	Loop-7 Parameters valid <ul style="list-style-type: none"> • 0 = Power has been interrupted since valid parameters for loop 7 have been block-transferred. • 1 = Valid parameters for loop 7 have been block-transferred since last loss of power .
	4	Loop-7 Calibration Fault <ul style="list-style-type: none"> • 0 = Loop-7 calibration is OK. • 1 = Loop-7 cannot operate with as calibrated.
	5	Loop-7 Set-Point Select — (controlled by bit 2 of word 26 of the dynamic block) <ul style="list-style-type: none"> • 0 = Select the standby-temperature set-point value from word 27 of the dynamic block. • 1 = Select the run-temperature set-point value from word 28 of the dynamic block.
	6	Loop-7 Parameter Value Error <ul style="list-style-type: none"> • 0 = Loop-7 parameter values OK. • 1 = Loop-7 parameter value error.
	7	Loop-7 Auto-Tuning Complete <ul style="list-style-type: none"> • 0 = Loop-7 auto-tuning is not complete. • 1 = Loop-7 auto-tuning is complete.
	8	Reserved.
	9	Reserved.
	10	Loop-7 Thermal Runaway — (set in words 22 and 23 of the configuration block) <ul style="list-style-type: none"> • 0 = Loop-7 is operating within thermal runaway limit.. • 1 = Loop-7 has exceeded the thermal runaway limit. and the CV value has been forced..
	11	Loop-7 High CV Limit — (set in word 7 of the configuration block) <ul style="list-style-type: none"> • 0 = Loop-7 CV value is below the high CV limit. • 1 = Loop-7 CV value is at the high CV limit.
12	Loop-7 Low CV Limit — (set in word 8 of the configuration block) <ul style="list-style-type: none"> • 0 = Loop-7 CV value is above the low CV limit. • 1 = Loop-7 CV value is at the low CV limit. 	

Word	Bits	Description
20	13	Loop-7 CV Ramp Rate — (selected in bit 4 of word 3 of the configuration block) <ul style="list-style-type: none"> • 0 = Loop-7 CV is not ramping. • 1 = Loop-7 CV is ramping at the rate entered in word 4 of the configuration block.
	14	Loop-7 Input High TC Range Alarm — (based on thermocouple type set in bits 12–15 of word 2 of the configuration block) <ul style="list-style-type: none"> • 0 = Loop-7 PV input is below the high TC-range alarm value. • 1 = Loop-7 PV input is at or above the high TC-range alarm value.
	15	Loop-7 Input Low TC-Range Alarm — (based on thermocouple type set in bits 12–15 of word 2 of the configuration block) <ul style="list-style-type: none"> • 0 = Loop-7 PV input is above the low TC-range alarm value. • 1 = Loop-7 PV input is at or below the low TC-range alarm value.
21	0–15	Loop-7 Configuration-Block-Error or Gains-Block-Error Word — Indicates the first configuration-block or gains-block word containing an out-of-range value or incompatible bit selection. (See appendix B for details on locating errors.) <ul style="list-style-type: none"> • 0 = No error detected in configuration block or gains block for loop 7. • 1 thru 23 in the least-significant pair of digits = configuration-block error — (lower-digits value = word containing error). • 1 thru 57 in the upper pair of digits = gains-block error — (upper-digits value = word containing an out-of-range value).
22	0–15	Loop-7 Dynamic-Block-Error Word or Auto-Tuning Error Code — Indicates the first dynamic-block word containing an out-of-range value or an auto-tuning error. (See appendix B for details on locating errors.) <ul style="list-style-type: none"> • 0 = No error detected in dynamic block or in auto-tuning for loop 7. • 1 thru 34 in least-significant pair of digits = dynamic-block error — (lower-digits value = word containing out-of-range value). • 65 thru 67 in the upper pair of digits = a code that indicates an auto-tuning error.

Word	Bits	Description
23	0	Loop-8 Enable <ul style="list-style-type: none"> • 0 = Loop 8 disabled. • 1 = Loop 8 enabled.
	1	Loop-8 Auto/Manual Mode Select — (controlled by bit 1 of word 30 of the dynamic block) <ul style="list-style-type: none"> • 0 = Loop 8 is in the manual mode — the manual output value (from word 33, dynamic block) is used as the CV value. • 1 = Loop 8 is in the automatic mode — the PID algorithm generates the CV value.
	2	Loop-8 Open Circuit <ul style="list-style-type: none"> • 0 = Loop-8 thermocouple circuit is closed (connection OK). • 1 = .Loop-8 thermocouple circuit is open (connection broken).
	3	Loop-8 Parameters valid <ul style="list-style-type: none"> • 0 = Power has been interrupted since valid parameters for loop 8 have been block-transferred. • 1 = Valid parameters for loop 8 have been block-transferred since last loss of power .
	4	Loop-8 Calibration Fault <ul style="list-style-type: none"> • 0 = Loop-8 calibration is OK. • 1 = Loop-8 cannot operate with as calibrated.
	5	Loop-8 Set-Point Select — (controlled by bit 2 of word 30 of the dynamic block) <ul style="list-style-type: none"> • 0 = Select the standby-temperature set-point value from word 31 of the dynamic block. • 1 = Select the run-temperature set-point value from word 32 of the dynamic block.
	6	Loop-8 Parameter Value Error <ul style="list-style-type: none"> • 0 = Loop-8 parameter values OK. • 1 = Loop-8 parameter value error.
	7	Loop-8 Auto-Tuning Complete <ul style="list-style-type: none"> • 0 = Loop-8 auto-tuning is not complete. • 1 = Loop-8 auto-tuning is complete.
	8	Reserved.
	9	Reserved.
	10	Loop-8 Thermal Runaway — (set in words 22 and 23 of the configuration block) <ul style="list-style-type: none"> • 0 = Loop-8 is operating within thermal runaway limit.. • 1 = Loop-8 has exceeded the thermal runaway limit. and the CV value has been forced..
	11	Loop-8 High CV Limit — (set in word 7 of the configuration block) <ul style="list-style-type: none"> • 0 = Loop-8 CV value is below the high CV limit. • 1 = Loop-8 CV value is at the high CV limit.
12	Loop-8 Low CV Limit — (set in word 8 of the configuration block) <ul style="list-style-type: none"> • 0 = Loop-8 CV value is above the low CV limit. • 1 = Loop-8 CV value is at the low CV limit. 	

Word	Bits	Description
23	13	Loop-8 CV Ramp Rate — (selected in bit 4 of word 3 of the configuration block) <ul style="list-style-type: none"> • 0 = Loop-8 CV is not ramping. • 1 = Loop-8 CV is ramping at the rate entered in word 4 of the configuration block.
	14	Loop-8 Input High TC Range Alarm — (based on thermocouple type set in bits 12–15 of word 2 of the configuration block) <ul style="list-style-type: none"> • 0 = Loop-8 PV input is below the high TC-range alarm value. • 1 = Loop-8 PV input is at or above the high TC-range alarm value.
	15	Loop-8 Input Low TC-Range Alarm — (based on thermocouple type set in bits 12–15 of word 2 of the configuration block) <ul style="list-style-type: none"> • 0 = Loop-8 PV input is above the low TC-range alarm value. • 1 = Loop-8 PV input is at or below the low TC-range alarm value.
24	0–15	Loop-8 Configuration-Block-Error or Gains-Block-Error Word — Indicates the first configuration-block or gains-block word containing an out-of-range value or incompatible bit selection. (See appendix B for details on locating errors.) <ul style="list-style-type: none"> • 0 = No error detected in configuration block or gains block for loop 8. • 1 thru 23 in the least-significant pair of digits = configuration-block error — (lower-digits value = word containing error). • 1 thru 57 in the upper pair of digits = gains-block error — (upper-digits value = word containing an out-of-range value).
25	0–15	Loop-8 Dynamic-Block-Error Word or Auto-Tuning Error Code — Indicates the first dynamic-block word containing an out-of-range value or an auto-tuning error. (See appendix B for details on locating errors.) <ul style="list-style-type: none"> • 0 = No error detected in dynamic block or in auto-tuning for loop 8. • 1 thru 34 in least-significant pair of digits = dynamic-block error — (lower-digits value = word containing out-of-range value). • 65 thru 67 in the upper pair of digits = a code that indicates an auto-tuning error.
26	0	Loop-1 Heat TPO Bit
	1	Loop-2 Heat TPO Bit
	2	Loop-3 Heat TPO Bit
	3	Loop-4 Heat TPO Bit
	4	Loop-5 Heat TPO Bit
	5	Loop-6 Heat TPO Bit
	6	Loop-7 Heat TPO Bit
	7	Loop-8 Heat TPO Bit
	8	Loop-1 Cool TPO Bit
	9	Loop-2 Cool TPO Bit
	10	Loop-3 Cool TPO Bit
	11	Loop-4 Cool TPO Bit
	12	Loop-5 Cool TPO Bit
	13	Loop-6 Cool TPO Bit
	14	Loop-7 Cool TPO Bit
15	Loop-8 Cool TPO Bit	

Chapter 7
Monitoring Status Data

Word	Bits	Description
27	0-15	Loop-1 Temperature — (range is dependant upon thermocouple type and C/F selection)
28	0-15	Loop-2 Temperature — (range is dependant upon thermocouple type and C/F selection)
29	0-15	Loop-3 Temperature — (range is dependant upon thermocouple type and C/F selection)
30	0-15	Loop-4 Temperature — (range is dependant upon thermocouple type and C/F selection)
31	0-15	Loop-5 Temperature — (range is dependant upon thermocouple type and C/F selection)
32	0-15	Loop-6 Temperature — (range is dependant upon thermocouple type and C/F selection)
33	0-15	Loop-7 Temperature — (range is dependant upon thermocouple type and C/F selection)
34	0-15	Loop-8 Temperature — (range is dependant upon thermocouple type and C/F selection)
35	0-15	Loop-1 CV Value — (-100.00% thru +100.00%)
36	0-15	Loop-2 CV Value — (-100.00% thru +100.00%)
37	0-15	Loop-3 CV Value — (-100.00% thru +100.00%)
38	0-15	Loop-4 CV Value — (-100.00% thru +100.00%)
39	0-15	Loop-5 CV Value — (-100.00% thru +100.00%)
40	0-15	Loop-6 CV Value — (-100.00% thru +100.00%)
41	0-15	Loop-7 CV Value — (-100.00% thru +100.00%)
42	0-15	Loop-8 CV Value — (-100.00% thru +100.00%)
43	0-15	Loop-1 Current Set-Point Value — (0 thru 999.9°)
44	0-15	Loop-2 Current Set-Point Value — (0 thru 999.9°)
45	0-15	Loop-3 Current Set-Point Value — (0 thru 999.9°)
46	0-15	Loop-4 Current Set-Point Value — (0 thru 999.9°)
47	0-15	Loop-5 Current Set-Point Value — (0 thru 999.9°)
48	0-15	Loop-6 Current Set-Point Value — (0 thru 999.9°)
49	0-15	Loop-7 Current Set-Point Value — (0 thru 999.9°)
50	0-15	Loop-8 Current Set-Point Value — (0 thru 999.9°)
51	0-15	Loop-1 PID Error Value — (-3276.7° thru +3276.7°)
52	0-15	Loop-2 PID Error Value — (-3276.7° thru +3276.7°)
53	0-15	Loop-3 PID Error Value — (-3276.7° thru +3276.7°)
54	0-15	Loop-4 PID Error Value — (-3276.7° thru +3276.7°)
55	0-15	Loop-5 PID Error Value — (-3276.7° thru +3276.7°)
56	0-15	Loop-6 PID Error Value — (-3276.7° thru +3276.7°)

Word	Bits	Description
57	0–15	Loop-7 PID Error Value — (–3276.7° thru +3276.7°)
58	0–15	Loop-8 PID Error Value — (–3276.7° thru +3276.7°)
59	0–15	Cold-Junction-Compensation Temperature — (0°C thru +70.0°C)
60	0	Cold-Junction-Compensation Temperature Low Alarm — (0°C thru +70°C) <ul style="list-style-type: none"> • 0 = Cold-junction-compensation temperature is 0°C or above. • 1 = Cold-junction-compensation temperature is below 0°C.
	1	Cold-Junction-Compensation Temperature High Alarm — (0°C thru +70°C) <ul style="list-style-type: none"> • 0 = Cold-junction-compensation temperature is 70°C or below. • 1 = Cold-junction-compensation temperature is above 70°C.
	2	Auto-Tuning in Progress — (controlled by bit 1 of word 34 of the dynamic block) <ul style="list-style-type: none"> • 0 = Auto-tuning not in progress • 1 = Auto-tuning in progress
	3–15	Reserved.
61	0	Loop-1 Input Low Temperature Alarm — (set in word 17 of the configuration block) <ul style="list-style-type: none"> • 0 = Loop-1 PV input is above the low temperature alarm value. • 1 = Loop-1 PV input is at or below the low temperature alarm value.
	1	Loop-2 Input Low Temperature Alarm — (set in word 17 of the configuration block) <ul style="list-style-type: none"> • 0 = Loop-2 PV input is above the low temperature alarm value. • 1 = Loop-2 PV input is at or below the low temperature alarm value.
	2	Loop-3 Input Low Temperature Alarm — (set in word 17 of the configuration block) <ul style="list-style-type: none"> • 0 = Loop-3 PV input is above the low temperature alarm value. • 1 = Loop-3 PV input is at or below the low temperature alarm value.
	3	Loop-4 Input Low Temperature Alarm — (set in word 17 of the configuration block) <ul style="list-style-type: none"> • 0 = Loop-4 PV input is above the low temperature alarm value. • 1 = Loop-4 PV input is at or below the low temperature alarm value.
	4	Loop-5 Input Low Temperature Alarm — (set in word 17 of the configuration block) <ul style="list-style-type: none"> • 0 = Loop-5 PV input is above the low temperature alarm value. • 1 = Loop-5 PV input is at or below the low temperature alarm value.
	5	Loop-6 Input Low Temperature Alarm — (set in word 17 of the configuration block) <ul style="list-style-type: none"> • 0 = Loop-6 PV input is above the low temperature alarm value. • 1 = Loop-6 PV input is at or below the low temperature alarm value.
	6	Loop-7 Input Low Temperature Alarm — (set in word 17 of the configuration block) <ul style="list-style-type: none"> • 0 = Loop-7 PV input is above the low temperature alarm value. • 1 = Loop-7 PV input is at or below the low temperature alarm value.
	7	Loop-8 Input Low Temperature Alarm — (set in word 17 of the configuration block) <ul style="list-style-type: none"> • 0 = Loop-8 PV input is above the low temperature alarm value. • 1 = Loop-8 PV input is at or below the low temperature alarm value.

Word	Bits	Description
61	8	Loop-1 Input High Temperature Alarm — (set in word 18 of the configuration block) <ul style="list-style-type: none"> • 0 = Loop-1 PV input is below the high temperature alarm value. • 1 = Loop-1 PV input is at or above the high temperature alarm value.
	9	Loop-2 Input High Temperature Alarm — (set in word 18 of the configuration block) <ul style="list-style-type: none"> • 0 = Loop-2 PV input is below the high temperature alarm value. • 1 = Loop-2 PV input is at or above the high temperature alarm value.
	10	Loop-3 Input High Temperature Alarm — (set in word 18 of the configuration block) <ul style="list-style-type: none"> • 0 = Loop-3 PV input is below the high temperature alarm value. • 1 = Loop-3 PV input is at or above the high temperature alarm value.
	11	Loop-4 Input High Temperature Alarm — (set in word 18 of the configuration block) <ul style="list-style-type: none"> • 0 = Loop-4 PV input is below the high temperature alarm value. • 1 = Loop-4 PV input is at or above the high temperature alarm value.
	12	Loop-5 Input High Temperature Alarm — (set in word 18 of the configuration block) <ul style="list-style-type: none"> • 0 = Loop-4 PV input is below the high temperature alarm value. • 1 = Loop-4 PV input is at or above the high temperature alarm value.
	13	Loop-6 Input High Temperature Alarm — (set in word 18 of the configuration block) <ul style="list-style-type: none"> • 0 = Loop-5 PV input is below the high temperature alarm value. • 1 = Loop-5 PV input is at or above the high temperature alarm value.
	14	Loop-7 Input High Temperature Alarm — (set in word 18 of the configuration block) <ul style="list-style-type: none"> • 0 = Loop-6 PV input is below the high temperature alarm value. • 1 = Loop-6 PV input is at or above the high temperature alarm value.
	15	Loop-8 Input High Temperature Alarm — (set in word 18 of the configuration block) <ul style="list-style-type: none"> • 0 = Loop-7 PV input is below the high temperature alarm value. • 1 = Loop-7 PV input is at or above the high temperature alarm value.

Word	Bits	Description
62	0	Loop-1 Low Deviation Alarm — (set in word 19 of the configuration block) <ul style="list-style-type: none"> • 0 = Loop-1 PV input is above the low deviation alarm value. • 1 = Loop-1 PV input is at or below the low deviation alarm value.
	1	Loop-2 Low Deviation Alarm — (set in word 19 of the configuration block) <ul style="list-style-type: none"> • 0 = Loop-2 PV input is above the low deviation alarm value. • 1 = Loop-2 PV input is at or below the low deviation alarm value.
	2	Loop-3 Low Deviation Alarm — (set in word 19 of the configuration block) <ul style="list-style-type: none"> • 0 = Loop-3 PV input is above the low deviation alarm value. • 1 = Loop-3 PV input is at or below the low deviation alarm value.
	3	Loop-4 Low Deviation Alarm — (set in word 19 of the configuration block) <ul style="list-style-type: none"> • 0 = Loop-4 PV input is above the low deviation alarm value. • 1 = Loop-4 PV input is at or below the low deviation alarm value.
	4	Loop-5 Low Deviation Alarm — (set in word 19 of the configuration block) <ul style="list-style-type: none"> • 0 = Loop-5 PV input is above the low deviation alarm value. • 1 = Loop-5 PV input is at or below the low deviation alarm value.
	5	Loop-6 Low Deviation Alarm — (set in word 19 of the configuration block) <ul style="list-style-type: none"> • 0 = Loop-6 PV input is above the low deviation alarm value. • 1 = Loop-6 PV input is at or below the low deviation alarm value.

Word	Bits	Description
62	6	Loop-7 Low Deviation Alarm — (set in word 19 of the configuration block) <ul style="list-style-type: none"> • 0 = Loop-7 PV input is above the low deviation alarm value. • 1 = Loop-7 PV input is at or below the low deviation alarm value.
	7	Loop-8 Low Deviation Alarm — (set in word 19 of the configuration block) <ul style="list-style-type: none"> • 0 = Loop-8 PV input is above the low deviation alarm value. • 1 = Loop-8 PV input is at or below the low deviation alarm value.
	8	Loop-1 High Deviation Alarm — (set in word 20 of the configuration block) <ul style="list-style-type: none"> • 0 = Loop-1 PV input is below the high deviation alarm value. • 1 = Loop-1 PV input is at or above the high deviation alarm value.
	9	Loop-2 High Deviation Alarm — (set in word 20 of the configuration block) <ul style="list-style-type: none"> • 0 = Loop-2 PV input is below the high deviation alarm value. • 1 = Loop-2 PV input is at or above the high deviation alarm value.
	10	Loop-3 High Deviation Alarm — (set in word 20 of the configuration block) <ul style="list-style-type: none"> • 0 = Loop-3 PV input is below the high deviation alarm value. • 1 = Loop-3 PV input is at or above the high deviation alarm value.
	11	Loop-4 High Deviation Alarm — (set in word 20 of the configuration block) <ul style="list-style-type: none"> • 0 = Loop-4 PV input is below the high deviation alarm value. • 1 = Loop-4 PV input is at or above the high deviation alarm value.
	12	Loop-5 High Deviation Alarm — (set in word 20 of the configuration block) <ul style="list-style-type: none"> • 0 = Loop-5 PV input is below the high deviation alarm value. • 1 = Loop-5 PV input is at or above the high deviation alarm value.
	13	Loop-6 High Deviation Alarm — (set in word 20 of the configuration block) <ul style="list-style-type: none"> • 0 = Loop-6 PV input is below the high deviation alarm value. • 1 = Loop-6 PV input is at or above the high deviation alarm value.
	14	Loop-7 High Deviation Alarm — (set in word 20 of the configuration block) <ul style="list-style-type: none"> • 0 = Loop-7 PV input is below the high deviation alarm value. • 1 = Loop-7 PV input is at or above the high deviation alarm value.
15	Loop-8 High Deviation Alarm — (set in word 20 of the configuration block) <ul style="list-style-type: none"> • 0 = Loop-8 PV input is below the high deviation alarm value. • 1 = Loop-8 PV input is at or above the high deviation alarm value. 	

Word	Bits	Description
63	0	Loop-1 Auto-Tuning successful <ul style="list-style-type: none"> • 0 = Auto-tuning was not successful for loop-1 • 1 = Auto-tuning was successful in determining PID gains for loop-1.
	1	Loop-2 Auto-Tuning successful <ul style="list-style-type: none"> • 0 = Auto-tuning was not successful for loop-2 • 1 = Auto-tuning was successful in determining PID gains for loop-2.
	2	Loop-3 Auto-Tuning successful <ul style="list-style-type: none"> • 0 = Auto-tuning was not successful for loop-3 • 1 = Auto-tuning was successful in determining PID gains for loop-3.
	3	Loop-4 Auto-Tuning successful <ul style="list-style-type: none"> • 0 = Auto-tuning was not successful for loop-4 • 1 = Auto-tuning was successful in determining PID gains for loop-4.
	4	Loop-5 Auto-Tuning successful <ul style="list-style-type: none"> • 0 = Auto-tuning was not successful for loop-5 • 1 = Auto-tuning was successful in determining PID gains for loop-5.
	5	Loop-6 Auto-Tuning successful <ul style="list-style-type: none"> • 0 = Auto-tuning was not successful for loop-6 • 1 = Auto-tuning was successful in determining PID gains for loop-6.
	6	Loop-7 Auto-Tuning successful <ul style="list-style-type: none"> • 0 = Auto-tuning was not successful for loop-7 • 1 = Auto-tuning was successful in determining PID gains for loop-7.
	7	Loop-8 Auto-Tuning successful <ul style="list-style-type: none"> • 0 = Auto-tuning was not successful for loop-8 • 1 = Auto-tuning was successful in determining PID gains for loop-8.
	8-15	Reserved.
64	0-7	Firmware Revision — In ASCII. (A thru Z)
	8-15	Firmware Series — In ASCII. (A thru Z)

- Words 1 thru 64 of the system status block are identified by the mnemonics TMS01 thru TMS64 in ProSet 700 software.

What to do next

To learn how to calibrate the temperature control module, read chapter 8.

Calibrating the Module

Chapter Objective

In this chapter, for calibrating your module, we describe:

- tools and equipment
- when to calibrate
- calibration methods
- indicator operation during calibration
- preparing to calibrate
- write calibration block
- read calibration block
- calibration procedure

Tools and Equipment

In order to calibrate your temperature control module you will need the following tools and equipment:

Tool or Equipment	Description
Precision Voltage Source	0–10V, 1 μ V resolution
Precision Multimeter	10V, 1 μ V resolution
Industrial Terminal and Interconnect Cable	Programming terminal for PLC processors

When to Calibrate

The temperature control module is shipped factory calibrated. We recommend that the module be recalibrated after the first 6 months. After the first recalibration, we recommend recalibration after each 12-month interval.

Indicator Operation During Calibration

During calibration, the RUN/FLT indicator will turn to green; the CAL/COM indicator will turn to flashing red. The indicators will remain with these indications throughout the calibration procedure.

Preparing to Calibrate

If need to recalibrate the module, you must calibrate the module in an I/O chassis. The module must communicate with the PLC processor and an industrial terminal (or compatible personal computer). Before calibrating the module, you must enter ladder logic into the processor memory, so that it can send (block-transfer write) calibration data to the module, and access (block-transfer read) calibration data from the module.

Calibration Write Block

The calibration write block contains 20 words as shown in Table 6.A.

Table 6.A
Calibration Write Block

Word	Bits	Description
1	0-15	Block Identification Code — 1100 1100 0000 0000 (CC00 ₁₆)
2	0	Calibration High/Low <ul style="list-style-type: none"> • 0 = Low • 1 = High
	1	Calibration Clock — 1-to-0 transition triggers calibration functions
	2-15	Always = 0
3	0-7	Input Calibration Mask — Bits 0 thru 7 respectively correspond to loops 1 thru 8 respectively.
	8-15	Always = 0
4	0-15	Always = 0
5	0-15	Always = 0
6	0-15	Always = 0
7	0-15	Always = 0
8	0-15	Always = 0
9	0-15	Always = 0
10	0-15	Always = 0
11	0-15	Always = 0
12	0-15	Always = 0
13	0-15	Always = 0
14	0-15	Always = 0
15	0-15	Always = 0
16	0-15	Always = 0
17	0-15	Always = 0
18	0-15	Always = 0
19	0-15	Always = 0
20	0-15	Always = 0

Calibration Read Block

The calibration read block contains 14 words as shown in Table 6.B.

Table 6.B
Calibration Read Block

Word	Bits	Description
1	0–15	Block Identification Code — 1100 0000 0000 0000 (C000 ₁₆)
2	0	Bad Calibration Procedure <ul style="list-style-type: none"> • 0 = OK • 1 = Wrong calibration procedure was attempted with the calibration write block.
	1	Calibration Hardware Failure <ul style="list-style-type: none"> • 0 = OK • 1 = Calibration cannot take place due to hardware failure.
	2	Calibration Reference Out of Range <ul style="list-style-type: none"> • 0 = OK • 1 = Incorrect reference signal was used during calibration.
	3–15	Reserved
3	0	Loop-1 Input Calibration Done
	1	Loop-2 Input Calibration Done
	2	Loop-3 Input Calibration Done
	3	Loop-4 Input Calibration Done
	4	Loop-5 Input Calibration Done
	5	Loop-6 Input Calibration Done
	6	Loop-7 Input Calibration Done
	7	Loop-8 Input Calibration Done
8–15	Reserved	
4	0–15	Reserved

Word	Bits	Description
5	0	Loop-1 Input Calibration Bad
	1	Loop-2 Input Calibration Bad
	2	Loop-3 Input Calibration Bad
	3	Loop-4 Input Calibration Bad
	4	Loop-5 Input Calibration Bad
	5	Loop-6 Input Calibration Bad
	6	Loop-7 Input Calibration Bad
	7	Loop-8 Input Calibration Bad
	8-15	Reserved
6	0-15	Reserved
7	0-15	Reserved
8	0-15	Reserved
9	0-15	Reserved
10	0-15	Reserved
11	0-15	Reserved
12	0-15	Reserved
13	0-15	Reserved
14	0-15	Reserved

Calibration Procedure

You can calibrate any number of loop input channels, in any order. Set up a calibration write block as shown in Table 6.A.

Important: In order to allow the module to stabilize, energize the module for at least 30 minutes before calibrating.

1. In the input calibration mask (word 2) of the calibration write block, turn each bit corresponding to each loop you want to calibrate. Refer to Table 6.A.
2. Apply the appropriate low reference signal (Table 6.C) to the input of each loop being calibrated (for loop 1, I1 on RTP).

Table 6.C
Calibration Reference Signal Values

Type	Low Reference Value	High Reference Value
100mV/TC input	0.000mV	100.000mV

3. In the calibration write block
 - a. turn off the calibration high/low bit (word 2, bit 0)
 - b. turn on the calibration clock bit (word 2, bit 1)
4. Send (block-transfer write) the calibration write block to the module.
5. In the calibration write block
 - a. turn off the calibration high/low bit (word 2, bit 0)
 - b. turn off the calibration clock bit (word 2, bit 1)
6. Send (block-transfer write) the calibration write block to the module.
7. Apply the appropriate high reference signal (Table 6.C) to the input of each loop being calibrated (for loop 1, I1 on RTP)
8. In the calibration write block
 - a. turn on the calibration high/low bit (word 2, bit 0)
 - b. turn on the calibration clock bit (word 2, bit 1)
9. Send (block-transfer write) the calibration write block to the module.

10. In the calibration write block
 - a. turn on the calibration high/low bit (word 2, bit 0)
 - b. turn off the calibration clock bit (word 2, bit 1)
11. Send (block-transfer write) the calibration write block to the module.
12. Request (block-transfer read) the calibration read block from the module. If the input-calibration-bad bit in word 5 is off, and the corresponding input-calibration-done bit in word 3 is on, the procedure is complete for the corresponding loop.

If the bad-calibration-procedure bit (word 2, bit 0) is on any time during the calibration procedure, an error occurred during the calibration procedure. Repeat the calibration.

If the calibration hardware fault bit (word 2, bit 01) is on, the module has a hardware fault. The module cannot be calibrated.

If the calibration reference out-of-range bit (word 2, bit 2) is on, the input(s) did not calibrate because one of the reference signals was out of range. Repeat the procedure. If this bit goes on a second time, either the loop is bad, or there is a problem with the calibration equipment.

What to do next

To learn how to troubleshoot the temperature control module, read chapter 9.

Troubleshooting

Chapter Objective

We describe how to troubleshoot your module by observing LED indicators.

Diagnostics Reported by the Module

At power-up, the module turns the RUN/FLT indicator to red, then checks for:

- correct RAM operation
- EPROM operation
- EEPROM operation

After passing initial diagnostics, the module turns the RUN/FLT indicator to flashing green. The indicator will continue to flash green until it receives a valid block-transfer write. After the block-transfer write, it will stay solid green during normal operation. It will turn red if it detects a fault condition. If the RUN/FLT indicator is red, block-transfers will be inhibited.

The lower CAL/COM indicator flashes green when the module is communicating with the processor. The speed of the flashing is dependent upon system speed.

Figure 7.1
Indicators

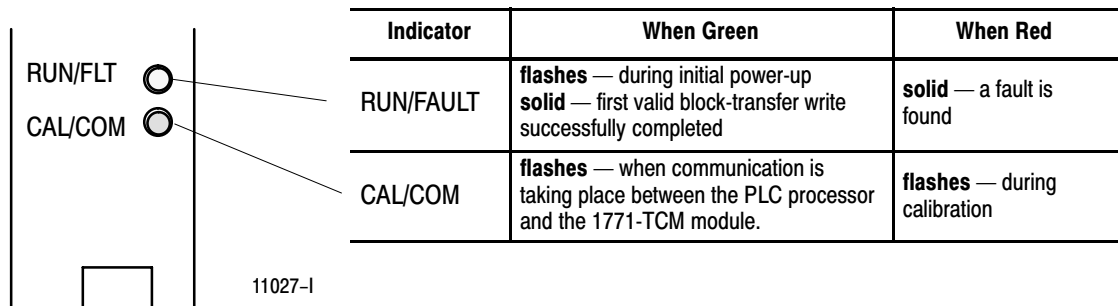

Troubleshooting with the Indicators

Table 7.A shows indications, probable causes and recommended actions to correct common faults which may occur.

Table 7.A
Troubleshooting Chart

Indication	Probable Cause	Recommended Action
Both indicators are OFF	No power to module	Check power to I/O chassis. Recycle as necessary.
	Possible short on the module LED driver failure	Replace module.
RUN/FLT indicator ON red	Microprocessor, oscillator or EPROM failure	Replace module.
	If immediately after power-up, indicates RAM or EPROM failure.	Replace module.
	If during operation, indicates possible microprocessor or backplane interface failure.	Replace module.
RUN/FLT indicator is flashing green	Power-up diagnostics successfully completed.	Normal operation.
RUN/FLT indicator is solid green	Initial block-transfer write successfully completed	Normal operation.
CAL/COM indicator is green (solid or flashing)	Normal operation	None required
CAL/COM indicator is green and RUN/FLT indicator is green but module data is wrong (for example, with cable off, input channel data values are at minimum scale values)	Internal fuse may be bad	Replace module

Status Reported by the Module

The module also reports status and specific faults (if they occur) in every block-transfer of status data to the processor. Monitor the green/red LED indicators and status bits in the appropriate word of the system status block when troubleshooting your module.

Design your program to monitor module and channel status bits, and to take appropriate action, depending on your application requirements. You may also want to monitor these bits while troubleshooting with your industrial terminal.

In the system status block, two words for each loop provide you with status codes if you enter a value out of range or bit selections that conflict with each other in any of the blocks transferred to the module. These codes and their meanings are listed in appendix B to help you locate these errors.



Specifications

General Specifications

Number of PID Loops	8 individually isolated
I/O Chassis Location	any single I/O module slot
A/D Resolution	16 bits or 15 bits plus sign bit
Input Filtering	6-pole low-pass hardware filter
Calibration Interval	<ul style="list-style-type: none"> • 6 months for first interval • 1 year for subsequent intervals
Isolation Voltage	Designed to withstand 1000V dc continuous between input channels and between input and backplane connections. Modules are 100% tested at 1200V dc for 1 second between input channels and backplane connections.
Max Backplane Current Load	1.0A
Environmental Conditions <ul style="list-style-type: none"> • Operating Temperature • Rate of Change • Storage Temperature • Relative Humidity 	<ul style="list-style-type: none"> • 0 to 60°C (32 to 140°F) • Ambient changes greater than 0.5°C/minute may temporarily degrade performance during periods of change. • -40 to 85°C (-40 to 185°F) • 5 to 95% (without condensation)
Connecting Cable(s)	1771-NC6 = 1.8m (6 ft) 1771-NC15 = 4.6m (15 ft)
Keying	Between 26 and 28 Between 32 and 34

Temperature Specifications

Input Range (selectable)	±105mV Type B: 300 to 1800°C (572 to 3272°F) Type E: -270 to 1000°C (-454 to 1832°F) Type J: -210 to 1200°C (-346 to 2192°F) Type K: -270 to 1372°C (-454 to 2502°F) Type R: -50 to 1768°C (-58 to 3214°F) Type S: -50 to 1768°C (-58 to 3214°F) Type T: -270 to 400°C (-454 to 752°F)
Maximum Input Resolution ¹	3.3μV/bit @ 15 bits with sign bit Type E, J, K, T 0.1°C (0.2°F) ² Type B, R, S: 0.3°C (0.6°F) ²
Default Display Resolution	0.1°C (0.1°F)
Temperature Scale	°C (°F)
Input Impedance	> 10 MΩ
Thermocouple Linearization	IPTS-68 standard, NBS MN-125
Cold Junction Compensation	0 to 70°C ±0.25°C
Open Input Detection	upscale
Open TC Leakage Current	< 10 nA (maximum)
Time to Detect Open Input	5s (maximum)
Input Overvoltage Protection	140V ac rms continuous
Normal Mode Rejection (50/60Hz)	50dB / 60dB (minimum)
Common Mode Rejection (60Hz)	150dB (typical)
Offset Drift (maximum)	±0.50μV/°C
Gain Drift (maximum)	±35ppm/°C
Input Bandwidth	9Hz
Update Time (8 loops)	1s
TPO Update Time (block-transfer)	500ms (maximum)
TPO Update Time (single-transfer)	20ms (maximum)
Settling Time to within 0.1% of Full Scale	125ms (maximum)
Non-linearity	0.02% of full range (maximum)
Accuracy with Calibration (includes non-linearity, gain, offset)	0.01% of full range @ 25°C (typical) 0.05% of full range @ 25°C (maximum)
Calibration Values	0.000 / 100.000mV
Underrange Threshold	-103.0mV
Overrange Threshold	+103.0mV
Rate Alarm Value Minimum (0.04% FSR) Maximum (50% FSR)	0.08mV / 0.9°C (1.6°F) per second 100mV / 1050°C (1890°F) per second
Scaling Points → Default Scaling Values	-100/+100mV → -100.00/+100.00 -300/+1800°C → -300.0/1800.0 -508/+3272°F → -508.0/3272.0

¹ Maximum resolution is obtained by rescaling input data to counts.

² These resolutions apply to the commonly used ranges for these thermocouples. See graphs.

Temperature Resolution of Thermocouple Inputs

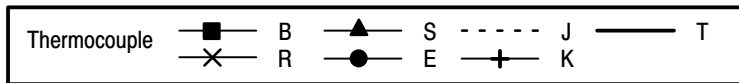
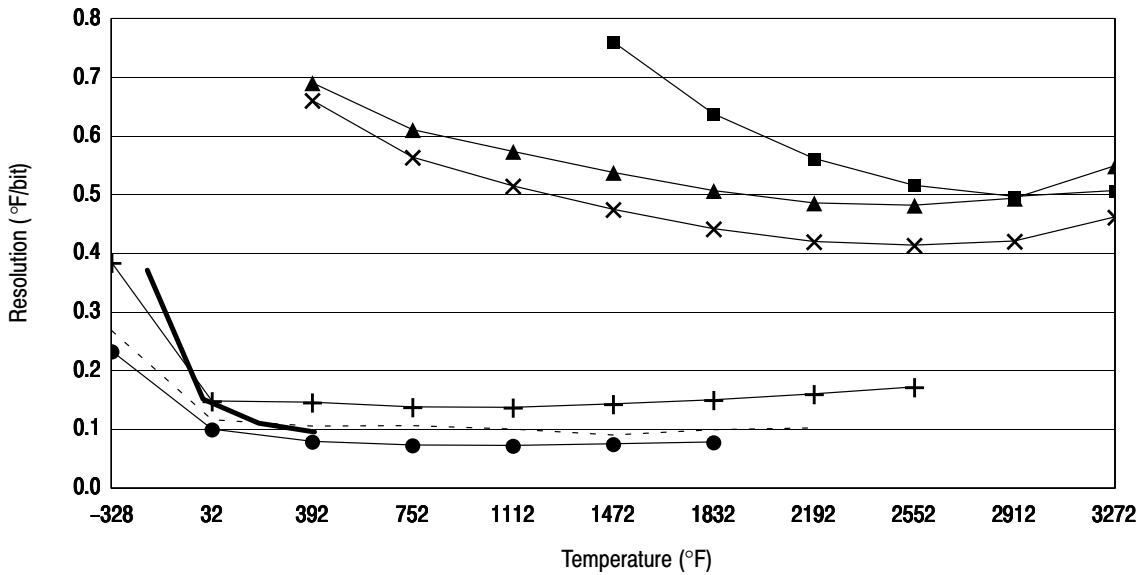
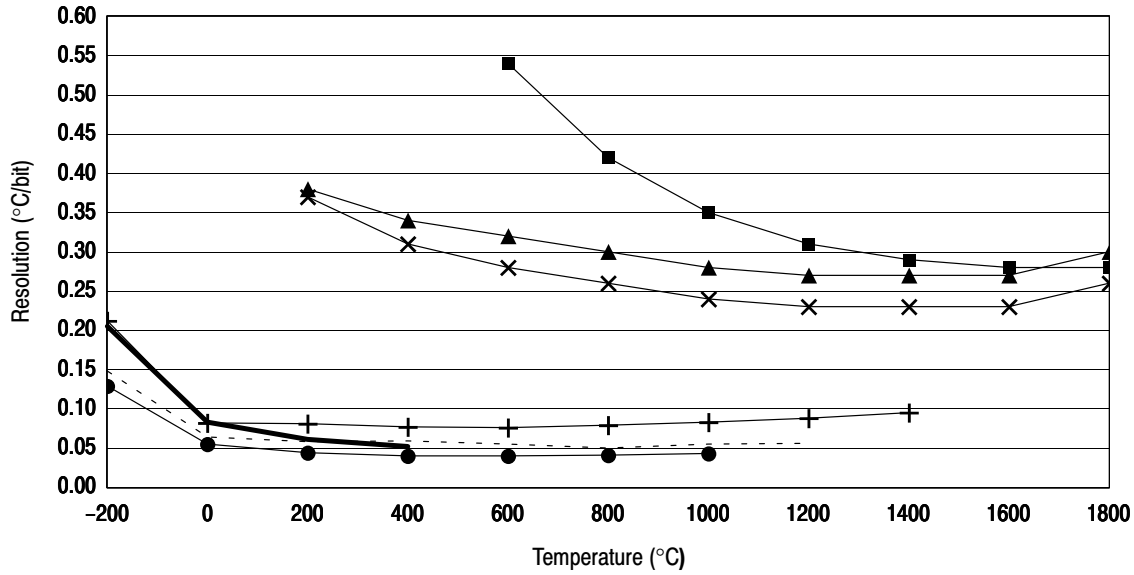

Locating Errors

In the status file, 2 words per loop provide error codes for their corresponding loop. The first word for each loop indicates configuration-block and gains-block errors for that loop.

Display of integer value in word 3, 6, 9, 12, 15, 18, 21, or 24 of the status block



A non-zero value in these two digits indicate an error in the **gains block**

A non-zero value in these two digits indicate an error in the **configuration block**

Example: If a value 4713 is displayed, the 47 in the upper pair of digits would indicate an error in the **gains block** and the 13 in the least-significant pair of digits would indicate an error in the **configuration block**

If This Word of Status Block:	Contains This Value:	The Error is:
3 (loop 1) 6 (loop 2) 9 (loop 3) 12 (loop 4) 15 (loop 5) 18 (loop 6) 21 (loop 7) 24 (loop 8)	xx00	No error detected in configuration block.
	xx01 thru xx23	A word in the configuration block has an out-of-range value or incompatible bit selection. Locate the specific word by the value in the 2 least-significant decimal digits of the status word. (value = word) <ul style="list-style-type: none"> Example: If the value in word 6 is xx14, word 14 (cool maximum cycle time) of the loop-2 configuration block has an out-of-range value,
	00xx	No error detected in gains block.
	1xx thru 57xx	A word in the gains block has an out-of-range value. Locate the specific word by the value in the 3rd and 4th least-significant decimal digits of the status word. (value = word) <ul style="list-style-type: none"> Example: If the value in word 9 is 14xx, word 14 (loop-2 cool derivative gain) of the gains block has an out-of-range value,

Appendix B Locating Errors

The second word for each loop indicates dynamic-block and auto-tuning errors for that loop.

Display of integer value in word 4,
7, 10, 13, 16, 19, 22, or 25 of the
status block

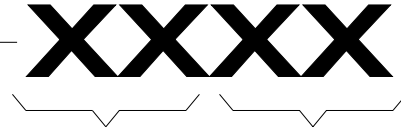

A non-zero value in
these two digits
indicate an error in the
auto-tuning process

A non-zero value in
these two digits
indicate an error in the
dynamic block

Example: If a value 6724 is displayed, the 67 in the upper pair of digits would indicate an error in auto-tuning and the 24 in the least-significant pair of digits would indicate an error in the **dynamic block**

If This Word of Status Block:	Contains This Value:	The Error is:
4 (loop 1) 7 (loop 2) 10 (loop 3) 13 (loop 4) 16 (loop 5) 19 (loop 6) 22 (loop 7) 25 (loop 8)	xx00	No error detected in dynamic block.
	xx01 thru xx34	A word in the dynamic block has an out-of-range value or incompatible bit selection. Locate the specific word by the value in the 2 least-significant decimal digits of the status word. (value = word) <ul style="list-style-type: none"> Example: If the value in word 13 is xx17, word 17 (loop-4 manual output value) of the dynamic block has an out-of-range value,
	00xx	No error in auto-tuning the loop.
	65xx	Auto-tuning terminated because of thermal runaway.
	66xx	Auto-tuning terminated because the change in PV (since initial PV temperature) has exceeded 200°.
	67xx	Auto-tuning terminated because PV is within 50° of set-point.

Specifications

General Specifications

Number of PID Loops	8 individually isolated
I/O Chassis Location	any single I/O module slot
A/D Resolution	16 bits or 15 bits plus sign bit
Input Filtering	6-pole low-pass hardware filter
Calibration Interval	<ul style="list-style-type: none"> • 6 months for first interval • 1 year for subsequent intervals
Isolation Voltage	Designed to withstand 1000V dc continuous between input channels and between input and backplane connections. Modules are 100% tested at 1200V dc for 1 second between input channels and backplane connections.
Max Backplane Current Load	1.0A
Environmental Conditions <ul style="list-style-type: none"> • Operating Temperature • Rate of Change • Storage Temperature • Relative Humidity 	<ul style="list-style-type: none"> • 0 to 60°C (32 to 140°F) • Ambient changes greater than 0.5°C/minute may temporarily degrade performance during periods of change. • -40 to 85°C (-40 to 185°F) • 5 to 95% (without condensation)
Connecting Cable(s)	1771-NC6 = 1.8m (6 ft) 1771-NC15 = 4.6m (15 ft)
Keying	Between 26 and 28 Between 32 and 34

Temperature Specifications

Input Range (selectable)	±105mV Type B: 300 to 1800°C (572 to 3272°F) Type E: -270 to 1000°C (-454 to 1832°F) Type J: -210 to 1200°C (-346 to 2192°F) Type K: -270 to 1372°C (-454 to 2502°F) Type R: -50 to 1768°C (-58 to 3214°F) Type S: -50 to 1768°C (-58 to 3214°F) Type T: -270 to 400°C (-454 to 752°F)
Maximum Input Resolution ¹	3.3µV/bit @ 15 bits with sign bit Type E, J, K, T 0.1°C (0.2°F) ² Type B, R, S: 0.3°C (0.6°F) ²
Default Display Resolution	0.1°C (0.1°F)
Temperature Scale	°C (°F)
Input Impedance	> 10 MΩ
Thermocouple Linearization	IPTS-68 standard, NBS MN-125
Cold Junction Compensation	0 to 70°C ±0.25°C
Open Input Detection	upscale
Open TC Leakage Current	< 10 nA (maximum)
Time to Detect Open Input	5s (maximum)
Input Overvoltage Protection	140V ac rms continuous
Normal Mode Rejection (50/60Hz)	50dB / 60dB (minimum)
Common Mode Rejection (60Hz)	150dB (typical)
Offset Drift (maximum)	±0.50µV/°C
Gain Drift (maximum)	±35ppm/°C
Input Bandwidth	9Hz
Update Time (8 loops)	1s
TPO Update Time (block-transfer)	500ms (maximum)
TPO Update Time (single-transfer)	20ms (maximum)
Settling Time to within 0.1% of Full Scale	125ms (maximum)
Non-linearity	0.02% of full range (maximum)
Accuracy with Calibration (includes non-linearity, gain, offset)	0.01% of full range @ 25°C (typical) 0.05% of full range @ 25°C (maximum)
Calibration Values	0.000 / 100.000mV
Underrange Threshold	-103.0mV
Overrange Threshold	+103.0mV
Rate Alarm Value Minimum (0.04% FSR) Maximum (50% FSR)	0.08mV / 0.9°C (1.6°F) per second 100mV / 1050°C (1890°F) per second
Scaling Points → Default Scaling Values	-100/+100mV → -100.00/+100.00 -300/+1800°C → -300.0/1800.0 -508/+3272°F → -508.0/3272.0

¹ Maximum resolution is obtained by rescaling input data to counts.

² These resolutions apply to the commonly used ranges for these thermocouples. See graphs.

Temperature Resolution of Thermocouple Inputs

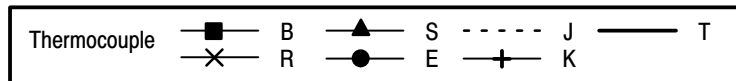
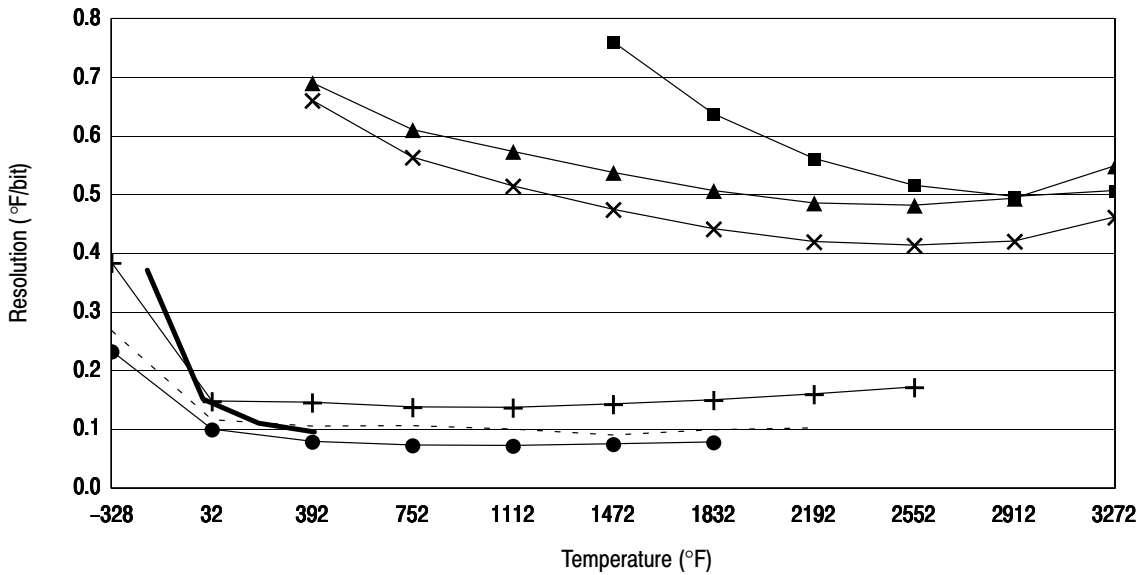
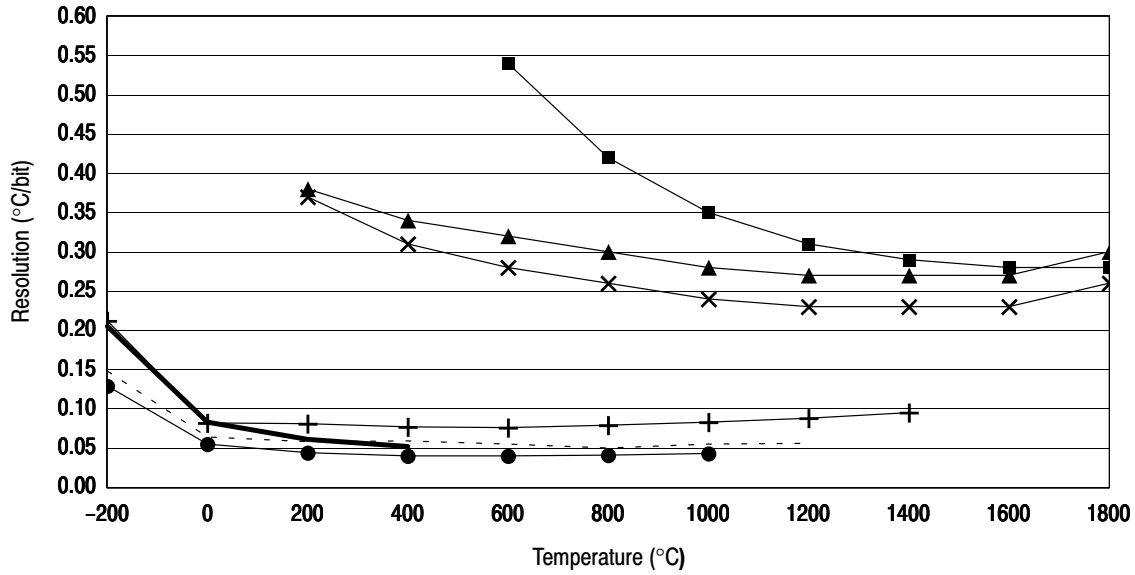

Locating Errors

In the status file, 2 words per loop provide error codes for their corresponding loop. The first word for each loop indicates configuration-block and gains-block errors for that loop.

Display of integer value in word ,
, , , , , , or of the
status block



A non-zero value in these two digits indicate an error in the **gains block**

A non-zero value in these two digits indicate an error in the **configuration block**

Example: If a value 4713 is displayed, the 47 in the upper pair of digits would indicate an error in the **gains block** and the 13 in the least-significant pair of digits would indicate an error in the **configuration block**

If This Word of Status Block:	Contains This Value:	The Error is:
(loop 1) (loop 2) (loop 3) (loop 4) (loop 5) (loop 6) (loop 7) (loop 8)	xx00	No error detected in configuration block.
	xx01 thru xx23	A word in the configuration block has an out-of-range value or incompatible bit selection. Locate the specific word by the value in the 2 least-significant decimal digits of the status word. (value = word) <ul style="list-style-type: none"> Example: If the value in word is xx14, word (cool maximum cycle time) of the loop-2 configuration block has an out-of-range value,
	00xx	No error detected in gains block.
	1xx thru 57xx	A word in the gains block has an out-of-range value. Locate the specific word by the value in the 3rd and 4th least-significant decimal digits of the status word. (value = word) <ul style="list-style-type: none"> Example: If the value in word is 14xx, word (loop-2 cool derivative gain) of the gains block has an out-of-range value,

6 9 12 15 18 21 24 3

3
6
9
12
15
18
21
24

6 14

9 14

AB Parts

Appendix B Locating Errors

The second word for each loop indicates dynamic-block and auto-tuning errors for that loop.

Display of integer value in word 4,
7, 10, 13, 16, 19, 22, or 25 of the
status block

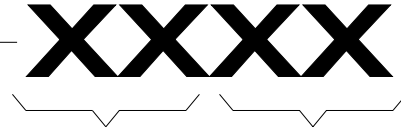

A non-zero value in
these two digits
indicate an error in the
auto-tuning process

A non-zero value in
these two digits
indicate an error in the
dynamic block

Example: If a value 6724 is displayed, the 67 in the upper pair of digits would indicate an error in auto-tuning and the 24 in the least-significant pair of digits would indicate an error in the **dynamic block**

If This Word of Status Block:	Contains This Value:	The Error is:
4 (loop 1) 7 (loop 2) 10 (loop 3) 13 (loop 4) 16 (loop 5) 19 (loop 6) 22 (loop 7) 25 (loop 8)	xx00	No error detected in dynamic block.
	xx01 thru xx34	A word in the dynamic block has an out-of-range value or incompatible bit selection. Locate the specific word by the value in the 2 least-significant decimal digits of the status word. (value = word) <ul style="list-style-type: none"> Example: If the value in word 13 is xx17, word 17 (loop-4 manual output value) of the dynamic block has an out-of-range value,
	00xx	No error in auto-tuning the loop.
	65xx	Auto-tuning terminated because of thermal runaway.
	66xx	Auto-tuning terminated because the change in PV (since initial PV temperature) has exceeded 200°.
	67xx	Auto-tuning terminated because PV is within 50° of set-point.

Example Ladder Logic Program

Appendix Objectives

This appendix describes a ladder logic program. This program is for a PLC-5 processor. You can use this program to test the module. Also, by using this program as a model, you can save time in developing a program for your application.

Abbreviations

In this appendix, we use the following abbreviations.

Abbreviation	Meaning
L1C	Loop-1 configuration block
L2C	Loop-2 configuration block
L3C	Loop-3 configuration block
L4C	Loop-4 configuration block
L5C	Loop-5 configuration block
L6C	Loop-6 configuration block
L7C	Loop-7 configuration block
L8C	Loop-8 configuration block
GBC	Gains block
DYC	Dynamic block
SYS	System status block
BTR	Block-Transfer Read
BTW	Block-Transfer Write
TCM	Temperature Control Module
TPO	Time-proportioned Output(s)

Program Files

This program uses the following program files.

Program File	Use
2	Main program file
4	TPO bits from I/O
30	Subroutine to execute block-transfer read from TCM
32	Subroutine to service complete block-transfer read from TCM
33	Subroutine to check for required upholds from TCM
35	Subroutine to copy configuration files
40	Subroutine to service TCM block-transfer write functions
42	Subroutine to check for required download to TCM
43	Subroutine to load command block for TCM
44	Subroutine to execute block-transfer write to TCM
45	Subroutine to service complete block-transfer write to TCM

Program File 2

This program file handles the block-transfers to the TCM module. Program file 30 is called from this program file to execute a BTR from the TCM module every scan. Program file 40 is called from this program file to check whether the BTW is required to the TCM module.

Important: The ladder logic constantly checks the dynamic block for changes, and will automatically send it out if a change is made in the dynamic block.

Program File 4

This program file is the second main control program file. This file reads the input status from the TCM module and loads the heat and cool time-proportioned output (TPO) bits into B20:1.

Program File 35

This program file copies the configuration information from loop 1 into all 7 remaining loops when bit B21:5/15 is on.

Data Table Layout

This program requires the following data-table layout use in the TCM test ladder logic.

TPO Bit File

File	Word	Bit	Description
B20	0	0	Loop-1 Heat TPO Bit — Block-Transferred
		1	Loop-2 Heat TPO Bit — Block-Transferred
		2	Loop-3 Heat TPO Bit — Block-Transferred
		3	Loop-4 Heat TPO Bit — Block-Transferred
		4	Loop-5 Heat TPO Bit — Block-Transferred
		5	Loop-6 Heat TPO Bit — Block-Transferred
		6	Loop-7 Heat TPO Bit — Block-Transferred
		7	Loop-8 Heat TPO Bit — Block-Transferred
		8	Loop-1 Cool TPO Bit — Block-Transferred
		9	Loop-2 Cool TPO Bit — Block-Transferred
		10	Loop-3 Cool TPO Bit — Block-Transferred
		11	Loop-4 Cool TPO Bit — Block-Transferred
		12	Loop-5 Cool TPO Bit — Block-Transferred
		13	Loop-6 Cool TPO Bit — Block-Transferred
		14	Loop-7 Cool TPO Bit — Block-Transferred
	15	Loop-8 Cool TPO Bit — Block-Transferred	
	1	0	Loop-1 Heat TPO Bit — Single-Transferred
		1	Loop-2 Heat TPO Bit — Single-Transferred
		2	Loop-3 Heat TPO Bit — Single-Transferred
		3	Loop-4 Heat TPO Bit — Single-Transferred
		4	Loop-5 Heat TPO Bit — Single-Transferred
		5	Loop-6 Heat TPO Bit — Single-Transferred
		6	Loop-7 Heat TPO Bit — Single-Transferred
		7	Loop-8 Heat TPO Bit — Single-Transferred
		8	Loop-1 Cool TPO Bit — Single-Transferred
		9	Loop-2 Cool TPO Bit — Single-Transferred
		10	Loop-3 Cool TPO Bit — Single-Transferred
		11	Loop-4 Cool TPO Bit — Single-Transferred
		12	Loop-5 Cool TPO Bit — Single-Transferred
		13	Loop-6 Cool TPO Bit — Single-Transferred
14		Loop-7 Cool TPO Bit — Single-Transferred	
15	Loop-8 Cool TPO Bit — Single-Transferred		

Download Bits

File	Word	Bit	Description
B20	0	0	L1C download to TCM required
		1	L2C download to TCM required
		2	L3C download to TCM required
		3	L4C download to TCM required
		4	L5C download to TCM required
		5	L6C download to TCM required
		6	L7C download to TCM required
		7	L8C download to TCM required
		8	GBC download to TCM required
	9	DYC download to TCM required	
	1	0	L1C download to TCM in progress
		1	L8C download to TCM in progress
		2	L3C download to TCM in progress
		3	L4C download to TCM in progress
		4	L5C download to TCM in progress
		5	L6C download to TCM in progress
		6	L7C download to TCM in progress
		7	L8C download to TCM in progress
		8	GBC download to TCM in progress
9	DYC download to TCM in progress		
B26	0	0	L1C download to TCM at power-up or switch to run mode
		1	L2C download to TCM at power-up or switch to run mode
		2	L3C download to TCM at power-up or switch to run mode
		3	L4C download to TCM at power-up or switch to run mode
		4	L5C download to TCM at power-up or switch to run mode
		5	L6C download to TCM at power-up or switch to run mode
		6	L7C download to TCM at power-up or switch to run mode
		7	L8C download to TCM at power-up or switch to run mode
		8	GBC download to TCM at power-up or switch to run mode
9	DYC download to TCM at power-up or switch to run mode		

Word B26:0 is used by the program file 2 to set the needed download-required bits on power-up of the processor or when the processor is switched from program mode to run mode. If a configuration block-transfer is required while the processor is in the run mode, it requires additional ladder logic to be added to latch the appropriate download-required bit. The program will automatically unlatch the download-required bit after the successful block-transfer. Configuration blocks can also be downloaded by setting the download-required bit in the table from programming terminal.

Important: The ladder logic constantly checks the dynamic block for changes and will automatically send it out if a change is made in the dynamic block.

Miscellaneous Bits

File	Word	Bit	Description
B21	3	15	Copy configuration blocks

Data Blocks

File	Words	Description
B30	1-23	Loop-1 configuration block
B31	1-23	Loop-2 configuration block
B32	1-23	Loop-3 configuration block
B33	1-23	Loop-4 configuration block
B34	1-23	Loop-5 configuration block
B35	1-23	Loop-6 configuration block
B36	1-23	Loop-7 configuration block
B37	1-23	Loop-8 configuration block
B38	1-57	Gains block
B39	1-34	Dynamic block
B40	1-64	System status block

Ladder Logic Listing

The following is the listing of the ladder logic program. This program is for a 1785 PLC-5 processor. You can use this program to test the module. Also, by using this program as a model, you can save time in developing a program for your application.

```
+-----+
                Allen-Bradley Company
                6200 Series Software
                PLC-5 Programming Terminal Software
                Release 4.41
                Program Listing Report

                Processor File: TCM
                Wed Jun 1, 1994 - 2:55:14 pm

REPORT OPTIONS
Page Width:                80
Page Length:               66
Graphics Capabilities:    NO
Right Power Rail:         YES
Address Display:          ADDRESS
Address Comments:         YES
Rung Comments:            YES
Output Cross Reference:   NO
Ladder Cross Reference:   NONE
Starting Rung:             2:0
Ending Rung:               999:32767
+-----+
```

Appendix C
Example Ladder Logic Program

```

Program Listing Report                PLC-5/40    File TCM    Wed Jun 1, 1994    Page 16
                                           Rung 35:0

Rung 35:0
|
|                                     LOOP #2
|                                     CONFIG
|                                     BLOCK WORD
|                                     #2
|                                     +COP-----+
+-----+COPY FILE                    +-----+
|Source      #N30:2|
|Destination #N31:2|
|Length      63|
+-----+

Rung 35:1
|
|                                     LOOP #3
|                                     CONFIG
|                                     BLOCK WORD
|                                     #2
|                                     +COP-----+
+-----+COPY FILE                    +-----+
|Source      #N30:2|
|Destination #N32:2|
|Length      63|
+-----+

Rung 35:2
|
|                                     LOOP #4
|                                     CONFIG
|                                     BLOCK WORD
|                                     #2
|                                     +COP-----+
+-----+COPY FILE                    +-----+
|Source      #N30:2|
|Destination #N33:2|
|Length      63|
+-----+

Rung 35:3
|
|                                     LOOP #5
|                                     CONFIG
|                                     BLOCK WORD
|                                     #2
|                                     +COP-----+
+-----+COPY FILE                    +-----+
|Source      #N30:2|
|Destination #N34:2|
|Length      63|
+-----+

Rung 35:4
|
|                                     LOOP #6
|                                     CONFIG
|                                     BLOCK WORD
|                                     #2
|                                     +COP-----+
+-----+COPY FILE                    +-----+
|Source      #N30:2|
|Destination #N35:2|
|Length      63|
+-----+

```

Appendix C
Example Ladder Logic Program

```
Program Listing Report                PLC-5/40   File TCM   Wed Jun 1, 1994   Page 22
                                         Rung 42:15

Rung 42:15
| CHANGE FND
| DURING
| TCM DYC
| WORD FILE
| SEARCH
| R23:0
+-----] [-----] (L)-----+
|          FD
|                                     9
Rung 42:16
| CHANGE FND
| DURING
| TCM DYC
| WORD FILE
| SEARCH
| R23:0
+-----] [-----] (L)-----+
|          FD
|                                     31
Rung 42:17
|
+-----] [-----] [END OF FILE]-----+
|
```

Appendix C
Example Ladder Logic Program

```

Program Listing Report                PLC-5/40    File TCM                Wed Jun 1, 1994    Page 24
                                        Rung 43:6
Rung 43:6
|
|                                     L2C
|                                     DOWNLOAD
|                                     TO TCM
|                                     IN PROGRES
|                                     B21
|------(L)-----+
|
Rung 43:7
|
|                                     +RET-----+
|-----+RETURN ( )-----+
|
|                                     |Return parameter|
|-----+-----+
Rung 43:8
|
|   L2C |                                     L3C
|   DOWNLOAD |   L3C   |   DOWNLOAD
|   TO TCM   |   TO TCM |   TO TCM
|   NOT      |   TO TCM |   NOT
|   REQUIRED  |   REQUIRED |   REQUIRED
|   1        |   B21    |   2
|-----[LBL]-----]/[------(JMP)-----+
|
|                                     2
Rung 43:9
|
|                                     ( DATA )
|                                     (TO TCM )
|                                     BTW DATA
|                                     FILE
|                                     WORD #01
|
|                                     +COP-----+
|-----+COPY FILE-----+
|
|                                     |Source      #N32:1|
|                                     |Destination #B24:74|
|                                     |Length      64 |
|-----+-----+
Rung 43:10
|
|                                     L3C
|                                     DOWNLOAD
|                                     TO TCM
|                                     IN PROGRES
|                                     B21
|------(L)-----+
|
Rung 43:11
|
|                                     +RET-----+
|-----+RETURN ( )-----+
|
|                                     |Return parameter|
|-----+-----+
Rung 43:12
|
|   L3C |                                     L4C
|   DOWNLOAD |   L4C   |   DOWNLOAD
|   TO TCM   |   TO TCM |   TO TCM
|   NOT      |   TO TCM |   NOT
|   REQUIRED  |   REQUIRED |   REQUIRED
|   2        |   B21    |   3
|-----[LBL]-----]/[------(JMP)-----+
|
|                                     3

```

Appendix C
Example Ladder Logic Program

```

Program Listing Report                               PLC-5/40   File TCM   Wed Jun 1, 1994   Page 26
                                                    Rung 43:19

Rung 43:19
|
|                                                     +RET-----+
+-----+-----+-----+-----+-----+-----+
|                                                     |RETURN ( )   |
|                                                     |Return parameter|
+-----+-----+-----+-----+-----+-----+

Rung 43:20
|
|   L5C | | L6C | | L6C |
| DOWNLOAD | | DOWNLOAD | | DOWNLOAD |
| TO TCM | | TO TCM | | TO TCM |
| NOT | | TO TCM | | NOT |
| REQUIRED | | REQUIRED | | REQUIRED |
| 4 | | B21 | | 5 |
+---[LBL]---] / [-----] (JMP)-----+
|
|                                     5
Rung 43:21
|
|                                     ( DATA )
|                                     (TO TCM )
|                                     BTW DATA
|                                     FILE
|                                     WORD #01
|
|                                     +COP-----+
+-----+-----+-----+-----+-----+
|                                     |COPY FILE   |
|                                     |Source      #N35:1|
|                                     |Destination #B24:74|
|                                     |Length      64 |
+-----+-----+-----+-----+-----+

Rung 43:22
|
|                                     L6C
|                                     DOWNLOAD
|                                     TO TCM
|                                     IN PROGRES
|                                     B21
+-----+-----+-----+-----+-----+
|                                     (L)
|                                     21
Rung 43:23
|
|                                                     +RET-----+
+-----+-----+-----+-----+-----+
|                                                     |RETURN ( )   |
|                                                     |Return parameter|
+-----+-----+-----+-----+-----+

Rung 43:24
|
|   L6C | | L7C | | L7C |
| DOWNLOAD | | DOWNLOAD | | DOWNLOAD |
| TO TCM | | TO TCM | | TO TCM |
| NOT | | TO TCM | | NOT |
| REQUIRED | | REQUIRED | | REQUIRED |
| 5 | | B21 | | 6 |
+---[LBL]---] / [-----] (JMP)-----+
|
|                                     6

```

Appendix C
Example Ladder Logic Program

```

Program Listing Report          PLC-5/40   File TCM   Wed Jun 1, 1994   Page 29
                                      Rung 43:37
Rung 43:37
|                                     ( DATA )
|                                     (TO TCM )
|                                     BTW DATA
|                                     FILE
|                                     WORD #01
|                                     +COP-----+
+-----+COPY FILE+-----+
|Source      #N39:1|
|Destination #B24:74|
|Length      64|
+-----+
Rung 43:38
|                                     DYC
|                                     DOWNLOAD
|                                     TO TCM
|                                     IN PROGRES
|                                     B21
|                                     (L)-----+
|                                     25
Rung 43:39
| DYC
| DOWNLOAD
| TO TCM
| NOT
| REQUIRED
| 9
| [LBL]-----+RET-----+
+-----+RETURN ( )+-----+
|Return parameter|
+-----+
Rung 43:40
+-----[END OF FILE]-----+

```

Saving Auto-Tuning Parameter Values

Appendix Objectives

This appendix shows you how auto-tuning parameter values are saved by reading the auto-tuning status block from and writing the auto-tuning command block to the 1771-TCM module.

Sequence of Block-Transfers

Once auto-tuning is complete, the auto-tuning status block must be read (block-transferred) from the module to store it in PLC processor memory. The module's memory is volatile. Whenever power to the module is interrupted, the auto-tuning command block must again be sent to it.

The ProSet 700 software handles the block-transfer of these auto-tuning parameter values transparently so that you do not need to program these block-transfers, and you have no need to know anything about any of these values. However, we show you the structure of these blocks just to let you know what is happening.

Appendix D

Saving Auto-Tuning Parameter Values

Auto-Tuning Status/Command Block

The auto-tuning status block and auto-tuning command block each contains 57 words as follows:

Word	Bits	Description
1	0-15	Block Identification Code
2	0-15	Loop-1 Auto-Tuning Parameter Value #1
3	0-15	Loop-1 Auto-Tuning Parameter Value #2
4	0-15	Loop-1 Auto-Tuning Parameter Value #3
5	0-15	Loop-1 Auto-Tuning Parameter Value #4
6	0-15	Loop-1 Auto-Tuning Parameter Value #5
7	0-15	Loop-1 Auto-Tuning Parameter Value #6
8	0-15	Loop-1 Auto-Tuning Parameter Value #7
9	0-15	Loop-2 Auto-Tuning Parameter Value #1
10	0-15	Loop-2 Auto-Tuning Parameter Value #2
11	0-15	Loop-2 Auto-Tuning Parameter Value #3
12	0-15	Loop-2 Auto-Tuning Parameter Value #4
13	0-15	Loop-2 Auto-Tuning Parameter Value #5
14	0-15	Loop-2 Auto-Tuning Parameter Value #6
15	0-15	Loop-2 Auto-Tuning Parameter Value #7
16	0-15	Loop-3 Auto-Tuning Parameter Value #1
17	0-15	Loop-3 Auto-Tuning Parameter Value #2
18	0-15	Loop-3 Auto-Tuning Parameter Value #3
19	0-15	Loop-3 Auto-Tuning Parameter Value #4
20	0-15	Loop-3 Auto-Tuning Parameter Value #5
21	0-15	Loop-3 Auto-Tuning Parameter Value #6
22	0-15	Loop-3 Auto-Tuning Parameter Value #7

Word	Bits	Description
23	0-15	Loop-4 Auto-Tuning Parameter Value #1
24	0-15	Loop-4 Auto-Tuning Parameter Value #2
25	0-15	Loop-4 Auto-Tuning Parameter Value #3
26	0-15	Loop-4 Auto-Tuning Parameter Value #4
27	0-15	Loop-4 Auto-Tuning Parameter Value #5
28	0-15	Loop-4 Auto-Tuning Parameter Value #6
29	0-15	Loop-4 Auto-Tuning Parameter Value #7
30	0-15	Loop-5 Auto-Tuning Parameter Value #1
31	0-15	Loop-5 Auto-Tuning Parameter Value #2
32	0-15	Loop-5 Auto-Tuning Parameter Value #3
33	0-15	Loop-5 Auto-Tuning Parameter Value #4
34	0-15	Loop-5 Auto-Tuning Parameter Value #5
35	0-15	Loop-5 Auto-Tuning Parameter Value #6
36	0-15	Loop-5 Auto-Tuning Parameter Value #7
37	0-15	Loop-6 Auto-Tuning Parameter Value #1
38	0-15	Loop-6 Auto-Tuning Parameter Value #2
39	0-15	Loop-6 Auto-Tuning Parameter Value #3
40	0-15	Loop-6 Auto-Tuning Parameter Value #4
41	0-15	Loop-6 Auto-Tuning Parameter Value #5
42	0-15	Loop-6 Auto-Tuning Parameter Value #6
43	0-15	Loop-6 Auto-Tuning Parameter Value #7
44	0-15	Loop-7 Auto-Tuning Parameter Value #1
45	0-15	Loop-7 Auto-Tuning Parameter Value #2
46	0-15	Loop-7 Auto-Tuning Parameter Value #3
47	0-15	Loop-7 Auto-Tuning Parameter Value #4
48	0-15	Loop-7 Auto-Tuning Parameter Value #5
49	0-15	Loop-7 Auto-Tuning Parameter Value #6
50	0-15	Loop-7 Auto-Tuning Parameter Value #7

Appendix D

Saving Auto-Tuning Parameter Values

Word	Bits	Description
51	0-15	Loop-8 Auto-Tuning Parameter Value #1
52	0-15	Loop-8 Auto-Tuning Parameter Value #2
53	0-15	Loop-8 Auto-Tuning Parameter Value #3
54	0-15	Loop-8 Auto-Tuning Parameter Value #4
55	0-15	Loop-8 Auto-Tuning Parameter Value #5
56	0-15	Loop-8 Auto-Tuning Parameter Value #6
57	0-15	Loop-8 Auto-Tuning Parameter Value #7

A

A/D resolution, [A-1](#)
alarm
 dead band, [4-2](#)
 hysteresis, [4-2](#)
audience, [i](#)
auto-tuning, [3-2](#), [5-1](#)
auto-tuning status/command block, [D-2](#)

B

backplane current load, [2-2](#)
block ID
 configuration block, [4-1](#)
 dynamic block, [6-1](#)
 gains block, [5-2](#)
 status block, [7-1](#)
block-transfer, [1-3](#), [3-8](#)
block-transfer write, [3-9](#)
block-transfer read, [3-10](#)
block-transfer sequece, [7-1](#), [D-1](#)
block-transfer sequece, [5-1](#), [6-1](#)

C

cables, [2-5](#)
calibrating, [8-1](#)
calibration
 block-transfer read, [8-3](#)
 block-transfer write, [8-2](#)
 period, [8-1](#)
 preperation, [8-1](#)
 procedure, [8-5](#)
 read block, [8-3](#)
 tools, [8-1](#)
 write block, [8-2](#)
communication, how data is transferred, [1-3](#)
communication sequence, [3-2](#)
compatibility
 I/O chassis, [ii](#)
 processor, [ii](#)
 remote termination panel, [ii](#)
 use of data table, [i](#)
configuration block, [4-3](#)
configuring the module, [4-1](#)

connecting wiring, [2-7](#)
control bits, [3-3](#)
cooling elements, [3-6](#)

D

data table use, [i](#)
dead band, [4-2](#)
diagnostic indicators, [2-10](#), [8-1](#), [9-1](#)
diagnostics, indicators, [9-1](#)
dynamic block, [6-2](#)

E

electrostatic damage, [2-1](#)
enclosure depth, [2-2](#)
error codes, [7-3](#), [7-5](#), [7-7](#), [7-9](#), [7-11](#),
[7-13](#), [7-15](#), [7-17](#), [B-1](#)

F

features, [1-2](#)
fine-tuning, [5-2](#)

G

gains block, [5-3](#)
grounding, [2-9](#)
grounding shields, [2-9](#)

H

heating elements, [3-4](#), [3-6](#)
hysteresis, [4-2](#)

I

I/O image, [i](#), [3-1](#)
implied decimal point, dynamic block, [7-1](#)
indicators, [2-10](#), [8-1](#), [9-1](#)
 CAL/COM, [9-1](#)
 operation during calibration, [8-1](#)
 RUN/FLT, [9-1](#)
inferred decimal point
 configuration block, [4-2](#)

dynamic block, [6-1](#)
gains block, [5-2](#)
installation, of module, [2-4](#)

K

keying, [2-3](#)

L

location for the module, [2-2](#)

M

manual organization, [_iii](#)
module configuration, [4-1](#)
module installation, [2-4](#)
module location, [2-2](#)
module update period, [3-11](#)
monitoring status data, [7-1](#)

O

operating the module, [6-1](#)
out-of-range value, [7-3](#), [7-5](#), [7-7](#), [7-9](#),
[7-11](#), [7-13](#), [7-15](#), [7-17](#)
out-of-range values, [B-1](#)

P

PID loops, [1-1](#), [1-3](#)
power requirements, [2-2](#)
pre-installation considerations, [2-1](#)
programming
 block-transfer, [3-8](#)
 single-transfer, [3-3](#)

R

reference values, calibration, [8-5](#)

related publications, [_ii](#)
remote termination panel, [2-2](#), [2-4](#)
 connections, [2-6](#)
resolution, [A-1](#)

S

saving auto-tuning parameter values, [D-1](#)
sequence of block-transfers, [7-1](#), [D-1](#)
sequence of block-transfers, [5-1](#), [6-1](#)
sequence of communication, [3-2](#)
setting gains, [5-1](#), [7-1](#)
single-transfer, [1-3](#), [3-3](#)
specifications, [A-1](#)
status block, [7-2](#)
system status block, [7-2](#)

T

TC break detection, [4-1](#)
temperature specifications, [A-2](#)
thermal runaway detection, [4-1](#)
thermocouple connection, [2-7](#)
TPO, [_ii](#), [1-2](#), [3-1](#), [3-2](#), [3-3](#)
TPO bits, [3-4](#)
troubleshooting, [9-1](#)
 indicators, [9-2](#)
 status reported by the module, [9-2](#)
 with indicators, [9-2](#)

U

update period, [3-11](#)

V

vocabulary, [_ii](#)



ALLEN-BRADLEY
A ROCKWELL INTERNATIONAL COMPANY

Allen-Bradley has been helping its customers improve productivity and quality for 90 years. A-B designs, manufactures and supports a broad range of control and automation products worldwide. They include logic processors, power and motion control devices, man-machine interfaces and sensors. Allen-Bradley is a subsidiary of Rockwell International, one of the world's leading technology companies.



With major offices worldwide.

Algeria • Argentina • Australia • Austria • Bahrain • Belgium • Brazil • Bulgaria • Canada • Chile • China, PRC • Colombia • Costa Rica • Croatia • Cyprus • Czech Republic • Denmark • Ecuador • Egypt • El Salvador • Finland • France • Germany • Greece • Guatemala • Honduras • Hong Kong • Hungary • Iceland • India • Indonesia • Israel • Italy • Jamaica • Japan • Jordan • Korea • Kuwait • Lebanon • Malaysia • Mexico • New Zealand • Norway • Oman • Pakistan • Peru • Philippines • Poland • Portugal • Puerto Rico • Qatar • Romania • Russia-CIS • Saudi Arabia • Singapore • Slovakia • Slovenia • South Africa, Republic • Spain • Switzerland • Taiwan • Thailand • The Netherlands • Turkey • United Arab Emirates • United Kingdom • United States • Uruguay • Venezuela • Yugoslavia

World Headquarters, Allen-Bradley, 1201 South Second Street, Milwaukee, WI 53204 USA, Tel: (1) 414 382-2000 Fax: (1) 414 382-4444