



Allen-Bradley

***Enhanced
PLC-5
Programmable
Controller***

***(Cat. No. 1785-L11B,
-L20B, -L30B, -L40B,
-L40L, -L60B, -L60L,
-L80B)***

Quick Start

Allen-Bradley Replacements

Important User Information

Because of the variety of uses for the products described in this publication, those responsible for the application and use of this control equipment must satisfy themselves that all necessary steps have been taken to assure that each application and use meets all performance and safety requirements, including any applicable laws, regulations, codes and standards.

The illustrations, charts, sample programs and layout examples shown in this guide are intended solely for purposes of example. Since there are many variables and requirements associated with any particular installation, Allen-Bradley does not assume responsibility or liability (to include intellectual property liability) for actual use based upon the examples shown in this publication.

Allen-Bradley publication SGI-1.1, *Safety Guidelines for the Application, Installation, and Maintenance of Solid-State Control* (available from your local Allen-Bradley office), describes some important differences between solid-state equipment and electromechanical devices that should be taken into consideration when applying products such as those described in this publication.

Reproduction of the contents of this copyrighted publication, in whole or in part, without written permission of Allen-Bradley Company, Inc., is prohibited.

Throughout this manual we use notes to make you aware of safety considerations:



ATTENTION: Identifies information about practices or circumstances that can lead to personal injury or death, property damage or economic loss.

Attention statements help you to:

- identify a hazard
- avoid the hazard
- recognize the consequences

Important: Identifies information that is critical for successful application and understanding of the product.

Preface

Read this preface to familiarize yourself with the rest of the manual.

This preface covers the following topics:

- who should use this manual
- the purpose of this manual
- how to use this manual
- conventions used in this manual
- Rockwell Automation support

Who Should Use This Manual

To use this manual, you should understand programmable controllers and be able to interpret the ladder logic instructions required to control your application. For more information, see the documents listed on the following page or contact your local Rockwell Automation representative.

Purpose of This Manual

This manual is for users of the Enhanced PLC-5® processor. It:

- presents you with the basic information you need to get your system up and running
- provides “memory jogger” information, such as specific bit and switch settings for modules
- includes high-level procedures with cross-references to other manuals for more detail

How to Obtain a User Manual

There is a user manual associated with this product that contains detailed information about configuring, programming, and using a PLC-5 processor. To obtain a copy of the Enhanced and Ethernet PLC-5 Programmable Controllers User Manual, publication number 1785-6.5.12, you can either:

- view or download an electronic version from the internet:
www.theautomationbookstore.com
- purchase a hardcopy from the internet:
www.theautomationbookstore.com
- contact your local distributor or Rockwell Automation representative to place an order.

See the table on the next page for other related publications.

Related Documentation

The following documents contain additional information concerning the products discussed in this manual.

For more information about:	See this document:	Publication number:
Enhanced PLC-5 programmable controllers	Enhanced and Ethernet PLC-5 Programmable Controllers User Manual	1785-6.5.12
Universal 1771 I/O chassis	Universal I/O Chassis Installation Instructions	1771-2.210
power supply	Power Supply Modules (1771-P4S, -P6S, -P4S1, -P6S1) Installation Instructions	1771-2.135
DH+® network	Enhanced and Ethernet PLC-5 Programmable Controllers User Manual	1785-6.5.12
	Data Highway/Data Highway Plus/Data Highway II/Data Highway-485 Cable Installation Instructions	1770-6.2.2
communication cards	1784-KTx Communication Interface Card User Manual	1784-6.5.22
	Allen-Bradley Publication Index (for your specific communication card)	SD499
cables	Enhanced and Ethernet PLC-5 Programmable Controllers User Manual	1785-6.5.12
batteries	Allen-Bradley Guidelines for Lithium Battery Handling and Disposal	AG-5.4
grounding and wiring Allen-Bradley programmable controllers	Allen-Bradley Programmable Controller Wiring and Grounding Guidelines	1770-4.1
current Allen-Bradley documentation, including ordering instructions	Allen-Bradley Publication Index	SD499
terms and definitions	Allen-Bradley Industrial Automation Glossary	AG-7.1

Common Techniques Used in This Manual

We use the following conventions throughout this manual:

- Bulleted lists provide information, not procedural steps.
- Numbered lists provide sequential steps or hierarchical information.



We use this symbol to indicate additional references you can use when you need more information about a particular topic.

Rockwell Automation Support

Rockwell Automation offers support services worldwide, with over 75 sales/support offices, 512 authorized distributors, and 260 authorized systems integrators located throughout the United States alone, plus Rockwell Automation representatives in every major country in the world.

Local Product Support

Contact your local Rockwell Automation representative for:

- sales and order support
- product technical training
- warranty support
- support service agreements

Technical Product Assistance

If you need to contact Rockwell Automation for technical assistance, call your local Rockwell Automation representative.

Your Questions or Comments about This Manual

If you discover a problem with this manual, please notify us of it by completing and sending the enclosed Publication Problem Report (at the back of this manual).

If you have any suggestions about how we can make this manual more useful to you, please contact us at the address below:

Allen-Bradley Company, Inc.
Automation Group
Technical Communication
1 Allen-Bradley Drive
Mayfield Heights, OH 44124-6118

Telephone: (440) 646-5000

FAX: (440) 646-4320

Allen-Bradley Replacements

Overview	Chapter 1
	What You Need to Do 1-1
	Identifying the Processor's Front Panel Components 1-2
	Components You Need 1-4
	Compliance to European Union Directives 1-4
	EMC Directive 1-4
	Low Voltage Directive 1-4
Set up the Hardware	Chapter 2
	Install the Hardware 2-2
	Configure the I/O Chassis 2-2
	Ground the I/O Chassis 2-4
	Install the Power Supply 2-4
	Install the PLC-5 Processor 2-5
	Power Up the System 2-6
	Install the I/O Modules 2-6
	Connect the Personal Computer to the PLC-5 Processor 2-6
Set up the Software	Chapter 3
	Install the Software and Set Up the Programming System 3-1
	Start the Programming Software 3-1
	Power Up the System 3-2
Troubleshoot the Processor System	Chapter 4
	Use the PLC-5 Processor Status Indicators 4-1
	Troubleshoot General Problems 4-1
	Troubleshoot the Processor Communication Channels 4-2
Specifications	Appendix A
	General A-1
	Battery Specification A-2
	Battery Type A-2
	Average Battery Lifetime Specifications A-2
	Processor Specifications A-3

Overview

This quick start is designed to provide you with the information you need to get your system up and running quickly. Use this document if you are knowledgeable about Enhanced PLC-5 products, but may not have used one or more of them recently. The information we provide is geared to “jog your memory”.

What You Need to Do

If you need more information, see the Enhanced and Ethernet PLC-5 Programmable Controllers User Manual, publication number 1785-6.5.12 (see page P-1 for information about how to obtain a copy of this manual).

*Set up the Hardware
(Chapter 2)*

*Set up the Software
(Chapter 3)*

*Troubleshoot the
Processor System
(Chapter 4)*

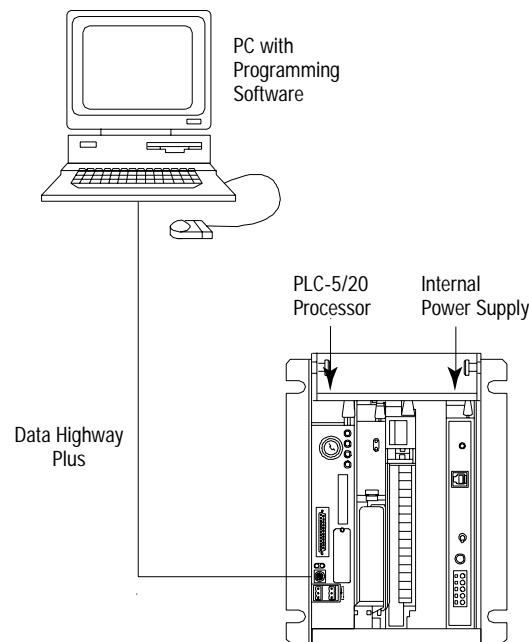

Identifying the Processor's Front Panel Components

These pictures show the Enhanced PLC-5 processor front panel components.

PLC-5/11, -5/20, and -5/26 Processor Front Panel

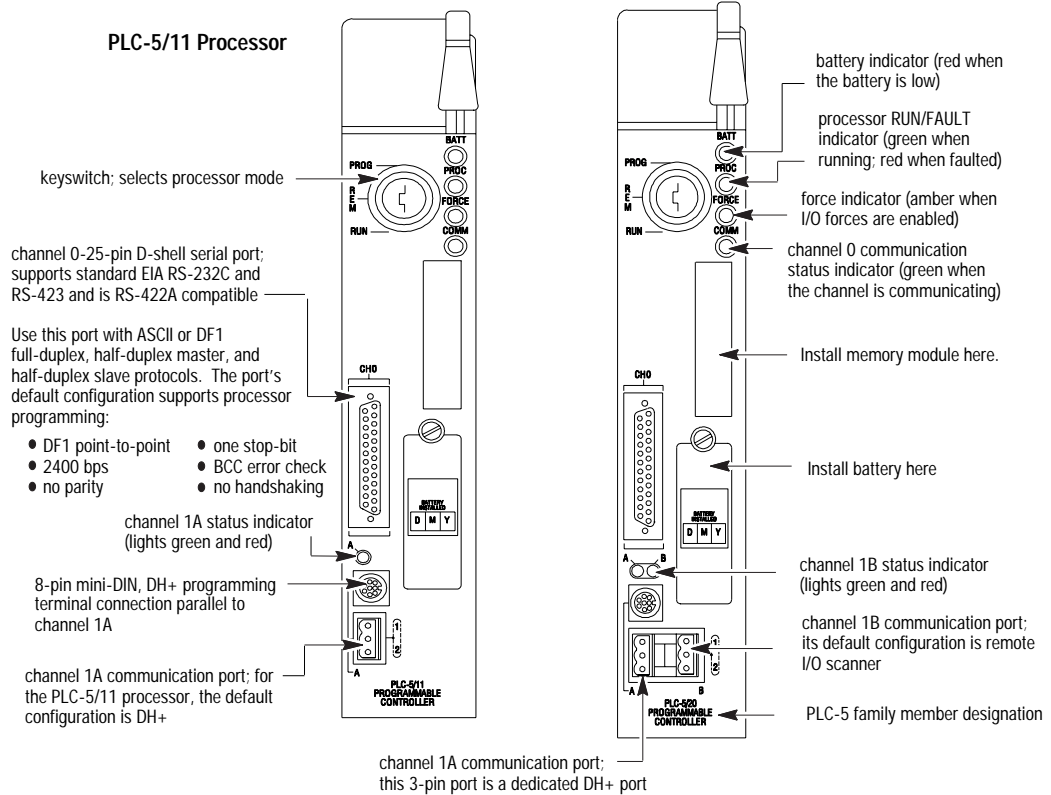

PLC-5/30 Processor Front Panel

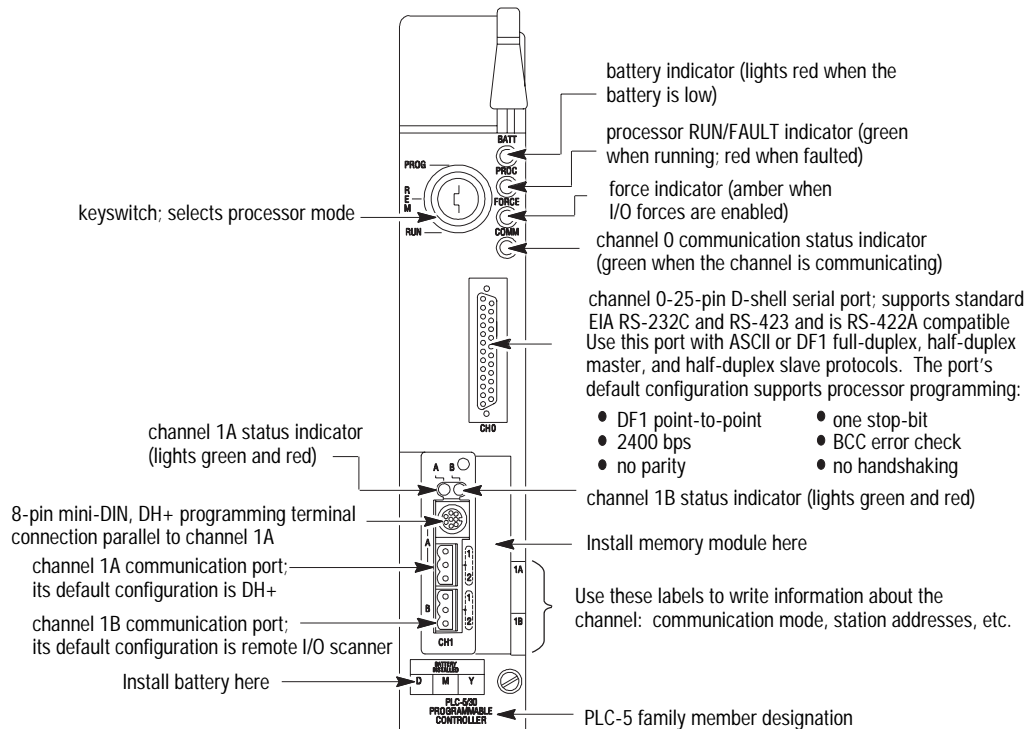

PLC-5/40, -5/46, -5/60, -5/80, and -5/86 Processor Front Panels

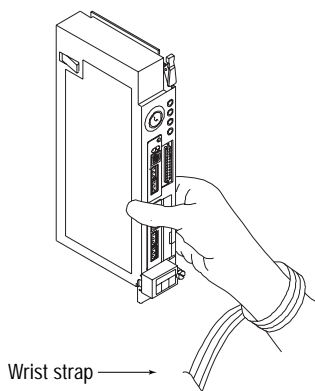
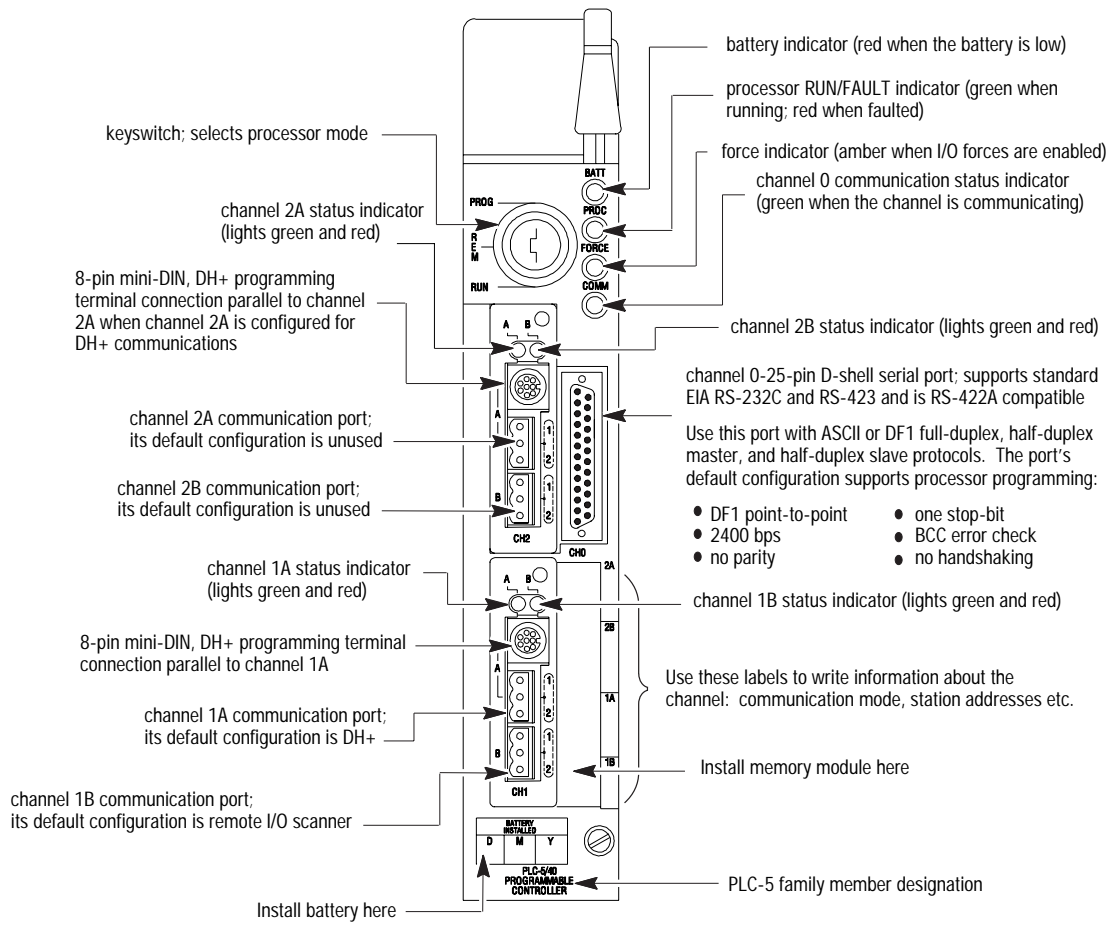

ATTENTION: Make sure you understand the anti-static environment.

The processor is shipped in a static-shielded container to guard against electrostatic damage. Electrostatic discharge can damage integrated circuits or semiconductors in the processor module if you touch backplane connector pins. It can also damage the module when you set configuration plugs or switches inside the module. Avoid electrostatic damage by observing the following precautions.

- Remain in contact with an approved ground point while handling the module (by wearing a properly grounded wrist strap).
- Do not touch the backplane connector or connector pins.
- When not in use, keep the module in its static-shielded container.

Components You Need

Product name:	Catalog number:
Hardware	
Enhanced PLC-5 processor with 2 keys	1785-L11B, -L20B, -L30B, -L40B, -L40L, -L60B, -L60L, -L80B
Lithium Battery (in a clear bag)	1770-XYC
I/O chassis	1771-A1B, -A2B, -A3B, -A3B1, -A4B
Power supply	1771-P4S, -P6S, -P4S1, -P6S1
Programming System	
PC	Check your programming software documentation for system requirements, such as memory, etc.
PLC-5 programming software	Choose a programming software package that is compatible with Enhanced PLC-5 processors.
communication module	DH+ interface and interconnect cable

Important: In this manual, we assume you are using a brand-new Enhanced PLC-5 processor out of the box.

Compliance to European Union Directives

If this product has the CE mark it is approved for installation within the European Union and EEA regions. It has been designed and tested to meet the following directives.

EMC Directive

This product is tested to meet Council Directive 89/336/EEC Electromagnetic Compatibility (EMC) and the following standards, in whole or in part, documented in a technical construction file:

- EN 50081-2EMC – Generic Emission Standard, Part 2 – Industrial Environment
- EN 50082-2EMC – Generic Immunity Standard, Part 2 – Industrial Environment

This product is intended for use in an industrial environment.

Low Voltage Directive

This product is tested to meet Council Directive 73/23/EEC Low Voltage, by applying the safety requirements of EN 61131-2 Programmable Controllers, Part 2 – Equipment Requirements and Tests.

For specific information required by EN 61131-2, see the appropriate sections in this publication, as well as the following Allen-Bradley publications:

- Industrial Automation Wiring and Grounding Guidelines For Noise Immunity, publication 1770-4.1
- Guidelines for Handling Lithium Batteries, publication AG-5.4
- Automation Systems Catalog

Set up the Hardware

- 1 *Install the hardware
(page 2-2)*
- 2 *Connect the personal computer
to the PLC-5 processor
(page 2-6)*

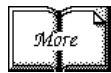
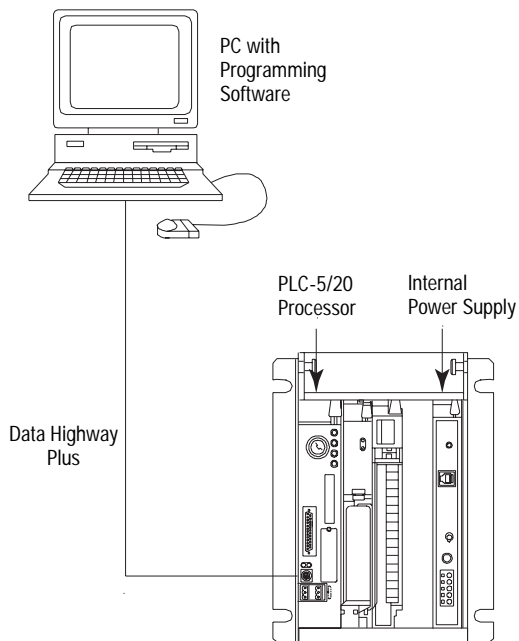

For more information, see the Enhanced and Ethernet User Manual, publication number 1785-6.5.12.

Install the Hardware

Configure the I/O Chassis

1 Set the backplane switches.

- Pressed in at top ON (closed)
- Pressed in at bottom OFF (open)

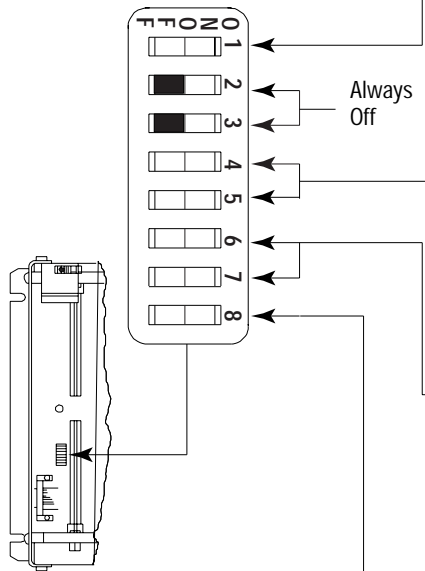

Switch	Last State
1	
on	Outputs of this I/O chassis remain in their last state when a hardware failure occurs. ¹
off	Outputs of this I/O chassis are turned off when a hardware failure occurs. ¹

Switches		Addressing
4	5	
off	off	2 - slot
off	on	1 - slot
on	off	1/2 - slot
on	on	Not allowed

Switches		EEPROM Transfer
6	7	
off	off	EEPROM memory transfer to processor memory at power-up. ^{2, 3}
on	on	EEPROM memory transfers to processor memory if processor memory not valid.
on	off	EEPROM memory does not transfer to processor memory. ⁴

Switch	Processor Memory Protection
8	
off	Processor memory protection disabled.
on	Processor memory protection enabled. ⁵

- 1 Regardless of this switch setting, outputs are turned off when any of the following occurs:
 - processor detects a runtime error
 - an I/O chassis backplane fault occurs
 - you select program or test mode
 - you set a status file bit to reset a local rack
- 2 If an EEPROM module is not installed and processor memory is valid, the processor's PROC LED indicator blinks, and the processor sets S:11/9, bit 9 in the major fault status word. To clear this fault, change the processor from program mode to run mode and back to program mode.
- 3 If the processor's keyswitch is set in REMote, the processor enters remote RUN after it powers up and has its memory updated by the EEPROM module.
- 4 A processor fault (solid red PROC LED) occurs if processor memory is not valid.
- 5 You cannot clear processor memory when this switch is on.

2 Set the power supply configuration jumper.

3 Install the keying bands.

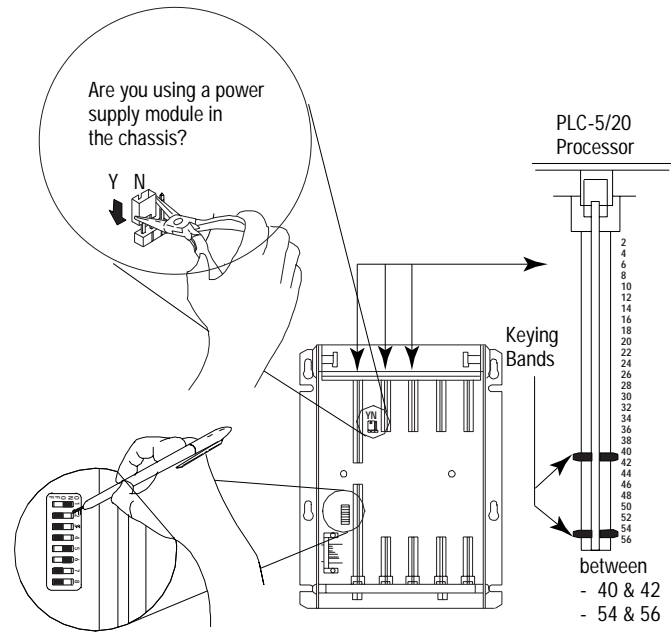

20609-M



Configuring an I/O rack for a local PLC-5 is different than configuring a remote I/O rack using a 1771-ASB module. For more information about configuring a remote I/O rack using a 1771-ASB module, see the following:

- Remote I/O Adapter Module User Manual, publication number, 1771-6.5.83
- Enhanced and Ethernet PLC-5 Programmable Controllers User Manual, publication number 1785-6.5.12



For more information, see the Universal I/O Chassis installation instructions, publication number 1771-2.10.

Ground the I/O Chassis

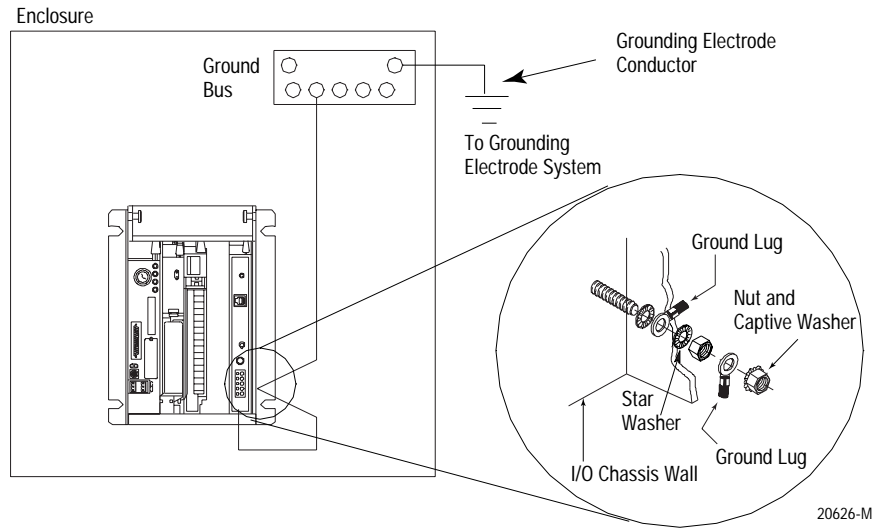

20626-M

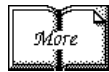

For more information, see the Allen-Bradley Programmable Controller Wiring and Grounding Guidelines, publication number 1770-4.1.

Install the Power Supply

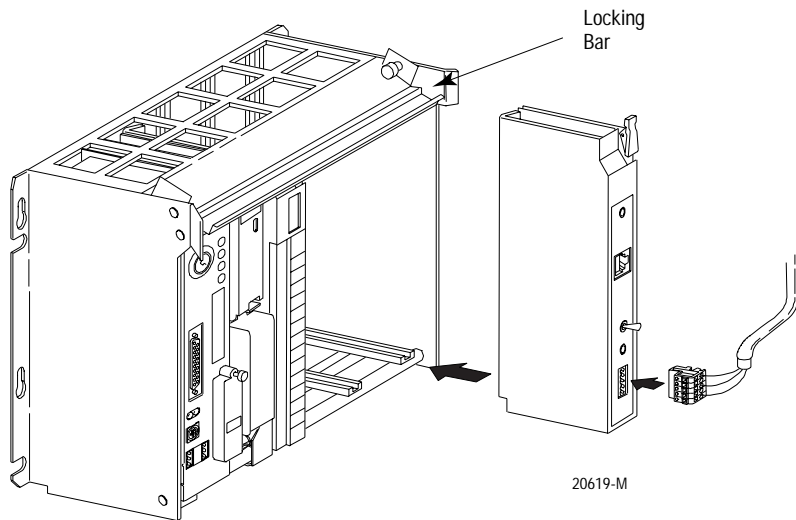

20619-M

1 Set the jumpers on the back side of the power supply like this:

2 Connect the power cord to the 120V ac connector of the power supply module.

This side plugs into connector on the module.

3 Install the power supply in the chassis and snap the module-locking bar over the modules



For more information, see the Power Supply Modules (1771-P4S, -P6S, -P4S1, -P6S1) Installation Instructions, publication number 1771-2.135 or the AC (120/220V) 16A Power Supply (1771-P7 Series B/C) Installation Instructions, publication number 1771-5.39.

Install the PLC-5 Processor

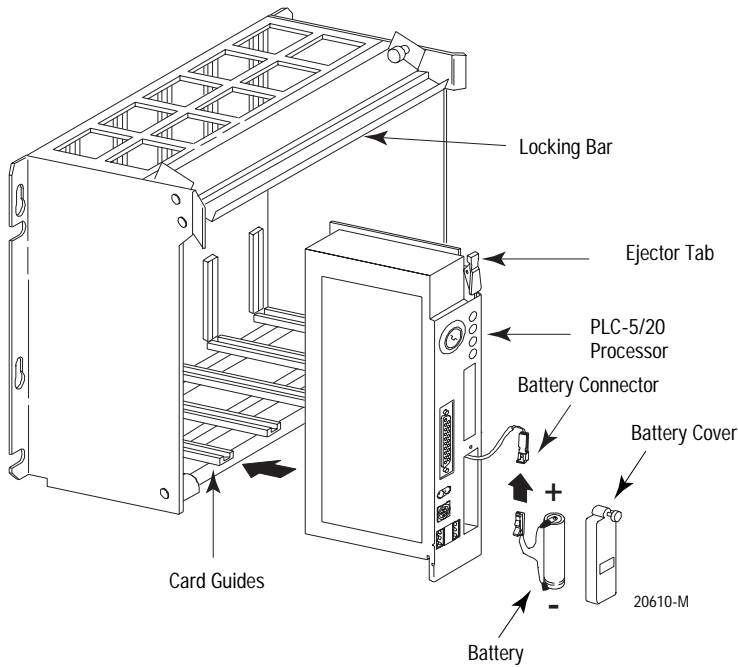

For detailed information about handling and disposing of the battery as well as other important guidelines, see publication AG-5.4.



For more information, see the Enhanced and Ethernet PLC-5 Programmable Controllers User Manual, publication number 1785-6.5.12.

1 Define the DH+ Station Address of Channel 1A by setting switch assembly SW-1 on the back of the processor. (See the side of the processor if you want to use another address.)

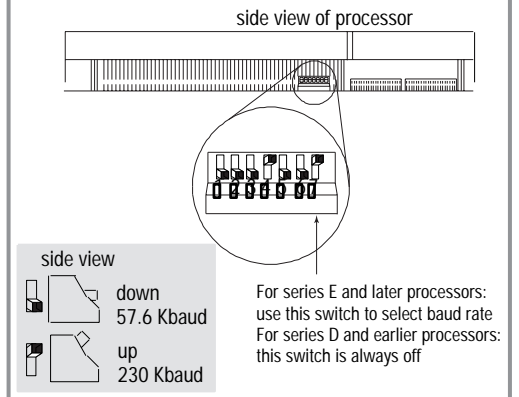

2 Specify the digital interface of channel 0.

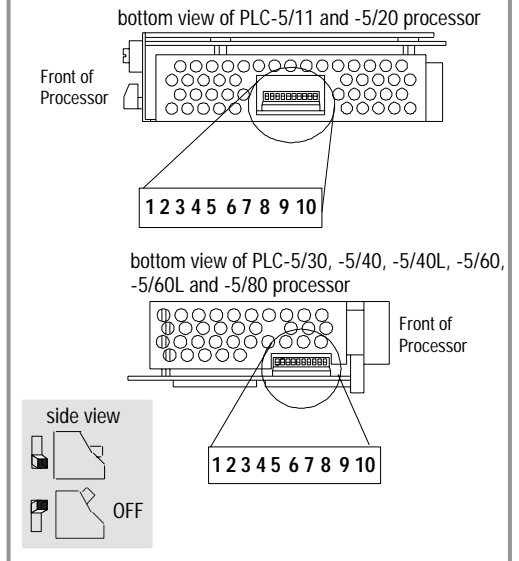

3 To install the battery, slide the battery-side connector into the processor-side connector until you hear them snap together, and attach the battery cover.

4 Install the processor module.

Power Up the System

Power up the system. Check the LED display on the processor. If your system is operating properly, the PROC LED should be steady red. If the PROC LED is not red, see chapter 4 for troubleshooting information before you install any I/O modules.

Install the I/O Modules

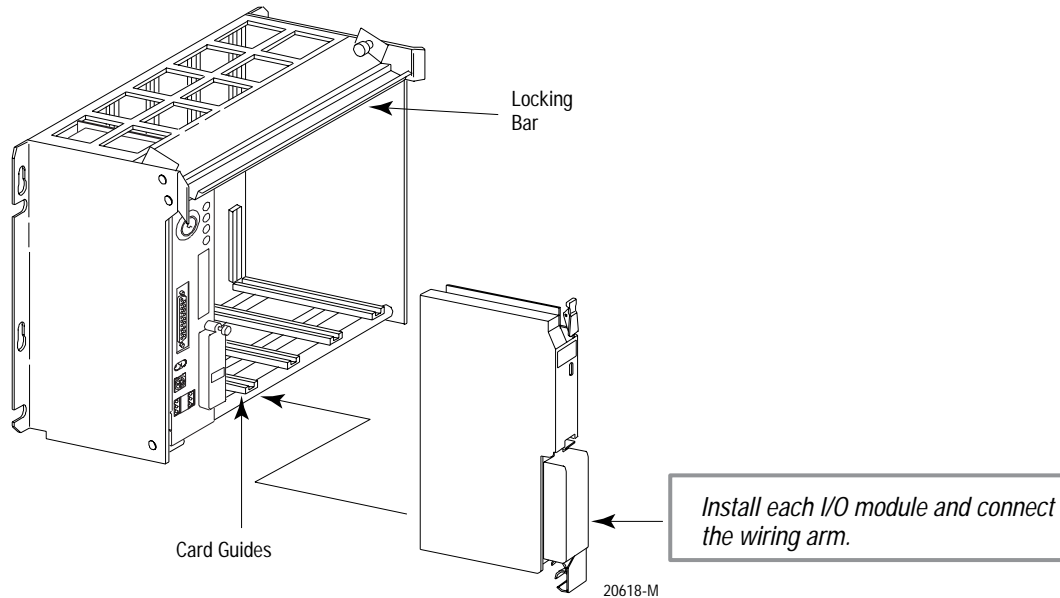

For more information, see the installation instructions or user manual for the particular module you are installing.

Connect the Personal Computer to the PLC-5 Processor



For more information, see:

- Enhanced and Ethernet PLC-5 Programmable Controllers User Manual, publication number 1785-6.5.12
- the documentation provided with your communication card
- Data Highway/Data Highway Plus/Data Highway II/Data Highway 485 Cable Installation Manual, publication 1770-6.2.2

Set up the Software

- 1 *Install the software*
- 2 *Start the programming software*
- 3 *Powerup the system*

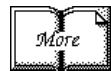
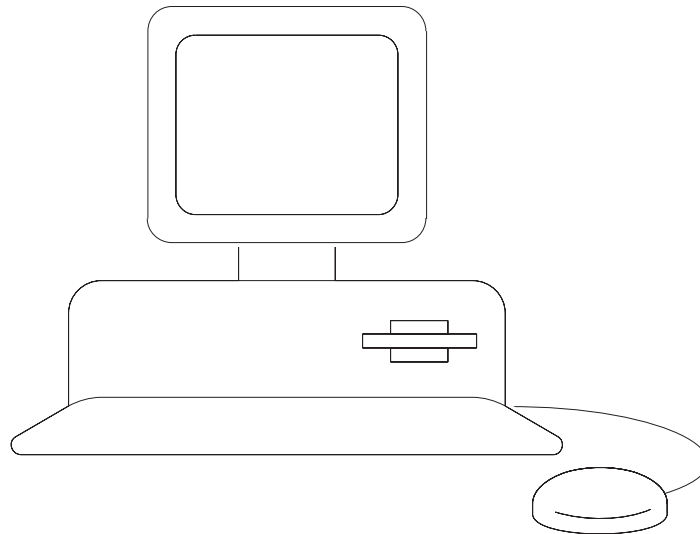

The following instructions are general. For specific information, see the documentation set for your particular software package.

Install the Software and Set Up the Programming System

Before you install your programming software, make certain you meet the system requirements for that software – sufficient disk space, memory, etc. Then, follow the procedures outlined in the software documentation to install the software and configure communication.

Start the Programming Software

Start the programming software by following the procedures described in your programming software documentation.

If you have difficulty, verify that the power supply is turned on.

To monitor your system as you configure and run it, check the processor LED display for the following indicators:

This LED:	lights when:
COMM	you establish DH+ communication
BATT	no battery is installed or the battery voltage is low
REM I/O	you establish Remote I/O communication
ADAPT	the processor is in adapter mode
FORCE	forces are present in your ladder program

Power Up the System

Power up the system if you have not done so already. Check the LED display on the processor. If your system is operating properly, the PROC LED should be steady red and the message "Processor RAM is faulted. Press <Enter> to clear memory" should appear on the display. See the following table to proceed. If the PROC LED is not red, turn to chapter 4 for troubleshooting information.

If your keyswitch is in this position:	do this:
PROGRAM	Clear memory. The PROC LED should turn off. The software is in Program mode.
REMOTE	Clear memory. The PROC LED should turn off. The software is in Remote Program mode.
RUN	You see the message "No access or privilege violation" because you cannot clear memory in Run mode. Change the keyswitch position to Program or Remote and press <Enter> to clear memory.

Troubleshoot the Processor System

1 Use the PLC-5 Processor Status Indicators (page 4-1)

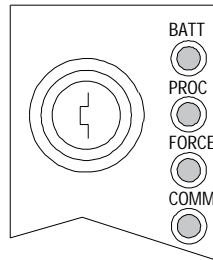

Use the PLC-5 Processor Status Indicators

Troubleshoot General Problems

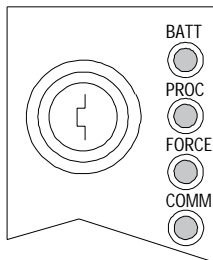

Indicator	Color	Description	Probable Cause	Recommended Action
BATT	Red	Battery low	Battery low	Replace battery within 10 days
	Off	Battery is good	Normal operation	No action required
PROC	Green (steady)	Processor is in run mode and fully operational	Normal operation	No action required
	Green (blinking)	Processor memory is being transferred to EEPROM		
	Red (blinking)	Major fault	Run-time error	<ul style="list-style-type: none"> Check major fault bit in status file (S:11) for error definition Clear fault bit, correct problem, and return to run mode
	Red (steady)	Major fault	<ul style="list-style-type: none"> Processor memory has checksum error Memory module error Internal diagnostics have failed 	<ul style="list-style-type: none"> Clear memory and reload program Check backplane switch settings and/or insert correct memory module Power down, reseal processor and power up; then, clear memory and reload your program. Replace EEPROM with new program; then, if necessary, replace the processor
Off	Processor is in program load or test mode or is not receiving power			Check power supply and connections

Indicator	Color	Description	Probable Cause	Recommended Action
FORCE	Amber (steady)	SFC and/or I/O forces enabled	Normal operation	No action required
	Amber (blinking)	SFC and/or I/O forces present but not enabled		
	Off	SFC and/or I/O forces not present		
COMM	Off	No transmission on channel 0	Normal operation if channel is not being used	
	Green (blinking)	Transmission on channel 0	Normal operation if channel is being used	

Troubleshoot the Processor Communication Channels

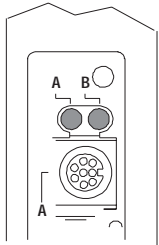
Indicator	Color	Channel Mode	Description	Probable Cause	Recommended Action
A or B	Green (steady)	Remote I/O Scanner	Active Remote I/O link, all adapter modules are present and not faulted	Normal operation	No action required
		Remote I/O Adapter	Communicating with scanner		
	Green (blinking rapidly or slowly)	Remote I/O Scanner	At least one adapter is faulted or has failed	<ul style="list-style-type: none"> Power off at remote rack Cable broken 	<ul style="list-style-type: none"> Restore power to the rack Repair cable
		DH+	No other nodes on network		
	Red (steady)	Remote I/O Scanner Remote I/O Adapter DH+	Hardware fault	Hardware error	<ul style="list-style-type: none"> Turn power off, then on. Check that the software configurations match the hardware set-up. Replace the processor.
	Red (blinking rapidly or slowly)	Remote I/O Scanner	Faulted adapters detected	<ul style="list-style-type: none"> Cable not connected or is broken Power off at remote racks 	<ul style="list-style-type: none"> Repair cable Restore power to racks
		DH+	Bad communication on DH+	Duplicate node detected	Correct station address
	Off	Remote I/O Scanner Remote I/O Adapter DH+	Channel offline	Channel is not being used	Place channel online if needed

Specifications

General

This table lists general specifications.

Backplane Current	PLC-5/11, -5/20, -5/30 2.3 A PLC-5/40, -5/40L, -5/60, -5/60L -5/80 3.3 A
Heat Dissipation	PLC-5/11, -5/20, -5/30 41.30 BTU/hr PLC-5/40, -5/40L, -5/60, -5/60L -5/80 59.04 BTU/hr
Environmental Conditions	Operating Temperature..... 0 to 60° C (32-140° F) Storage Temperature -40 to 85° C (-40 to 185° F) Relative Humidity 5 to 95% (without condensation)
Shock	Operating 30 g peak acceleration for 11±1 ms duration Non-operating ... 50 g peak acceleration for 11±1 ms duration
Vibration (operating and non-operating)	1 g @ 10 to 500 Hz 0.012 inches peak-to-peak displacement
Time-of-Day Clock/Calendar¹	Maximum Variations at 60° C. . ± 5 min per month Typical Variations at 20° C. . . ± 20 s per month Timing Accuracy..... 1 program scan
Battery	1770-XYC
Memory Modules	1785-ME16 1785-ME64 1785-ME32 1785-M100
Typical Discrete I/O Scan	<ul style="list-style-type: none"> • 0.5 ms / extended-local I/O adapter • 10 ms / remote I/O rack at 57.6 kbps • 7 ms / remote I/O rack at 115.2 kbps • 3 ms / remote I/O rack at 230.4 kbps
I/O Modules	Bulletin 1771 I/O including 8-, 16-, 32-pt, and intelligent modules
Hardware Addressing	2-slot <ul style="list-style-type: none"> • Any mix of 8-pt modules • 16-pt modules must be I/O pairs • No 32-pt modules 1-slot <ul style="list-style-type: none"> • Any mix of 8- or 16-pt modules • 32-pt modules must be I/O pairs 1/2-slot – Any mix of 8-, 16-, or 32-pt modules

¹ Please note that the Clock/Calendar will update appropriately each year, including the year 2000.

General Specifications (continued)

Communication	<ul style="list-style-type: none"> DH+ (trunk line: 3,048 cable-m (10,000 cable-ft); drop line: 30.4 cable-m (100 cable-ft)) DH using 1785-KA Serial remote I/O extended-local I/O (PLC-5/40L and -5/60L processors only) 										
Location	1771-A1B, -A2B, A3B, -A3B1, -A4B, chassis, left-most slot										
Keying	<ul style="list-style-type: none"> Between 40 and 42 Between 54 and 56 										
Weight	<table> <tr> <td>PLC-5/20</td> <td>1.21 kg (2.7 lbs)</td> </tr> <tr> <td>PLC-5/30</td> <td>1.20 kg (2.6 lbs)</td> </tr> <tr> <td>PLC-5/40, -5/40L</td> <td>1.42 kg (3.1 lbs)</td> </tr> <tr> <td>PLC-5/60, -5/60L</td> <td>1.42 kg (3.1 lbs)</td> </tr> <tr> <td>PLC-5/80</td> <td>1.42 kg (3.1 lbs)</td> </tr> </table>	PLC-5/20	1.21 kg (2.7 lbs)	PLC-5/30	1.20 kg (2.6 lbs)	PLC-5/40, -5/40L	1.42 kg (3.1 lbs)	PLC-5/60, -5/60L	1.42 kg (3.1 lbs)	PLC-5/80	1.42 kg (3.1 lbs)
PLC-5/20	1.21 kg (2.7 lbs)										
PLC-5/30	1.20 kg (2.6 lbs)										
PLC-5/40, -5/40L	1.42 kg (3.1 lbs)										
PLC-5/60, -5/60L	1.42 kg (3.1 lbs)										
PLC-5/80	1.42 kg (3.1 lbs)										
Agency Certification (when product is marked)	<ul style="list-style-type: none"> CSA Class I, Division 2, Groups A, B, C, D UL listed CE marked for all applicable directives 										

Battery Specification

Battery Type

Enhanced PLC-5 processors use 1770-XYC batteries which contain 0.65 grams of lithium.

Average Battery Lifetime Specifications

Battery used in this processor:	At this temperature:	Worst-case Battery Life Estimates		Battery Duration after the LED lights ¹
		Power off 100%:	Power off 50%:	
PLC-5/11, -5/20	60°C	256 days	1.4 years	11.5 days
	25°C	2 years	4 years	47 days
PLC-5/30, -5/40, -5/40L, -5/60, -5/60L, -5/80	60°C	84 days	150 days	5 days
	25°C	1 year	1.2 years	30 days

¹ The battery indicator (BATT) warns you when the battery is low. These durations are based on the battery supplying the only power to the processor (power to the chassis is off) once the LED first lights.

Processor Specifications







This table lists specifications of each Enhanced PLC-5 family processor.

Processor/ Cat. No.	Maximum User Memory Words	Maximum I/O	Types of Communication Ports	Maximum Number of I/O Racks	Maximum Number of I/O Chassis		
					Total	Ext Local	Remote
PLC-5/11 (1785-L11B)	8 K	<ul style="list-style-type: none"> • 512 (any mix or analog) or • 384 in + 384 out (complementary) 	<ul style="list-style-type: none"> • 1 DH+/Remote I/O (Adapter or Scanner) • 1 serial port, configurable for RS-232 and 423 and RS-422A compatible 	4 (0-3)	5	0	4 (must be rack 3)
PLC-5/20 (1785-L20B) PLC-5/26 (1785-L26B)	16K	<ul style="list-style-type: none"> • 512 (any mix or analog) or • 512 in + 512 out (complementary) 	<ul style="list-style-type: none"> • 1 DH+ (Fixed) • 1 DH+/Remote I/O (Adapter or Scanner) • 1 serial port, configurable for RS-232 and 423 and RS-422A compatible 	4 (0-3)	13	0	12
PLC-5/30 (1785-L30B)	32 K	<ul style="list-style-type: none"> • 1024 (any mix or analog) or • 1024 in + 1024 out (complementary) 	<ul style="list-style-type: none"> • 2 DH+/Remote I/O (Adapter or Scanner) • 1 serial port, configurable for RS-232 and 423 and RS-422A compatible 	8 (0-7)	29	0	28
PLC-5/40 (1785-L40B)	48 K ¹	<ul style="list-style-type: none"> • 2048 (any mix or analog) or • 2048 in + 2048 out (complementary) 	<ul style="list-style-type: none"> • 4 DH+/Remote I/O (Adapter or Scanner) • 1 serial port, configurable for RS-232 and 423 and RS-422A compatible 	16 (0-17)	61	0	60
PLC-5/40L (1785-L40L)	48 K ¹	<ul style="list-style-type: none"> • 2048 (any mix or analog) or • 2048 in + 2048 out (complementary) 	<ul style="list-style-type: none"> • 2 DH+/Remote I/O (Adapter or Scanner) • 1 serial port, configurable for RS-232 and 423 and RS-422A compatible • 1 Extended-local I/O 	16 (0-17)	61	16	60
PLC-5/60 (1785-L60B)	64 K ²	<ul style="list-style-type: none"> • 3072 (any mix or analog) or • 3072 in + 3072 out (complementary) 	<ul style="list-style-type: none"> • 4 DH+/Remote I/O (Adapter or Scanner) • 1 serial port, configurable for RS-232 and 423 and RS-422A compatible 	24 (0-27)	93	0	92
PLC-5/60L (1785-L60L)	64 K ²	<ul style="list-style-type: none"> • 3072 (any mix or analog) or • 3072 in + 3072 out (complementary) 	<ul style="list-style-type: none"> • 2 DH+/Remote I/O (Adapter or Scanner) • 1 serial port, configurable for RS-232 and 423 and RS-422A compatible • 1 Extended-local I/O 	24 (0-27)	81	16	64
PLC-5/80 (1785-L80B)	100 ³	<ul style="list-style-type: none"> • 3072 (any mix or analog) or • 3072 in + 3072 out (complementary) 	<ul style="list-style-type: none"> • 4 DH+/Remote I/O (Adapter or Scanner) • 1 serial port, configurable for RS-232 and 423 and RS-422A compatible 	24 (0-27)	93	0	92

¹ The PLC-5/40 and -5/40L processors have a limit of 32K words per data table file.

² The PLC-5/60 and -5/60L processors have a limit of 56K words per program file and 32K words per data table file.

³ The PLC-5/80 processors have 64K words of total data table space with a limit of 56K words per program file and 32K words per data table file.

<p>CSA Hazardous Location Approval</p>	<p>Approbation d'utilisation dans des emplacements dangereux par la CSA</p>
<p>CSA certifies products for general use as well as for use in hazardous locations. Actual CSA certification is indicated by the product label as shown below, and not by statements in any user documentation.</p>	<p>La CSA certifie les produits d'utilisation générale aussi bien que ceux qui s'utilisent dans des emplacements dangereux. La certification CSA en vigueur est indiquée par l'étiquette du produit et non par des affirmations dans la documentation à l'usage des utilisateurs.</p>
<p>Example of the CSA certification product label</p> 	<p>Exemple d'étiquette de certification d'un produit par la CSA</p> 
<p>To comply with CSA certification for use in hazardous locations, the following information becomes a part of the product literature for CSA-certified Allen-Bradley industrial control products.</p> <ul style="list-style-type: none"> • This equipment is suitable for use in Class I, Division 2, Groups A, B, C, D, or non-hazardous locations only. • The products having the appropriate CSA markings (that is, Class I Division 2, Groups A, B, C, D), are certified for use in other equipment where the suitability of combination (that is, application or use) is determined by the CSA or the local inspection office having jurisdiction. 	<p>Pour satisfaire à la certification de la CSA dans des endroits dangereux, les informations suivantes font partie intégrante de la documentation des produits industriels de contrôle Allen-Bradley certifiés par la CSA.</p> <ul style="list-style-type: none"> • Cet équipement convient à l'utilisation dans des emplacements de Classe 1, Division 2, Groupes A, B, C, D, ou ne convient qu'à l'utilisation dans des endroits non dangereux. • Les produits portant le marquage approprié de la CSA (c'est à dire, Classe 1, Division 2, Groupes A, B, C, D) sont certifiés à l'utilisation pour d'autres équipements où la convenance de combinaison (application ou utilisation) est déterminée par la CSA ou le bureau local d'inspection qualifié.
<p>Important: Due to the modular nature of a PLC control system, the product with the highest temperature rating determines the overall temperature code rating of a PLC control system in a Class I, Division 2 location. The temperature code rating is marked on the product label as shown.</p>	<p>Important: Par suite de la nature modulaire du système de contrôle PLC, le produit ayant le taux le plus élevé de température détermine le taux d'ensemble du code de température du système de contrôle d'un PLC dans un emplacement de Classe 1, Division 2. Le taux du code de température est indiqué sur l'étiquette du produit.</p>
<p>Temperature code rating</p> 	<p>Taux du code de température</p> 
<p>The following warnings apply to products having CSA certification for use in hazardous locations.</p>	<p>Les avertissements suivants s'appliquent aux produits ayant la certification CSA pour leur utilisation dans des emplacements dangereux.</p>
 <p>ATTENTION: Explosion hazard –</p> <ul style="list-style-type: none"> • Substitution of components may impair suitability for Class I, Division 2. • Do not replace components unless power has been switched off or the area is known to be non-hazardous. • Do not disconnect equipment unless power has been switched off or the area is known to be non-hazardous. • Do not disconnect connectors unless power has been switched off or the area is known to be non-hazardous. Secure any user-supplied connectors that mate to external circuits on an Allen-Bradley product using screws, sliding latches, threaded connectors, or other means such that any connection can withstand a 15 Newton (3.4 lb.) separating force applied for a minimum of one minute. 	 <p>AVERTISSEMENT: Risque d'explosion –</p> <ul style="list-style-type: none"> • La substitution de composants peut rendre ce matériel inacceptable pour les emplacements de Classe 1, Division 2. • Couper le courant ou s'assurer que l'emplacement est désigné non dangereux avant de remplacer les composants. • Avant de débrancher l'équipement, couper le courant ou s'assurer que l'emplacement est désigné non dangereux. • Avant de débrancher les connecteurs, couper le courant ou s'assurer que l'emplacement est reconnu non dangereux. Attacher tous connecteurs fournis par l'utilisateur et reliés aux circuits externes d'un appareil Allen-Bradley à l'aide de vis, loquets coulissants, connecteurs filetés ou autres moyens permettant aux connexions de résister à une force de séparation de 15 newtons (3,4 lb. - 1,5 kg) appliquée pendant au moins une minute.



Allen-Bradley Publication Problem Report

If you find a problem with our documentation, please complete and return this form

Pub. Name Enhanced PLC-5 Programmable Controller Quick Start
1785-L11B, -L20B, -L30B, -L40B, -
Cat. No. L40L, -L60B, -L60L, -L80B Pub. No. 1785-10.4 Pub. Date November 1998 Part No. 955133-87

Check Problem(s) Type:	Describe Problem(s):	Internal Use Only
<input type="checkbox"/> Technical Accuracy What information is missing?	<input type="checkbox"/> text <input type="checkbox"/> illustration	
<input type="checkbox"/> Completeness What information is missing?	<input type="checkbox"/> procedure/step <input type="checkbox"/> illustration <input type="checkbox"/> definition <input type="checkbox"/> example <input type="checkbox"/> guideline <input type="checkbox"/> feature <input type="checkbox"/> explanation <input type="checkbox"/> other	<input type="checkbox"/> info in manual (accessibility) <input type="checkbox"/> info not in manual
<input type="checkbox"/> Clarity What is unclear?		
<input type="checkbox"/> Sequence What is not in the right order?		
<input type="checkbox"/> Other Comments Use back for more comments.		
Your Name _____	Location/Phone _____	

Return to: Marketing Communications, Allen-Bradley Co., 1 Allen-Bradley Drive, Mayfield Hts., OH 44124-6118 Phone: (440)646-3166 FAX: (440)646-4320

Allen-Bradley Replacements

Other Comments

Multiple horizontal lines for writing comments.

PLEASE FOLD HERE

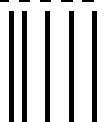

NO POSTAGE
NECESSARY
IF MAILED
IN THE
UNITED STATES

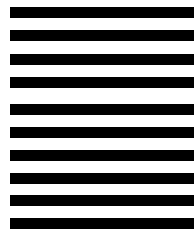

PLEASE REMOVE

BUSINESS REPLY MAIL

FIRST-CLASS MAIL PERMIT NO. 18235 CLEVELAND OH

POSTAGE WILL BE PAID BY THE ADDRESSEE



Allen-Bradley

1 ALLEN BRADLEY DR
MAYFIELD HEIGHTS OH 44124-9705





Rockwell Automation helps its customers receive a superior return on their investment by bringing together leading brands in industrial automation, creating a broad spectrum of easy-to-integrate products. These are supported by local technical resources available worldwide, a global network of system solutions providers, and the advanced technology resources of Rockwell.

Worldwide representation.



Argentina • Australia • Austria • Bahrain • Belgium • Bolivia • Brazil • Bulgaria • Canada • Chile • China, People's Republic of • Colombia • Costa Rica • Croatia • Cyprus • Czech Republic • Denmark • Dominican Republic • Ecuador • Egypt • El Salvador • Finland • France • Germany • Ghana • Greece • Guatemala • Honduras • Hong Kong • Hungary • Iceland • India • Indonesia • Iran • Ireland • Israel • Italy • Jamaica • Japan • Jordan • Korea • Kuwait • Lebanon • Macau • Malaysia • Malta • Mexico • Morocco • The Netherlands • New Zealand • Nigeria • Norway • Oman • Pakistan • Panama • Peru • Philippines • Poland • Portugal • Puerto Rico • Qatar • Romania • Russia • Saudi Arabia • Singapore • Slovakia • Slovenia • South Africa, Republic of • Spain • Sweden • Switzerland • Taiwan • Thailand • Trinidad • Tunisia • Turkey • United Arab Emirates • United Kingdom • United States • Uruguay • Venezuela

Rockwell Automation Headquarters, 1201 South Second Street, Milwaukee, WI 53204 USA, Tel: (1) 414 382-2000, Fax: (1) 414 382-4444

Rockwell Automation European Headquarters SA/NV, avenue Hermann Debrouxlaan, 46, 1160 Brussels, Belgium, Tel: (32) 2 663 06 00, Fax: (32) 2 663 06 40

Rockwell Automation Asia Pacific Headquarters, 27/F Citicorp Centre, 18 Whitfield Road, Causeway Bay, Hong Kong, Tel: (852) 2987 4788, Fax: (852) 2508 1846