



Twisted Pair Transceiver

Catalog Number 1785-TR10BT

The twisted pair transceiver enables a device with an AUI interface to connect to a 10 Mbit/s CSMA/CD LAN (ISO/IEC 8802-3, IEEE 802.3, 10BASE-T) via a shielded twisted pair cable.

- Monitoring LEDs for
 - power
 - collision/jabber control/TxData
 - RxData
 - link state/auto polarity exchange
- SQE test can be disabled externally
- Can be plugged directly to the device interface
- Low current consumption
- Compact construction

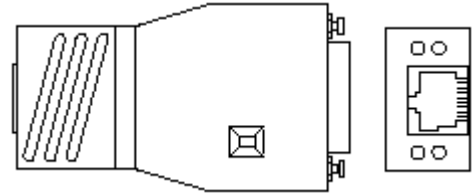

To the Installer

Topic	Page
Description	2
Installation	3
Compliance to European Union Directives	4
Technical Data	7

Description

The 1785-TR10BT twisted pair transceiver can be connected to the AUI interface of a device either directly or via an AUI cable. It is connected to the twisted pair cable by a 8-pin RJ45 socket.

The twisted pair transceiver offers these functions according to IEEE 802.3 10BASE-T:

- indication via a LED of data transmission and reception through the twisted pair cable
- detection of data collisions in the network and reporting them to the terminal equipment as well as indicating them by a LED
- ability to enable/disable the SQE test: at the end of every transmit operation, a short collision signal (heart beat) approx. 1 μ s long is sent to monitor the electronics
- jabber control and display: protecting the network from data packets that are too long (> 20 ms)
- link control and display: continuous monitoring the twisted pair cable segment with link test pulses for short-circuits or idling
- auto polarity exchange (APX) and display: the polarity is reversed automatically if the receiving wire pair is connected incorrectly (RD+ and RD- switched round)

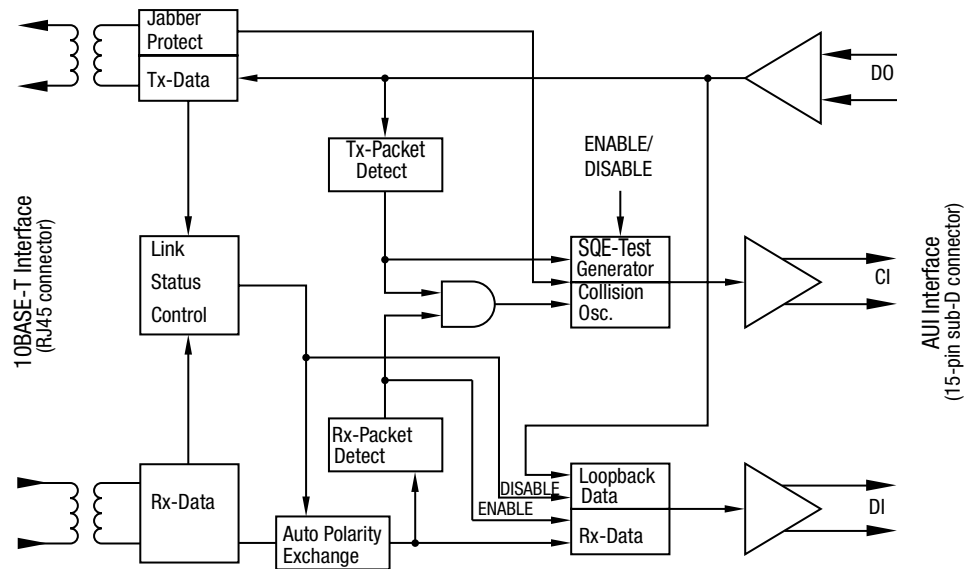

Installation

Link Attenuation

ISO/IEC 8802-3 (10BASE-T) specifies that the link attenuation of a single cable segment must not exceed 11.5 dB at frequencies between 5 and 10 MHz ($Z_L = 100 \Omega$). This value includes

- the attenuation of the twisted pair cable
- connector attenuation
- reflection attenuations as the result of adaption errors of the various components belonging to the single cable segment, e.g., patch panels in which twisted pair cables are connected to each other which, within the scope of the tolerance, have differing characteristic impedance values at the coupling point

Power Supply

The operating voltage (+12 V) is taken from the connected device via the 15-pin Sub-D socket of the AUI interface.

SQE Test

The slide switch on the top of the transceiver case is used to activate and deactivate the SQE test. Before placing the transceiver in operation, you should check to see whether the connected device requires the SQE test to be on or off. As delivered from the factory, the SQE test is on.

Connecting two devices

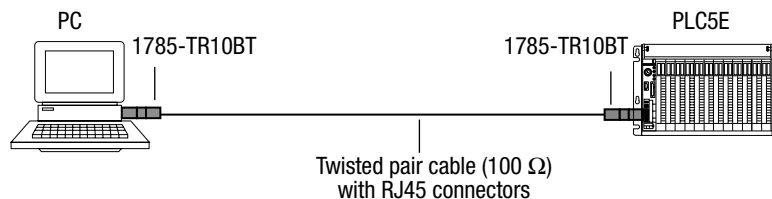

Pin assignments of the RJ45 to RJ45 connecting lead

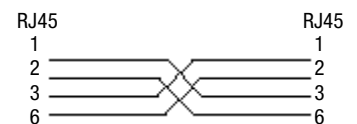

Connecting to an unshielded twisted pair interface card (hub, switch)

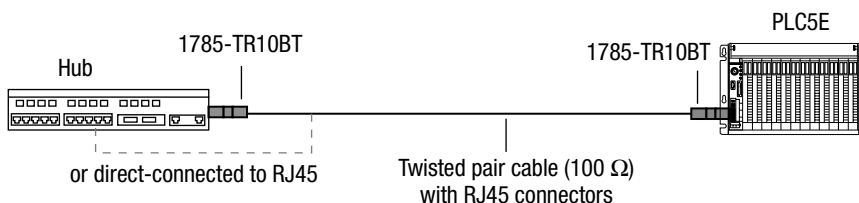

Pin assignments of the RJ45 to RJ45 connecting lead

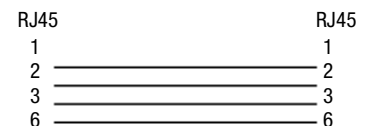

For Additional Information

For standards information, go to <http://www.ieee.org/>. To download a .PDF copy of this publication, go to <http://www.theautomationbookstore.com/>.

Compliance to European Union Directives

If this product has the **CE** marking, it is approved for installation within the European Union and EEA regions. It has been designed and tested to meet the following directives.

EMC Directive

This product is tested to meet Council Directive 89/336/EEC Electromagnetic Compatibility (EMC) and the following standards, in whole or in part, documented in a technical construction file:

- EN 50081-2 EMC - Generic Emission Standard, Part 2 - Industrial Environment
- EN 50082-2 EMC - Generic Immunity Standard, Part 2 - Industrial Environment

This product is intended for use in an industrial environment.

Low Voltage Directive

This product is tested to meet Council Directive 73/23/EEC Low Voltage, by applying the safety requirements of EN 60950 - Information Technology Equipment.

For specific information required by EN 60950, see the appropriate sections in this publication, as well as the following Allen-Bradley publications:

- Industrial Automation Wiring and Grounding Guidelines for Noise Immunity, publication 1770-4.1
- Automation Systems Catalog, publication B111

Hazardous Location Approval

This product may be certified for general use as well as for use in hazardous locations. **Actual agency certification is indicated by the product label** as shown below, and not by statements in any user documentation.

Example of the certification product label:

CL I, DIV 2
GP A,B,C,D
TEMP



To comply with certification for use in hazardous locations, the following information becomes a part of the product literature for this certified industrial control product.

- This equipment is suitable for use in Class I, Division 2, Groups A, B, C, D, or non-hazardous locations only.
- The products having the appropriate markings (that is, Class I, Division 2, Groups A, B, C, D) are certified for use in other equipment where the suitability of combination (that is, application or use) is determined by the local authority having jurisdiction.

Important: Due to the modular nature of a programmable control system, the product with the highest temperature rating determines the overall temperature code rating of a programmable control system in a Class I, Division 2, location. The temperature code rating is marked on the product label as shown.

Temperature code rating:

CL I, DIV 2
GP A,B,C,D
TEMP



Look for temperature
code rating here.

The following warnings apply to products having certification for use in hazardous locations.



ATTENTION: Explosion hazard -

- Substitution of components may impair suitability for Class I, Division 2.
- Do not replace components unless power has been switched off or the area is known to be non-hazardous.
- Do not disconnect equipment unless power has been switched off or the area is known to be non-hazardous.
- Do not disconnect connectors unless power has been switched off or the area is known to be non-hazardous. Secure any user-supplied connectors that mate to external circuits on this equipment by using screws, sliding latches, threaded connectors, or other means such that any connection can withstand a 15 Newton (3.4 lb.) separating force applied for a minimum of one minute.

Approbation d'utilisation en environnements dangereux

Ce produit est certifié pour une utilisation générale aussi bien que pour une utilisation en environnements dangereux. **La certification en vigueur est indiquée par l'étiquette produit** et non par des indications dans la documentation utilisateur.

Exemple d'étiquette de certification d'un produit :

CL I, DIV 2
GP A,B,C,D
TEMP

Pour satisfaire à la certification en environnements dangereux, les informations suivantes font partie intégrante de la documentation des produits de commande industrielle certifiés.

- Cet équipement ne convient qu'à une utilisation en environnements de Classe 1, Division 2, Groupes A, B, C, D, ou non dangereux.
- Les produits portant le marquage approprié (c'est-à-dire, Classe 1, Division 2, Groupes A, B, C, D) sont certifiés pour une utilisation avec d'autres équipements, les combinaisons d'applications et d'utilisation étant déterminées par le bureau local d'inspection qualifié.

Important : De par la nature modulaire des systèmes de commande programmables, le produit ayant le code de température le plus élevé détermine le code de température global du système dans un environnement de Classe 1, Division 2. Le code de température est indiqué sur l'étiquette produit.

Code de température :

CL I, DIV 2
GP A,B,C,D
TEMP

Le code de température
est indiqué ici

Les avertissements suivants s'appliquent aux produits certifiés pour une utilisation en environnements dangereux.





DANGER : Risque d'explosion

- La substitution de composants peut rendre cet équipement inadapté à une utilisation en environnement de Classe 1, Division 2.
- Couper le courant ou s'assurer que l'environnement est classé non dangereux avant de remplacer des composants.
- Couper le courant ou s'assurer que l'environnement est classé non dangereux avant de débrancher l'équipement.
- Couper le courant ou s'assurer que l'environnement est classé non dangereux avant de débrancher les connecteurs. Fixer tous les connecteurs fournis par l'utilisateur pour se brancher aux circuits externes de cet équipement à l'aide de vis, loquets coulissants, connecteurs filetés ou autres, de sorte que les connexions résistent à une force de séparation de 15 newtons (1,5 kg - 3,4 lb) appliquée pendant au moins une minute.

Technical Data

Operating voltage	+10 V to +16 V
Current consumption (no signal)	50 mA (+12 V)
Bit rate (Manchester Code)	10 Mbit/s
Dimensions W x H x D	45 mm x 21 mm x 81 mm (1.8 in. x .83 in. x 3.2 in.)
Weight	100 g (0.22 lb.)
Ambient temperature	0° C to +50° C
Storage temperature	-20° C to +80° C
Relative humidity	10 % to 90 % (non-condensing)
Twisted pair cable interface: Transmitter	
Output signal on 100 Ω	5,4 VPP
Preamble loss transmit	1 bit
Steady State Delay	75 ns typ.
Jabber time out	80 ms
Jabber reset	500 ms
Twisted pair cable interface: Receiver	
Input resistance	100 Ω at 5 MHz
Sensitivity	800 mVPP
Preamble loss receive	3 bit
Steady State Delay	75 ns typ.
Collision recognition time (Data in \rightarrow SQE out)	300 ns
Transceiver interface (AUI)	
Input:	
Terminator	78 Ω \pm 1%
Sensitivity	400 mVPP
Maximum DC component	\pm 50 V
Output:	
Output voltage (Data and CD signal)	1,4 VPP
Frequency CD signal	10 MHz \pm 10%
SQE test (heart-beat)	switchable on/off
Delay time	1000 ns
Length	1000 ns
AUI cable length	0 to 50 m max.
Insulation voltage	
Transceiver interface/twisted pair cable compliance with IEEE 802.3 10BASE-T	1500 V ac from 50 to 60 Hz for 60 seconds 2250 V dc for 60 seconds
Pin assignment	
Twisted pair interface (RJ45 socket)	Transmit: TD+: Pin 1; TD-: Pin 2 Receive: RD+: Pin 3; RD-: Pin 6
Transceiver interface (15-pin sub-D plug)	Transmit: DO+: Pin 3; DO-: Pin 10 Receive: DI+: Pin 5; DI-: Pin 12 Collision detect: CI+: Pin 2; CI-: Pin 9 Power: GND: Pin 6; +12 V: Pin 13 Shield: Pin 1, 4, 8, 11, 14

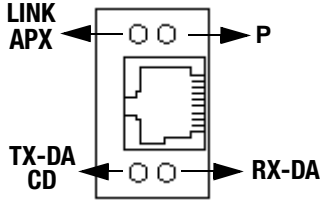
Allen-Bradley Drives

Connections	
Transceiver interface	15-pin sub-D plug
Twisted pair interface	8-pin shielded RJ45 socket
Connections capabilities	
Transceiver interface	plugged directly onto the AUI interface of connected device or connected by an AUI cable (50 m max. length)
Twisted pair interface	unshielded or shielded twisted pair cable segment
Line attenuation	² 11,5 dB at 5-10 MHz (ZL = 100 Ω)
Displays	
	* green LED: P (Power) on – supply voltage present
	* green/red LED: Link/APX off – Link status error green – Link status ok ret – Link status ok but polarity error, automatically switched round of the polarity
	* yellow/red LED: TX-DA/CD yellow – transmitting data into the twisted pair cable red, shortly on – Collision red, continuous on – Jabber Control active
	* yellow LED: RX-DA (Data) on – receiving data from twisted pair cable
Conductors/Wire Size/Category	Category 2 ¹
Agency Certification (when product is marked)	<ul style="list-style-type: none"> c  us • Information Technology Equipment • Industrial Control Equipment • Class I, Div. 2, Groups A, B, C, D Hazardous Location <ul style="list-style-type: none"> CE • EN 50082-1, 2 • EN 55022, Radiated Emission Class B • EN 60950 FCC Part 15, SubPart B

¹ Refer to the Industrial Automation Wiring and Grounding Guidelines for Noise Immunity, publication 1770-4.1.

Reach us now at www.rockwellautomation.com

Wherever you need us, Rockwell Automation brings together leading brands in industrial automation including Allen-Bradley controls, Reliance Electric power transmission products, Dodge mechanical power transmission components, and Rockwell Software. Rockwell Automation's unique, flexible approach to helping customers achieve a competitive advantage is supported by thousands of authorized partners, distributors and system integrators around the world.

Americas Headquarters, 1201 South Second Street, Milwaukee, WI 53204, USA, Tel: (1) 414 382-2000, Fax: (1) 414 382-4444
European Headquarters SA/NV, avenue Herrmann Debroux, 46, 1160 Brussels, Belgium, Tel: (32) 2 663 06 00, Fax: (32) 2 663 06 40
Asia Pacific Headquarters, 27/F Citicorp Centre, 18 Whitfield Road, Causeway Bay, Hong Kong, Tel: (852) 2887 4788, Fax: (852) 2508 1846

Publication 1785-5.20 - January 1999



Rockwell Automation

PN 955134-74

Copyright 1999 of Rockwell International Corporation. Printed in the U.S.A.