

1788-MCHKR MediaChecker

Introduction

The Allen-Bradley 1788-MCHKR MediaChecker (hereafter “the MediaChecker”) is a battery operated, handheld instrument that identifies cable failures, measures length, and checks wiring in the following industrial commercial network cables:

ControlNet™ cables:

- RG-6
- RG-6F (high-flex RG-6)
- DS3/4

DeviceNet™ cables:

- Thick
- Thin
- KwikLink™

DH+/RIO cables:

- 1770-CD
- 9022
- 9463

Ethernet cables:

- Unshielded twisted pair (UTP)
- Foil-screened unshielded twisted pair (FTP)

The MediaChecker is designed around a “Test as You Go” philosophy. This reduces the time necessary to install and service industrial commercial network cables by allowing ONE PERSON to detect most cable failures from only one end of the cable.

The MediaChecker tests for incorrect pairing (split pairs), miswires, and shorted and open wires on all twisted pair cables, as well as shorts on coaxial cables. A stored cable library provides quick access to common cable types. The MediaChecker has most of the functions necessary to verify the proper termination of a wide variety of Rockwell Automation's industrial commercial cables.

The MediaChecker comes with the following:

- 1 Carrying case
- 1 RA (Resistive Adapter) cable identifier with female DB9 connector
- Interface cables and adapters
- 1 *1788-MCHKR MediaChecker Users Manual*
- 1 Quick Reference Card
- 2 AA 1.5 V alkaline batteries

Safety Information

This manual uses the following types of notes to help you use the MediaChecker safely and effectively:



ATTENTION: Identifies information about practices or circumstances that can lead to personal injury or death, property damage, or economic loss.

Important: Identifies information that is critical for successful application and understanding of the product.

The international electrical symbols used on the instrument or in this manual are described in Table 1.

Table 1. International Electrical Symbols

| | |
|--|--|
| | ATTENTION: Risk of damage or destruction to equipment or software. See explanations marked with this symbol in the manual. |
| | Equipment is protected by double insulation or reinforced insulation to protect the user against electric shock. |
| | Do not connect this terminal to public communications networks, such as telephone systems. |
| | Conforms to relevant European Union Directives. |
| | Conforms to relevant Canadian and US Standards. |
| | Conforms to relevant Australian standards. |



ATTENTION: To avoid possible fire, electric shock, personal injury, or damage to the MediaChecker:

- Do not connect the MediaChecker to any telephony inputs, systems, or equipment, including ISDN. Doing so is a misapplication of this product, which can result in damage to the instrument and create a potential shock hazard to the user.
- Do not connect the MediaChecker to active inputs, systems, or equipment. Doing so is a misapplication of this product, which can result in damage to the instrument and create a potential shock hazard to the user. Disable network power sources and all communication nodes before connecting the MediaChecker.
- Do not apply more than 25 V dc to any MediaChecker input. Use caution when connecting the MediaChecker to a network, as voltages greater than 25 V dc may be present on nearby conductors.
- Always turn on the MediaChecker before connecting it to a cable. Turning the MediaChecker on activates the tool's input protection circuitry.
- Do not open the MediaChecker's case (except to replace the batteries). No user-serviceable parts are inside.
- To avoid false test results, replace the batteries as soon as "LOW BATTERY" appears in the display.
- Use only batteries recommended by the manufacturer.
- Do not use the MediaChecker if it is damaged. Protection may be impaired. Inspect the MediaChecker for physical damage before each use.
- Do not attempt to insert any connector other than an RJ45 connector into the RJ45 jack. Inserting other connectors, such as RJ11 (telephone) connectors, can permanently damage the jack.
- Do not operate portable transmitting devices during a cable test. Doing so might cause erroneous test results.
- To avoid false test results, do not run cable tests with cables attached to more than one connector on the MediaChecker or with network equipment attached to the cable under test.

Getting Acquainted

Display, Switches, and Connections

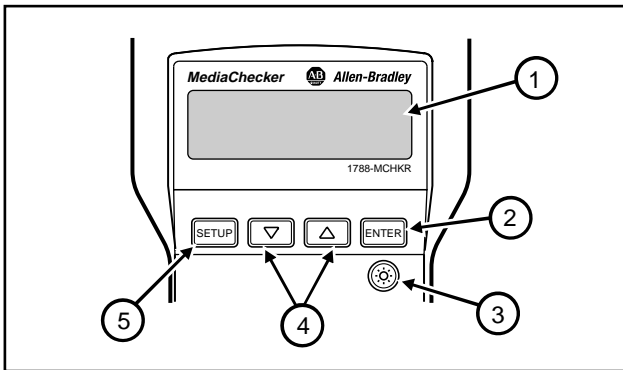





Figure 1. Front Panel Features

aan01f.eps

Table 2. Features

| Item | Function |
|------|--|
| ① | <p>LCD A 2-line by 16-character LCD display. When there is more information than can be displayed on two lines, an up arrow \uparrow, down arrow \downarrow, or bidirectional arrow \leftrightarrow appears in the left side of the display. Press the corresponding \uparrow or \downarrow key to display the additional information.</p> |
| ② | <p>ENTER Enters a selection into the MediaChecker and moves to the next setup selection. Causes current cable selection to be displayed and a new measurement cycle initiated when not in Setup Mode.</p> |
| ③ | <p> Turns the display backlight on or off. Backlighting turns off automatically after 60 seconds.</p> |
| ④ | <p>  Scrolls through a selection of choices or multiple displays.</p> |
| ⑤ | <p>SETUP Provides access to cable selection, calibration, and other MediaChecker settings.</p> |

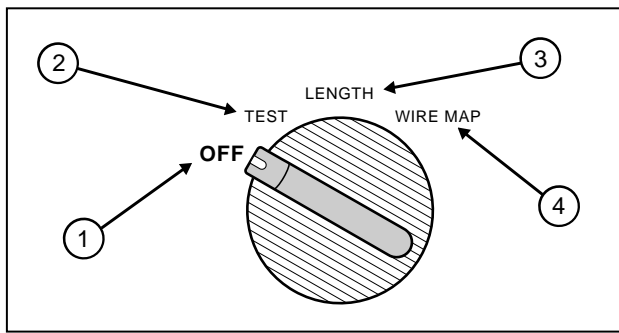

Figure 2. Rotary Switch

aan02f.eps

Table 3. Rotary Switch Positions

| Item | Description |
|------|--|
| ① | Turns the MediaChecker off. See “Battery Save Mode” for more information. |
| ② | Tests the attached cable and provides a pass or fail summary based on the parameters specified for the selected cable. |
| ③ | Displays the length of the attached cable in feet or meters and tests for anomalies. |
| ④ | Displays wiring connections, shorts, opens, and split pairs. |

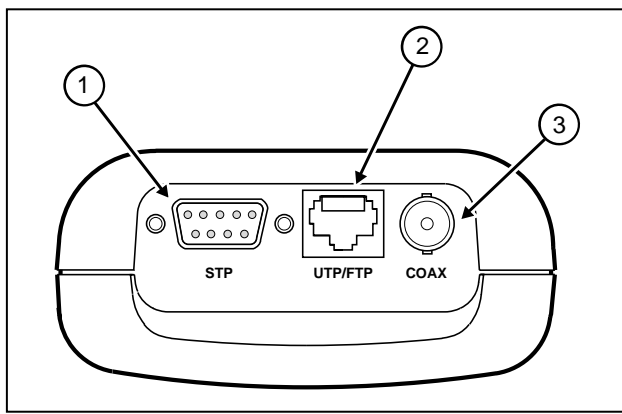

Figure 3. Connections

aan03f.eps

Table 4. Connections

| Item | Description |
|------|---|
| ① | Standard 9-pin (DB9) connector for connecting DeviceNet and DH+/RIO cables (using the adapter provided). |
| ② | Standard 8-pin modular jack for connecting unshielded (UTP) and foil-screened (FTP) unshielded twisted pair cable for Ethernet IEEE 802.3 networks. |
| ③ | BNC connector for connecting ControlNet cables. |

Audible Signal (Beeper)

The MediaChecker's beeper indicates various conditions:

- A single, short tone indicates a pass condition without the Cable ID detected.
- A two-frequency tone indicates a pass condition with the Cable ID detected.
- Three short tones indicate a test failure.
- A long tone sounds whenever an invalid key is pressed.

- A continuous, varying-pitch tone indicates the MediaChecker is connected to an active cable and should be disconnected immediately. "ACTIVE CABLE" is displayed.

To disable the audible signal for the "PASS" and "FAIL" conditions, see "Setup Selections" on page 35. The tone that indicates an active cable cannot be disabled.

Low Battery Indication

When the battery voltage is low but it is OK to continue, the MediaChecker displays "LOW BATTERY" once during power-up. When this message first appears there are about 8 hours of use left. When the battery voltage is too low to continue, the unit displays "REPLACE BATTERY". To continue using the MediaChecker, you must replace the batteries. Refer to "Replacing Batteries" on page 36.

Battery Save Mode

The MediaChecker turns itself off when there is no switch or key activity for 10 minutes. To return the MediaChecker to operation, you must turn the rotary switch to OFF and wait 5 seconds before turning the MediaChecker back on.

To disable the Battery Save feature, turn the rotary switch to OFF, then press and hold **ENTER** while turning the rotary switch to TEST. To re-enable the Battery Save feature, turn the MediaChecker off, then on again.

Cable ID Unit

The Cable ID lets you detect wiring failures on twisted pair cable. Test results can vary depending on whether the ID unit is connected or not. See Table 7 on page 14 and "Twisted Pair Cable Test Results" on page 15 for more information.

Selecting the Display Language

The MediaChecker displays messages in English, French, German, Spanish, and Japanese. To change the display language, do the following:

1. With the MediaChecker off, press and hold **SETUP** while turning the rotary switch to TEST.
2. Press **▲** or **▼** until the desired language is displayed, then press **SETUP**.

Preparing the MediaChecker for Use



ATTENTION: To reduce wear on the MediaChecker connector, leave the adapter connected to the MediaChecker whenever possible.

Plugging a 4 or 6 position plug into the MediaChecker's UTP/FTP jack can permanently damage the jack pins.

Important: The noise filter should be set to the frequency of the local power mains (50 Hz or 60 Hz). See "Setup Selections" on page 35 for this and other customizing selections.

After connecting the cable under test to the appropriate connector on top of the MediaChecker, you must select proper cable type, category, and size before testing or measuring. It may also be necessary to calibrate the MediaChecker to the cable under test. See "Calibrating the MediaChecker to a Cable" on page 10.

Important: Never run cable tests with more than one cable connected to the MediaChecker. Doing so can cause erroneous results.

If you think the MediaChecker is not performing properly, refer to "When Something Goes Wrong" on page 36.

Selecting a Cable Type

Characteristics for a variety of Rockwell Automation's industrial commercial network cables are stored in the MediaChecker and can be accessed through SETUP. See Table 5.

Table 5. Predefined Cable List

| ControlNet (CNET) | DeviceNet (DNET) | DH+ /RIO | Ethernet (ENET) |
|------------------------------|-----------------------------|-----------------|----------------------------|
| RG6 | Thick | 1770-CD | UTP |
| RG6F | Thin | 9022 | FTP |
| DS3/4 | KwikLink | 9463 | |

To set up the MediaChecker for the desired cable, do the following:

Important: The number of steps necessary to select a cable definition depends on the type of network selected.

1. Turn the MediaChecker on by turning the rotary switch to TEST, LENGTH, or WIRE MAP.
2. Press **SETUP**.
3. Press **▲** or **▼** until the desired network is displayed, then press **ENTER**.
4. Press **▲** or **▼** until the desired cable type is displayed, then press **ENTER**.

Steps 5 and 6 apply only to Ethernet:

5. Press **▲** or **▼** until the desired category is displayed, then press **ENTER**.
6. Press **▲** or **▼** until the desired wire size is displayed, then press **ENTER**.
7. Press **SETUP** or turn the rotary switch to a new position to exit the setup menu.

Important: You can check the cable selection at any time other than when in the setup mode by pressing the **ENTER** key.

The MediaChecker will now test according to the cable characteristics defined by the factory settings for the cable selected. However, cables coming from different batches or manufacturers can have characteristic variances of up to 20 %, causing deviations in length measurements. For more accurate measurements, calibrate the MediaChecker to a known length of the cable to be tested. See “Calibrating the MediaChecker to a Cable” on page 10.

Calibrating the MediaChecker to a Cable

Cables from different batches or manufacturers can have characteristic variances of up to 20 %, causing deviations in length measurements. To ensure maximum accuracy of length measurements, calibrate the MediaChecker to a known length of the cable to be tested.

Important: The MediaChecker is calibrated at the factory to provide length measurements that are accurate enough for most applications. In most cases, you will not need to calibrate the MediaChecker to a specific cable.

When you calibrate the MediaChecker to a specific cable, use a known length of cable at least 100 ft (30 m) long and of the same type and category as the cable under test. Calibrating with cables longer than 100 ft (30 m) will improve the accuracy of length measurements.

During the calibration process, if the cable is found to be defective or if the cable is less than 50 ft (15 m) long, "BAD CABLE" is displayed and the calibration process is terminated.

Important: To ensure accurate measurements, be sure that conductive objects, including fingers, do not touch any of the cable connectors or conductors during calibration or cable tests.

To calibrate the MediaChecker to the currently selected cable, do the following:

1. Connect a good cable of known length, 100 ft (30 m) or longer, to the appropriate MediaChecker connector.

Important: If you have just finished selecting a cable type, the MediaChecker should already show the calibration selection display shown below. In this case, read the **Important** note after step 3; then continue the calibration process with step 4. Otherwise, continue with step 2.

2. Turn the rotary switch to TEST, LENGTH, or WIRE MAP.
3. Press **SETUP**; then press **ENTER** repeatedly until the following display appears:
4. Press **▲** **▼** until "YES" appears, and then press **ENTER**. The MediaChecker takes a few measurements on the attached cable and displays the measured length.

```

CAL TO CABLE?
#NO          ENTER
    
```

aan06f.eps

```

ADJUST LENGTH:
#98'          ENTER
    
```

aan07f.eps

Important: If the MediaChecker has already been calibrated to the selected cable type, "CAL" appears on the second line of the second display shown at power-up. This display appears for about 3 seconds before testing begins. To erase this calibration and use the factory settings, remove all cables from the MediaChecker, press **▲** **▼** until "YES" appears; then press **ENTER**.

Press **ENTER** anytime (except in setup mode) to see the calibration status for the currently selected cable.

5. Press **▲** **▼** until the display shows the known cable length, and then press **ENTER**.

These cable parameters are stored and remain in memory even if the MediaChecker is turned off. All future measurements for this cable type are compared to the new parameters until you perform a new calibration for the cable type.

Key to Twisted Pair Displays

Table 6 describes the symbols used for DeviceNet, DH+/RIO, and Ethernet displays.

Table 6. Key to Twisted Pair Displays

| | | |
|-----------------------|---|------------------------|
| ID-- | No Cable ID detected | |
| IDRA | Cable ID detected | |
| ID?? IDRA | “??” alternates with “RA”. Cable ID partially detected. There is a problem with the cable or ID unit. | |
| DeviceNet Wire | Display | Clip/Wire Color |
| V + | + | Red |
| CAN_H | H | White |
| Shield | S | Bare |
| CAN_L | L | Blue |
| V - | - | Black |

Table 6. Key to Twisted Pair Displays (cont.)

| DH+/RIO Wire | Phoenix Pin | Display | Clip Color | RIO Color | DH+ Color |
|----------------------|-------------|----------------|----------------------|-----------|-----------|
| Line 1 | 1 | 1 | Blue | Blue | Clear |
| Shield | 2 | S | Bare | Bare | Bare |
| Line 2 | 3 | 2 | White | Clear | Blue |
| Ethernet 568A | | Display | Wire Color | | |
| Pair 1: 4, 5 | | 4 5 | Blue, White/blue | | |
| Pair 2: 3, 6 | | 3 6 | White/orange, Orange | | |
| Pair 3: 1, 2 | | 1 2 | White/green, Green | | |
| Pair 4: 7, 8 | | 7 8 | White/brown, Brown | | |
| Ethernet 568B | | Display | Wire Color | | |
| Pair 1: 4, 5 | | 4 5 | Blue, White/blue | | |
| Pair 2: 1, 2 | | 1 2 | White/orange, Orange | | |
| Pair 3: 3, 6 | | 3 6 | White/green, Green | | |
| Pair 4: 7, 8 | | 7 8 | White/brown, Brown | | |

The Test Function (TEST)

The TEST function tests the attached cable and indicates “PASS” or “FAIL” based on the cable’s compliance with the parameters stored in the MediaChecker for the selected cable. The tests that are performed (Table 7) depend on whether or not a Cable ID is connected to the far end of the cable.

To test only the wire map or measure only the cable length, use the WIRE MAP or LENGTH functions. See “Testing the Wire Map” on page 24 or “Measuring Cable Length” on page 27.

To test a cable, do the following:

1. Disconnect all network devices (nodes) and remove the terminator from the far end of the cable to be tested. (For information on calculating the length of a terminated cable, see “Calculating the Distance to a Short” on page 32.)
2. For DeviceNet, DH+/RIO, and Ethernet cables, connect the Cable ID to the far end of the cable, if desired (refer to Table 7).
3. Connect the cable under test to the appropriate connector on the MediaChecker. Use the included adapter for DeviceNet or DH+/RIO cables.
4. Turn the rotary switch to TEST.

You can omit step 5 if you know the cable selection is correct for the cable under test:
5. Press **ENTER** to check the cable selection. The MediaChecker displays the cable selection for a few seconds, then starts the test. If the cable selection is not correct, refer to “Preparing the MediaChecker for Use” on page 8.

“CAL” appears in the second line of the display if a cable calibration has been performed for the selected cable type. See “Calibrating the MediaChecker to a Cable” on page 10 for more information.

Table 7. Failures Detected for Each Cable Type

| Failures Detected | DeviceNet | DH+/RIO | Ethernet | ControlNet |
|--|------------------|------------------|------------------|-------------------|
| Distance to short | Yes ¹ | Yes | Yes | Yes |
| Distance to open (near end) | Yes ¹ | Yes ² | Yes | Yes ² |
| Length | Yes ¹ | Yes | Yes | Yes |
| Split pair | Yes ³ | No | Yes | No |
| Wire map | Yes ⁴ | Yes ⁴ | Yes ⁴ | No |
| <p>1. Measured for the data pair only. For shorted power wires, the MediaChecker displays the resistance of the short. 2. The distance to an open is the same as the measured length. 3. Split pair test not run on KwikLink cables. 4. Test available when using the Cable ID.</p> | | | | |

Twisted Pair Cable Test Results

Important: If you suspect inaccurate length readings, calibrate the MediaChecker to the cable. See “Calibrating the MediaChecker to a Cable” on page 10.

Length measurements show the total length of the trunk plus all drops on the cable. For information on calculating the length of just the trunk, drops, or taps, see “Calculating Trunk, Drop, or Tap Lengths” on page 29.

Twisted pair cables include DeviceNet, DH+/RIO, and Ethernet. When you test twisted pair cables, the MediaChecker checks for the Cable ID at the other end of the cable and displays one of the following when a pass condition exists:

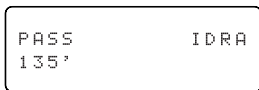

aan09f.eps

“PASS” means the cable is good. “RA” means the Cable ID is detected.



aan59f.eps

“--” means the Cable ID is not detected. If the MediaChecker does not detect a properly connected Cable ID, the cable is probably defective (most likely at the far end).

Tables 8 and 9 show examples of DeviceNet cable failures with and without the Cable ID connected. DH+/RIO and Ethernet displays use the same fault indicators, but show different symbols for the wires. (See Table 6.)

Important: The MediaChecker may not detect the Cable ID under some open and short conditions. The MediaChecker alternately displays “??” and “RA” (for “Resistive Adapter”) when the Cable ID is detected but a problem with the cable or the Cable ID is interfering with the identification process.

Table 8. DeviceNet Test Results (with Cable ID)¹

| Display | Failure | Description |
|--|--|---|
| <pre> FAIL ID?? L&H SHORT 600'</pre> | Short across the data pair ² | "SHORT" is blinking. L and H are shorted together at approximately 600' (183 m). |
| <pre> FAIL IDRA +- SPLIT PR</pre> | Split pair | "SPLIT PR" is blinking. In this case, a power wire and a data wire are swapped at the near end and swapped back at the far end. |
| <pre> FAIL IDRA + OPEN</pre> | Open, or a wire is swapped with the shield | "OPEN" is blinking. This can mean one of the following: <ul style="list-style-type: none"> • The + wire is open somewhere along the cable. • The + and S wires are swapped somewhere along the cable. |
| <p>1. The MediaChecker might not be able to map some situations with four or five wires miswired. In all cases, the MediaChecker indicates a fault and gives a partial description of the problem, but might not identify all of the wiring errors.</p> <p>2. The distance to a short may not be reported, depending on the characteristics of the short. See "Calculating the Distance to a Short" on page 32 for more information.</p> | | |

Table 8. DeviceNet Test Failures (with Cable ID) (cont.)¹

| Display | Failure | Description |
|---|--------------------------|---|
| <pre> FAIL IDRA S&L SHORT </pre> | Short to the shield. | “SHORT” is blinking. There is a resistive fault between S and L. It could be a short or a slightly higher resistance. Check the connectors first; then look for a crushed spot on the cable. You can use an ohmmeter to measure the short’s resistance, then use the information given under “Calculating the Distance to a Short” on page 32 to determine the distance to the short. |
| <pre> FAIL ID?? ▼S&L SHORT ▲L- FAULT <6Ω H OPEN </pre> | Three wires are shorted. | “SHORT”, “FAULT”, and “OPEN” are blinking. ² The L and – wires are shorted to the shield (S). Use the measured resistance (6 Ω in this case) and the information given under “Calculating the Distance to a Short” on page 32 to determine the distance to the short. |

1. The MediaChecker might not be able to map some situations with four or five wires miswired. In all cases, the MediaChecker indicates a fault and gives a partial description of the problem, but might not identify all of the wiring errors.

2. Because some measurements are not possible on faulted cables, the MediaChecker might report the H wire as open when it is not actually open.

Table 9. DeviceNet Test Failures (without Cable ID)

| Display | Failure | Description |
|---|---|---|
| <pre> FAIL ID-- ▼L- FAULT >350Ω ▲H- FAULT >350Ω </pre> | <p>The MediaChecker detects a very high resistance between the data lines and the “-” power line.</p> | <p>“FAULT” and “350Ω” are blinking. There is probably one or more I/O device connected to the cable under test. To determine the cable length, do one of the following:</p> <ul style="list-style-type: none"> • Disconnect the I/O devices and retest the cable. • Install a terminator at the far end of the cable, measure the resistance of the cable in series with the terminator; then calculate the cable length. See “Calculating the Distance to a Short” on page 32. |
| <pre> FAIL ID-- ▼LH FAULT 126Ω ▲+&- OPEN </pre> | <p>The MediaChecker detects a fairly high resistance between the CAN_H and CAN_L (data) wires.</p> | <p>“FAULT” and “OPEN” are blinking.*</p> <p>A terminator is probably connected to one end of the bus. You can subtract the resistance of the terminator (typically 120 Ω) from the measured resistance, then calculate an approximate length using the remaining resistance. See “Calculating the Distance to a Short” on page 32.</p> <p>To determine the cable’s wire map and get a more accurate length measurement, replace the terminator with the Cable ID and run the test again.</p> |
| <p>* Because some measurements are not possible on faulted cables, the MediaChecker might report the + and – wires as open when they are not actually open.</p> | | |

Table 9. DeviceNet Test Failures (without Cable ID) (cont.)

| Display | Failure | Description |
|---|--|---|
| <pre> FAIL ID-- ▼LH FAULT 39Ω ▲+&- OPEN </pre> | <p>The MediaChecker detects a low resistance between the CAN_H and CAN_L (data) wires; however, the resistance is higher than a short circuit.</p> | <p>“FAULT” and “OPEN” are blinking.¹ There is a resistive fault between L and H. The resistance is higher than the resistance of a cable 1640 ft long (500 m), which is the maximum allowable length.</p> |
| <pre> FAIL ID-- ▼LH SHORT 1954' ▲+&- OPEN </pre> | <p>The MediaChecker detects a low resistance between the CAN_H and CAN_L (data) wires.²</p> | <p>“SHORT”, ≤954' (291 m), and “OPEN” are blinking.¹ There is a short between L and H. The MediaChecker displays the most likely distance to the fault. Connect the Cable ID to the far end of the cable and repeat the test to check the + and – wires.</p> |

1. Because some measurements are not possible on faulted cables, the MediaChecker might report the + and – wires as open when they are not actually open.
2. A short greater than zero ohms causes the MediaChecker to display a length greater than the actual distance to the short. See Figure 4 on page 23. The MediaChecker uses ohms/foot to calculate distance to a short.

Table 9. DeviceNet Test Failures (without Cable ID) (cont.)

| Display | Failure | Description |
|---|---|--|
| <pre> FAIL ID-- ▼L OPEN @ 0' ▲+&- OPEN @ 3' </pre> | <p>The MediaChecker measures a very short length for the CAN_L wire as compared to the other wires.</p> | <p>“OPEN” is blinking.* The L wire is open at the near end. To detect an open at the far end, connect the Cable ID to the far end and repeat the test or connect the Cable ID to this end of the cable and repeat the test from the other end.</p> |
| <p>* Because some measurements are not possible on faulted cables, the MediaChecker might report the + and – wires as open when they are not actually open.</p> | | |

Coaxial Cable Test Results

Important: If you suspect inaccurate length readings, calibrate the MediaChecker to the cable. See “Calibrating the MediaChecker to a Cable” on page 10.

Length measurements show the total length of the trunk plus all taps on the cable. For information on calculating the length of just the trunk, drops, or taps, see “Calculating Trunk, Drop, or Tap Lengths” on page 29 or refer to the Quick Reference Card.

When you test coaxial cables (ControlNet) with a terminating resistor connected, the MediaChecker sounds three short tones and displays the total resistance of the terminator and cable wires:



aan10f.eps



Important: Coaxial cables must be unterminated for the MediaChecker to display the cable’s length. An open in a coaxial cable looks just like an unterminated cable. **If you know the cable is longer than the measurement shows, there is probably an open on the cable.**

The MediaChecker sounds three short tones and displays “FAIL” if a failure is detected.

Additional information about a failure is printed on the second line of the display and if the ¶ symbol is displayed, additional information can be viewed with the ▼ ▲ keys.

Table 10 shows examples of ControlNet cable failures.

Table 10. ControlNet Test Failures

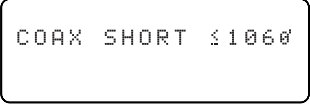
| Display | Failure | Description |
|--|--|--|
|  | The MediaChecker detects a cable length greater than 2130 ft (650 m) ¹ , which is the maximum it can measure. | If “2130” (650 m) ¹ is flashing, the cable is longer than the maximum the MediaChecker can measure. Break the cable near its center and measure the two parts separately. |
|  | The MediaChecker detects a resistance that is greater than the resistance of 2130 ft (650 m) ¹ of cable (about 65 Ω). | A terminator resistor is probably connected to one end of the bus. Remove the terminator; then retest. Or, subtract the terminator’s resistance (75 Ω) from the measured resistance to get the cable resistance. Then use the procedure under “Calculating the Distance to a Short” on page 32 to calculate the cable length. |
|  | The MediaChecker detects a resistance that is less than the resistance of 2130 ft (650 m) ¹ of cable (about 65 Ω). ² | “SHORT” is blinking. A resistance less than 65 Ω (which is too low to be a terminator) is across the line. The display shows the most likely distance to the fault. |
| <ol style="list-style-type: none"> 1. The MediaChecker measures lengths to 650 m; however distances in feet beyond 999 ft are rounded to the nearest 10 ft. 2. A short greater than zero ohms causes the MediaChecker to display a length greater than the actual distance to the short. Figure 4 on page 23 illustrates this process using an Ethernet example. The MediaChecker uses ohms/foot to calculate distance to a short. | | |

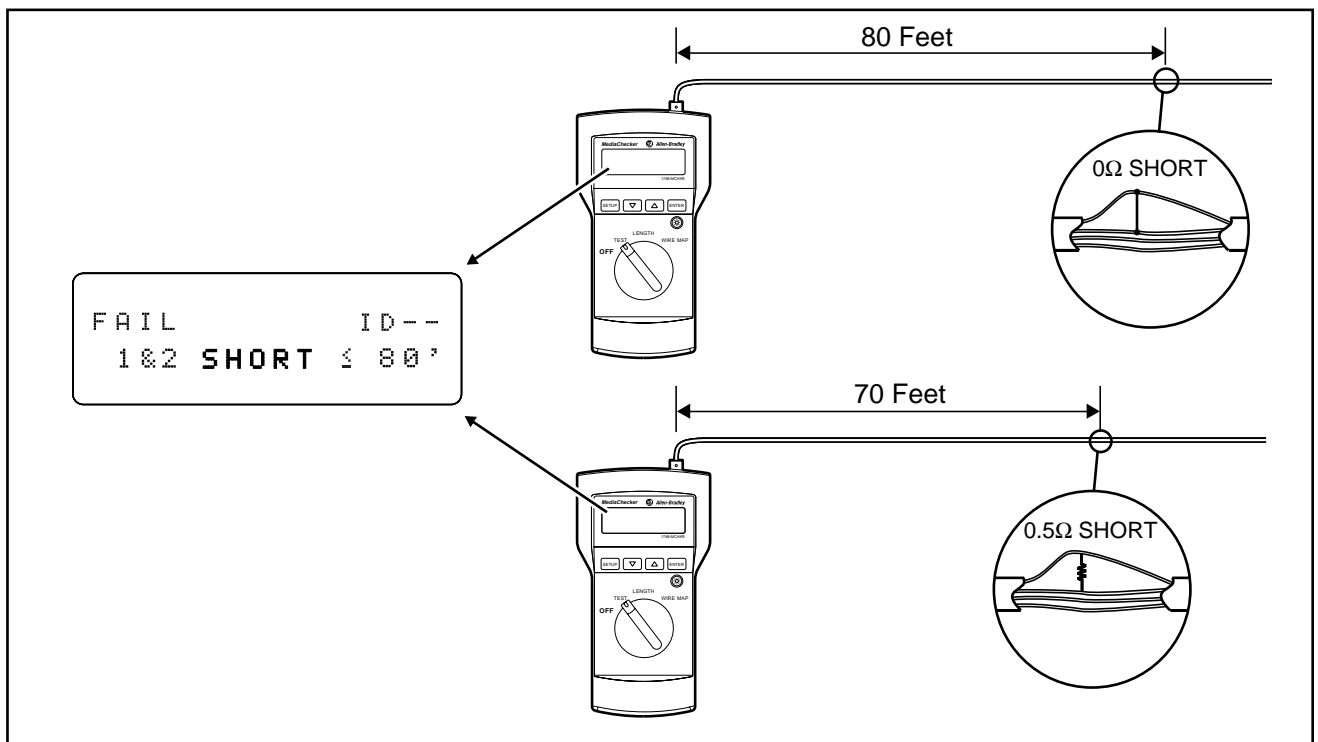

aan04f.eps

Figure 4. Testing for Shorts (Ethernet Example)

Testing the Wire Map (WIRE MAP)

Using the MediaChecker's WIRE MAP function and the Cable ID, you can determine the wiring of both the near and far ends of twisted pair cables. To test the wire map, do the following:

1. Connect the cable under test to the appropriate connector on the MediaChecker.
2. Connect the Cable ID to the far end of the cable. Use an adapter, if necessary.
3. Turn the rotary switch to WIRE MAP.

You can omit step 4 if you know the cable selection is correct for the cable under test.

4. Press **ENTER** to check the cable selection. The MediaChecker displays the cable selection for a few seconds and then starts the test. If the cable selection is not correct, refer to "Preparing the MediaChecker for Use" on page 8 for instructions on selecting a new cable setting. "CAL" appears in the second line of the display if a cable calibration has been performed for the selected cable type.

Important: If you select the "COAX" cable type while in the WIRE MAP mode, the MediaChecker will perform the LENGTH test on the cable.

Assuming the cable attached to the MediaChecker is a DeviceNet Thick cable with no failures, the following display indicates a good cable:

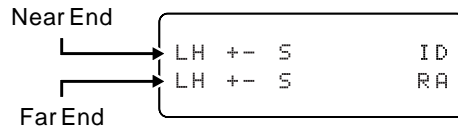

aan13f.eps

The top line always displays the near end of the cable; the second line always displays the far end.

When the MediaChecker detects something on the far end of the cable, but cannot determine if it is the Cable ID, "ID" is displayed. The MediaChecker alternately displays "??" and "RA" when the Cable ID is detected but a problem with the cable or with the Cable ID is interfering with the identification process.

Without the Cable ID connected to the far end of the cable, the MediaChecker displays "--".

The following display indicates the near end wiring of a cable without the Cable ID connected:

```
LH +- S      ID
                --
```

aan14f.eps

Table 11 shows example of wire map failures on DeviceNet cable.

Table 11. DeviceNet Wire Map Failures (with Cable ID)

| Display | Failure | Description |
|---|--|---|
| <pre>LH +- S ID L+ H- S RA</pre> | Miswire (wires are swapped) | "H" and "+" are blinking. The first line on the display (LH +- S) shows the near end connections. The second line (L+ H- S) shows far end connections. This mapping shows that the H and + wires are swapped. |
| <pre>SL +- H ID ss RA</pre> | Short | The S and L wires are shorted together. |
| <pre>LH +- S ID LH o- S RA</pre> | Open, or a wire is swapped with the shield | "o" is blinking in the bottom line. The "+" wire is open at the far end or is swapped with the shield (S). |
| <pre>SL L- +H ID ss ??</pre> | Multiple shorts* | "ss", "L-", and "o" are blinking. "ss" blinking indicates a short from L to S. "L-" blinking indicates a fault between the L and - wires. Use TEST or LENGTH to check the resistance between the wires. |
| <pre>LH +- S ID LH +- S RA</pre> | Split pair | If nothing is blinking, the connection is good. If part of the display is blinking (for example, "+-" in both rows), there is a split pair, or a fault that the MediaChecker cannot clearly identify because the fault interferes with testing. |
| * The MediaChecker alternately displays "???" and "RA" when the Cable ID is detected, but a problem with the cable or with the Cable ID is interfering with the identification process. | | |

Measuring Cable Length (LENGTH)

Important: If you suspect inaccurate length readings, calibrate the MediaChecker to the cable. See “Calibrating the MediaChecker to a Cable” on page 10.

Length measurements show the total length of the trunk plus all drops or taps on the cable. For information on calculating the length of just the trunk, drops, or taps, see “Calculating Trunk, Drop, or Tap Lengths” on page 29.

Using the MediaChecker's LENGTH function, you can measure the length of both twisted-pair and coaxial cables. If the MediaChecker is not calibrated to the cable under test, the factory defaults are used to compute the length. If you require more accurate length measurements, refer to “Calibrating the MediaChecker to a Cable” described on page 10.

Before a length measurement is made, the MediaChecker performs diagnostic tests to prevent any cable failures from corrupting the length measurement. All failures are described in the earlier sections “The TEST Function” and “Testing the Wire Map”.

To measure the length of a cable, do the following:

1. Disconnect all network equipment and remove the terminator from the far end of the cable to be tested. (For information on calculating the length of a terminated cable, see “Calculating the Distance to a Short” on page 32.)
2. Connect the cable under test to the appropriate connector on the MediaChecker.
3. Turn the rotary switch to LENGTH.

You can omit step 4 if you know that the cable selection is correct for the cable under test.

28 Measuring Cable Length (LENGTH)

4. Press **ENTER** to check the cable selection.

The MediaChecker displays the cable selection for a few seconds and then starts the test. If the cable selection is not correct, refer to "Preparing the MediaChecker for Use" on page 8 to select a new cable setting. "CAL" appears in the second line of the display if a cable calibration has been performed for the selected cable type.

Important: When a length measurement flashes on the display, the length of the cable exceeds either the maximum allowed by the standard (for DeviceNet, DH+/RIO, and Ethernet cables) or the MediaChecker's range of measurement (for ControlNet cables).

The information displayed depends on the type of cable selected.

For a DeviceNet cable with no failures, the display shows the following:



```
LH          305'  
++-
```



```
+S
```

aan11f.eps

The MediaChecker cannot determine the length of a coaxial cable terminated with a resistance. Only the total resistance of the wire and the terminator is displayed. An unterminated coaxial cable 445 ft long gives the following result:



```
COAX          445'
```

aan12f.e

Calculating Trunk, Drop, or Tap Lengths

When you test a cable that has drops or taps, the MediaChecker reports the length of the trunk, plus the total length of all the drops or taps on the trunk.

This section shows how to calculate the length of just the trunk or the total length of just the drops or taps.

DeviceNet and DH+/RIO Length Calculations

Formulas:

Measure drop lengths with the MediaChecker or a tape measure.

- Trunk length = Measured length – Total actual length of drops
- Total drop length = Measured length – Trunk length

Example 1: Calculating trunk length

A cable measures 270 ft long. The cable has 2 drops of 15 ft each.

Trunk length = 270 ft measured length – 30 ft drop length = 240 ft trunk length

Example 2: Calculating total drop length

A cable measures 788 ft long. The trunk is 400 ft long.

Total length of drops = 788 ft measured length – 400 ft trunk length = 388 ft total drop length

ControlNet Length Calculations

Measured tap lengths depend on whether the taps are terminated or not. See Table 12.

Formulas:

- Trunk length = Measured length – Total measured length of taps
- Total tap length = Measured length – Trunk length

Example 1: Calculating trunk length

A cable measures 750 ft long and has 16 unterminated taps.

From Table 12, 16 unterminated taps = 69 measured ft

Trunk length = 750 ft measured length – 69 ft tap length = 681 ft trunk length

Example 2: Calculating total tap length and the number of taps

A cable measures 328 m long. The actual cable length is 274 m. The taps on the cable are terminated.

Measured (terminated) total tap length = 328 m – 274 m = 54 m

From Table 12, 54 meters of terminated taps corresponds to 23 taps.

Table 12. Measured Tap Lengths for ControlNet Cables

| Number of Taps | Terminated Tap* | Unterminated Tap |
|----------------|-----------------|------------------|
| 1 | 8 ft (2.5 m) | 4 ft (1.5 m) |
| 2 | 16 ft (5 m) | 9 ft (2.5 m) |
| 3 | 23 ft (7 m) | 13 ft (4 m) |
| 4 | 31 ft (9.5 m) | 17 ft (5 m) |
| 5 | 39 ft (12 m) | 22 ft (6.5 m) |
| 6 | 47 ft (14.5 m) | 26 ft (8 m) |
| 7 | 55 ft (16.5 m) | 30 ft (9 m) |
| 8 | 62 ft (19 m) | 34 ft (10.5 m) |
| 9 | 70 ft (21.5 m) | 39 ft (12 m) |
| 10 | 78 ft (24 m) | 43 ft (13 m) |
| 11 | 86 ft (26 m) | 47 ft (14.5 m) |
| 12 | 94 ft (28.5 m) | 52 ft (15.5 m) |
| 13 | 101 ft (31 m) | 56 ft (17 m) |
| 14 | 109 ft (33.5 m) | 60 ft (18.5 m) |
| 15 | 117 ft (35.5 m) | 65 ft (19.5 m) |
| 16 | 125 ft (38 m) | 69 ft (21 m) |
| 17 | 133 ft (40.5 m) | 73 ft (22.5 m) |

| Number of Taps | Terminated Tap* | Unterminated Tap |
|----------------|-----------------|------------------|
| 18 | 140 ft (43 m) | 77 ft (23.5 m) |
| 19 | 148 ft (45 m) | 82 ft (25 m) |
| 20 | 156 ft (47.5 m) | 86 ft (26 m) |
| 21 | 164 ft (50 m) | 90 ft (27.5 m) |
| 22 | 172 ft (52.5 m) | 95 ft (29 m) |
| 23 | 179 ft (54.5 m) | 99 ft (30 m) |
| 24 | 187 ft (57 m) | 103 ft (31.5 m) |
| 25 | 195 ft (59.5 m) | 108 ft (33 m) |
| 26 | 203 ft (62 m) | 112 ft (34 m) |
| 27 | 211 ft (64 m) | 116 ft (35.5 m) |
| 28 | 218 ft (66.5 m) | 120 ft (36.5 m) |
| 29 | 226 ft (69 m) | 125 ft (38 m) |
| 30 | 234 ft (71.5 m) | 129 ft (39.5 m) |
| 31 | 242 ft (73.5 m) | 133 ft (40.5 m) |
| 32 | 250 ft (76 m) | 138 ft (42 m) |
| 33 | 257 ft (78.5 m) | 142 ft (43 m) |
| 34 | 265 ft (81 m) | 146 ft (44.5 m) |
| 35 | 273 ft (83 m) | 151 ft (46 m) |

* Terminated with 1786/1797-TCAP

Table 12. Measured Tap Lengths for ControlNet Cables (cont.)

| Number of Taps | Terminated Tap* | Unterminated Tap |
|----------------------------------|------------------------|-------------------------|
| 36 | 281 ft (85.5 m) | 155 ft (47 m) |
| 37 | 289 ft (88 m) | 159 ft (48.5 m) |
| 38 | 296 ft (90.5 m) | 163 ft (50 m) |
| 39 | 304 ft (92.5 m) | 168 ft (51 m) |
| 40 | 312 ft (95 m) | 172 ft (52.5 m) |
| 41 | 320 ft (97.5 m) | 176 ft (53.5 m) |
| 42 | 328 ft (100 m) | 181 ft (55 m) |
| 43 | 335 ft (102 m) | 185 ft (56.5 m) |
| 44 | 343 ft (104.5 m) | 189 ft (57.5 m) |
| 45 | 351 ft (107 m) | 194 ft (59 m) |
| 46 | 359 ft (109.5 m) | 198 ft (60.5 m) |
| 47 | 367 ft (111.5 m) | 202 ft (61.5 m) |
| 48 | 374 ft (114 m) | 206 ft (63 m) |
| * Terminated with 1786/1797-TCAP | | |

Calculating the Distance to a Short

Depending on the type of short on a cable, the MediaChecker may or may not be able to determine the distance to the short. If the MediaChecker cannot report the distance, you can use the information in this section to calculate the distance to the short.

You can also use this information to calculate the approximate length of a terminated cable.

The MediaChecker reports information on shorts and terminated cables as follows:

Short across a data pair: The MediaChecker measures the resistance of the short, then displays the distance to the short based on the resistance.

Short across a power pair or from a power wire to a data wire: The MediaChecker measures and displays the resistance of the short. You can use the resistance value to calculate the distance to the short.

Short across the shield and any other wire: The MediaChecker reports the short, but cannot measure its resistance or determine the distance to the short. You can use an ohmmeter to measure the resistance; then use the resistance to calculate the distance to the short.

Terminated cable: The MediaChecker indicates a fault and displays a resistance. To determine the approximate length of a terminated cable, subtract the terminator's resistance (75 Ω for ControlNet; 120 Ω for DeviceNet) from the measured resistance; then use the remaining resistance as R_s in the following procedure. Note that the terminator's tolerance will add some degree of error to the calculation.

Important: When testing Ethernet cable, the MediaChecker can report the distance to all the shorts described above because additional test data is available from other wire pairs.

Use the following formula to calculate the distance to a short. Refer to Tables 13 and 14 for cable resistances.

$$\text{Distance to short} = \frac{R_s}{R_1 + R_2}$$

R_s : Resistance of the short, as measured by the MediaChecker or with your own meter.

R_1 : Resistance per unit of length of one of the shorted conductors.

R_2 : Resistance per unit of length of the other shorted conductor.

Following is a sample calculation:

A DeviceNet Thin cable is shorted across H and the shield. Here are the resistance values:

- R_s (as measured with an ohmmeter): 10 Ω
- R_1 (resistance of H): 0.028 Ω/ft
- R_2 (shield resistance): 0.0032 Ω/ft

$$\text{Distance to short} = \frac{10 \Omega}{0.028 \Omega/\text{ft} + 0.0032 \Omega/\text{ft}}$$

$$= \frac{10 \Omega}{0.0312 \Omega/\text{ft}} = 321 \text{ ft}$$

Table 13. DeviceNet and DH+/RIO Cable Resistances

| Cable Type | Data Pair (H, L) | Power Pair (+,-) | Shield |
|-----------------------|---|---|---|
| DeviceNet Thick | 0.0069 Ω /ft 0.0226 Ω /m | 0.0032 Ω /ft 0.0105 Ω /m | 0.00175 Ω /ft 0.00575 Ω /m |
| DeviceNet Thin | 0.028 Ω /ft 0.0918 Ω /m | 0.01617 Ω /ft 0.053 Ω /m | 0.0032 Ω /ft 0.0105 Ω /m |
| DeviceNet KwikLink | 0.00404 Ω /ft 0.01325 Ω /m | 0.00404 Ω /ft 0.01325 Ω /m | NA |
| DH+/RIO | 0.00944 Ω /ft 0.031 Ω /m | NA | 0.0041 Ω /ft 0.0135 Ω /m |

Table 14. ControlNet Cable Resistances

| Cable Type | Center Conductor | Shield |
|------------------|---|---|
| ControlNet RG6 | 0.028 Ω /ft 0.0918 Ω /m | 0.0036 Ω /ft 0.0118 Ω /m |
| ControlNet RG6F | 0.0099 Ω /ft 0.0325 Ω /m | 0.0029 Ω /ft 0.0095 Ω /m |
| ControlNet DS3/4 | 0.0255 Ω /ft 0.0836 Ω /m | 0.0032 Ω /ft 0.0105 Ω /m |

Setup Selections

In setup mode you can select cable characteristics and customize the MediaChecker's operation. Once changed, these settings are stored and remain in the MediaChecker even when it is turned off.

In setup mode you can do the following:

- Select a network protocol (Ethernet, ControlNet, DeviceNet, DH+/RIO)
- Select a cable type
- Select a cable category
- Select a wire size
- Calibrate the MediaChecker to a specific cable
- Enable or display the beeper for "PASS" and "FAIL" results
- Adjust the display contrast

To make a SETUP selection, do the following:

1. Press **SETUP**.
2. Press **ENTER** to step through the selections.
3. Press **▲** or **▼** to select the desired setup condition.
4. Press **SETUP** to exit the setup mode, or press **ENTER** to move to the next setup selection.

Setup selections that rarely need changing are under a special "Power-up" menu. From the Power-up menu, you can do the following:

- Select the display language
- Select length measurement units between feet (') and meters (m)
- Select wire size units between AWG and millimeters (mm)
- Set the noise filter for 50 Hz or 60 Hz

To make a Power-up setup selection, do the following:

1. With the MediaChecker OFF, press and hold **SETUP** while turning the rotary switch to TEST.
2. Press **ENTER** to step through the selections.
3. Press **▲** or **▼** to select the desired setup condition.
4. Press **SETUP** to exit the setup mode, or press **ENTER** to move to the next setup selection.

Maintenance

General

Periodically wipe the case with a damp cloth and detergent; do not use abrasives or solvents. Clean and dry as required. If the MediaChecker will remain unused for an extended period, remove the batteries to prevent damage from leakage.

Replacing Batteries

Two 1.5 V AA alkaline batteries power the MediaChecker and typically provide 50 hours of operation. Using the backlight may significantly reduce battery life. Figure 5 shows how to replace the batteries.

Determining the Software Version

The version number of your MediaChecker's software appears briefly on the display when you turn on the MediaChecker. To hold the version number on the display, hold down **SETUP** while turning on the MediaChecker.

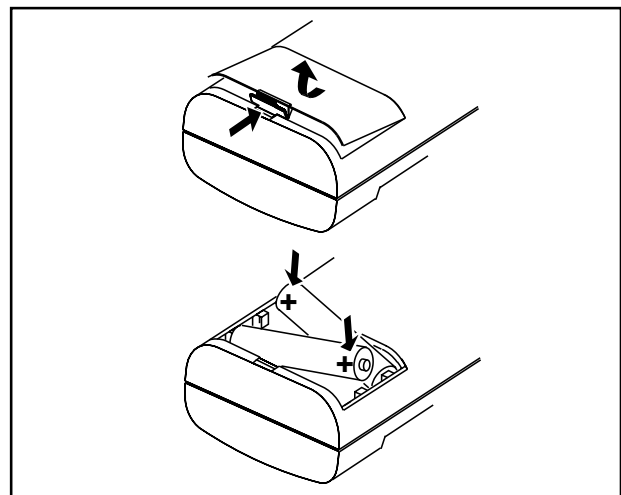

aan05f.eps

Figure 5. Replacing the Batteries

When Something Goes Wrong

If the MediaChecker seems to be malfunctioning, try the troubleshooting steps in Table 15 before returning the MediaChecker to Rockwell Automation for repair.

Table 15. Troubleshooting the MediaChecker

| Symptom 1: Display goes blank. | | |
|---|---------------------------|--|
| Action | Result | Explanation |
| 1. Turn the rotary switch to OFF, wait 5 seconds and turn the switch to TEST. | Display is active | The Battery Save feature turned the MediaChecker off.* |
| | Display still blank | Go to step 2. |
| 2. Replace the batteries (see "Replacing Batteries" on page 36). | Display is active | Batteries were too low to run the MediaChecker. |
| | Display still blank | Go to step 3. |
| 3. Return the MediaChecker for repair. See "Returning the MediaChecker for Repair" on page 39. | | Problem appears to be a MediaChecker malfunction. |
| Symptom 2: The MediaChecker seems to be measuring incorrectly. | | |
| 1. Perform a self-test on the MediaChecker. See "Performing a Self-Test" on page 38. | Self-test fails | Internal circuitry is defective. Go to step 3. |
| | Self-test passes | Go to step 2. |
| 2. Calibrate the MediaChecker as described on page 10. | Calibration not effective | Go to step 3. |
| 3. Return the MediaChecker for repair. See "Returning the MediaChecker for repair" on page 39. | | Problem appears to be a MediaChecker malfunction. |
| * To disable Battery Save, turn the rotary switch to OFF, then press and hold ENTER while turning the rotary switch to TEST. | | |

Performing a Self-Test

When the MediaChecker is on, it periodically tests some of its internal circuits. If a problem is detected, the MediaChecker displays the following message:

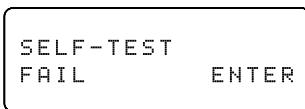

```
SELF-TEST
FAIL      ENTER
```

aan16f.eps

You can perform a more thorough self-test on DeviceNet, DH+/RIO, and Ethernet functions as follows:

1. With the MediaChecker off, press and hold **SETUP** while turning the rotary switch to TEST.
2. Press **ENTER** until "SELF-TEST?" is displayed.
3. Press **▲** or **▼** to select "YES".

Important: To exit without performing a self-test, either press **SETUP**, or ensure that the second line is displaying "NO" and press **ENTER** to move to the next setup selection.

4. Press **ENTER** to activate the self-test program.

You will be prompted to install the Cable ID. There are two ways to install the Cable ID, each with different results:

- To run a self-test on DeviceNet and DH+/RIO functions, connect a DB9-to-Mini/Micro male adapter in series with a Mini/Micro female-to-DB 9 adapter. Use this series combination to connect between the DB9 connector on the Cable ID and the DB9 connector on the MediaChecker.

- To run a self-test on Ethernet functions, connect an Ethernet patch cord to the RJ45-to-DB9 adapter. Use this series combination to connect from the DB9 connector on the Cable ID to the RJ45 connector on the MediaChecker.
5. After installing the Cable ID, press **ENTER** to continue the self-test program.

The MediaChecker displays "PASS" or "FAIL". The self-test repeats until you press **SETUP** or the MediaChecker turns itself off (Battery Save function).

If any failure is detected, return the unit to Rockwell Automation for repair.

To check the MediaChecker's coaxial cable functions, run the TEST and LENGTH tests on a known length of cable.

Returning the MediaChecker for Repair

If after performing the previous tests you believe the MediaChecker is not performing properly, send the complete kit to a local Rockwell Automation location for repair. Rockwell Automation assumes no responsibility for damage in transit.

A 1788-MCHKR MediaChecker covered by the limited warranty will be promptly repaired or replaced (at Rockwell Automation's option) and returned to you at no charge. If the warranty has lapsed, the MediaChecker will be repaired and returned for a fixed fee. Contact a Rockwell Automation distributor for information and prices.

Parts and Accessories**Table 16. Parts and Accessories**

| Description | Part No. |
|--|---------------|
| RA (Resistive Adapter) cable identifier with female DB9 connector | 97157801 |
| Users manual (multi-language) | 957259-13 |
| Quick reference card | 957259-93 |
| 1788-MCHKR Accessory Kit <ul style="list-style-type: none">• 1 RJ-45F to DB9 male adapter• 1 RJ-45 to RJ-45 straight-through patch cable• 2 Male DB9 to male 3-pin Phoenix adapters• 2 Male DB9 to male 5-pin Phoenix adapters• 2 Male DB9 to male mini adapters• 2 Male DB9 to male micro adapters• 2 Male DB9 to 5 alligator clips lead• 1 Male DB9 to female micro adapter• 1 Male DB9 to female mini adapter | 1788-MCHKRACC |

Specifications

These specifications assume the MediaChecker was calibrated using 100 ft (30 m) (or more) of cable of the same type and batch as the cable being measured. Accuracy is specified for two years after calibration.

Coax Termination Measurements

Any loop resistance value between 5 Ω and 350 Ω is interpreted as a terminator resistance. Resistance values below 5 Ω are considered shorts; resistance values greater than 350 Ω are displayed as >350 Ω .

Input Connectors

RJ45, DB-9, and BNC

Input Protection

Will withstand connection to any of the supported networks in a live condition with a supply voltage not exceeding 25 V.

“ACTIVE CABLE” is displayed and an audible signal sounds when the MediaChecker is connected to a cable with voltage present.



ATTENTION: Never connect the MediaChecker to any telephony inputs, systems, or equipment, including ISDN.

Table 17. Cable Test Characteristics

| Network | Cable | Wiring | Pass/Fail Pins |
|------------|----------------------|----------------|---|
| DeviceNet | Thick and Thin | DeviceNet | Data pair, power pair, shield |
| DeviceNet | KwikLink | DeviceNet | Data pair, power pair |
| DH+/RIO | Blue Hose or similar | DH+ | Data pair, shield |
| ControlNet | RG6, RG6F, DS3/4 | Coaxial | Center pin and shield |
| Ethernet | UTP/FTP | EIA/TIA 4-pair | Wire pairs 1, 2; 3, 6; 4, 5; 7, 8 Also the foil (shield) for FTP |

Table 18. ControlNet Cable Test Specifications

| Cable ¹ | Range | Cable Length | | Distance to Short | |
|---|-----------------------------------|-------------------|-------------------------|-------------------------------|-------------------------|
| | | Accuracy | Resolution ² | Accuracy | Resolution ² |
| ControlNet RG-6 ControlNet RG-6F (high flex RG-6) ControlNet DS3/4 5065 | 1 m to 650 m (2 ft to 2130 ft) | 10 % + 1 m (6 ft) | 0.5 m (1 ft) | 10 % + 10 m (10 % + 30 ft) | 1 m (5 ft) |
| <p>1. For these cable types, the length to an open is displayed, but the "OPEN" error message is not displayed.</p> <p>2. 0.5 m (1 ft) for cables <100 m long (328 ft); 1 m (5 ft) for cables >100 m long; 1 ft (0.5 m) for cables to 999 ft long (305 m); 10 ft for cables > 999 ft long.</p> | | | | | |

Table 19. DeviceNet Cable Test Specifications

| Cable ¹ | Range ² | Cable Length | | Distance to Short | |
|--|--------------------------------|------------------|------------|-----------------------|-------------------------|
| | | Accuracy | Resolution | Accuracy ² | Resolution ³ |
| DeviceNet Thick | 1 m to 500 m (3 ft to 1640 ft) | 7 % + 2 m (6 ft) | See Note 3 | 10 % + 12 m (40 ft) | 1 m (5 ft) |
| DeviceNet KwikLink | 1 m to 420 m (3 ft to 1380 ft) | | | | |
| DeviceNet Thin | 1 m to 100 m (3 ft to 328 ft) | | | 7 % + 3 m (10 ft) | 0.5 m (1 ft) |
| <p>1. For these cable types, the length to an open is displayed, but the "OPEN" error message is not displayed.</p> <p>2. For the data pair only. Lengths greater than 999 ft are rounded to the nearest 10 ft.</p> <p>3. 0.5 m (1 ft) for cables <100 m long (328 ft); 1 m (5 ft) for cables >100 m long; 1 ft (0.5 m) for cables to 999 ft long (305 m); 10 ft (3 m) for cables >999 ft long.</p> | | | | | |

Table 20. DH+/RIO Cable Test Specifications

| Cable ¹ | Range | Cable Length | | Distance to Short | |
|--|----------------------------------|------------------|-------------------------|----------------------------|-------------------------|
| | | Accuracy | Resolution ² | Accuracy ³ | Resolution ² |
| DH+/RIO 1770-CD DH+/RIO 9022 DH+/RIO 9463 | 1 m to 350 m (2 ft to 999 ft) | 7 % + 2 m (6 ft) | See Note 2 | 7 % + 3 m (7 % + 10 ft) | 0.5 m (1 ft) |
| <ol style="list-style-type: none"> For these cable types, the length to an open is displayed, but the "OPEN" error message is not displayed. 0.5 m (1 ft) for cables <100 m long (328 ft); 1 m (5 ft) for cables >100 m long; 1 ft (0.5 m) for cables to 999 ft long (305 m); 10 ft (3 m) for cables >999 ft long. For the data pair only. | | | | | |

Table 21. Ethernet Cable Test Specifications

| Test | Range | Accuracy | Resolution ² |
|---|-------------------------------|-------------------------|-------------------------|
| Cable length | 1 m to 350 m (2 ft to 999 ft) | 7 % + 0.5 m (1 ft) | 0.5 m (1 ft) |
| Distance to short | | 7 % + 3 m (7 % + 10 ft) | |
| Distance to open | | 7 % + 3 m (7 % + 10 ft) | |
| Split pairs ¹ | | NA | NA |
| <ol style="list-style-type: none"> Testing for split pairs requires 2 or more pairs with similar capacitance. Split pair section of the cable must be at least 2 meters (6 ft) long and greater than 10 % of the total cable length. 0.5 m (1 ft) for cables <100 m long (328 ft); 1 m (5 ft) for cables >100 m long; 1 ft (0.5 m) for cables to 999 ft long (305 m); 10 ft (3 m) for cables >999 ft long. | | | |

Power

Two AA size 1.5 V alkaline batteries
Battery type: ANSI/NEDA-15A or IEC-LR6
Low battery indicated on the display
Typical battery life: 50 hours
Timed power-off function (Battery Save feature)

Dimensions

18.4 cm x 9.8 cm x 4.6 cm
(7.25 in x 3.875 in x 1.8 in)

Weight

354.4 g (12.5 oz)

Environmental Conditions

Temperature

Non-operating (storage): -20 °C to +60 °C
Operating: 0 °C to +45 °C

Operating Humidity

10 °C to 30 °C: 95 % ±5 % RH (without condensation)
30 °C to 40 °C: 75 % ±5 % RH (without condensation)
40 °C to 45 °C: 45 % ±5 % RH (without condensation)

Altitude

Non-operating: 0 km to 12 km (40,000 ft)
Operating: 0 km to 4.57 km (15,000 ft)

Electromagnetic Compatibility

Meets FCC part 15-b
Meets EN 50081-1: 1993, EN 50082-1; 1995

 Meets AS/NZS 2064
N223

Safety

 EN60950 2nd edition, 1,2,3,4 Low Voltage
Directive

 C22.2 No. 950 2nd edition (1996)

Display

LCD (2 lines of 16 characters) with backlight

Controls

Four-position rotary switch and 5 tactile-feedback
momentary switches

Warranty

One year from date of purchase

Calibration Period

Two years from manufacturing date