



DeviceNet Analog Base D-Shell CompactBlock LDX I/O

(Cat. Nos. 1790D-N4C0, -N0C2, -N4V0, -N0V2)

What This Document Describes

This document describes how to install your CompactBlock LDX™ I/O blocks.

For information on:	Refer to page:
EDS File Requirements	below
Important User Information	2
Installing CompactBlock I/O	5
Wiring the D-Shell Connectors	8
Connecting the DeviceNet Cable	9
I/O Memory Mapping	11
Troubleshooting with the Indicators	12
Module Specifications	15

EDS File Requirements

Current functionality of CompactBlock LDX I/O blocks requires current modular EDS file for RSNetWorx for DeviceNet™ version 3.0 or later software.

These files are easy to install and are available online at:
www.ab.com/networks/eds/

EDS files for blocks with matching catalog numbers (for both D-Shell and terminal block versions) are the same. Thus, on the website and in RSNetWorx for DeviceNet, there is only one EDS file for both versions of the blocks. For example, if you want the EDS file for 1790D-T8BV8B, use the EDS file labeled 1790D-8BV8B.

Important User Information

Because of the variety of uses for the products described in this publication, those responsible for the application and use of these products must satisfy themselves that all necessary steps have been taken to assure that each application and use meets all performance and safety requirements, including any applicable laws, regulations, codes and standards. In no event will Rockwell Automation be responsible or liable for indirect or consequential damage resulting from the use or application of these products.

Any illustrations, charts, sample programs, and layout examples shown in this publication are intended solely for purposes of example. Since there are many variables and requirements associated with any particular installation, Rockwell Automation does not assume responsibility or liability (to include intellectual property liability) for actual use based upon the examples shown in this publication.

Allen-Bradley publication SGI-1.1, *Safety Guidelines for the Application, Installation and Maintenance of Solid-State Control* (available from your local Rockwell Automation office), describes some important differences between solid-state equipment and electromechanical devices that should be taken into consideration when applying products such as those described in this publication.

Reproduction of the contents of this copyrighted publication, in whole or part, without written permission of Rockwell Automation, is prohibited.

Throughout this publication, notes may be used to make you aware of safety considerations. The following annotations and their accompanying statements help you to identify a potential hazard, avoid a potential hazard, and recognize the consequences of a potential hazard:

WARNING

Identifies information about practices or circumstances that can cause an explosion in a hazardous environment, which may lead to personal injury or death, property damage, or economic loss.

ATTENTION

Identifies information about practices or circumstances that can lead to personal injury or death, property damage, or economic loss.

IMPORTANT

Identifies information that is critical for successful application and understanding of the product.

ATTENTION**Preventing Electrostatic Discharge**

This equipment is sensitive to electrostatic discharge, which can cause internal damage and affect normal operation. Follow these guidelines when you handle this equipment:

- Touch a grounded object to discharge potential static.
 - Wear an approved grounding wriststrap.
 - Do not touch connectors or pins on component boards.
 - Do not touch circuit components inside the equipment.
 - If available, use a static-safe workstation.
 - When not in use, store the equipment in appropriate static-safe packaging.
-

ATTENTION**Environment and Enclosure**

This equipment is intended for use in a Pollution Degree 2 industrial environment, in overvoltage Category II applications (as defined in IEC publication 60664-1), at altitudes up to 2000 meters without derating.

This equipment is considered Group 1, Class A industrial equipment according to IEC/CISPR Publication 11. Without appropriate precautions, there may be potential difficulties ensuring electromagnetic compatibility in other environments due to conducted as well as radiated disturbance.

This equipment is supplied as "open type" equipment. It must be mounted within an enclosure that is suitably designed for those specific environmental conditions that will be present and appropriately designed to prevent personal injury resulting from accessibility to live parts. The interior of the enclosure must be accessible only by the use of a tool. Subsequent sections of this publication may contain additional information regarding specific enclosure type ratings that are required to comply with certain product safety certifications.

See NEMA Standards publication 250 and IEC publication 60529, as applicable, for explanations of the degrees of protection provided by different types of enclosure. Also, see the appropriate sections in this publication, as well as the Allen-Bradley publication 1770-4.1 ("Industrial Automation Wiring and Grounding Guidelines"), for additional installation requirements pertaining to this equipment.

Installing CompactBlock LDX I/O

Follow these steps to install the block:

1. Set the node address on the base block.
2. Mount the base block.
3. Mount the optional expansion blocks.
4. Wire the D-Shell connectors.
5. Connect the DeviceNet cable.

These steps are explained in detail in the following procedures.

Set the Node Address on the Base Block

Each base block comes with its internal program set for node address 63. To reset the node address, adjust the switches on the front of the block. The two switches are most significant digit (MSD) and least significant digit (LSD). The switches can be set between 00 and 63.

The base block reads the rotary switches at power up only. Switch settings between 64 and 99 cause the block to use the last valid node address stored internally.

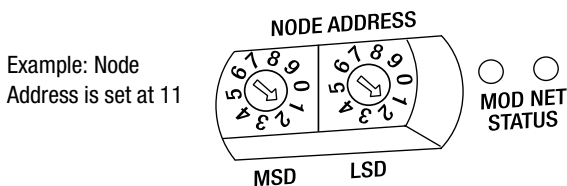

The node address may also be set through RSNetWorx for DeviceNet or a similar configuration tool. When software configuration is used for the node address, the switches must be set between 64 and 99.

Mount the Base Block

You can mount the base block to a panel or DIN rail. We recommend that you ground the panel or DIN rail before mounting the block.

IMPORTANT

The analog base module can accommodate a **maximum** of two discrete expansion modules.

WARNING



When used in a Class I, Division 2, hazardous location, this equipment must be mounted in a suitable enclosure with the proper wiring method that complies with the governing electrical codes.

Panel Mounting

1. Place the block against the panel where you want to mount it.
2. Gently pull and position the expansion cover to the left.
3. Place a center punch, nail or similar device through the mounting holes in the block and make two marks on the panel (lower left and upper right corners of the module).
4. Remove the block and drill two holes in the panel to accommodate each of the mounting screws.

- Replace the block on the panel and place a screw through each of the two mounting holes. Tighten the screws until the block is firmly in place.

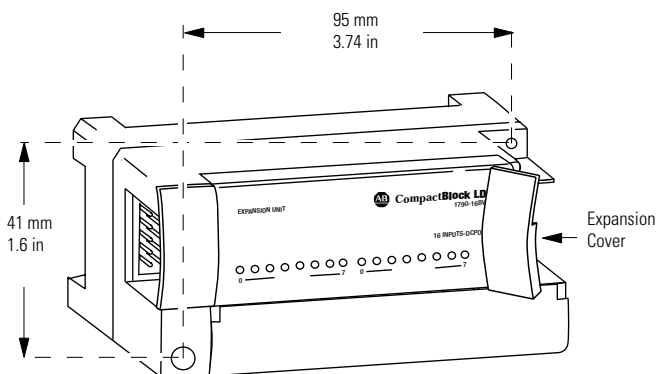

DIN Rail Mounting

- Hook the top slot of the block over the DIN Rail.
- Pull down on the locking lever while pressing the block against the rail.

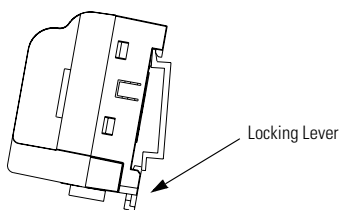

- Push up on the locking lever to secure the block to the rail when block is flush against the rail.

Mount the Optional Expansion Blocks

Mount the expansion block by connecting it to a previously-installed CompactBlock LDX I/O base or expansion block.

Beginning with the base block, you can mount your expansion blocks either horizontally or vertically:

- horizontally (left to right) - add expansion blocks in an end-to-end configuration
- vertically (up or down) - add expansion blocks either up or down in a back-to-back configuration. In this configuration, you must use the optional 15cm ribbon cable (1790-15CMCBL) and alternately position the blocks in a right-side up, upside-down fashion.

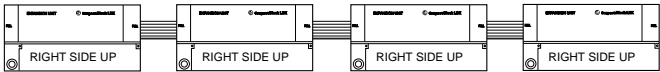

Horizontal mounting

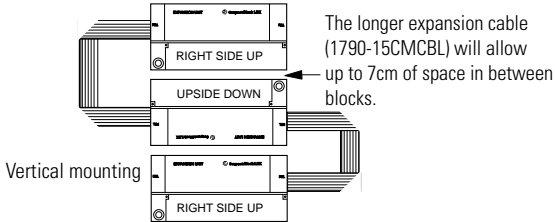

Vertical mounting

You can mount your blocks on a panel or DIN rail as described in the previous section.

Wire the D-Shell Connectors

The following figures show how to wire the D-Shell connectors.

1790D-N4C0 Current Analog Input Module Wiring Diagram for D-Shell Connector

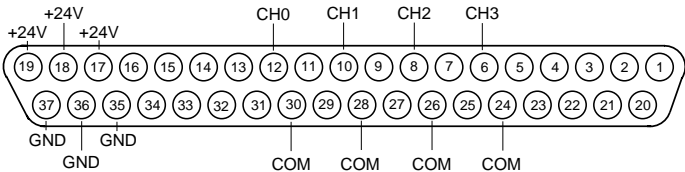

- Wire pins 17, 18 and 19 to Field Power (+) 24Vdc
Wire pins 35, 36 and 37 to Field Power (-) GND

1790D-N0C2 Current Analog Input Module Wiring Diagram for D-Shell Connector

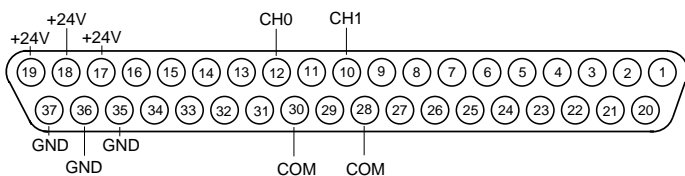

- Wire pins 17, 18 and 19 to Field Power (+) 24Vdc
Wire pins 35, 36 and 37 to Field Power (-) GND

1790D-N4V0 Voltage Analog Input Module Wiring Diagram for D-Shell Connector

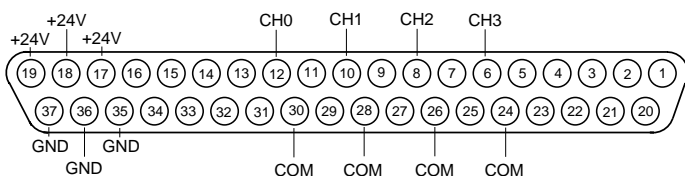

- Wire pins 17, 18 and 19 to Field Power (+) 24Vdc
Wire pins 35, 36 and 37 to Field Power (-) GND

1790D-N0V2 Voltage Analog Output Module Wiring Diagram for D-Shell Connector

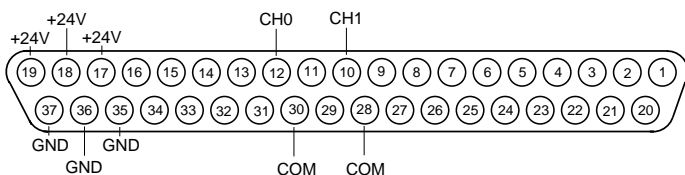

- Wire pins 17, 18 and 19 to Field Power (+) 24Vdc
Wire pins 35, 36 and 37 to Field Power (-) GND

Connect the DeviceNet Cable

The following procedures describe how to connect the DeviceNet cable to the base block.

The required DeviceNet connector **is not supplied** with the block - you must purchase it separately. There are three types of connectors that you can order directly from Rockwell Automation or your local distributor:

- 1799-DNETCON - 5-position open style connector
- 1799-DNETSCON - 5-position open style connector with locking screws
- 1799-DNC5MMS - 5-position open style to 12mm connector with locking screws

WARNING



If you connect or disconnect the DeviceNet cable with power applied to this module or any device on the network, an electrical arc can occur. This could cause an explosion in hazardous location installations.

Be sure that power is removed or the area is nonhazardous before proceeding.

Connect the DeviceNet wiring (drop line) to one of the DeviceNet connectors as shown below. A color-coded wiring diagram is also printed next to the connector on the left side of the module

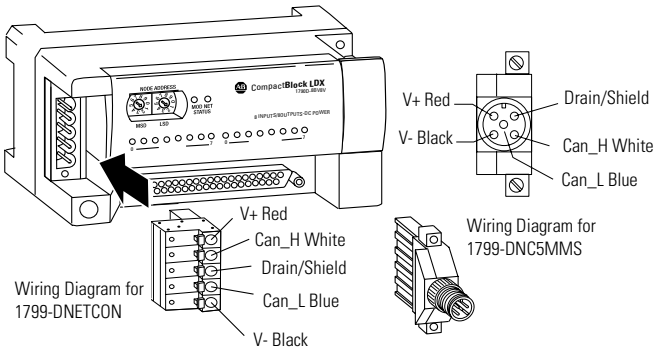

Once you have properly wired the drop line to the connector, attach the connector to the block. If applicable, use the locking screws on the connector to fasten it to the block.

I/O Memory Mapping

1790D-N4C0, -N4V0 Input Data File

Word	Bit Position															
	15	14	13	12	11	10	9	8	7	6	5	4	3	2	1	0
0	Not Used				Analog Input Data Channel 0											
1	Not Used				Analog Input Data Channel 1											
2	Not Used				Analog Input Data Channel 2											
3	Not Used				Analog Input Data Channel 3											
4	Not Used											S	S	S	S	
													3	2	1	0

Word/Bit Descriptions for 1790D-N4C0, -N4V0 Analog Input Module

Word	Decimal Bit	Description
Read Word 0	Bits 00-11	Channel 0 input data
	Bits 12-15	Not used: Set to 0
Read Word 1	Bits 00-11	Channel 1 input data
	Bits 12-15	Not used: Set to 0
Read Word 2	Bits 00-11	Channel 2 input data
	Bits 12-15	Not used: Set to 0
Read Word 3	Bits 00-11	Channel 3 input data
	Bits 12-15	Not used: Set to 0
Read Word 4	Bits 00-03	Status bits for individual channels - Bit 00 corresponds to input channel 0, bit 01 corresponds to input channel 1 and so on. When set (1) indicates: <ul style="list-style-type: none"> • No field power • Open wire (4-20mA current input only) • Under range (4-20mA current input only) • Recoverable module fault (whole channel to be set) • Unrecoverable module fault (whole channel to be set)
	Bits 04-15	Not used: Set to 0

1790D-NOC2, -NOV2 Output Data File

Word	Bit Position															
	15	14	13	12	11	10	9	8	7	6	5	4	3	2	1	0
0	Not Used				Analog Output Data Channel 0											
1	Not Used				Analog Output Data Channel 1											

Word/Bit Descriptions for 1790D-NOC2, -NOV2 Analog Output Module

Word	Decimal Bit	Description
Write Word 0	Bits 00-11	Channel 0 output data
	Bits 12-15	Not used: Set to 0
Write Word 1	Bits 00-11	Channel 1 output data
	Bits 12-15	Not used: Set to 0

Troubleshoot with the Indicators

The 1790D I/O block has the following indicators:

- module status
- network status
- I/O status

Mod/Net Status Indicator		
LED Indicator:	Status:	Description:
Module Status	Solid Red	Unrecoverable fault in base unit
	Flashing Red	Recoverable fault
	Solid Green	Normal operation - OK
	Flashing Green	Standby
	Off	No power
LED Indicator:	Status:	Description:
Network Status	Solid Red	Unrecoverable communication fault
	Flashing Red	Recoverable communication fault
	Solid Green	Communication path complete - OK
	Flashing Green	Communication path incomplete
	Off	Device not online or not powered

I/O Channel LED Status Indicator			
1790D-N4V0		1790D-N4C0	
Status:	Description:	Status:	Description:
Flashing Green/ Red	Power up	Flashing Green/ Red	Power up
Off	Off line	Off	Off line
Red	On line and no field power	Red	On line and no field power
Red	DeviceNet connection and no field power	Red	DeviceNet connection and no field power
Green	Field power and open wire	Flashing Red ¹	Field power and open wire (4-20mA range only) ²
Green	Field power and valid input	Green	Field power and valid input
Green	Input over range	Green	Input over range
Green	Input under range	Flashing Red ¹	Input under range <3mA (4-20ma range only) ²
Flashing Red	Recoverable fault	Flashing Red	Recoverable fault

¹ Green for 0-20mA range.

² Can be determined from the data table.

I/O Channel LED Status Indicator			
1790D-NOV2		1790D-NOC2	
Status:	Description:	Status:	Description:
Flashing Green/ Red	Power up	Flashing Green/ Red	Power up
Off	Off line	Off	Off line
Off	On line and no field power	Off	On line and no field power
Green	DeviceNet connection and no field power	Green	DeviceNet connection and no field power
Green	Field power and open wire	Green	Field power and open wire
Green	Field power and valid output	Green	Field power and valid output
Flashing Red	Field power and output out of range	Flashing Red	Field power and output out of range
Flashing Green	Output idle	Flashing Green	Output idle
Flashing Red	Recoverable fault	Flashing Red	Recoverable fault

DeviceNet Analog Base D-Shell Block Specifications

The following table contains specifications that are common to all of the blocks in this document. Individual base block specifications are detailed after this table.

Environmental Specifications	
Operating Temperature	0 to 55°C (32 to 131°F) - Analog I/O IEC 60068-2-1 (Test Ad, Operating Cold), IEC 60068-2-2 (Test Bd, Operating Dry Heat), IEC 60068-2-14 (Test Nb, Operating Thermal Shock)
Storage Temperature	-40 to 85°C (-40 to 185°F) IEC 60068-2-1 (Test Ab, Un-packaged Non-operating Cold), IEC 60068-2-2 (Test Bb, Un-packaged Non-operating Dry Heat), IEC 60068-2-14 (Test Na, Un-packaged Non-operating Thermal Shock)
Relative Humidity	5-90% non-condensing IEC 60068-2-30 (Test Db, Un-packaged Non-operating)
Operating Altitude	2000m
Vibration	2g @ 10-500Hz IEC60068-2-6 (Test Fc, Operating)
Shock	
Operating	10g
Non-operating	30g EC60068-2-27 (Test Ea, Unpackaged Shock)
Emissions	Group 1, Class A CISPR 11
ESD Immunity	8kV air discharges IEC 61000-4-2
Radiated RF Immunity	10V/m with 1kHz sine-wave 80%AM from 80MHz to 1000MHz 10V/m with 200Hz 50% Pulse 100%AM @ 900Mhz IEC 61000-4-3
EFT/B Immunity	1kV @ 5kHz on power ports ±2kV @ 5kHz on signal ports ±2kV @ 5kHz on communications ports IEC 61000-4-4
Surge Transient Immunity	±1kV line-line(DM) and ±2kV line-eath(CM) on signal ports ±2kV line-earth(CM) on shielded ports IEC 61000-4-5
Conducted RF Immunity	10Vrms with 1kHz sine-wave 80%AM from 150kHz to 80MHz IEC 61000-4-6
Enclosure Type Rating	None (open style)
Mounting	DIN rail or screw
Dimensions	52x104x42mm (2.03x4.07x1.64in)
Weight	0.3lb (0.1kg)

Specifications continued on next page.

DeviceNet Specifications	
Network protocol	I/O Slave messaging: - Poll command - Bit Strobe command - Cyclic command - COS command
Network length	500 meters maximum @ 125Kbps 100 meters maximum @ 500Kbps
Indicators	1 red/green module status 1 red/green network status
Number of nodes	64 maximum - rotary switch type node address setting
Communication rate	125Kbps, 250Kbps, 500Kbps - auto baud rate selection
Isolation	Type test 1250Vac rms for 60 seconds between field power and DeviceNet (I/O to logic)
Wiring	Refer to publication DN-6.7.2
General Specifications	
Wiring Category	2 ¹
Product Certifications (when product is marked)	c-UL-us UL Listed for Class I, Division 2 Group A,B,C,D Hazardous Locations, certified for U.S. and Canada CE ² European Union 89/336/EEC EMC Directive, compliant with: EN 61000-6-4; Industrial Emissions EN 50082-2; Industrial Immunity EN61326; Meas./Control/Lab., Industrial Requirements EN 61000-6-2; Industrial Immunity C-Tick ² Australian Radiocommunications Act, compliant with: AS/NZS CISPR11; Industrial Emissions ODVA ODVA conformance tested to DeviceNet specifications

¹ Refer to publication 1770-4.1, *Programmable Controller Wiring and Grounding Guidelines*.

² See the Product Certification link at www.ab.com for Declarations of Conformity, Certificates, and other certification details.

4-Channel Analog Current Input Module Specifications

1790D-N4C0	
Inputs per module	4 channel single-ended, non-isolated
Input Current (software configurable)	4-20mA (default) 0-20mA
Resolution	12 bits-unipolar 1/4096 maximum 3.90 μ A/bit (4-20mA) 4.88 μ A/bit (0-20mA)
Converted Data	Binary data 0000 to 0fff (max scale)
Conversion Time	10ms/channel
Overall accuracy	0.2% Full scale @0°-55°C
Calibration	None required
Input Impedance	249 Ω
Insulation Resistance	20M Ω minimum @ 250V dc (between insulated circuits)
General Specifications	
DeviceNet Power	Supply voltage - 24V dc nominal Voltage range - 11-28.8V dc Power dissipation - 1.2W maximum @ 28.8V dc
Field Power	Supply Voltage - 24Vdc nominal Voltage Range - 21.6-26.4V dc (\pm 10%) Power Dissipation - 1.5W maximum @26.4V dc
Isolation	I/O to logic: photocoupler isolation Isolation voltage: Type Test 1250V ac rms for 60 seconds DeviceNet to logic: non-isolated Field power: non-isolated
Indicators	4 red/green I/O status
Wiring	37-pin D-Shell connector
IMPORTANT: This analog base module can accommodate a maximum of two discrete expansion modules.	

2 Channel Analog Current Output Module Specifications

1790D-NOC2	
Outputs per module	2 channel single-ended, non-isolated
Output Current	0-20mA
Resolution	12 bits 1/4096 maximum 4.88 μ A/bit
Converted Data	Binary data 0000 to 0fff (max scale)
Conversion Time	2ms/channel
Overall accuracy	0.2% Full scale @0°-55°C
Calibration	None required
Allowable external output load resistance	600 Ω maximum
Insulation Resistance	20M Ω minimum @ 250V dc (between insulated circuits)
General Specifications	
DeviceNet Power	Supply voltage - 24V dc nominal Voltage range - 11-28.8V dc Power dissipation - 1.2W maximum @ 28.8V dc
Field Power	Supply Voltage - 24Vdc nominal Voltage Range - 21.6-26.4V dc (\pm 10%) Power Dissipation - 1.5W maximum @26.4V dc
Isolation	I/O to logic: photocoupler isolation Isolation voltage: Type Test 1250V ac rms for 60 seconds DeviceNet to logic: non-isolated Field power: non-isolated
Indicators	2 red/green I/O status
Wiring	37-pin D-Shell connector
IMPORTANT: This analog base module can accommodate a maximum of two discrete expansion modules.	

4 Channel Analog Voltage Input Module Specifications

1790D-N4V0	
Inputs per module	4 channel single-ended, non-isolated
Input Voltage	0-10V
Resolution	12 bits-unipolar 1/4096 maximum 2.44mV/bit
Converted Data	Binary data 0000 to 0fff (max scale)
Conversion Time	10ms/channel
Overall accuracy	0.2% Full scale @0°-55°C
Calibration	None required
Input Impedance	500K Ω minimum
Insulation Resistance	20M Ω minimum @ 250V dc (between insulated circuits)

General Specifications

DeviceNet Power	Supply voltage - 24V dc nominal Voltage range - 11-28.8V dc Power dissipation - 1.2W maximum @ 28.8V dc
Field Power	Supply Voltage - 24Vdc nominal Voltage Range - 21.6-26.4V dc ($\pm 10\%$) Power Dissipation - 1.5W maximum @26.4V dc
Isolation	I/O to logic: photocoupler isolation Isolation voltage: Type Test 1250V ac rms for 60 seconds DeviceNet to logic: non-isolated Field power: non-isolated
Indicators	4 red/green I/O status
Wiring	37-pin D-Shell connector

IMPORTANT: This analog base module can accommodate a **maximum** of two discrete expansion modules.

2 Channel Analog Voltage Output Module Specifications

1790D-NOV2	
Outputs per module	2 channel single-ended, non-isolated
Output Voltage	0-10V
Resolution	12 bits-unipolar 1/4096 maximum 2.44mV/bit
Converted Data	Binary data 0000 to 0fff (max scale)
Conversion Time	2ms/channel
Overall accuracy	0.2% Full scale @0°-55°C
Calibration	None required
Allowable external output load resistance	1K Ω minimum
Output Impedance	0.5 Ω maximum
Insulation Resistance	20M Ω minimum @ 250V dc (between insulated circuits)



General Specifications

DeviceNet Power	Supply voltage - 24V dc nominal Voltage range - 11-28.8V dc Power dissipation - 1.2W maximum @ 28.8V dc
Field Power	Supply Voltage - 24Vdc nominal Voltage Range - 21.6-26.4V dc (\pm 10%) Power Dissipation - 1.5W maximum @26.4V dc
Isolation	I/O to logic: photocoupler isolation Isolation voltage: Type Test 1250V ac rms for 60 seconds DeviceNet to logic: non-isolated DeviceNet power: non-isolated Field power: non-isolated
Indicators	2 red/green I/O status
Wiring	37-pin D-Shell connector

IMPORTANT: This analog base module can accommodate a **maximum** of two discrete expansion modules.

IMPORTANT

Input and output wiring must be in accordance with Class 1, Division 2 wiring methods and in accordance with the authority having jurisdiction.

The following information applies when operating this equipment in hazardous locations:	Informations sur l'utilisation de cet équipement en environnements dangereux :
<p>Products marked "CL I, DIV 2, GP A, B, C, D" are suitable for use in Class I Division 2 Groups A, B, C, D, Hazardous Locations and nonhazardous locations only. Each product is supplied with markings on the rating nameplate indicating the hazardous location temperature code. When combining products within a system, the most adverse temperature code (lowest "T" number) may be used to help determine the overall temperature code of the system. Combinations of equipment in your system are subject to investigation by the local Authority Having Jurisdiction at the time of installation.</p>	<p>Les produits marqués "CL I, DIV 2, GP A, B, C, D" ne conviennent qu'à une utilisation en environnements de Classe I Division 2 Groupes A, B, C, D dangereux et non dangereux. Chaque produit est livré avec des marquages sur sa plaque d'identification qui indiquent le code de température pour les environnements dangereux. Lorsque plusieurs produits sont combinés dans un système, le code de température le plus défavorable (code de température le plus faible) peut être utilisé pour déterminer le code de température global du système. Les combinaisons d'équipements dans le système sont sujettes à inspection par les autorités locales qualifiées au moment de l'installation.</p>
<p style="text-align: center;">WARNING</p> 	<p style="text-align: center;">EXPLOSION HAZARD</p> <ul style="list-style-type: none"> • Do not disconnect equipment unless power has been removed or the area is known to be nonhazardous. • Do not disconnect connections to this equipment unless power has been removed or the area is known to be nonhazardous. Secure any external connections that mate to this equipment by using screws, sliding latches, threaded connectors, or other means provided with this product. • Substitution of components may impair suitability for Class I, Division 2. • If this product contains batteries, they must only be changed in an area known to be nonhazardous.
<p style="text-align: center;">AVERTISSEMENT</p> 	<p style="text-align: center;">RISQUE D'EXPLOSION</p> <ul style="list-style-type: none"> • Couper le courant ou s'assurer que l'environnement est classé non dangereux avant de débrancher l'équipement. • Couper le courant ou s'assurer que l'environnement est classé non dangereux avant de débrancher les connecteurs. Fixer tous les connecteurs externes reliés à cet équipement à l'aide de vis, loquets coulissants, connecteurs filetés ou autres moyens fournis avec ce produit. • La substitution de composants peut rendre cet équipement inadapté à une utilisation en environnement de Classe I, Division 2. • S'assurer que l'environnement est classé non dangereux avant de changer les piles.

This product has been tested at an Open Device Vendors Association, Inc. (ODVA) authorized independent test laboratory and found to comply with ODVA Conformance Test. Please contact the ODVA website (<http://www.odva.org>) for listing of products tested by ODVA independent test labs for further details.

Compact**Block LDX** and RSNetWorx for DeviceNet are trademarks of Rockwell Automation. DeviceNet is a trademark of Open DeviceNet Vendor Association.

www.rockwellautomation.com

Power, Control and Information Solutions Headquarters

Americas: Rockwell Automation, 1201 South Second Street, Milwaukee, WI 53204-2496 USA, Tel: (1) 414.382.2000, Fax: (1) 414.382.4444

Europe/Middle East/Africa: Rockwell Automation, Vorstlaan/Boulevard du Souverain 36, 1170 Brussels, Belgium, Tel: (32) 2 663 0600, Fax: (32) 2 663 0640

Asia Pacific: Rockwell Automation, Level 14, Core F, Cyberport 3, 100 Cyberport Road, Hong Kong, Tel: (852) 2887 4788, Fax: (852) 2508 1846

Publication 1790-IN004B-EN-P - April 2003

PN957782-22

Supersedes Publication 1790-IN004A-EN-P - November 2001

© 2003 Rockwell Automation. Printed in USA