

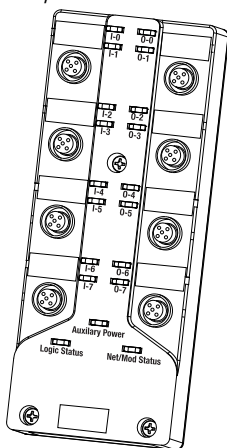

ArmorBlock MaXum 8 Input / 8 Output Module Series B

(Cat. No. 1792D-8BVT8D)



41516

This ArmorBlock MaXum™ I/O module (Cat. No. 1792D-8BVT8D) is a stand-alone 24V dc I/O product which communicates via a DeviceNet™ network. The sealed housing of this module requires no enclosure.

This model has 8 inputs and 8 outputs accessed through Y splitter cables. Inputs are 24V dc automatically configured for PNP (sourcing) or NPN (sinking) devices. Eight self-protected 24V dc outputs can provide up to 0.5 amp each. Diagnostic features are short circuit, open wire, and no load detection reported to the point level. Local logic control has been added to the Series B version of this product.

Allen-Bradley A

Package Contents

Your package contains:

- 1 ArmorBlock MaXum Module
- Installation Instructions

(Note: Cable bases are ordered and shipped separately.)

European Union Directive Compliance

If this product has the CE mark it is approved for installation within the European Union and EEA regions. It has been designed and tested to meet the following directives.

EMC Directive

This product is tested to meet Council Directive 89/336/EEC Electromagnetic Compatibility (EMC) and the following standards, in whole or in part, documented in a technical construction file:

- EN 50081-2 EMC - Generic Emission Standard, Part 2 - Industrial Environment
- EN 50082-2 EMC - Generic Immunity Standard, Part 2 - Industrial Environment

This product is intended for use in an industrial environment.

Low Voltage Directive

This product is tested to meet Council Directive 73/23/EEC Low Voltage, by applying the safety requirements of EN 61131-2 Programmable Controllers, Part 2 - Equipment Requirements and Tests.

For specific information required by EN 61131-2, see the appropriate sections in this publication, as well as the following Allen-Bradley publications:

- Industrial Automation Wiring and Grounding Guidelines For Noise Immunity, publication 1770-4.1
- Automation Systems Catalog, publication B113

Install Your ArmorBlock MaXum I/O Module

To install module:

- Set the node address
- Mount the module to the cable base
- Connect the cord sets
- Communicate with the module

Set the Node Address

Valid node addresses are **00** to **63**.

Set the node address using the rotary switches, RSNetWorx for DeviceNet™, DeviceNetManager™, or other software configuration tool. Setting the switches between **64** to **99** lets the software have address control.

Each module is shipped set for node address **63**. The switches are located on the underside of the module. The two switches are:

- MSD (most significant digit)
- LSD (least significant digit)

To reset the node address, use a small blade screwdriver to rotate the switches. Line up the small black dot on the switch with the number setting you wish to use.

The rotary switches are read at module power up only. Settings between 64 and 99 cause the module to use the last valid node address stored internally. Example: The last setting was 40. If a change is made to 68, and then you power up, the address will default to 40.

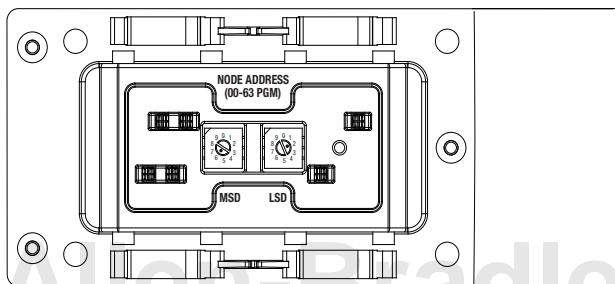

Bottom View of Module
Example: Node Address is set at 62, see small black dots.

41462

The module is equipped with AutoBaud detect. AutoBaud lets the module read the settings already in use on your DeviceNet network and automatically adjusts to follow those settings.

Install the Module

This module mounts to the following cable bases:

- 1792D-CBFM for KwikLink™ flat media installation
- 1792D-CB12 for 12mm drop cable installation
- 1792D-CB18P for round media DeviceNet and output power
- or other optional cable base assembly.

IMPORTANT

The cable base should already be installed. See publication 1792D-IN009B-EN-P to install the cable base.

To install the module:

IMPORTANT

Proper alignment of the screws is necessary to complete the connections between the module contacts and the cable contacts.

1. Position the module over the mounted cable base. Align the three captive screws in the module with the accepting receptacles in the base.
2. Tighten the screws with a torque of 8 inch-pounds to secure the module to the base.

Note: Dimensions change according to the cable base and module combination used.

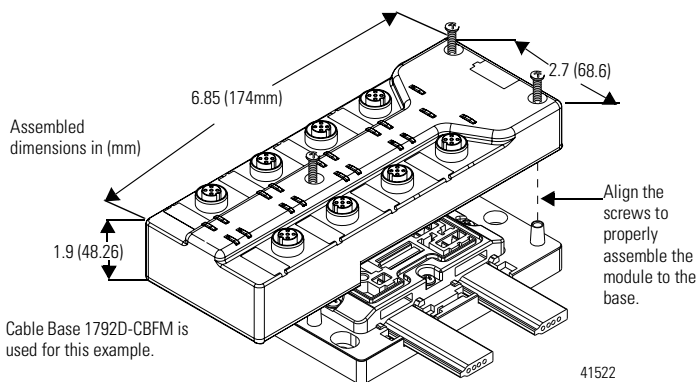

Connect the Input / Output Cord Sets to the MaXum Module

This module uses 5 pin micro (12mm) style PCB mounted connectors. Eight micro caps cover the connectors on your module. Remove the caps and connect your cord sets to the appropriate ports. This product has two inputs or outputs per I/O connector. Use a “Y” splitter cable for access to all I/O connections.

Allen-Bradley A

Use the micro caps to cover and seal unused ports. Pinout diagrams for the connectors are shown next.

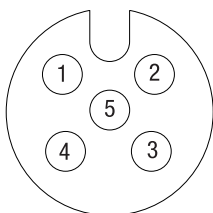

Input Micro-Connector

(View into Socket)

- Pin 1 Sensor Source voltage
- Pin 2 Input B
- Pin 3 Return Logic Ground¹
- Pin 4 Input A
- Pin 5 Not Used

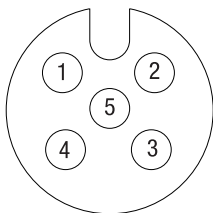

Output Micro-Connector

(View into Socket)

- Pin 1 Not Used
- Pin 2 Output B
- Pin 3 Auxiliary Power Ground
- Pin 4 Output A
- Pin 5 Not Used

¹Logic Ground is approximately 0.4V above DeviceNet V- measured at the module.

41452

Please refer to publication 889-5.0 for Rockwell Automation cables and cord sets offerings.

IMPORTANT

If the devices (sensors) connected to the input connections require Class 2 power to operate, the DeviceNet connections of this equipment must be powered by a Class 2 source.

ATTENTION

- Make sure all connectors and caps are securely tightened to properly seal the connections against leaks and maintain IP67 requirements.
- For maximum noise immunity, input and output cable return wires must be properly terminated. When inputs and outputs are connected in loopback, return wires should be connected together.
- I/O cable length should be less than 30 meters.

I/O connectors for this module are shown below.

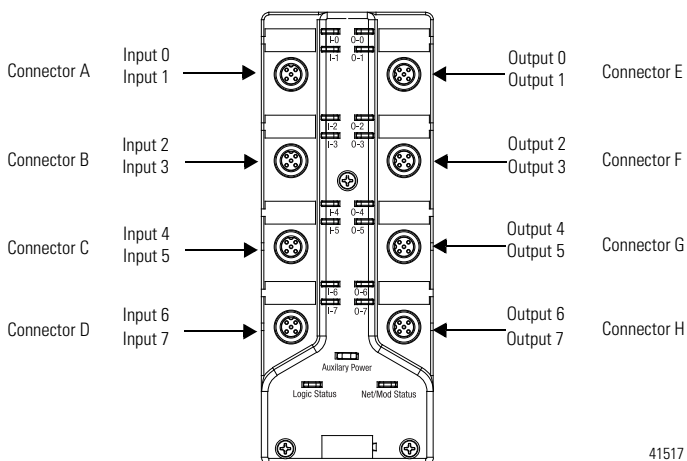

41517

Output Power and DeviceNet Cables

Output power and DeviceNet cables are described in the installation publications for the cable base assembly of your choice. Refer to the following publications:

- 1792D-IN009B-EN-P ArmorBlock MaXum Cable Base Installation Guide
- DN-6.7.2 DeviceNet Cable Planning and Installation Manual

Communicate With Your ArmorBlock MaXum I/O Module

This ArmorBlock module's I/O is exchanged with the master through a poll, change-of-state, or cyclic connection.

The module consumes and produces I/O data as follows:

Type of I/O Connections	Consumes	Produces
Cyclic	1 Byte	4 Bytes
Polled	1 Byte	4 Bytes
Change-of-State	1 Byte	4 Bytes

Cyclic - allows configuration of the block as an I/O client. The block will produce and consume its I/O cyclically at the rate configured.

Polled - a master initiates communication by sending its polled I/O message to the module. The 8 input / 8 output module consumes the message, updates outputs, and produces a response. The response has input data, input faults, output faults, and the status of the Auxiliary power.

Change-of-State - productions occur when an input changes or a fault condition occurs. If no input or fault condition change occurs within the expected packet rate, a heartbeat production occurs. This heartbeat production tells the scanner module that the I/O module is alive and ready to communicate. Consumption occurs when data changes and the master produces new output data to the I/O block.

Refer to the table below for the word/bit definitions.

Bit	07	06	05	04	03	02	01	00
Produces 0	I7	I6	I5	I4	I3	I2	I1	I0
Produces 1	OW-D	OW-C	OW-B	OW-A	ISC-D	ISC-C	ISC-B	ISC-A
Produces 2	OFLT7	OFLT6	OFLT5	OFLT4	OFLT3	OFLT2	OFLT1	OFLT0
Produces 3	RSVD	OPWR	RSVD	RSVD	RSVD	RSVD	RSVD	RSVD
Consumes 0	O7	O6	O5	O4	O3	O2	O1	O0

Where: OW= Off Wire RSVD= Reserved I = Input O = Output OPWR= Output Power (Auxiliary Power) OFLT = Output fault ISC=Input Short Circuit in Sensor Source Voltage

Byte	Bit	Description
Produces 0	00-07	Input Status bits: When the bit is set (1), the input is on. Bit 00 = to input 0, bit 01 = to input 1, bit 02 = to input 2, bit 03 = to input 3, bit 04 = to input 4, bit 05 = to input 5, bit 06 = to input 6, bit 07 = to input 7.
Produces 1	00-03 04-07	Input short circuit fault: ISC-A = a short circuit for connector A Input short circuit fault: ISC-B = a short circuit for connector B Input short circuit fault: ISC-C = a short circuit for connector C Input short circuit fault: ISC-D = a short circuit for connector D Input off wire fault: OW-A = an off-wire fault for connector A Input off wire fault: OW-B = an off-wire fault for connector B Input off wire fault: OW-C = an off-wire fault for connector C Input off wire fault: OW-D = an off-wire fault for connector D
Produces 2	00-07	Output no load or overload fault (OFLT): - When the bit is set (1) an output fault has occurred. OFLT0 = to output 0, OFLT1 = to output 1, OFLT2 corresponds to output 2, OFLT3 = to output 3, OFLT4 = to output 4, OFLT5 = to output 5, OFLT6 = to output 6, OFLT7 = to output 7.
Produces 3	00-05 06 07	RSVD = Reserved Output Power Fault (OPWR): When the bit is set (1) Auxiliary Power is not present. RSVD = Reserved
Consumes 0	00-07	Output bits: When the bit is set (1), the output will be turned on. Bit 00 corresponds to output 00, bit 01 corresponds to output 01, bit 02 to output 02, bit 03 to output 03, bit 04 to output 04, bit 05 to output 05, bit 06 to output 06, bit 07 to output 07.

The DeviceNet Network uses advanced network technology, producer/consumer communication, to increase network functionality and throughput. Visit our web site at <http://www.ab.com/networks> for producer/consumer technology information and updates.

Allen-Bradley A

Troubleshoot with the Indicators

This module has the following indicators:

- Network and Module status indicator
- Logic status indicator
- Auxiliary Power indicator
- Individual I/O status indicators for inputs 0 through 7 and outputs 0 through 7.

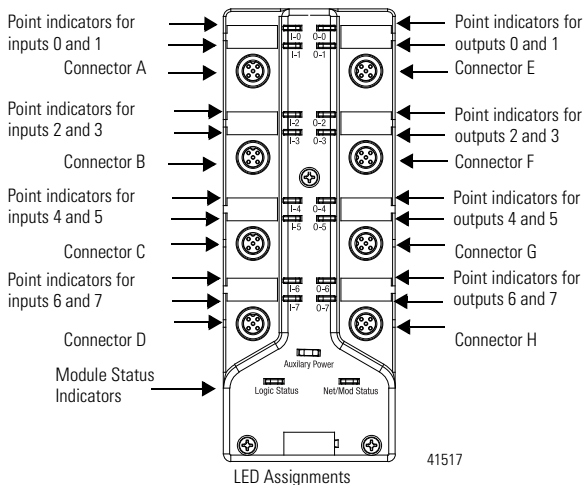

The following table describes network and module status indicators.

Net/Mod Status Indicator

Indicator	Status
Off	No power or auto bauding
Flashing Green/Off	On line but not connected
Solid Green	On line, link OK, connected
Flashing Red	Recoverable fault - module configuration error
	I/O connection fault - one or more I/O connections in the timed-out state

Net/Mod Status Indicator (continued)

Solid Red	Unrecoverable fault
	Communication failure - duplicate node address present or incorrect baud rate
Green to Red to Off	At powerup only - LED test

The following table describes logic status indicators.

Logic Status Indicators

State	Status
Off	Logic is disabled
Solid Green	Logic is enabled
Flashing Green	Local forces are applied and local logic is enabled

The following table describes auxiliary power indicators.

Auxiliary Power

Indication	Status
None	No Auxiliary Power
Green Solid	Auxiliary Power Present

The following table describes individual I/O status indicators.

I/O Status Indicators

Function	Module Status Indicator	Point Indicator ¹	Condition
Outputs	Green	None	Output not energized
	Green	Yellow	Output energized
	Module Status blink red	Orange	Output shorted-auto restart
	Module Status blink red	Red	Output shorted-latching
	Module Status blink red	Orange	Output no load-auto restart
Inputs	Module Status blink red	Red	Output no load-latching
	Green	None	No valid input
	Green	Yellow	Valid input
	Module Status blink red	Red	Short on input connector ¹
	Module Status blink red	Blink red	Off wire on input connector

¹Only the first LED of each input connector will light as red when twin inputs are used.

For more information on indications see the Technical Data publication 1792-TD001B-EN-P.

Allen-Bradley A

Specifications

8 Input / 8 Output Module - Cat. No. 1792D-8BVT8D		
Input Specifications	Max.	Min.
Inputs per block	8 - 3 wire or dry contact PNP or NPN devices or 4 - 4 wire PNP or NPN devices	
Sensor Source Current (per connector)	100mA total	-
Off-Wire Sense Current	0.5mA	-
On-state Voltage	25V dc	10V dc
On-state Current	10mA	2mA
Off-state Voltage	5V dc	-
Off-state Current	-	1.5mA
Output Specifications	Max.	Min.
Outputs per block	8 sourcing outputs labeled O0 through O7	
Off Peak Blocking Voltage	30V	10V
On-state Voltage Drop	1V	-
On-state Current	0.5A	-
Off-state Leakage	1.5mA	-
Module Current (all outputs)	4.0A	-
Surge Current - for 10ms, repeatable every 2s	2.4A	-
No Load Sense Current (On-state)	0.18A	-
General Specifications		
Indicators	Net/Mod Status - red/green Logic Status - red/green Auxiliary Power - green Point LED - yellow/orange/red	
Communication Rate	<ul style="list-style-type: none"> ●125Kbps @ 500 meters(1600 feet) for thick cable, flat media length 375 meters (1230 feet) ●250Kbps @ 200 meters(600 feet) for thick cable, flat media length 150 meters (492 feet) ●500Kbps @ 100 meters (330 feet) for thick cable, flat media length 75 meters (246 feet) 	
DeviceNet Power Voltage Current Refer to the graphs in the Overview section of the ArmorBlock I/O Family Technical Data, pub. no. 1792-TD001B-EN-P.	25V dc max 150mA max (no sensors)	11V dc min up to 1.4A (8 sensors @ 50mA per sensor)

8 Input / 8 Output Module - Cat. No. 1792D-8BVT8D**General Specifications**

Auxiliary Power	Voltage Current	30V dc max 4A max	10V dc min 4A max
Dimensions (assembled to base) inches - (Millimeters)	1.9H x 2.7W x 6.85D (48.26)H x (68.6)W x (174)D (millimeters)		
Environmental Conditions	Operational Temperature Storage Temperature Relative Humidity Shock Operating Non-operating Vibration		
	-25 to 60 ^o (-13 to 140 ^o F) -25 to 80 ^o C (-13 to 176 ^o F) 5 to 100% 30g peak acceleration, 11 (+1) ms pulse width 50g peak acceleration, 11(+1)ms pulse width Tested 10g @ 10-500Hz per IEC 68-2-6		
Conductors	Publication DN-6.7.2		
Enclosure	Meets or exceeds IP67		
Agency Certification (when product is marked)	CSA certified CSA Class 1, Division 2, Groups A, B, C, D certified UL listed CE marked for all applicable directives		
Technical Data (user information)	Publication 1792-TD001B-EN-P		

Allen-Bradley A

Hazardous Location Approval

The following information applies only to products marked with Hazardous Location Approval, when operating in hazardous locations:

Products marked “CL I, DIV 2, GP A, B, C, D” are suitable for use in Class I Division 2 Groups A, B, C, D, Hazardous Locations and nonhazardous locations only. Each product is supplied with markings on the rating nameplate indicating the hazardous location temperature code. When combining products within a system, the most adverse temperature code (lowest “T” number) may be used to help determine the overall temperature code of the system. Combinations of equipment in your system are subject to investigation by the local Authority Having Jurisdiction at the time of installation.

WARNING



EXPLOSION HAZARD -

- Do not disconnect equipment unless power has been removed or the area is known to be nonhazardous.
 - Do not disconnect connections to this equipment unless power has been removed or the area is known to be nonhazardous. Secure any external connections that mate to this equipment by using screws, sliding latches, threaded connectors, or other means provided with this product.
 - Substitution of components may impair suitability for Class I, Division 2.
 - If this product contains batteries, they must only be changed in an area known to be nonhazardous.
-

WARNING



Use supply wires suitable for 30°C above surrounding ambient.

WARNING

When used in a Class I, Division 2, hazardous location, this equipment must be mounted in a suitable enclosure with proper wiring method that complies with the governing electrical codes.

Les informations suivantes ne concernent que les produits marqués pour une utilisation en environnements dangereux :

Les produits marqués « CL I, DIV 2, GP A, B, C, D » ne conviennent qu'à une utilisation en environnements de Classe I Division 2 Groupes A, B, C, D dangereux et non dangereux. Chaque produit est livré avec des marquages sur sa plaque d'identification qui indiquent le code de température pour les environnements dangereux. Lorsque plusieurs produits sont combinés dans un système, le code de température le plus défavorable (code de température le plus faible) peut être utilisé pour déterminer le code de température global du système. Les combinaisons d'équipements dans le système sont sujettes à inspection par les autorités locales qualifiées au moment de l'installation.

AVERTISSEMENT**RISQUE D'EXPLOSION -**

- Couper le courant ou s'assurer que l'environnement est classé non dangereux avant de débrancher l'équipement.
- Couper le courant ou s'assurer que l'environnement est classé non dangereux avant de débrancher les connecteurs. Fixer tous les connecteurs externes reliés à cet équipement à l'aide de vis, loquets coulissants, connecteurs filetés ou autres moyens fournis avec ce produit.
- La substitution de composants peut rendre cet équipement inadapté à une utilisation en environnement de Classe I, Division 2.
- S'assurer que l'environnement est classé non dangereux avant de changer les piles.

AVERTISSEMENT

Utiliser des fils d'alimentation qui conviennent à une température de 30°C au-dessus de la température ambiante.

AVERTISSEMENT

Pour une utilisation en environnement de classe I, division 2 dangereux, cet équipement doit être monté dans un boîtier avec un câblage approprié conforme aux normes électriques en vigueur.

This product has been tested at an Open DeviceNet Vendor Association, Inc. (ODVA) authorized independent test laboratory and found to comply with ODVA Conformance Test. Please contact the ODVA website (<http://www.odva.org>) for listing of products tested by ODVA independent test labs for further details.

www.rockwellautomation.com

Power, Control and Information Solutions Headquarters

Americas: Rockwell Automation, 1201 South Second Street, Milwaukee, WI 53204-2496 USA, Tel: (1) 414.382.2000, Fax: (1) 414.382.4444
Europe/Middle East/Africa: Rockwell Automation, Vorstlaan/Boulevard du Souverain 36, 1170 Brussels, Belgium, Tel: (32) 2 663 0600, Fax: (32) 2 663 0640
Asia Pacific: Rockwell Automation, Level 14, Core F, Cyberport 3, 100 Cyberport Road, Hong Kong, Tel: (852) 2887 4788, Fax: (852) 2508 1846

Publication 1792D-IN020B-EN-P - September 2000

PN 957395-54

Supersedes Publication 1792D-5.20 - October 1998

© 2000 Rockwell International Corporation. Printed in USA