

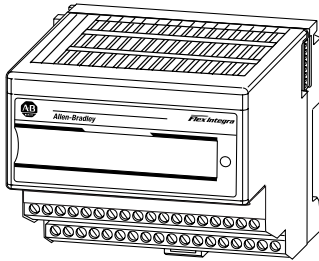

Installation Instructions

FLEX Integra 16 Source Input Module

(Cat. No. 1793-IV16 and -IV16S)



Module Installation

This module mounts on a DIN rail. It connects to an adapter or another FLEX I/O or Integra module. Note: If using this module with FLEX I/O modules, do not mount between FLEX I/O modules. Mount Integra modules to the right of the FLEX I/O modules. To mount this module:

1. Remove the cover plug (if used) in the male connector of the unit to which you are connecting this module.
2. Position the module on the 35 x 7.5mm DIN rail A (A-B pt. no. 199-DR1).
3. Rotate the module onto the DIN rail with the top of the rail hooked under the lip on the rear of the module.

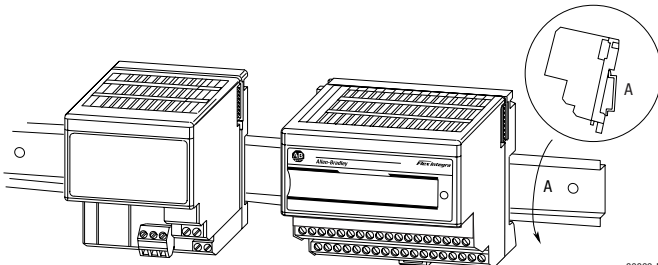

30869-M

4. Press down to lock the module on the DIN rail.

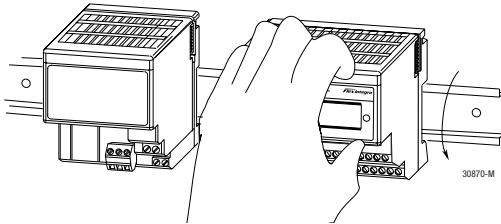

If the module does not lock in place, use a screwdriver of similar device to move the locking tab down, press the module flush with the DIN rail and release the locking tab to lock the module in place.

5. Firmly push the module into the adjacent module/terminal base until the units lock together.

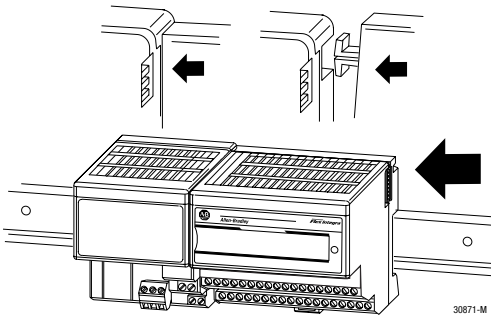

6. Repeat the above steps to install the next module.
7. To remove an Integra module, you must work from the right side and remove one module at a time. To disengage a module from its neighbor, place a common flat-bladed screwdriver between the 2 modules and turn 1/4 turn to separate the modules.

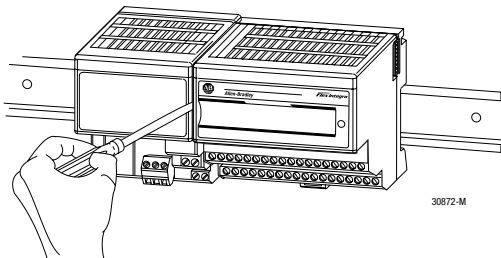

8. Then slide the module away from its left neighbor, and release the locking lever to remove the module from the DIN rail.



ATTENTION: Do not remove this module under power. Removing this module under power will break the electrical backplane (flexbus) connections. This can cause personal injury or property damage by:

- sending an erroneous signal to your system's field devices causing unintended machine motion
- causing an explosion in a hazardous environment
- breaking communication to modules beyond this module

European Union Directive Compliance

If this product has the CE mark it is approved for installation within the European Union and EEA regions. It has been designed and tested to meet the following directives.

EMC Directive

This product is tested to meet Council Directive 89/336/EEC Electromagnetic Compatibility (EMC) and the following standards, in whole or in part, documented in a technical construction file:

- EN 50081-2 EMC - Generic Emission Standard, Part 2 - Industrial Environment
- EN 50082-2 EMC - Generic Immunity Standard, Part 2 - Industrial Environment

This product is intended for use in an industrial environment.

Low Voltage Directive

This product is tested to meet Council Directive 73/23/EEC Low Voltage, by applying the safety requirements of EN 61131-2 Programmable Controllers, Part 2 - Equipment Requirements and Tests.

For specific information required by EN 61131-2, see the appropriate sections in this publication, as well as the following Allen-Bradley publications:

- Industrial Automation Wiring and Grounding Guidelines For Noise Immunity, publication 1770-4.1
- Automation Systems Catalog, publication B111

This equipment is classified as open equipment and must be mounted in an enclosure during operation to provide safety protection.

Wiring

This module is available with 2 styles of terminations: 1793-IV16 - screw-cage and 1793-IV16S - spring-clamp. Refer to the wiring figure below.

1793-IV16

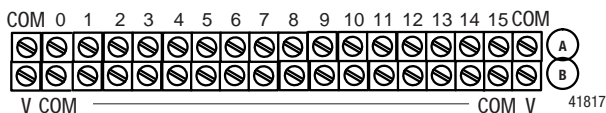

1793-IV16S

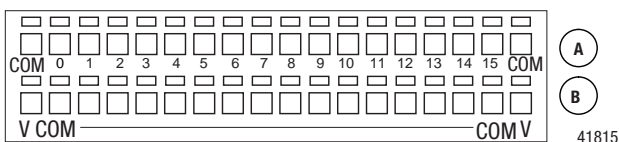

Where: COM = common, V = +24V dc power, 0 thru 15 = inputs

1. Connect individual sensor signal input leads to terminals 0 through 15 on row **A** (channels 0 thru 15 respectively).
2. Connect the associated sensor common lead to a **COM** terminal on row **(B)**.
3. Connect +24V dc voltage to **V** terminal on row **B**.
4. Connect 24V dc common to terminal **COM** on row **A**.
5. If daisy-chaining +24V dc from this module to the next Integra module, connect a jumper from terminal **V** to terminal 8 on the next 8 point Integra module or terminal **V** on the next 16 point Integra module.
6. If daisy-chaining 24V dc common from this module to the next FLEX Integra module, connect a jumper from terminal **COM** on this module to terminal 0 on the next 8 point Integra module, or to terminal **COM** on the next 16 point Integra module.



ATTENTION: Total current draw through the module's (V) voltage terminals is limited to 10A. Separate power connections to the module may be required.

Channel	Input	Common	Channel	Input	Common
0	0	connect to corresponding terminal on row B	8	8	connect to corresponding terminal on row B
1	1		9	9	
2	2		10	10	
3	3		11	11	
4	4		12	12	
5	5		13	13	
6	6		14	14	
7	7		15	15	
+24V dc	Power terminals V are internally connected together in the module.				
24V dc common	Common terminals COM are internally connected together in the module.				

Indicators

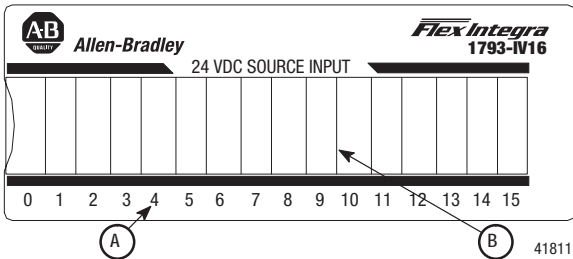

A = Status indicators - 0 through 15 - shows status of individual inputs

B = Insertable label for writing individual input designations

Memory Mapping

Bit/Word	15	14	13	12	11	10	09	08	07	06	05	04	03	02	01	00
Read	I15	I14	I13	I12	I11	I10	I9	I8	I7	I6	I5	I4	I3	I2	I1	I0
Write	Reserved										DT 12-15		DT 00-11			

Where: I = Input

DT = delay time - refer to "Setting the Input Delay Time"

Setting the Input Delay Time

You can select the input delay time (DT) for channels 00 thru 11 and channels 12 thru 15. Select the input delay time by setting the corresponding bits in the output image table (complementary word) for the module.

For example, to set a delay time of 4ms for an input module at address rack 1, module group 0, set bits 05, 04, 03, 02, 01 and 00 as shown below.

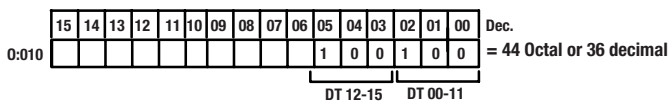

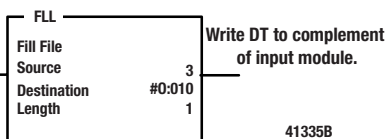

Write delay time on system startup.



Input Delay Times

02	01	00	Filter Time for Inputs 00-11	Selected Filter Time
05	04	03	Filter Time for Inputs 12-15	
0	0	0	Filter Time 0 (default)	250µs
0	0	1	Filter Time 1	500µs
0	1	0	Filter Time 2	1ms
0	1	1	Filter Time 3	2ms
1	0	0	Filter Time 4	4ms
1	0	1	Filter Time 5	8ms
1	1	0	Filter Time 6	16ms
1	1	1	Filter Time 7	32ms

Important: Input and output wiring must be in accordance with Class I, Division 2 wiring methods and in accordance with the authority having jurisdiction

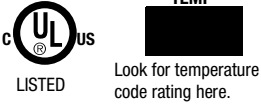
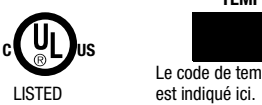
C-UL and UL Hazardous Location Approval	Approbation d'utilisation dans des environnements dangereux par la C-UL and UL
<p>C-UL and UL certifies products for general use as well as for use in hazardous locations. Actual C-UL and UL certification is indicated by the product label as shown below, and not by statements in any user documentation.</p>	<p>La C-UL and UL certifie des produits pour une utilisation générale aussi bien que pour une utilisation en environnements dangereux. La certification C-UL and UL en vigueur est indiquée par l'étiquette produit et non par des indications dans la documentation utilisateur.</p>
<p>Example of the C-UL and UL certification product label:</p> 	<p>Exemple d'étiquette de certification d'un produit par la C-UL and UL :</p> 
<p>To comply with C-UL and UL certification for use in hazardous locations, the following information becomes a part of the product literature for this C-UL and UL-certified industrial control product.</p> <ul style="list-style-type: none"> • This equipment is suitable for use in Class I, Division 2, Groups A, B, C, D, or non-hazardous locations only. • The products having the appropriate C-UL and UL markings (that is, Class I, Division 2, Groups A, B, C, D) are certified for use in other equipment where the suitability of combination (that is, application or use) is determined by the C-UL and UL or the local inspection office having jurisdiction • Peripheral equipment must be suitable for the location in which it is used. 	<p>EPour satisfaire à la certification C-UL and UL en environnements dangereux, les informations suivantes font partie intégrante de la documentation des produits de commande industrielle certifiés.</p> <ul style="list-style-type: none"> • Cet équipement ne convient qu'à une utilisation dans des environnements de Classe I, Division 2, Groupes A, B, C, D ou non dangereux. • Les produits portant le marquage C-UL and UL approprié (c'est-à-dire Classe I, Division 2, Groupes A, B, C, D) sont certifiés pour une utilisation avec d'autres équipements, les combinaisons d'applications et d'utilisation étant déterminées par la C-UL and UL ou le bureau local d'inspection. • L'équipement périphérique doit convenir à l'emplacement d'utilisation.
<p>Important: Due to the modular nature of a programmable control system, the product with the highest temperature rating determines the overall temperature code rating of a programmable control system in a Class I, Division 2, location. The temperature code rating is marked on the product label as shown.</p>	<p>Important: De par la nature modulaire des systèmes de commande programmables, le produit ayant le code de température le plus élevé détermine le code de température global du système dans un environnement de Classe I, Division 2. Le code de température est indiqué sur l'étiquette produit.</p>
<p>Temperature code rating:</p> 	<p>Code de température :</p> 
<p>The following warnings apply to products having C-UL and UL certification for use in hazardous locations.</p>	<p>Les avertissements suivants s'appliquent aux produits ayant la certification C-UL and UL pour une utilisation dans des environnements dangereux.</p>

C-UL and UL Hazardous Location Approval	Approbation d'utilisation dans des environnements dangereux par la C-UL and UL
<p>WARNING: Explosion Hazard</p> <ul style="list-style-type: none"> • Substitution of components may impair suitability for Class I, Division 2. • Do not replace components unless power has been switched off or the area is known to be non-hazardous. • Do not disconnect equipment unless power has been switched off or the area is known to be non-hazardous. • Do not disconnect connectors unless power has been switched off or the area is known to be non-hazardous. Secure any user-supplied connectors that mate to external circuits on this equipment by using screws, sliding latches, threaded connectors, or other means such that any connection can withstand a 15 Newton (3.4 lb.) separating force applied for a minimum of one minute. • Batteries must only be changed in an area known to be non-hazardous. 	<p>AVERTISSEMENT : Risque d'explosion</p> <ul style="list-style-type: none"> • La substitution de composants peut rendre ce matériel inadapté à une utilisation en environnement de Classe I, Division 2. • Couper le courant ou s'assurer que l'environnement est classé non dangereux avant de remplacer des composants. • Couper le courant ou s'assurer que l'environnement est classé non dangereux avant de débrancher l'équipement. • Couper le courant ou s'assurer que l'environnement est classé non dangereux avant de débrancher les connecteurs. Fixer tous les connecteurs fournis par l'utilisateur pour se brancher aux circuits externes de cet appareil à l'aide de vis, loquets coulissants, connecteurs filetés ou autres, de sorte que les connexions résistent à une force de séparation de 15 Newtons (1,5 kg - 3,4 lb.) appliquée pendant au moins une minute. • S'assurer que l'environnement est classé non dangereux avant de changer les piles.
<p>C-UL and UL logo is a registered trademark of the Underwriters Laboratories.</p>	<p>Le sigle C-UL and UL est une marque déposée de la Underwriters Laboratories.</p>

Specifications - 16 Input Module Cat. No. 1793-IV16 and -IV16S

Module Type	16 digital input - sourcing 1793-IV16 - screw-cage terminations 1793-IV16S - spring-clamp terminations
Module Location	DIN rail mounting
Number of Channels	1 group of 16, nonisolated, sourcing
On-state Voltage	10 dc minimum 24V dc nominal 31.2V dc maximum
On-state Current	2mA minimum 8.8mA nominal at 24V dc 12.1mA maximum
Off-state Voltage	5V dc maximum
Off-state Current	1.5mA minimum
Input Impedance	2.5K Ω
Isolation Voltage	100% tested at 850V dc for 1s between user and system No isolation between individual channels
Input Delay - selectable Off to On On to Off	Minimum of 1ms plus selected filter time of: 250 μ s, 500 μ s, 1ms, 2ms, 4ms, 8ms, 16ms, and 32ms 250 μ s, 500 μ s, 1ms, 2ms, 4ms, 8ms, 16ms, and 32ms Default = 250 μ s selectable thru output image table
Flexbus Current	25mA maximum
Power Dissipation	6.1W @ 31.2V dc
Thermal Dissipation	20.8 BTU/hr @ 31.2V dc
Indicators	16 yellow channel status indicators
External dc Power Voltage	19.2-31.2V dc (5% ac ripple)
Dimensions Inches (Millimeters)	2.72H x 3.7D x 3.2W (69H x 94D x 80W)
Environmental Conditions Operational Temperature Storage Temperature Relative Humidity Shock Operating Nonoperating Vibration	0 to +55 $^{\circ}$ C (32 to +131 $^{\circ}$ F) -40 to +85 $^{\circ}$ C (-40 to +185 $^{\circ}$ F) 5 to 95% noncondensing Tested to 30g peak acceleration, 11(\pm 1)ms pulse width Tested to 50g peak acceleration, 11(\pm 1)ms pulse width Tested 5g @ 10-500Hz per IEC68-2-6

Specifications - 16 Input Module Cat. No. 1793-IV16 and -IV16S

Conductors Wire Size Category	12 gauge to 18 gauge (4mm ² to 0.75mm ²) stranded wire rated @ 75°C minimum 3/64 in (1.2mm) maximum insulation 2 ¹
Screw Terminal Torque	5-7 lb-in (0.5-0.6Nm)
Agency Certification (when product is marked)	<ul style="list-style-type: none"> • C-UL Listed • C-UL Class I, Division 2 Groups A, B, C and D certified • UL listed • CE marked for all applicable directives • C-Tick marked for all applicable acts

¹Use this category information for planning conductor routing as described in publication 1770-4.1, "Wiring and Grounding Guidelines for Noise Immunity."

Derating Curve

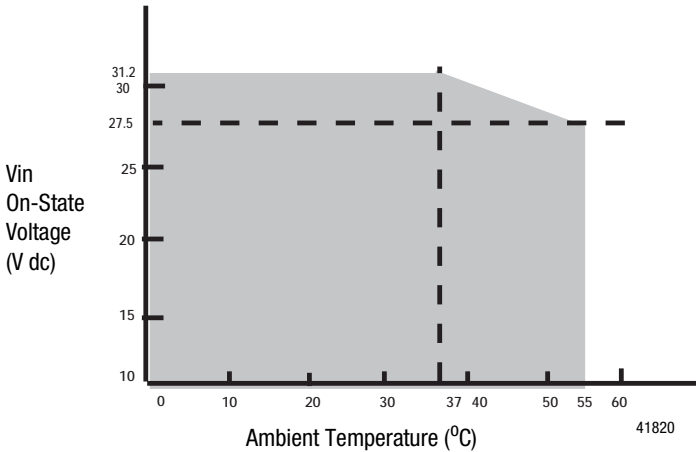

Reach us now at www.rockwellautomation.com

Wherever you need us, Rockwell Automation brings together leading brands in industrial automation including Allen-Bradley controls, Reliance Electric power transmission products, Dodge mechanical power transmission components, and Rockwell Software. Rockwell Automation's unique, flexible approach to helping customers achieve a competitive advantage is supported by thousands of authorized partners, distributors and system integrators around the world.

Americas Headquarters, 1201 South Second Street, Milwaukee, WI 53204, USA, Tel: (1) 414 382-2000, Fax: (1) 414 382-4444
European Headquarters SA/NV, avenue Hermann Debroux, 46, 1160 Brussels, Belgium, Tel: (32) 2 663 06 00, Fax: (32) 2 663 06 40
Asia Pacific Headquarters, 27/F Citicorp Centre, 18 Whitfield Road, Causeway Bay, Hong Kong, Tel: (852) 2387 4788, Fax: (852) 2508 1846

Publication 1793-5.10 - December 1999

Supersedes publication 1793-5.10 - September 1999



**Rockwell
Automation**

PN 957259-17

© (1999) Rockwell International Corporation. Printed in USA