

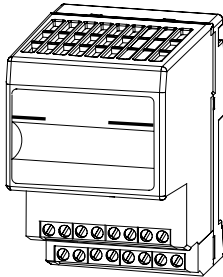

## Installation Instructions

# FLEX Integra 4 Input Analog Module

(Cat. No. 1793-IE4 and -IE4S)



41355

### Module Installation

This module mounts on a DIN rail. It connects to an adapter or another FLEX I/O or Integra module. Note: If using this module with FLEX I/O modules, do not mount between FLEX I/O modules. Mount Integra modules to the right of the FLEX I/O modules. To mount this module::

1. Remove the cover plug (if used) in the male connector of the unit to which you are connecting this module.
2. Position the module on the 35 x 7.5mm DIN rail **A** (A-B pt. no. 199-DR1). Rotate the module onto the DIN rail with the top of the rail hooked under the lip on the rear of the module.

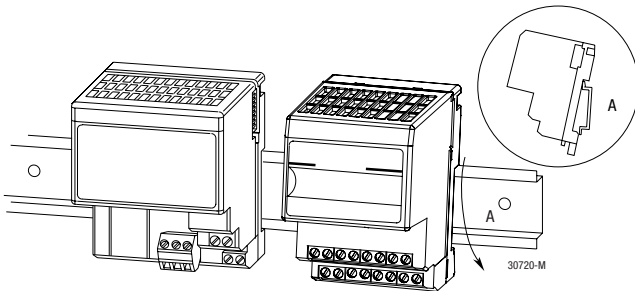

3. Press down to lock the module on the DIN rail.

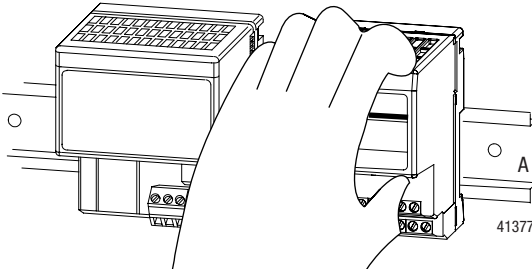

If the module does not lock in place, use a screwdriver of similar device to move the locking tab down, press the module flush with the DIN rail and release the locking tab to lock the module in place

4. Firmly push the module into the adjacent module/terminal base until the units lock together.

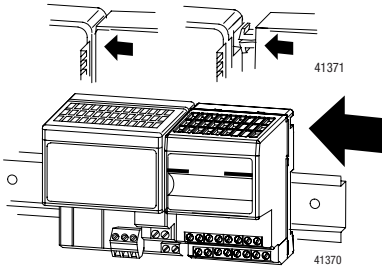

5. Repeat the above steps to install the next Integra module.
6. To remove an Integra module, you must work from the right side and remove one module at a time. To disengage a module from its neighbor, place a common flat-bladed screwdriver between the 2 modules and turn 1/4 turn to separate the modules.

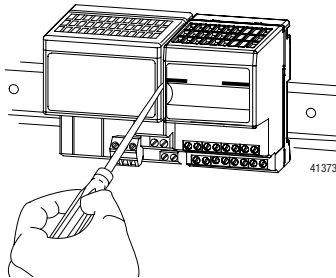

7. Then slide the module away from its left neighbor, and release the locking lever to remove the module from the DIN rail.



**ATTENTION: Do not remove this module under power.** Removing this module under power will break the electrical backplane (flexbus) connections. This can cause personal injury or property damage by:

- sending an erroneous signal to your system's field devices causing unintended machine motion
  - causing an explosion in a hazardous environment
  - breaking communication to modules beyond this module
- 

## European Union Directive Compliance

If this product has the CE mark it is approved for installation within the European Union and EEA regions. It has been designed and tested to meet the following directives.

### EMC Directive

This product is tested to meet Council Directive 89/336/EEC Electromagnetic Compatibility (EMC) and the following standards, in whole or in part, documented in a technical construction file:

- EN 50081-2 EMC - Generic Emission Standard, Part 2 - Industrial Environment
- EN 50082-2 EMC - Generic Immunity Standard, Part 2 - Industrial Environment

This product is intended for use in an industrial environment.

### Low Voltage Directive

This product is tested to meet Council Directive 73/23/EEC Low Voltage, by applying the safety requirements of EN 61131-2 Programmable Controllers, Part 2 - Equipment Requirements and Tests.

For specific information required by EN 61131-2, see the appropriate sections in this publication, as well as the following Allen-Bradley publications:

- Industrial Automation Wiring and Grounding Guidelines For Noise Immunity, publication 1770-4.1
- Automation Systems Catalog, publication B111

This equipment is classified as open equipment and must be mounted in an enclosure during operation to provide safety protection.

## Wiring

This module is available with 2 styles of connectors; screw-cage and spring clamp. Refer to the wiring figure below.

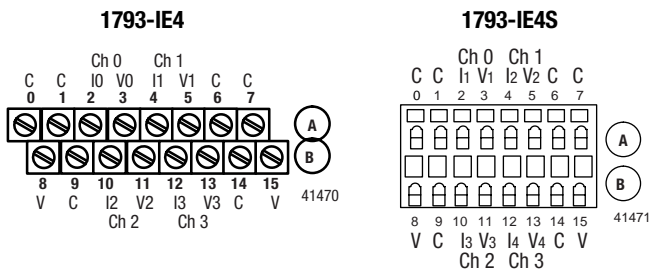

Where: C = 24V dc common, V = 24V dc power, I<sub>n</sub> = current in, V<sub>n</sub> = voltage in.

1. Connect individual analog channel signal wiring to terminals on row **A** and row **C**. Use **Belden 8761 cable for signal wiring**.



**ATTENTION:** Connect only 1 current or 1 voltage signal per channel. Do not connect both current and voltage on 1 channel.

2. Connect the associated channel common to common terminals 1, 6, 9 or 14 according to the wiring table on the next page.
3. Connect +24V dc to terminal 8 on row **B**.
4. Connect 24V dc common to terminal 0 on row **A**.
5. If daisy-chaining +24V dc from this module to the next FLEX Integra module, connect a jumper from terminal 15 to terminal 8 on the next FLEX Integra module.
6. If daisy-chaining 24V dc common from this module to the next FLEX Integra module, connect a jumper from terminal 7 on this module to terminal 0 on the next Integra module.



**ATTENTION:** Total current draw through the module's 24V dc terminals is limited to 10A. Separate power connections to the module may be required.

## Wiring Connections

Channel	Signal Type	Label Markings	Signal	Return
0	Current	I	2	1
	Voltage	V	3	
1	Current	I	4	6
	Voltage	V	5	
2	Current	I	10	9
	Voltage	V	11	
3	Current	I	12	14
	Voltage	V	13	
+24V dc	Terminals 8 and 15 are internally connected together in the module.			
24V dc common	Terminals 0, 1, 6, 7, 9, 14 are internally connected together in the module.			

## Examples of Sensor Wiring

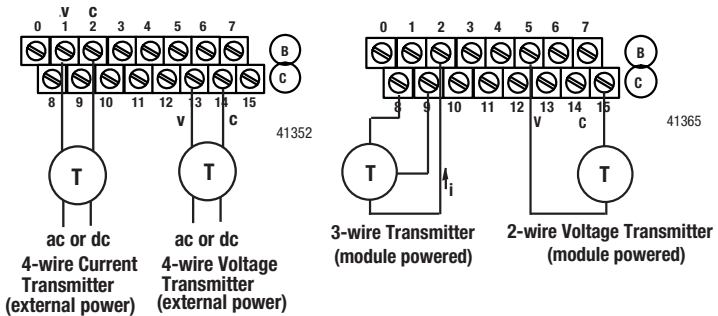

## Indicators

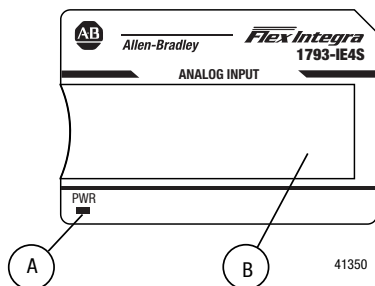

**A** = Power indicator - indicates power applied to module

**B** = Insertable label for writing individual output designations

## Input Map

Bit/ Word	15	14	13	12	11	10	09	08	07	06	05	04	03	02	01	00
<b>Read</b>																
0	S	Analog Input Value for Channel 0														
1	S	Analog Input Value for Channel 1														
2	S	Analog Input Value for Channel 2														
3	S	Analog Input Value for Channel 3														
4-7	Reserved															
8	PU											U3	U2	U1	U0	

Where: S = Sign bit  
 PU = Power up bit  
 U = Underrange bit

## Output Map

Bit/ Word	15	14	13	12	11	10	09	08	07	06	05	04	03	02	01	00
<b>Write</b>																
0	Reserved				C3	C2	C1	C0	Reserved				F3	F2	F1	F0

Where: F = Full Range bit  
 C = Configure Select bit



## Range Selection Bits

Channel No.	Ch. 0		Ch. 1		Ch. 2		Ch. 3	
	F0	C0	F1	C1	F2	C2	F3	C3
<b>Dec.Bit</b>	<b>00</b>	<b>08</b>	<b>01</b>	<b>09</b>	<b>02</b>	<b>10</b>	<b>03</b>	<b>11</b>
<b>Write</b>								
0-10V dc/20mA	1	0	1	0	1	0	1	0
4-20mA	0	1	0	1	0	1	0	1
-10 to +10V dc	1	1	1	1	1	1	1	
Off <sup>1</sup>	0	0	0	0	0	0	0	0

Where: F = Full Range bit

C = Configure Select bit

1 When configured to Off, individual input channels will return 0000H

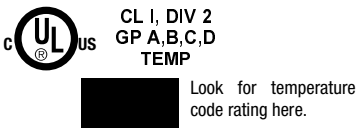
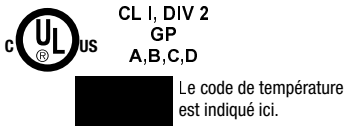
CUL Hazardous Location Approval	Approbation d'utilisation dans des environnements dangereux par la CUL
<p>CUL certifies products for general use as well as for use in hazardous locations. <b>Actual CUL certification is indicated by the product label</b> as shown below, and not by statements in any user documentation.</p>	<p>La CUL certifie des produits pour une utilisation générale aussi bien que pour une utilisation en environnements dangereux. La certification CUL en vigueur est indiquée par l'étiquette produit et non par des indications dans la documentation utilisateur.</p>
<p>Example of the CUL certification product label:</p> 	<p>Exemple d'étiquette de certification d'un produit par la CUL :</p> 
<p>To comply with CUL certification for use in hazardous locations, the following information becomes a part of the product literature for this CUL-certified industrial control product.</p> <ul style="list-style-type: none"> <li>• This equipment is suitable for use in Class I, Division 2, Groups A, B, C, D, or non-hazardous locations only.</li> <li>• The products having the appropriate CUL markings (that is, Class I, Division 2, Groups A, B, C, D) are certified for use in other equipment where the suitability of combination (that is, application or use) is determined by the CUL or the local inspection office having jurisdiction</li> </ul>	<p>EPour satisfaire à la certification CUL en environnements dangereux, les informations suivantes font partie intégrante de la documentation des produits de commande industrielle certifiés.</p> <ul style="list-style-type: none"> <li>• Cet équipement ne convient qu'à une utilisation dans des environnements de Classe I, Division 2, Groupes A, B, C, D ou non dangereux.</li> <li>• Les produits portant le marquage CUL approprié (c'est-à-dire Classe I, Division 2, Groupes A, B, C, D) sont certifiés pour une utilisation avec d'autres équipements, les combinaisons d'applications et d'utilisation étant déterminées par la CUL ou le bureau local d'inspection.</li> </ul>
<p>Important: Due to the modular nature of a programmable control system, the product with the highest temperature rating determines the overall temperature code rating of a programmable control system in a Class I, Division 2, location. The temperature code rating is marked on the product label as shown.</p>	<p>Important: De par la nature modulaire des systèmes de commande programmables, le produit ayant le code de température le plus élevé détermine le code de température global du système dans un environnement de Classe I, Division 2. Le code de température est indiqué sur l'étiquette produit.</p>
<p>Temperature code rating:</p> 	<p>Code de température :</p> 
<p>The following warnings apply to products having CUL certification for use in hazardous locations.</p>	<p>Les avertissements suivants s'appliquent aux produits ayant la certification CUL pour une utilisation dans des environnements dangereux.</p>



CUL Hazardous Location Approval	Approbation d'utilisation dans des environnements dangereux par la CUL
<p><b>ATTENTION: Explosion Hazard</b></p> <ul style="list-style-type: none"> <li>• Substitution of components may impair suitability for Class I, Division 2.</li> <li>• Do not replace components unless power has been switched off or the area is known to be non-hazardous.</li> <li>• Do not disconnect equipment unless power has been switched off or the area is known to be non-hazardous.</li> <li>• Do not disconnect connectors unless power has been switched off or the area is known to be non-hazardous. Secure any user-supplied connectors that mate to external circuits on this equipment by using screws, sliding latches, threaded connectors, or other means such that any connection can withstand a 15 Newton (3.4 lb.) separating force applied for a minimum of one minute.</li> <li>• Batteries must only be changed in an area known to be non-hazardous.</li> </ul>	<p><b>AVERTISSEMENT : Risque d'explosion</b></p> <ul style="list-style-type: none"> <li>• La substitution de composants peut rendre ce matériel inadapté à une utilisation en environnement de Classe I, Division 2.</li> <li>• Couper le courant ou s'assurer que l'environnement est classé non dangereux avant de remplacer des composants.</li> <li>• Couper le courant ou s'assurer que l'environnement est classé non dangereux avant de débrancher l'équipement.</li> <li>• Couper le courant ou s'assurer que l'environnement est classé non dangereux avant de débrancher les connecteurs. Fixer tous les connecteurs fournis par l'utilisateur pour se brancher aux circuits externes de cet appareil à l'aide de vis, loquets coulissants, connecteurs filetés ou autres, de sorte que les connexions résistent à une force de séparation de 15 Newtons (1,5 kg - 3,4 lb.) appliquée pendant au moins une minute.</li> <li>• S'assurer que l'environnement est classé non dangereux avant de changer les piles.</li> </ul>
<p>CUL logo is a registered trademark of the Underwriters Laboratories.</p>	<p>Le sigle CUL est une marque déposée de la Underwriters Laboratories.</p>

<b>Specifications - 4 Input Analog Module, Cat. No. 1793-IE4 and -IE4S</b>	
Module Type	4 analog inputs 1793-IE4 - 16 screw-cage terminals 1793-IE4S - 16 spring-clamp terminals
Module Location	DIN rail mounting
Number of Channels	4
Data Format	16-bit 2's complement, left-justified
Conversion Type	Successive approximation
Conversion Rate	256 $\mu$ s all channels
Resolution	12-bits - unipolar; 11-bit plus sign - bipolar
Voltage	2.56mV/cnt unipolar; 5.13mV/cnt bipolar
Current	5.13 $\mu$ A/cnt
Input Current Terminal	4-20mA (user configurable) 0-20mA (user configurable)
Input Voltage Terminal	$\pm$ 10V (user configurable) 0-10V (user configurable)
Normal Mode Rejection Ratio	
Voltage Terminal	-3db @ 17Hz; -20db/decade -10db @ 50Hz; -11.4db @ 60Hz
Current Terminal	-3db @ 17Hz; -20db/decade -15.3db @ 50Hz; -16.8db @ 60Hz
Step Response to 63%	
Voltage Terminal	9.4ms
Current Terminal	18.2ms
Impedance	
Voltage Terminal	100K $\Omega$ ; 200K $\Omega$ @ dc
Current Terminal	238 $\Omega$
Absolute Accuracy	
Voltage Terminal	0.20% FS @ 25 $^{\circ}$ C
Current Terminal	0.20% FS @ 25 $^{\circ}$ C
Accuracy Drift	
Voltage Terminal	0.00428% FS per $^{\circ}$ C
Current Terminal	0.00407% FS per $^{\circ}$ C
Maximum Overload	Single channel, continuous
Voltage Terminal	30V
Current Terminal	32mA
Isolation Voltage	Channel to system - 850V dc for 1s Channel to channel - None
Flexbus Current	20mA maximum
Power Dissipation	1.0W @ 31.2V dc

<b>Specifications - 4 Input Analog Module, Cat. No. 1793-IE4 and -IE4S</b>		
Thermal Dissipation		3.4 BTU/hr @ 31.2V dc
Indicators		1 green power indicators
External dc Power	Voltage Current	19.2-31.2V dc (5% ac ripple) 60mA maximum
Dimensions	in (mm)	2.72H x 3.15D x 2.17W (69H x 80D x 55W)
Environmental Conditions		
	Operational Temperature	0 to +55°C (32 to +131°F)
	Storage Temperature	-40 to +85°C (-40 to +185°F)
	Relative Humidity	5 to 95% noncondensing
	Shock	Tested to 30g peak acceleration, 11(±1)ms pulse width
	Operating	
	Nonoperating	Tested to 50g peak acceleration, 11(±1)ms pulse width
	Vibration	Tested 5g @ 10-500Hz per IEC68-2-6
Conductors	Wire Size	12 gauge (4mm <sup>2</sup> ) stranded wire
	Category	3/64 in (1.2mm) maximum insulation 2
Screw Terminal Torque		7-9 lb-in
Agency Certification (when product is marked)		<ul style="list-style-type: none"> <li>• CUL Listed</li> <li>• CUL Class I, Division 2 Groups A, B, C and D certified</li> <li>• UL listed</li> <li>• CE marked for all applicable directives</li> </ul>
User Manual		• Publication 1793-6.5.1

1 Use this category information for planning conductor routing as described in publication 1770-4.1, "Wiring and Grounding Guidelines for Noise Immunity."

## User Manual

Thank you for purchasing this product. This product has a user manual associated with it. If you would like a manual, you can:

- download a free electronic version from the internet: [www.ab.com/manuals](http://www.ab.com/manuals) or [www.theautomationbookstore.com](http://www.theautomationbookstore.com)
- purchase a printed manual by:
  - contacting your local distributor or Rockwell Automation representative
  - visiting [www.theautomationbookstore.com](http://www.theautomationbookstore.com) and placing your order
  - calling 1.800.9NEWLIT(800.963.9548) (USA/Canada) or 001.330.725.1574 (Outside USA/Canada)

The publication number of the user manual for your product is listed under “Specifications” in this installation instruction.

---

### Reach us now at [www.rockwellautomation.com](http://www.rockwellautomation.com)

Wherever you need us, Rockwell Automation brings together leading brands in industrial automation including Allen-Bradley controls, Reliance Electric power transmission products, Dodge mechanical power transmission components, and Rockwell Software. Rockwell Automation's unique, flexible approach to helping customers achieve a competitive advantage is supported by thousands of authorized partners, distributors and system integrators around the world.

**Americas Headquarters**, 1201 South Second Street, Milwaukee, WI 53204, USA, Tel: (1) 414 382-2000, Fax: (1) 414 382-4444  
**European Headquarters SA/NV**, avenue Herrmann Debroux, 46, 1160 Brussels, Belgium, Tel: (32) 2 663 06 00, Fax: (32) 2 663 06 40  
**Asia Pacific Headquarters**, 27/F Citicorp Centre, 18 Whitfield Road, Causeway Bay, Hong Kong, Tel: (852) 2887 4788, Fax: (852) 2508 1846

Publication 1793-5.4 - June 1999

Supersedes Publication 1793-5.4 - December 1998



**Rockwell  
Automation**

PN 955132-17A

© (1999) Rockwell International Corporation. Printed in USA