

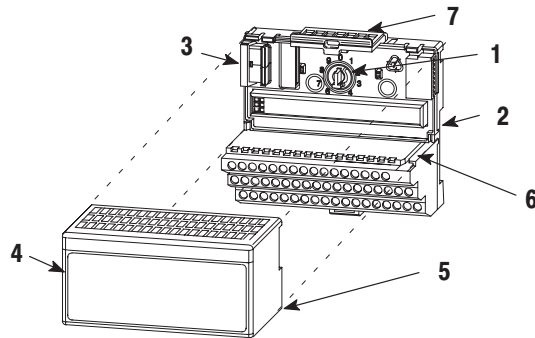

## Installation Instructions

### 24V dc FLEX I/O 16 Sink Input Module (Cat. No. 1794-IB16)



#### Module Installation

This module mounts on a 1794 terminal base unit.

1. Rotate keyswitch (1) on terminal base unit (2) clockwise to position 2 as required for this type of module.
2. Make certain the flexbus connector (3) is pushed all the way to the left to connect with the neighboring terminal base/adaptor. **You cannot install the module unless the connector is fully extended.**
3. Make sure that the pins on the bottom of the module are straight so they will align properly with the connector in the terminal base unit.

#### WARNING



If you remove or insert the module while the backplane power is on, an electrical arc can occur. This could cause an explosion in hazardous location installations. Be sure that power is removed or the area is nonhazardous before proceeding.

4. Position the module (4) with its alignment bar (5) aligned with the groove (6) on the terminal base.
5. Press firmly and evenly to seat the module in the terminal base unit. The module is seated when the latching mechanism (7) is locked into the module.

FLEX I/O is a trademark of  
Rockwell Automation

Publication 1794-IN072C-EN-P - October 2001

Allen-Bradley Parts

**ATTENTION**



To use this module in a complementary I/O system, refer to your Remote I/O Adapter module documentation.

---

**Important User Information**

Because of the variety of uses for the products described in this publication, those responsible for the application and use of these products must satisfy themselves that all necessary steps have been taken to assure that each application and use meets all performance and safety requirements, including any applicable laws, regulations, codes and standards. In no event will Allen–Bradley be responsible or liable for indirect or consequential damage resulting from the use or application of these products.

Any illustrations, charts, sample programs, and layout examples shown in this publication are intended solely for purposes of example. Since there are many variables and requirements associated with any particular installation, Allen–Bradley does not assume responsibility or liability (to include intellectual property liability) for actual use based upon the examples shown in this publication.

Allen–Bradley publication SGI–1.1, Safety Guidelines for Application, Installation, and Maintenance of Solid–State Control (available from your local Allen–Bradley office), describes some important differences between solid–state equipment and electromechanical devices that should be taken into consideration when applying products such as those described in this publication.

Reproduction of the contents of this copyrighted publication, in whole or part, without written permission of Rockwell Automation, is prohibited.

Throughout this publication, notes may be used to make you aware of safety considerations. The following annotations and their accompanying statements help you to identify a potential hazard, avoid a potential hazard, and recognize the consequences of a potential hazard.

---

**WARNING**



Identifies information about practices or circumstances that can cause an explosion in a hazardous environment, which may lead to personal injury or death, property damage, or economic loss.

---

**IMPORTANT**

Identifies information that is critical for successful application and understanding of the product.

---

**ATTENTION**



Identifies information about practices or circumstances that can lead to personal injury or death, property damage, or economic loss.

---

**ATTENTION**



**Environment and Enclosure**

This equipment is intended for use in a Pollution Degree 2 industrial environment, in overvoltage Category II applications (as defined in IEC publication 60664-1), at altitudes up to 2000 meters without derating.

This equipment is considered Group 1, Class A industrial equipment according to IEC/CISPR Publication 11. Without appropriate precautions, there may be potential difficulties ensuring electromagnetic compatibility in other environments due to conducted as well as radiated disturbance.

This equipment is supplied as “open type” equipment. It must be mounted within an enclosure that is suitably designed for those specific environmental conditions that will be present, and appropriately designed to prevent personal injury resulting from accessibility to live parts. The interior of the enclosure must be accessible only by the use of a tool. Subsequent sections of this publication may contain additional information regarding specific enclosure type ratings that are required to comply with certain product safety certifications.

See NEMA Standards publication 250 and IEC publication 60529, as applicable, for explanations of the degrees of protection provided by different types of enclosures. Also, see the appropriate sections in this publication, as well as the Allen-Bradley publication 1770-4.1, (“Industrial Automation Wiring and Grounding Guidelines”), for additional installation requirements pertaining to this equipment.

---

**ATTENTION**



**Preventing Electrostatic Discharge**

This equipment is sensitive to electrostatic discharge, which can cause internal damage and affect normal operation. Follow these guidelines when you handle this equipment:

- Touch a grounded object to discharge potential static.
- Wear an approved grounding wriststrap.
- Do not touch connectors or pins on component boards.
- Do not touch circuit components inside the equipment.
- If available, use a static-safe workstation.
- When not in use, keep modules in appropriate static-safe packaging.

**ATTENTION**



Remove field-side power before removing or inserting this module. This module is designed so you can **remove and insert it under backplane power**. When you remove or insert a module with field-side power applied, an electrical arc may occur. An electrical arc can cause personal injury or property damage by:

- sending an erroneous signal to your system's field devices causing unintended machine motion
- causing an explosion in a hazardous environment

Repeated electrical arcing causes excessive wear to contacts on both the module and its mating connector. Worn contacts may create electrical resistance.

### Wiring to a 1794-TB3 or -TB3S Terminal Base Unit

#### WARNING



If you connect or disconnect wiring while the field side power is on, an electrical arc can occur. This could cause an explosion in hazardous location installations. Be sure that power is removed or the area is nonhazardous before proceeding.

1. Connect individual input wiring to numbered terminals on the **0–15** row (**A**) as indicated in the table below.
2. Connect the associated +V dc power lead of the input device to the corresponding terminal on the 34–51 row (**C**) for each input as indicated in the table below. (The +V dc power terminals of row (**C**) are internally connected together.)
3. Connect the associated input common (3-wire devices only) to the corresponding terminal on the 16–33 row (**B**) for each input as indicated in the table below. (Commons are internally connected together.)
4. Connect +V dc power to terminal 34 on the **34–51** row (**C**).
5. Connect dc return to terminal 16 on the **16–33** row (**B**).
6. If continuing power to the next terminal base unit, connect a jumper from terminal 51 (+V dc) on this base unit to terminal 34 on the next base unit.
7. If continuing common to the next terminal base unit, connect a jumper from terminal 33 (common) on this base unit to terminal 16 on the next base unit.

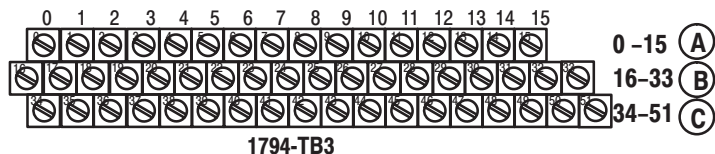

6 24V dc FLEX I/O 16 Sink Input Module

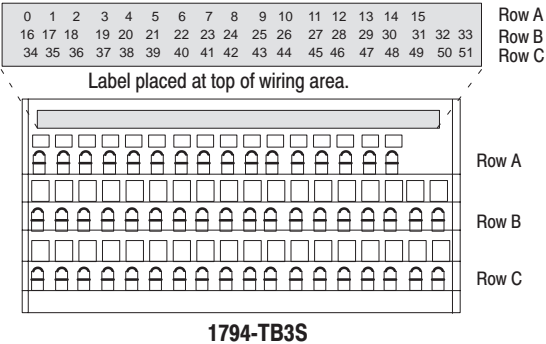

**ATTENTION**



Total current draw through the terminal base unit is limited to 10A. Separate power connections to the terminal base unit may be necessary.

Input	Input Terminal	Voltage Terminal	Common Terminal <sup>1</sup>
Input 0	A-0	C-35	B-17
Input 1	A-1	C-36	B-18
Input 2	A-2	C-37	B-19
Input 3	A-3	C-38	B-20
Input 4	A-4	C-39	B-21
Input 5	A-5	C-40	B-22
Input 6	A-6	C-41	B-23
Input 7	A-7	C-42	B-24
Input 8	A-8	C-43	B-25
Input 9	A-9	C-44	B-26
Input 10	A-10	C-45	B-27
Input 11	A-11	C-46	B-28
Input 12	A-12	C-47	B-29
Input 13	A-13	C-48	B-30
Input 14	A-14	C-49	B-31
Input 15	A-15	C-50	B-32
+V dc	C-34 thru C-51 (1794-TB3, -TB3S)		
Common	B-16 thru B-33		

<sup>1</sup> 3-wire devices only

**2-wire and 3-wire Inputs to the 1794-IB16 FLEX I/O Module (-TB3 shown)**

- 0 - 15 (A)
- 16 - 33 (B)
- 34 - 51 (C)

- (A) = Sink Input
- (B) = Common
- (C) = 24V dc

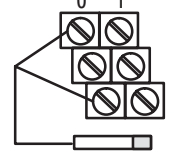
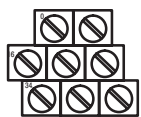

**2-Wire Device  
(Sourcing Output)**

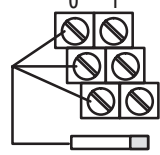

**3-Wire Device  
(Sourcing Output)**

**Indicators**

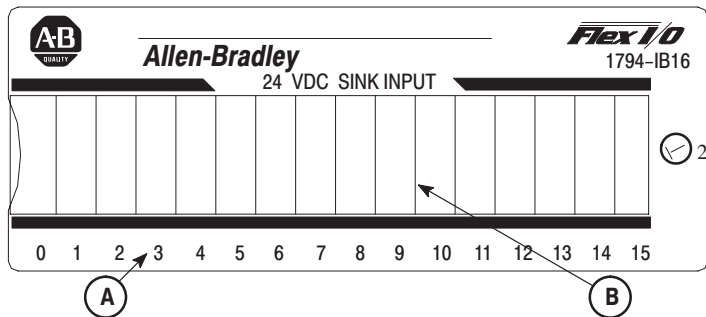

**A** = Status indicators – yellow – show status of individual inputs.

**B** = Insertable label for writing individual input designations.

**Memory Map**

<b>Dec.</b>	15	14	13	12	11	10	09	08	07	06	05	04	03	02	01	00
<b>Octal</b>	17	16	15	14	13	12	11	10	07	06	05	04	03	02	01	00
Read 0	D	D	D	D	D	D	D	D	D	D	D	D	D	D	D	D
	15	14	13	12	11	10	9	8	7	6	5	4	3	2	1	0
Read 1	C = 16 bit Counter Value of Input 15															
Write	Not used	CF	CR	Not used							FT 12-15			FT 00-11		

Where: D = Data Input - 0 = input off, 1 = input on  
 C = Counter value for input 15  
 FT = Input Filter Time  
 CR = Counter Reset  
 CF = Counter Fast - where 1 = Fast Input (raw) data, 0 = Standard Input filtered data  
 NOTE: C, CR and CF not available when used with any series 1794-ASB or 1794-ASB2 Remote I/O Adapter Modules



### Setting the Input Filter Time

You can select the input filter time (FT) for each group of channels (channels 00 through 11, or channels 12 through 15). Select the input filter time by setting the corresponding bits in the **output** image table (complementary word) for the module.

For example, to set a filter time of 4ms for a dc input module at address rack 1, module group 0, set bits 05, 04, 03, 02, 01, and 00 as shown below.

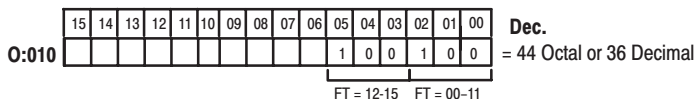

Write Filter Time on system startup.

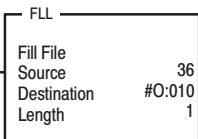
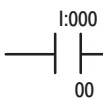

Write FT to complement of input module.

### Input Filter Times

Bits			Description	Selected Filter Time
<b>02</b>	<b>01</b>	<b>00</b>	<b>Filter Time for Inputs 00-11 (00-13)</b>	
<b>05</b>	<b>04</b>	<b>03</b>	<b>Filter Time for Inputs 12-15 (14-17)</b>	
0	0	0	Filter Time 0 (default)	256µs
0	0	1	Filter Time 1	512µs
0	1	0	Filter Time 2	1ms
0	1	1	Filter Time 3	2ms
1	0	0	Filter Time 4	4ms
1	0	1	Filter Time 5	8ms
1	1	0	Filter Time 6	16ms
1	1	1	Filter Time 7	32ms

**The following information applies when operating this equipment in hazardous locations:**

Products marked "CL I, DIV 2, GP A, B, C, D" are suitable for use in Class I Division 2 Groups A, B, C, and D Hazardous Locations and nonhazardous locations only. Each product is supplied with markings on the rating nameplate indicating the hazardous location temperature code. When combining products within a system, the most adverse temperature code (lowest "T" number) may be used to help determine the overall temperature code of the system. Combinations of equipment in your system are subject to investigation by the local Authority Having Jurisdiction at the time of installation.

<p><b>WARNING</b></p> 	<p><b>EXPLOSION HAZARD -</b></p> <ul style="list-style-type: none"><li>• Do not disconnect equipment unless power has been removed or the area is known to be nonhazardous.</li><li>• Do not disconnect connections to this equipment unless power has been removed or the area is known to be nonhazardous. Secure any external connections that mate to this equipment by using screws, sliding latches, threaded connectors, or other means provided with this product.</li><li>• Substitution of components may impair suitability for Class I, Division 2.</li><li>• If this product contains batteries, they must only be changed in an area known to be nonhazardous.</li></ul>
---	--

**Informations sur l'utilisation de cet équipement en environnements dangereux:**

Les produits marqués CL I, DIV 2, GP A, B, C, D ne conviennent que une utilisation en environnements de Classe I Division 2 Groupes A, B, C, D dangereux et non dangereux. Chaque produit est livré avec des marquages sur sa plaque d'identification qui indiquent le code de température pour les environnements dangereux. Lorsque plusieurs produits sont combinés dans un système, le code de température le plus défavorable (code de température le plus faible) peut être utilisé pour déterminer le code de température global du système. Les combinaisons d'équipements dans le système sont sujettes à inspection par les autorités locales qualifiées au moment de l'installation.

<p><b>AVERTISSEMENT</b></p> 	<p><b>RISQUE D'EXPLOSION -</b></p> <ul style="list-style-type: none"><li>• Couper le courant ou s'assurer que l'environnement est classé non dangereux avant de débrancher l'équipement.</li><li>• Couper le courant ou s'assurer que l'environnement est classé non dangereux avant de débrancher les connecteurs. Fixer tous les connecteurs externes reliés à cet équipement à l'aide de vis, loquets coulissants, connecteurs filetés ou autres moyens fournis avec ce produit.</li><li>• La substitution de composants peut rendre cet équipement inadapté à une utilisation en environnement de Classe 1, Division 2.</li><li>• S'assurer que l'environnement est classé non dangereux avant de changer les piles.</li></ul>
---	--

**Specifications – 24V dc Input Module Cat. No. 1794-IB16**

Number of Inputs	16 (1 group of 16), non-isolated, sinking
Module Location	Cat. No. 1794-TB3, -TB3S Terminal Base
ON-state Voltage	10V dc minimum; 24V dc nominal; 31.2V dc maximum
Mounting	Refer to Derating Curve
ON-state Current	2.0mA minimum; 8.0mA nominal at 24V dc; 12.0mA maximum
OFF-state Voltage	5.0V dc maximum
OFF-state Current	1.5mA minimum
Input Impedance	4.6K ohms maximum
Isolation Voltage	100% tested at 850V dc for 1s between user and system No isolation between individual channels
Input FilterTime	
Off to On	256μs, 512μs, 1ms, 2ms, 4ms, 8ms, 16ms, 32ms,
On to Off	256μs, 512μs, 1ms, 2ms, 4ms, 8ms, 16ms, 32ms, 256μs default – Selectable thru output image table,
Flexbus Current (maximum)	30mA
Power Dissipation	Maximum 6.1W @ 31.2V dc
Thermal Dissipation	Maximum 20.8 BTU/hr @ 31.2V dc
Indicators (field side indication, customer device driven)	16 yellow status indicators
Keyswitch Position	2

**General Specifications**

External dc Power Supply Voltage Voltage Range	24V dc nominal 10.0 to 31.2V dc (includes 5% ac ripple) See derating curve.
Dimensions	
Inches	1.8H x 3.7W x 2.1D
(Millimeters)	(45.7 x 94.0 x 53.3)
Environmental Conditions	
Operating Temperature	IEC 60068-2-1 (Test Ad, Operating Cold) IEC 60068-2-2 (Test Bd, Operating Dry Heat) IEC 60068-2-14 (Test Nb, Operating Thermal Shock) 32 to 131°F (0 to 55°C)

Specifications continued on next page.

**Specifications – 24V dc Input Module Cat. No. 1794-IB16**

Storage Temperature	IEC 60068-2-1 (Test Ab, Unpackaged, Nonoperating Cold) IEC 60068-2-2 (Test Bb, Unpackaged, Nonoperating Dry Heat) IEC 60068-2-14 (Test Na, Unpackaged, Nonoperating Thermal Shock) -40 to 185°F (-40 to 85°C)
Relative Humidity	IEC 60068-2-30 (Test Db, Unpackaged, Nonoperating Damp Heat) 5 to 95%, noncondensing
Shock Operating Nonoperating	IEC 60068-2-27 (Test Ea, Unpackaged Shock) 30g 50g
Vibration	IEC 60068-2-6 (Test Fc, Operating) 5g @ 10-500Hz
ESD Immunity	IEC 61000-4-2 4kV contact discharges 8kV air discharges
Radiated RF Immunity	IEC 61000-4-3 10V/m with 1kHz sine-wave 80% AM from 30MHz to 1000MHz
EFT/B Immunity	IEC 61000-4-4 ±2kV @ 5kHz on signal ports
Surge Transient Immunity	IEC 61000-4-5 ±1kV line-line (DM) and ±2kV line-earth (CM) on signal ports
Conducted RF Immunity	IEC 61000-4-6 10V rms with 1kHz sine wave 80% AM from 150kHz to 80MHz
Emissions	CISPR 11: Group 1, Class A (with appropriate enclosure)
Enclosure Type Rating	None (open-style)
Conductors Wire Size	12 gauge (4mm <sup>2</sup> ) stranded copper wire maximum rated at 75°C or greater
Category	3/64 inch (1.2mm) insulation maximum 2 <sup>1</sup>

**Specifications continued on next page.**

**Specifications – 24V dc Input Module Cat. No. 1794-IB16**

Agency Certification (when product is marked)	UL	UL Listed Industrial Control Equipment
	UL	UL Listed for Class I, Division 2 Group A, B, C and D Hazardous Locations
	CSA	CSA Certified Process Control Equipment for Class I, Division 2 Group A, B, C, D Hazardous Locations
	EEx <sup>2</sup>	European Union 94/9/EEC EMC Directive, compliant with: EN 50021; Potentially Explosive Atmospheres, Protection "n"
	CE <sup>2</sup>	European Union 89/336/EEC EMC Directive, compliant with: EN 50081-2, Industrial Emissions EN 50082-2, Industrial Immunity EN 61326, Meas./Control/Lab., Industrial Requirements EN 61000-6-2, Industrial Immunity
	C-Tick <sup>2</sup>	Australian Radiocommunications Act, compliant with: AS/NZS 2064, Industrial Emissions

<sup>1</sup> You use this conductor category information for planning conductor routing as described in the system level installation manual.

<sup>2</sup> See the Product Certification link at [www.ab.com](http://www.ab.com) for Declarations of Conformity, Certificates and other certification details

**European Zone 2 Certification**

This equipment is intended for use in potentially explosive atmospheres as defined by European Union Directive 94/9/CE.

The LCIE (Laboratoire Central des Industries Electriques) certifies that this equipment has been found to comply with the Essential Health and Safety Requirements relating to the design and construction of Category 3 equipment intended for use in potentially explosive atmospheres, given in Annex II to this Directive. The examination and test results are recorded in confidential report No. 28 682 101.

Compliance with the Essential Health and Safety Requirements has been assured by compliance with EN 50021 (1999).

**IMPORTANT**



Observe the following additional Zone 2 certification requirements:

- This equipment is not resistant to sunlight or other sources of UV radiation.
  - The secondary of a current transformer shall not be open-circuited.
  - The marking "ALCR" is to be considered "as applicable" to individual products.
  - Equipment of lesser Enclosure Type Rating must be installed in an enclosure providing at least IP54 protection when applied in Class I, Zone 2 environments.
  - This equipment must be powered by energy limited associated equipment as defined in EN 50021 when applied in Class I, Zone 2 environments.
  - Provision shall be made to prevent the rated voltage from being exceeded by transient disturbances of more than 40% when applied in Class I, Zone 2 environments.
-

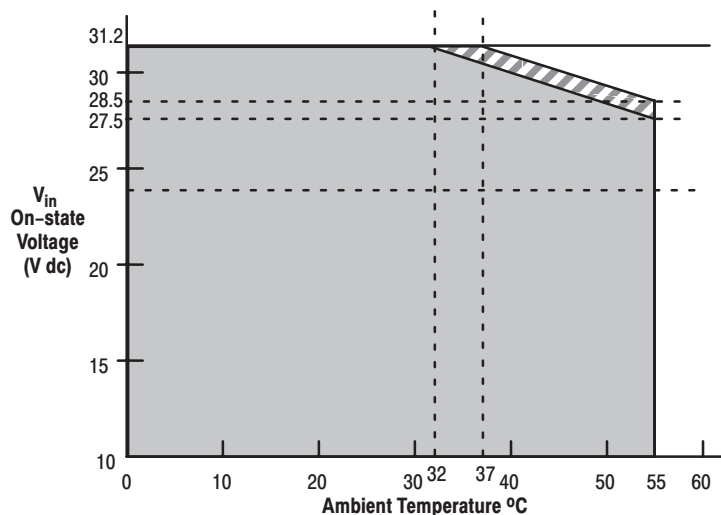
**Derating Curve**



The area within the curve represents the safe operating range for the module under various conditions of user supplied 24V dc supply voltages and ambient temperatures.

-  = Normal mounting safe operating range, (includes  ).
-  = Other mounting positions (including inverted horizontal) safe operating range

Normal Mounting - Horizontal

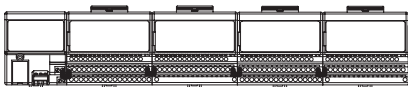

Other Mounting (including Vertical, and Inverted Horizontal Mounting)

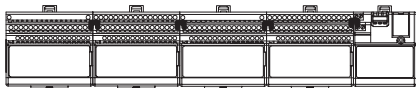

Voltage (max.)	Temperature (max.)		Voltage (max.)	Temperature (max.)	
	Normal	Other		Normal	Other
31.2	37	32	29.0	51	45
30.5	41	36	28.5	55	48
30.0	45	39	28.0		51
29.5	48	42	27.5		55



With major offices worldwide. 

---

World Headquarters,  
Allen-Bradley,  
1201 South Second Street,  
Milwaukee, WI 53204 USA,  
Tel: (1) 414 382-2000 Fax: (1) 414 382-4444