



FLEX I/O AC Digital Input Modules

Catalog numbers 1794-IA8, 1794-IA8I, 1794-IA16

Table of Contents

Topic	Page
Important User Information	2
Environment and Enclosure	3
Preventing Electrostatic Discharge	3
North American Hazardous Location Approval	4
Installing Your AC Digital Input Module	6
Configuring Your AC Input Module	14
Specifications	16

Important User Information

Solid-state equipment has operational characteristics differing from those of electromechanical equipment. Safety Guidelines for the Application, Installation, and Maintenance of Solid-State Controls (Publication SGI-1.1 available from your local Rockwell Automation Sales Office or online at <http://www.rockwellautomation.com/literature/>) describes some important differences between solid-state equipment and hard-wired electromechanical devices. Because of this difference, and also because of the wide variety of uses for solid-state equipment, all persons responsible for applying this equipment must satisfy themselves that each intended application of this equipment is acceptable.





In no event will Rockwell Automation, Inc. be responsible or liable for indirect or consequential damages resulting from the use or application of this equipment.

The examples and diagrams in this manual are included solely for illustrative purposes. Because of the many variables and requirements associated with any particular installation, Rockwell Automation, Inc. cannot assume responsibility or liability for actual use based on the examples and diagrams.

No patent liability is assumed by Rockwell Automation, Inc. with respect to use of information, circuits, equipment, or software described in this manual.

Reproduction of the contents of this manual, in whole or in part, without written permission of Rockwell Automation, Inc., is prohibited.

Throughout this manual, when necessary, we use notes to make you aware of safety considerations.

	WARNING: Identifies information about practices or circumstances that can cause an explosion in a hazardous environment, which may lead to personal injury or death, property damage, or economic loss.
	ATTENTION: Identifies information about practices or circumstances that can lead to personal injury or death, property damage, or economic loss. Attentions help you identify a hazard, avoid a hazard, and recognize the consequences.
	SHOCK HAZARD: Labels may be on or inside the equipment (for example, drive or motor) to alert people that dangerous voltage may be present.
	BURN HAZARD: Labels may be on or inside the equipment (for example, drive or motor) to alert people that surfaces may reach dangerous temperatures.
IMPORTANT	Identifies information that is critical for successful application and understanding of the product.

Environment and Enclosure



ATTENTION: This equipment is intended for use in a Pollution Degree 2 industrial environment, in overvoltage Category II applications (as defined in IEC publication 60664-1), at altitudes up to 2000 m (6562 ft) without derating.

This equipment is considered Group 1, Class A industrial equipment according to IEC/CISPR Publication 11. Without appropriate precautions, there may be potential difficulties ensuring electromagnetic compatibility in other environments due to conducted as well as radiated disturbance.

This equipment is supplied as open-type equipment. It must be mounted within an enclosure that is suitably designed for those specific environmental conditions that will be present and appropriately designed to prevent personal injury resulting from accessibility to live parts. The interior of the enclosure must be accessible only by the use of a tool. Subsequent sections of this publication may contain additional information regarding specific enclosure type ratings that are required to comply with certain product safety certifications.

In addition to this publication, see:

- Industrial Automation Wiring and Grounding Guidelines, Rockwell Automation publication [1770-4.1](#), for additional installation requirements.
- NEMA Standard 250 and IEC 60529, as applicable, for explanations of the degrees of protection provided by different types of enclosure.

Preventing Electrostatic Discharge





ATTENTION: This equipment is sensitive to electrostatic discharge, which can cause internal damage and affect normal operation. Follow these guidelines when you handle this equipment:

- Touch a grounded object to discharge potential static.
 - Wear an approved grounding wriststrap.
 - Do not touch connectors or pins on component boards.
 - Do not touch circuit components inside the equipment.
 - Use a static-safe workstation, if available.
-

4 FLEX I/O AC Digital Input Modules

North American Hazardous Location Approval

The following modules are North American Hazardous Location approved: 1794-IA8, 1794-IA8I, 1794-IA16.

The following information applies when operating this equipment in hazardous locations:	Informations sur l'utilisation de cet équipement en environnements dangereux:
<p>Products marked "CL I, DIV 2, GP A, B, C, D" are suitable for use in Class I Division 2 Groups A, B, C, D, Hazardous Locations and nonhazardous locations only. Each product is supplied with markings on the rating nameplate indicating the hazardous location temperature code. When combining products within a system, the most adverse temperature code (lowest "T" number) may be used to help determine the overall temperature code of the system. Combinations of equipment in your system are subject to investigation by the local Authority Having Jurisdiction at the time of installation.</p>	<p>Les produits marqués "CL I, DIV 2, GP A, B, C, D" ne conviennent qu'à une utilisation en environnements de Classe I Division 2 Groupes A, B, C, D dangereux et non dangereux. Chaque produit est livré avec des marquages sur sa plaque d'identification qui indiquent le code de température pour les environnements dangereux. Lorsque plusieurs produits sont combinés dans un système, le code de température le plus défavorable (code de température le plus faible) peut être utilisé pour déterminer le code de température global du système. Les combinaisons d'équipements dans le système sont sujettes à inspection par les autorités locales qualifiées au moment de l'installation.</p>
 <p>EXPLOSION HAZARD</p> <ul style="list-style-type: none">• Do not disconnect equipment unless power has been removed or the area is known to be nonhazardous.• Do not disconnect connections to this equipment unless power has been removed or the area is known to be nonhazardous. Secure any external connections that mate to this equipment by using screws, sliding latches, threaded connectors, or other means provided with this product.• Substitution of components may impair suitability for Class I, Division 2.• If this product contains batteries, they must only be changed in an area known to be nonhazardous.	 <p>RISQUE D'EXPLOSION</p> <ul style="list-style-type: none">• Couper le courant ou s'assurer que l'environnement est classé non dangereux avant de débrancher l'équipement.• Couper le courant ou s'assurer que l'environnement est classé non dangereux avant de débrancher les connecteurs. Fixer tous les connecteurs externes reliés à cet équipement à l'aide de vis, loquets coulissants, connecteurs filetés ou autres moyens fournis avec ce produit.• La substitution de composants peut rendre cet équipement inadapté à une utilisation en environnement de Classe I, Division 2.• S'assurer que l'environnement est classé non dangereux avant de changer les piles.



ATTENTION: FLEX™ I/O is grounded through the DIN rail to chassis ground. Use zinc plated yellow-chromate steel DIN rail to assure proper grounding. The use of other DIN rail materials (for example, aluminum or plastic) that can corrode, oxidize, or are poor conductors, can result in improper or intermittent grounding.



WARNING: If you insert or remove the module while backplane power is on, an electrical arc can occur. This could cause an explosion in hazardous location installations. Be sure that power is removed or the area is nonhazardous before proceeding.



WARNING: If you connect or disconnect wiring while the field-side power is on, an electrical arc can occur. This could cause an explosion in hazardous location installations. Be sure that power is removed or the area is nonhazardous before proceeding.

Installing Your AC Digital Input Module

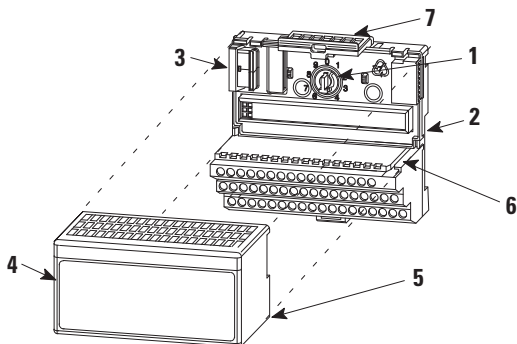

	Description		Description
1	Keyswitch	5	Alignment bar
2	Terminal base	6	Groove
3	Flexbus connector	7	Latching mechanism
4	Module		

The module mounts on a 1794 terminal base.



ATTENTION: During mounting of all devices, be sure that all debris (metal chips, wire strands, etc.) is kept from falling into the module. Debris that falls into the module could cause damage on power up.

1. Rotate the keyswitch (1) on the terminal base (2) clockwise to position 8 as required for this type of module.
2. Make certain the flexbus connector (3) is pushed all the way to the left to connect with the neighboring terminal base/adaptor. **You cannot install the module unless the connector is fully extended.**

3. Make sure the pins on the bottom of the module are straight so they will align properly with the connector in the terminal base.



WARNING: If you insert or remove the module while backplane power is on, an electrical arc can occur. This could cause an explosion in hazardous location installations. Be sure that power is removed or the area is nonhazardous before proceeding.

4. Position the module (4) with its alignment bar (5) aligned with the groove (6) on the terminal base.
5. Press firmly and evenly to seat the module in the terminal base unit. The module is seated when the latching mechanism (7) is locked into the module.

Connecting Wiring for the 1794-IA8

1. **For 1794-TB2, 1794-TB3, or 1794-TB3S** – Connect individual input wiring to even numbered terminals on the 0-15 row (A) as indicated in the Wiring Connections for 1794-IA8 table.

For 1794-TBN – Connect individual input wiring to numbered terminals on the 16-33 row (B) as indicated in the Wiring Connections for 1794-IA8 table.

2. **For 1794-TB2** – Connect the associated 120V AC power lead (L1) of the input device to the corresponding odd numbered terminals on the 0-15 row A for each input as indicated in the Wiring Connections for 1794-IA8 table. (The odd numbered terminals on row A are internally connected to 120V AC L1.)

For 1794-TB3 or 1794-TB3S – Connect the associated 120V AC power lead (L1) of the input device to the corresponding odd numbered terminals on the 34-51 row (C) or to the corresponding terminal on row (C) for each input as indicated in the Wiring Connections for 1794-IA8 table. (The odd numbered terminals on row (A) and the terminals of row (C) are internally connected to 120V AC power L1.)

8 FLEX I/O AC Digital Input Modules

For 1794-TBN – Connect the associated 120V AC power lead (L1) of the input device to the corresponding odd numbered terminal on the 34-51 row (C) for each input as indicated in the Wiring Connections for 1794-IA8 table. (The 120V AC power terminals of row (C) are internally connected together.)

3. Connect 120V AC power (L1) to terminal 34 on the 34-51 row (C).
4. Connect 120V AC common (L2) to terminal 16 on the 16-33 row (B).
5. If daisy chaining power to the next terminal base, connect a jumper from terminal 51 (+120V AC L1) on this base unit to terminal 34 on the next base unit.
6. If continuing AC common to the next base unit, connect a jumper from terminal 33 (120V common L2) on this base unit to terminal 16 on the next base unit.

Wiring Connections for 1794-IA8

Input	1794-TB2, 1794-TB3, 1794-TB3S		1794-TBN	
	Input Terminal	120V AC Supply	Input Terminal	120V AC Supply
Input 0	A-0	A-1 ⁽¹⁾ /C-35	B-0	C-1 ⁽²⁾
Input 1	A-2	A-3 ⁽¹⁾ /C-36	B-2	C-3 ⁽²⁾
Input 2	A-4	A-5 ⁽¹⁾ /C-37	B-4	C-5 ⁽²⁾
Input 3	A-6	A-7 ⁽¹⁾ /C-38	B-6	C-7 ⁽²⁾
Input 4	A-8	A-9 ⁽¹⁾ /C-39	B-8	C-9 ⁽²⁾
Input 5	A-10	A-11 ⁽¹⁾ /C-40	B-10	C-11 ⁽²⁾
Input 6	A-12	A-13 ⁽¹⁾ /C-41	B-12	C-13 ⁽²⁾
Input 7	A-14	A-15 ⁽¹⁾ /C-42	B-14	C-15 ⁽²⁾
A = Input terminals (Even numbered terminals 0...14) B = Common terminals C = Power terminals (C-34 and C-51 on 1794-TB2; C-34 to C-51 on 1794-TB3 and 1794-TB3S)			B = Even numbered input terminals 0...14, AC common terminals 16 and 33 C = Power terminals C-34 and C-51, and odd numbered input terminals 1...15	

⁽¹⁾ A-1, 3, 5, 7, 9, 11, 13, and 15 on the 1794-TB2, 1794-TB3, and 1794-TB3S are internally connected in the module to 120V AC L1.

⁽²⁾ C-1, 3, 5, 7, 9, 11, 13, and 15 on the 1794-TBN are internally connected in the module to 120V AC L1.

1794-TB2, 1794-TB3, and 1794-TB3S Terminal Base Wiring for 1794-IA8 and 1794-IA16

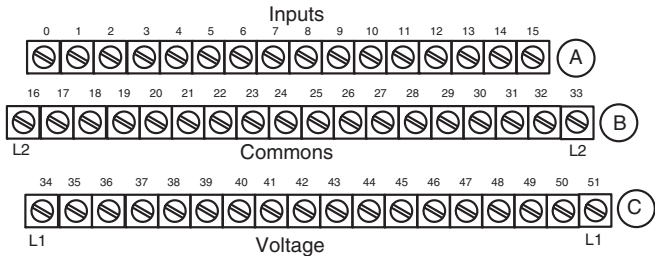

(1794-TB3 shown)

Connect 120V AC L1 power to terminal C-34

Connect 120V AC common L2 to terminal B-16

Use B-33 and C-51 for daisy chaining to the next terminal base unit
(Terminals C-35 thru C-50 not available on the 1794-TB2.)

1794-TBN Terminal Base Wiring for 1794-IA8 and 1794-IA16

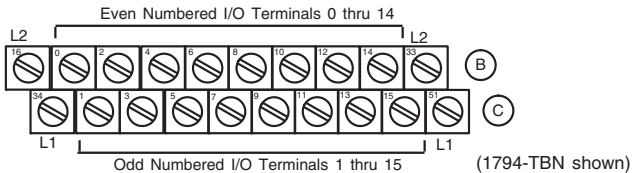

(1794-TBN shown)

L1 = 120V AC - Connect to terminal C-34

L2 = 120V AC common - Connect to terminal B-16

Use B-33 and C-51 for daisy chaining to the next terminal base unit

Connecting Wiring for the 1794-IA16

1. **For 1794-TB3 or 1794-TB3S** – Connect individual input wiring to numbered terminals on the 0-15 row (A) as indicated in the Terminal Base Wiring for 1794-IA16 table.

For 1794-TBN – Connect individual input wiring to even numbered terminals on the 16-33 row (B), and to the odd numbered terminals on the 34-51 row (C) as indicated in the Terminal Base Wiring for 1794-IA16 table.

10 FLEX I/O AC Digital Input Modules

2. **For 1794-TB3 or 1794-TB3S** – Connect the associated 120V AC power lead (L1) of the input device to the corresponding terminals on the 34-51 row (C) for each input as indicated in the Terminal Base Wiring for 1794-IA16 table. (The 120V power terminals of row (C) are internally connected together.)

For 1794-TBN – An external terminal strip is needed to distribute 120V AC power (L1) to each device.

3. Connect 120V AC power (L1) to terminal 34 on the 34-51 row (C).
4. Connect 120V AC common (L2) to terminal 16 on the 16-33 row (B).
5. If daisy chaining power to the next terminal base, connect a jumper from terminal 51 (+120V AC L1) on this base unit to terminal 34 on the next base unit.
6. If continuing AC common to the next base unit, connect a jumper from terminal 33 (120V common L2) on this base unit to terminal 16 on the next base unit.

Terminal Base Wiring for 1794-IA16

Input	Input Terminal 1794-TB3, 1794-TB3S	Input Terminal 1794-TBN	120V AC Supply (L1) ⁽¹⁾
Input 0	A-0	B-0	C-35
Input 1	A-1	C-1	C-36
Input 2	A-2	B-2	C-37
Input 3	A-3	C-3	C-38
Input 4	A-4	B-4	C-39
Input 5	A-5	C-5	C-40
Input 6	A-6	B-6	C-41
Input 7	A-7	C-7	C-42
Input 8	A-8	B-8	C-43
Input 9	A-9	C-9	C-44
Input 10	A-10	B-10	C-45
Input 11	A-11	C-11	C-46
Input 12	A-12	B-12	C-47
Input 13	A-13	C-13	C-48
Input 14	A-14	B-14	C-49

Terminal Base Wiring for 1794-IA16

Input	Input Terminal 1794-TB3, 1794-TB3S	Input Terminal 1794-TBN	120V AC Supply (L1) ⁽¹⁾
Input 15	A-15	C-15	C-50
120V AC L1	Power terminals C-34 to C-51 (C-34 and C-51 on 1794-TBN) are internally connected together. Connect 120V AC L1 to C-34.		
120V AC L2	Common terminals B-16 to B-33 (B-16 and B-33 for 1794-TBN) are internally connected together. Connect 120V AC common L2 to terminal B-16.		

⁽¹⁾ When using the 1794-TBN, an external terminal strip is needed to connect the 120V AC power connections.

Connecting Wiring for the 1794-IA8I

1. **For 1794-TB2, 1794-TB3, or 1794-TB3S** – Connect individual input wiring to even numbered terminals on the 0-15 row (A) as indicated in the Wiring Connections for 1794-IA8I table.

For 1794-TBN – Connect individual input wiring to even numbered terminals 0-14 on the 16-33 row (B) as indicated in the Wiring Connections for 1794-IA8I table.

2. **For 1794-TB2, 1794-TB3, or 1794-TB3S** – Connect the associated 120V AC common (L2) of the isolated supply to the corresponding odd numbered terminals on the 0-15 row A for each input as indicated in the Wiring Connections for 1794-IA8I table.

For 1794-TBN – Connect the associated 120V AC common lead (L2) of the isolated supply to the corresponding odd numbered terminal 1-15 on the 34-51 row (C) as indicated in the Wiring Connections for 1794-IA8I table.

IMPORTANT Individual isolated 120V AC L1 power leads must be run externally to each of the input devices.

Wiring Connections for 1794-IA8I

Input	1794-TB2, 1794-TB3, 1794-TB3S		1794-TBN	
	Input Terminal	120V AC L2 Common	Input Terminal	120V AC L2 Common
Input 0	A-0	A-1	B-0	C-1
Input 1	A-2	A-3	B-2	C-3
Input 2	A-4	A-5	B-4	C-5
Input 3	A-6	A-7	B-6	C-7
Input 4	A-8	A-9	B-8	C-9
Input 5	A-10	A-11	B-10	C-11
Input 6	A-12	A-13	B-12	C-13
Input 7	A-14	A-15	B-14	C-15
A = Even numbered terminals 0...14 for customer connections; corresponding odd numbered 120V AC common L2 terminals 1...15 for customer connections from isolated power supply.			B = Even numbered terminals 0...14 for customer connections; C = Odd numbered 120V AC common L2 terminals 1...15 for customer connections from isolated power supply.	

1794-TB2, 1794-TB3, and 1794-TB3S Terminal Base Wiring for 1794-IA8I

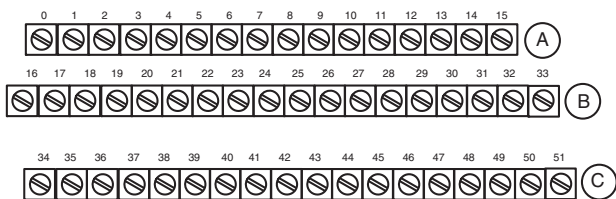

Connect Inputs to even numbered terminals on row (A) (1794-TB3 shown)

Connect 120V AC common L2 to odd numbered terminals on row (A)

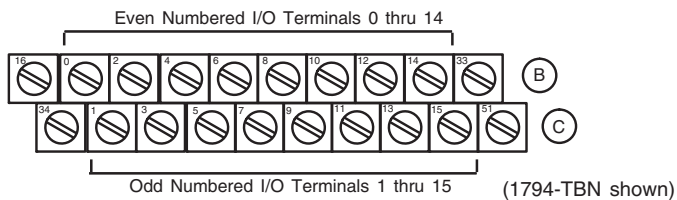
1794-TBN Terminal Base Wiring for 1794-IA8I

Connect Inputs to even numbered terminals on row (B)

L2 = 120V AC common - Connect to odd numbered terminals on row (C)

Configuring Your AC Input Module

Image Table Memory Map for the 1794-IA8 and 1794-IA8I Modules

Dec	15	14	13	12	11	10	9	8	7	6	5	4	3	2	1	0
Oct	17	16	15	14	13	12	11	10	7	6	5	4	3	2	1	0
Read									I7	I6	I5	I4	I3	I2	I1	I0
Write	Not used – set to 0												Filter Time FT 0...7			
Where	I = Input FT = Input filter time															

Image Table Memory Map for the 1794-IA16 Module

Dec	15	14	13	12	11	10	9	8	7	6	5	4	3	2	1	0
Oct	17	16	15	14	13	12	11	10	7	6	5	4	3	2	1	0
Read 1	I15	I14	I13	I12	I11	I10	I9	I8	I7	I6	I5	I4	I3	I2	I1	I0
Write 3	Not used – set to 0										Input Filter FT 12...15			Input Filter FT 0...11		
Where	I = Input FT = Input filter time															

Setting the Input Filter Time

You can increase the input filter time (FT) for channels 00-07 (1794-IA8 and 1794-IA8I) and channels 00-15 (1794-IA16) by setting the corresponding bits in the output image table (complementary word) for the module.

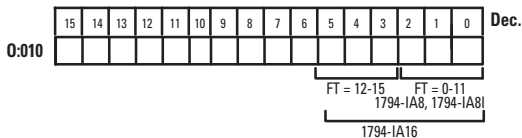

For example, to increase the off-to-on filter time to 12 ms for all inputs at address rack 1, module group 0, set bits and program as shown below.

Write filter time on system startup.

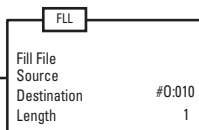

Write FT to complement of input module.

	7	6	5	4	3	2	1	0	
1794-IA8						1	0	0	= 4 Octal or 4 Decimal
1794-IA8I									

	7	6	5	4	3	2	1	0	
1794-IA16			1	0	0	1	0	0	= 44 Octal or 36 Decimal

To increase the filter time, set the bits according to the Input Filter Time table.

Input Filter Time

Bits			Description	Selected Filter Time	Maximum Filter Time (ms) 1794-IA8		Maximum Filter Time (ms) 1794-IA8I		Maximum Filter Time (ms) 1794-IA16	
02	01	00			Off to On	On to Off	Off to On	On to Off	Off to On	On to Off
02	01	00	Filter Time – inputs 00...11							
05	04	03	Filter Time – inputs 12...15							
0	0	0	Filter Time 0 (Default)	256 μ s	8.4	26.4	8.4	26.4	7.5	26.5
0	0	1	Filter Time 1	512 μ s	8.6	26.6	8.6	26.6	8	27
0	1	0	Filter Time 2	1 ms	9	27	9	27	9	28
0	1	1	Filter Time 3	2 ms	10	28	10	28	10	29
1	0	1	Filter Time 4	4 ms	12	30	12	30	12	31
1	0	1	Filter Time 5	8 ms	16	34	16	34	16	35
1	1	0	Filter Time 6	16 ms	24	42	24	42	24.5	44
1	1	1	Filter Time 7	32 ms	40	58	40	58	42	60.5

Specifications

Specifications – 1794-IA8, 1794-IA8I

Attribute	1794-IA8	1794-IA8I
Number of inputs	8, nonisolated	8, isolated
Recommended terminal base unit	1794-TBN, 1794-TB2, 1794-TB3, 1794-TB3S, 1794-TBKD, 1794-TB3K, 1794-TB3SK, 1794-TBNK	
On-state voltage, min	65V AC	
On-state voltage, nom	120V AC	
On-state voltage, max	132V AC	
On-state current, min ⁽¹⁾	7.1 mA	
On-state current, max	14.32 mA	
Off-state voltage, max	43V AC	
Off-state current, min	2.9 mA	
Nominal input impedance	10.6 k Ω	
Nominal input current	12 mA @ 120V AC	
Isolation voltage	120V (continuous), Basic Insulation Type Type tested @ 1250V AC for 60 s, between field side and system No isolation between individual channels	120V (continuous), Basic Insulation Type Type tested @ 1240V AC for 60 s, between field side and system Isolation between individual channels.
Input filter time	Refer to Input Filter Time table	
FlexBus current	30 mA @ 5V DC	
Power dissipation, max	4.5 W @ 132V AC	
Thermal dissipation, max	15.3 BTU/hr @ 132V AC	

⁽¹⁾ AC inputs compatible with proximity switches with leakage ratings of $I_{leak} < 2.5$ mA and I_{on} minimum = 5 mA

Specifications – 1794-IA16

Attribute	Value
Number of inputs	16, nonisolated
Module location	1794-TB3, 1794-TB3S, 1794-TBN ⁽²⁾ , 1794-TB3K, 1794-TB3SK, 1794-TBNK
On-state voltage, min	74V AC

Specifications – 1794-IA16

Attribute	Value
On-state voltage, nom	120V AC
On-state voltage, max	132V AC
On-state current, min ⁽¹⁾	5.49 mA
On-state current, max	14.81 mA
Off-state voltage, max	20V AC
Off-state current, min	2.9 mA
Nominal input impedance	10 k Ω
Nominal input current	12 mA @ 120V AC
Isolation voltage	120V (continuous), Basic Insulation Type Type tested @ 1264V AC for 60 s, between field side and system No isolation between individual channels
Input filter time	Refer to Input Filter Time table
FlexBus current	20 mA
Power dissipation, max	6.4 W @ 132V AC
Thermal dissipation, max	21.8 BTU/hr @ 132V AC

⁽¹⁾ AC inputs compatible with proximity switches with leakage ratings of $I_{leak} < 2.5$ mA and I_{on} minimum = 5 mA

⁽²⁾ Auxiliary terminal strips are required when using the 1794-TBN.

General Specifications

Attribute	Value
Terminal base screw torque	Determined by installed terminal base
Dimensions, approx. (H x W x D)	94 x 94 x 69 mm (3.7 x 3.7 x 2.7 in.)
Indicators (field side indication)	8 yellow status indicators – 1794-IA8, 1794-IA8I 16 yellow status indicators – 1794-IA16
External AC power supply voltage, nom	120V AC
External AC power voltage range	65...132V AC – 1794-IA8, 1794-IA8I 74...132V AC – 1794-IA16
North American temperature code	T4A
Keyswitch position	8

General Specifications

Attribute	Value
Enclosure type rating	None (open-style)
Wire size	Determined by installed terminal base
Wiring category ⁽¹⁾	2 – on signal ports

⁽¹⁾ Use this conductor category information for planning conductor routing as described in Industrial Automation Wiring and Grounding Guidelines, publication [1770-4.1](#).

Environmental Specifications

Attribute	Value
Operating temperature	IEC 60068-2-1 (Test Ad, Operating Cold), IEC 60068-2-2 (Test Bd, Operating Dry Heat), IEC 60068-2-14 (Test Nb, Operating Thermal Shock): -20...55 °C (-4...131 °F) – 1794-IA8, 1794-IA8I 0...55 °C (32...131 °F) – 1794-IA16
Storage temperature	IEC 60068-2-1 (Test Ab, Unpackaged Non-operating Cold), IEC 60068-2-2 (Test Bb, Unpackaged Non-operating Dry Heat), IEC 60068-2-14 (Test Na, Unpackaged Non-operating Thermal Shock): -40...85 °C (-40...185 °F)
Relative humidity	IEC 60068-2-30 (Test Db, Unpackaged Damp Heat): 5...95% non-condensing
Vibration	IEC60068-2-6 (Test Fc, Operating): 5 g @ 10...500 Hz
Shock, operating	IEC60068-2-27 (Test Ea, Unpackaged shock): 30 g
Shock, nonoperating	IEC60068-2-27 (Test Ea, Unpackaged shock): 50 g
Emissions	CISPR 11: Group 1, Class A (with appropriate enclosure)
ESD immunity	IEC 61000-4-2: 6 kV contact discharges 8 kV air discharges
Radiated RF immunity	IEC 61000-4-3: 10V/m with 1 kHz sine-wave 80% AM from 80...2000 MHz 10V/m with 200 Hz 50% Pulse 100% AM @ 900 MHz 10V/m with 200 Hz 50% Pulse 100% AM @ 1890 MHz 1V/m with 1 kHz sine-wave 80% AM from 2000...2700 MHz – 1794-IA8, 1794-IA8I 1V/m with 1 kHz sine-wave 80% AM from 2000...2700 MHz – 1794-IA16

Environmental Specifications

Attribute	Value
EFT/B immunity	IEC 61000-4-4: ±2 kV @ 5 kHz on power ports ±2 kV @ 5 kHz on signal ports
Surge transient immunity	IEC 61000-4-5: ±1 kV line-line(DM) and ±2 kV line-earth(CM) on signal ports
Conducted RF immunity	IEC 61000-4-6: 10V rms with 1 kHz sine-wave 80% AM from 150 kHz...80 MHz

Certifications

Certifications (when product is marked) ⁽¹⁾	Value
UL	UL Listed Industrial Control Equipment. See UL File E65584.
CSA	CSA Certified Process Control Equipment. See CSA File LR54689C. – 1794-IA8, 1794-IA8I See CSA File LR93701. – 1794-IA16 CSA Certified Process Control Equipment for Class I, Division 2 Group A,B,C,D Hazardous Locations. See CSA File LR69960C. – 1794-IA8, 1794-IA8I See CSA File LR93701. – 1794-IA16
CE	European Union 2004/108/EC EMC Directive, compliant with: EN 61326-1; Meas./Control/Lab., Industrial Requirements EN 61000-6-2; Industrial Immunity EN 61000-6-4; Industrial Emissions EN 61131-2; Programmable Controllers (Clause 8, Zone A & B) European Union 2006/95/EC LVD, compliant with: EN 61131-2; Programmable Controllers (Clause 11)
KC	Korean Registration of Broadcasting and Communications Equipment, compliant with: Article 58-2 of Radio Waves Act, Clause 3
EAC	Russian Customs Union TR CU 020/2011 EMC Technical Regulation
RCM	Australian Radiocommunications Act, compliant with: AS/NZS CISPR 11; Industrial Emissions

⁽¹⁾ See the Product Certification link at www.ab.com for Declarations of Conformity, Certificates, and other certification details.

Rockwell Automation Support

Rockwell Automation provides technical information on the Web to assist you in using its products. At <http://www.rockwellautomation.com/support/>, you can find technical manuals, a knowledge base of FAQs, technical and application notes, sample code and links to software service packs, and a MySupport feature that you can customize to make the best use of these tools.

For an additional level of technical phone support for installation, configuration and troubleshooting, we offer TechConnect support programs. For more information, contact your local distributor or Rockwell Automation representative, or visit <http://www.rockwellautomation.com/support/>.

Installation Assistance

If you experience a problem within the first 24 hours of installation, please review the information that's contained in this manual. You can also contact a special Customer Support number for initial help in getting your product up and running.

United States or Canada	1.440.646.3434
Outside United States or Canada	Use the Worldwide Locator at http://www.rockwellautomation.com/support/americas/phone_en.html , or contact your local Rockwell Automation representative.

New Product Satisfaction Return

Rockwell Automation tests all of its products to ensure that they are fully operational when shipped from the manufacturing facility. However, if your product is not functioning and needs to be returned, follow these procedures.

United States	Contact your distributor. You must provide a Customer Support case number (call the phone number above to obtain one) to your distributor to complete the return process.
Outside United States	Please contact your local Rockwell Automation representative for the return procedure.

Documentation Feedback

Your comments will help us serve your documentation needs better. If you have any suggestions on how to improve this document, complete this form, publication [RA-DU002](#), available at <http://www.rockwellautomation.com/literature/>.

Allen-Bradley, Rockwell Automation, FLEX I/O, and TechConnect are trademarks of Rockwell Automation, Inc.

Trademarks not belonging to Rockwell Automation are property of their respective companies.

Rockwell Otomasyon Ticaret A.Ş., Kar Plaza İş Merkezi E Blok Kat:6 34752 İçerenköy, İstanbul, Tel: +90 (216) 5698400

www.rockwellautomation.com

Power, Control and Information Solutions Headquarters

Americas: Rockwell Automation, 1201 South Second Street, Milwaukee, WI 53204-2496 USA, Tel: (1) 414.382.2000, Fax: (1) 414.382.4444
Europe/Middle East/Africa: Rockwell Automation, Voorlaan/Boulevard du Souverain 36, 1170 Brussels, Belgium, Tel: (32) 2 663 0600, Fax: (32) 2 663 0640
Asia Pacific: Rockwell Automation, Level 14, Core F, Cyberport 3, 100 Cyberport Road, Hong Kong, Tel: (852) 2887 4788, Fax: (852) 2508 1846

Publication 1794-IN102C-EN-P - July 2015

Supersedes Publication 1794-IN102B-EN-P - June 2004

Copyright © 2015 Rockwell Automation, Inc. All rights reserved.