

Installation Instructions

FLEX I/O Isolated Output HART Analog Module

Catalog Number 1794-OF8IH

Topic	Page
Important User Information	2
Environment and Enclosure	3
Preventing Electrostatic Discharge	4
North American Hazardous Location Approval	5
Install the Module	7
Wire the Module	8
Ground the Module	10
Module Wiring	11
Cyclic HART Input Data	19
Status Indicator	23
Specifications	23

AB Part

Important User Information

Solid state equipment has operational characteristics differing from those of electromechanical equipment. Safety Guidelines for the Application, Installation and Maintenance of Solid State Controls (Publication [SGI-1.1](#) available from your local Rockwell Automation sales office or online at <http://literature.rockwellautomation.com>) describes some important differences between solid state equipment and hard-wired electromechanical devices. Because of this difference, and also because of the wide variety of uses for solid state equipment, all persons responsible for applying this equipment must satisfy themselves that each intended application of this equipment is acceptable.





In no event will Rockwell Automation, Inc. be responsible or liable for indirect or consequential damages resulting from the use or application of this equipment.

The examples and diagrams in this manual are included solely for illustrative purposes. Because of the many variables and requirements associated with any particular installation, Rockwell Automation, Inc. cannot assume responsibility or liability for actual use based on the examples and diagrams.

No patent liability is assumed by Rockwell Automation, Inc. with respect to use of information, circuits, equipment, or software described in this manual.

Reproduction of the contents of this manual, in whole or in part, without written permission of Rockwell Automation, Inc., is prohibited.

Throughout this manual, when necessary, we use notes to make you aware of safety considerations.

WARNING 	Identifies information about practices or circumstances that can cause an explosion in a hazardous environment, which may lead to personal injury or death, property damage, or economic loss.
IMPORTANT	Identifies information that is critical for successful application and understanding of the product.
ATTENTION 	Identifies information about practices or circumstances that can lead to personal injury or death, property damage, or economic loss. Attentions help you identify a hazard, avoid a hazard and recognize the consequences.
SHOCK HAZARD 	Labels may be on or inside the equipment (for example, drive or motor) to alert people that dangerous voltage may be present.
BURN HAZARD 	Labels may be on or inside the equipment (for example, drive or motor) to alert people that surfaces may reach dangerous temperatures.

Environment and Enclosure

ATTENTION

This equipment is intended for use in a Pollution Degree 2 industrial environment, in overvoltage Category II applications (as defined in IEC publication 60664-1), at altitudes up to 2000 meters (6562 ft) without derating.

This equipment is considered Group 1, Class A industrial equipment according to IEC/CISPR Publication 11. Without appropriate precautions, there may be potential difficulties ensuring electromagnetic compatibility in other environments due to conducted as well as radiated disturbance.

This equipment is supplied as open-type equipment. It must be mounted within an enclosure that is suitably designed for those specific environmental conditions that will be present and appropriately designed to prevent personal injury resulting from accessibility to live parts. The enclosure must have suitable flame-retardant properties to prevent or minimize the spread of flame, complying with a flame spread rating of 5VA, V2, V1, V0 (or equivalent) if non-metallic. The interior of the enclosure must be accessible only by the use of a tool. Subsequent sections of this publication may contain additional information regarding specific enclosure type ratings that are required to comply with certain product safety certifications.

In addition to this publication, see:

- Industrial Automation Wiring and Grounding Guidelines, for additional installation requirements, Allen-Bradley publication [1770-4.1](#).
- NEMA Standards publication 250 and IEC publication 60529, as applicable, for explanations of the degrees of protection provided by different types of enclosure.

WARNING

If you insert or remove the module while backplane power is on, an electrical arc can occur. This could cause an explosion in hazardous location installations. Be sure that power is removed or the area is nonhazardous before proceeding

WARNING

If you connect or disconnect wiring while the field-side power is on, an electrical arc can occur. This could cause an explosion in hazardous location installations. Be sure that power is removed or the area is nonhazardous before proceeding.

4 FLEX I/O Isolated Output HART Analog Module

ATTENTION



This product is grounded through the DIN rail to chassis ground. Use zinc plated yellow-chromate steel DIN rail to assure proper grounding. The use of other DIN rail materials (for example, aluminum and plastic) that can corrode, oxidize, or are poor conductors, can result in improper or intermittent grounding. Secure DIN rail to mounting surface approximately every 200 mm (7.8 in.) and use end anchors appropriately.

Preventing Electrostatic Discharge

ATTENTION



This equipment is sensitive to electrostatic discharge, which can cause internal damage and affect normal operation. Follow these guidelines when you handle this equipment:

- Touch a grounded object to discharge potential static.
 - Wear an approved grounding wriststrap.
 - Do not touch connectors or pins on component boards.
 - Do not touch circuit components inside the equipment.
 - Use a static-safe workstation, if available.
 - Store the equipment in appropriate static-safe packaging when not in use.
-

ATTENTION



To reduce susceptibility to noise, power analog modules and digital modules from separate power supplies.

ATTENTION





Do not exceed a length of 3 m (9.8 ft) for DC power cabling.

ATTENTION



To comply with the CE Low Voltage Directive (LVD), all connected I/O must be powered from a source compliant with the following:
Safety Extra Low Voltage (SELV) or Protected Extra Low Voltage (PELV).

North American Hazardous Location Approval

<p>The following information applies when operating this equipment in hazardous locations:</p>	<p>Informations sur l'utilisation de cet équipement en environnements dangereux:</p>
<p>Products marked "CL I, DIV 2, GP A, B, C, D" are suitable for use in Class I Division 2 Groups A, B, C, D, Hazardous Locations and nonhazardous locations only. Each product is supplied with markings on the rating nameplate indicating the hazardous location temperature code. When combining products within a system, the most adverse temperature code (lowest "T" number) may be used to help determine the overall temperature code of the system. Combinations of equipment in your system are subject to investigation by the local Authority Having Jurisdiction at the time of installation.</p>	<p>Les produits marqués "CL I, DIV 2, GP A, B, C, D" ne conviennent qu'à une utilisation en environnements de Classe I Division 2 Groupes A, B, C, D dangereux et non dangereux. Chaque produit est livré avec des marquages sur sa plaque d'identification qui indiquent le code de température pour les environnements dangereux. Lorsque plusieurs produits sont combinés dans un système, le code de température le plus défavorable (code de température le plus faible) peut être utilisé pour déterminer le code de température global du système. Les combinaisons d'équipements dans le système sont sujettes à inspection par les autorités locales qualifiées au moment de l'installation.</p>
<p>WARNING</p> 	<p>EXPLOSION HAZARD -</p> <ul style="list-style-type: none"> Do not disconnect equipment unless power has been removed or the area is known to be nonhazardous. Do not disconnect connections to this equipment unless power has been removed or the area is known to be nonhazardous. Secure any external connections that mate to this equipment by using screws, sliding latches, threaded connectors, or other means provided with this product. Substitution of components may impair suitability for Class I, Division 2. If this product contains batteries, they must only be changed in an area known to be nonhazardous.
<p>AVERTISSEMENT</p> 	<p>RISQUE D'EXPLOSION –</p> <ul style="list-style-type: none"> Couper le courant ou s'assurer que l'environnement est classé non dangereux avant de débrancher l'équipement. Couper le courant ou s'assurer que l'environnement est classé non dangereux avant de débrancher les connecteurs. Fixer tous les connecteurs externes reliés à cet équipement à l'aide de vis, loquets coulissants, connecteurs filetés ou autres moyens fournis avec ce produit. La substitution de composants peut rendre cet équipement inadapté à une utilisation en environnement de Classe 1, Division 2. S'assurer que l'environnement est classé non dangereux avant de changer les piles.

AB Par

European Hazardous Location Approval

European Zone 2 Certification (The following applies when the product bears the Ex or EEx Marking.)

This equipment is intended for use in potentially explosive atmospheres as defined by European Union Directive 94/9/EC and has been found to comply with the Essential Health and Safety Requirements relating to the design and construction of Category 3 equipment intended for use in potentially explosive atmospheres, given in Annex II to this Directive.

Compliance with the Essential Health and Safety Requirements has been assured by compliance with EN 60079-15 and EN 60079-0.

ATTENTION

This equipment is not resistant to sunlight or other sources of UV radiation.



WARNING



- This equipment must be installed in an enclosure providing at least IP54 protection when applied in Zone 2 environments.
 - This equipment shall be used within its specified ratings defined by Allen-Bradley.
 - Provision shall be made to prevent the rated voltage from being exceeded by transient disturbances of more than 40% when applied in Zone 2 environments.
 - This equipment must be used only with ATEX certified backplanes.
 - Secure any external connections that mate to this equipment by using screws, sliding latches, threaded connectors, or other means provided with this product.
 - Do not disconnect equipment unless power has been removed or the area is known to be nonhazardous.
-

Install the Module

Read this for information about how to install the module, which mounts on a 1794-TB3 or 1794-TB3S terminal base.

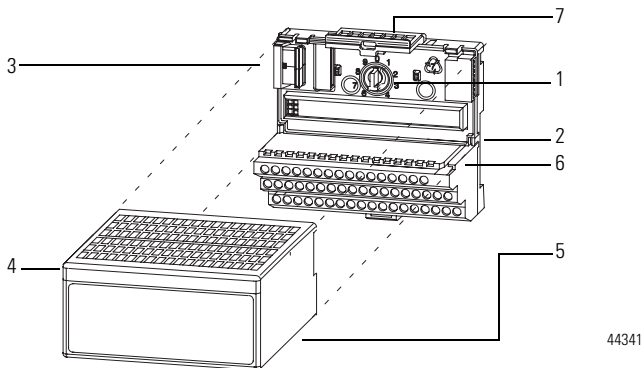

ATTENTION



During mounting of all devices, be sure that all debris (such as metal chips or wire strands) is kept from falling into the module. Debris that falls into the module could cause damage on power up.

To install the module on a 1794 terminal base, refer to the figure and complete the following.

1. Rotate the keyswitch (1) on the terminal base (2) clockwise to position 3 as required for this type of module.
2. Make sure the flexbus connector (3) is pushed all the way to the left to connect with the neighboring terminal base or adapter.

IMPORTANT

You cannot install the module unless the connector is fully extended.

AB Par

8 FLEX I/O Isolated Output HART Analog Module

3. Make sure the pins on the bottom of the module are straight so they align properly with the connector in the terminal base.

WARNING

If you remove or insert the module while the backplane power is on, an electrical arc can occur. This could cause an explosion in hazardous location installations. Be sure that power is removed or the area is nonhazardous before proceeding.

4. Position the module (4) with its alignment bar (5) aligned with the groove (6) on the terminal base.
5. Press firmly and evenly to seat the module in the terminal base unit, noting that the module is seated when the latching mechanism (7) is locked into the module.

Wire the Module

WARNING

If you connect or disconnect wiring while the field-side power is on, an electrical arc can occur. This could cause an explosion in hazardous location installations. Be sure that power is removed or the area is nonhazardous before proceeding.

To connect wiring for 1794-TB3 and 1794-TB3S bases, refer to the tables and figure and complete the following.

1. Connect individual output wiring to numbered terminals on the 0...15 row A, as indicated in the table, using Belden 8761 cable for signal wiring.

ATTENTION

Connect only one current signal per channel.

2. Connect each channel signal return to the associated terminal on row A.
3. Connect the +V DC power lead to terminal 34 on the 34...51 row C, and the -V common/return to terminal 16 on the 16...33 row B.

ATTENTION

To reduce susceptibility to noise, power analog modules and digital modules from separate power supplies.

Do not exceed a length of 3 m (9.8 ft) for DC power cabling.

4. If daisy-chaining power to the next terminal base, connect a jumper from terminal 51 (+V DC) on this base unit to terminal 34 on the next base unit.
5. If continuing DC common to the next base unit, connect a jumper from terminal 33 (common) on this base unit to terminal 16 on the next base unit,
6. For both 1794-TB3 and 1794-TB3S bases, connect wiring shields to functional earth ground as near as possible to the module.

AB Par

Ground the Module

All I/O wiring must use shielded wire. Shields must be terminated external to the module, such as bus bars and shield-terminating feed-throughs.

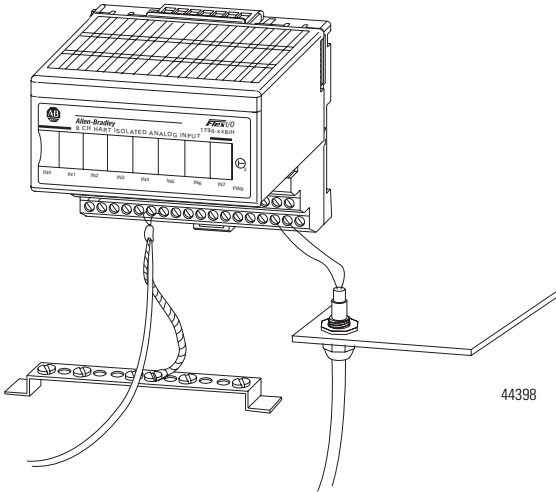

Module Wiring

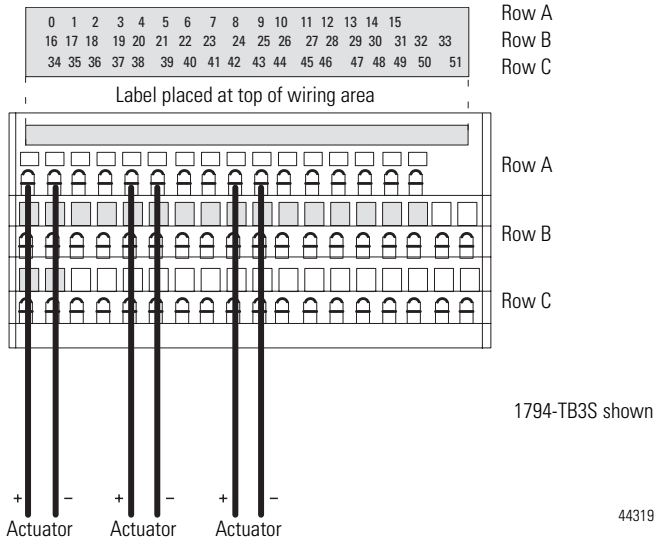

Wire Connections

Channel	Signal Type	Label Markings	Catalog Numbers 1794-TB3 or 1794-TB3S Terminal
0	Current	00	A-0
	Current	00 Ret	A-1
1	Current	01	A-2
	Current	01 Ret	A-3
2	Current	02	A-4
	Current	02 Ret	A-5
3	Current	03	A-6
	Current	03 Ret	A-7

Wire Connections

Channel	Signal Type	Label Markings	Catalog Numbers 1794-TB3 or 1794-TB3S Terminal
4	Current	04	A-8
	Current	04 Ret	A-9
5	Current	05	A-10
	Current	05 Ret	A-11
6	Current	06	A-12
	Current	06 Ret	A-13
7	Current	07	A-14
	Current	07 Ret	A-15
-V DC common	For catalog numbers 1794-TB3 and 1794-TB3S, terminals B-16...33 are internally connected in the terminal base unit.		
+V DC power	For catalog numbers 1794-TB3 and 1794-TB3S, terminals C-34...51 are internally connected in the terminal base unit.		

Input Map

Word	Bit															
	15	14	13	12	11	10	9	8	7	6	5	4	3	2	1	0
0	F7	F6	F5	F4	F3	F2	F1	F0	Diagnostic Status							
1	Reserved															
2	C7	C6	C5	C4	C3	C2	C1	C0	Reserved							
3	X7	X6	X5	X4	X3	X2	X1	X0	Reserved							
Fn:	Channel n Wire Fault Alarm for open or short circuit ⁽¹⁾											0: False 1: True				
Cn:	Channel n HART Current Fault											0: False 1: True				
Xn:	HART Device Transmitter present											0: False 1: True				

Note: Reserved data may not be shown in certain controller software

- (1) This alarm is disabled in Analog 0...20 mA formats (Formats 0,1,3) or if "Wire Fault Detection" is not enabled in configuration.

Output Map

Word	Bit															
	15	14	13	12	11	10	9	8	7	6	5	4	3	2	1	0
0	R	G R	R	R	R	R	R	R	D G 7	D G 6	D G 5	D G 4	D G 3	D G 2	D G 1	D G 0
1	Channel 0 Output Data															
2	Channel 1 Output Data															
3	Channel 2 Output Data															
4	Channel 3 Output Data															
5	Channel 4 Output Data															
6	Channel 5 Output Data															
7	Channel 6 Output Data															
8	Channel 7 Output Data															
DGn:	Channel n Digital Output Data. Valid in Digital mode only.											0: Output 0 mA ⁽¹⁾ 1: Output 22 mA				
GR:	Global reset. Resets all latched wire fault alarms															
R	Reserved															

- (1) When Open Wire Detect is Enabled, 0 = 100 μ A on Output

AB Par

14 FLEX I/O Isolated Output HART Analog Module

Configuration Map

Word	Bit															
	15	14	13	12	11	10	9	8	7	6	5	4	3	2	1	0
0	FT	R	E W 7	E W 6	E W 5	E W 4	BOB ⁽¹⁾		R	R	E W 3	E W 2	E W 1	E W 0	BOA ⁽¹⁾	
1	D H 7	D H 6	D H 5	D H 4	D H 3	D H 2	D H 1	D H 0	Reserved							
2	CH 3 Format				CH 2 Format				CH 1 Format				CH 0 Format			
3	CH 7 Format				CH 6 Format				CH 5 Format				CH 4 Format			
4	CH1 HART Current Ratio					L1	AFS1		CH0 HART Current Ratio					L0	AFS0	
5	CH3 HART Current Ratio					L3	AFS3		CH2 HART Current Ratio					L2	AFS2	
6	CH5 HART Current Ratio					L5	AFS5		CH4 HART Current Ratio					L4	AFS4	
7	CH7 HART Current Ratio					L7	AFS7		CH6 HART Current Ratio					L6	AFS6	
8	D F 7	D F 6	D F 5	D F 4	D F 3	D F 2	D F 1	D F 0	D M 7	D M 6	D M 5	D M 4	D M 3	D M 2	D M 1	D M 0
9	Channel 0 Analog Fault Value Output Data															
10	Channel 1 Analog Fault Value Output Data															
11	Channel 2 Analog Fault Value Output Data															
12	Channel 3 Analog Fault Value Output Data															
13	Channel 4 Analog Fault Value Output Data															
14	Channel 5 Analog Fault Value Output Data															
15	Channel 6 Analog Fault Value Output Data															

Configuration Map

Word	Bit															
	15	14	13	12	11	10	9	8	7	6	5	4	3	2	1	0
16	Channel 7 Analog Fault Value Output Data															
17	Reserved								C	C	C	C	C	C	C	C
									7	6	5	4	3	2	1	0

Note: Reserved data may not be shown in certain controller software

⁽¹⁾ not shown or used in RSLogix 5000.

Configuration Map descriptions

BOA BOB	Byte order group A Byte order group B	Byte order group A and B values must match each other. Refer to the Byte Order table	
FT	LocalFaultMode	0: Outputs set to safe value on communication faults only	1: Outputs set to safe value on any fault
EWn	Fault Enable for wire fault detection on channel n. ⁽¹⁾	0: Disable wire off/lead break detection	1: Enable wire off/lead break detection ⁽²⁾
CHn HART Current Ratio	HART current fault ratio limit on channel n	Valid values are 0, or 5...31 percent of full scale. A value of 0 disables this feature. Refer to the HART Current Ratio table for more information.	
AFSn	Channel n Analog Fault Mode Selection	Refer to the Channel Analog Fault Mode Selection table	
Ln	Channel n Enable Latching of wire fault	0: Unlatched	1: Latched
DFn	Channel n Digital Fault Mode Selection	0: Reset (0 mA)	1: Hold Last State
DMn	Channel n Enable Digital Mode	0: Analog	1: Digital
Fn:	Fault mode channel n	0: Local/Remote faults disabled	1: Enabled

Configuration Map descriptions

DHn:	Disable HART communications on channel n	0: HART communications enabled	1: HART communications disabled
Cn:	HART CMD 3 Disable	0: HART CMD 3 communications enabled	1: HART CMD 3 communications disabled
R:	Reserved		
CH N Format	Refer to the Channel Data Formats table		

(1) Not supported in Analog 0...20 mA formats

(2) Lead break must be present for 100 ms or more

Byte Order

Byte Order Group B		Byte Order Group A		Description
Bit 9	Bit 8	Bit 1	Bit 0	
0	0	0	0	Little Endian Format (default) — all data entries in true Little Endian format
1	0	1	0	Word Swap — word swap only values requiring more than one word, for example, 32 bit float values.
0	1	0	1	Byte Swap — byte swap all words in data table.
1	1	1	1	Big Endian Format — all data entries in true Big Endian format.

Channel Analog Fault Mode Selection

Analog Fault Mode	Decimal Value	Bits	
		9	8
		1	0
Min Scale	0	0	0
Max Scale	1	0	0
Hold Last State	2	1	0
User Specified Data Value	3	1	1

HART Current Ratio

HART Current Ratio Limit	Decimal Value	Bits				
		15	14	13	12	11
		7	6	5	4	3
Disabled	0	0	0	0	0	0
Not applicable	1	0	0	0	0	1
Not applicable	2	0	0	0	1	0
Not applicable	3	0	0	0	1	1
Not applicable	4	0	0	1	0	0
5%	5	0	0	1	0	1
6%	6	0	0	1	1	0
7%	7	0	0	1	1	1
8%	8	0	1	0	0	0
9%	9	0	1	0	0	1
10%	10	0	1	0	1	0
...
30%	30	1	1	1	1	0
31%	31	1	1	1	1	1

Channel Data Formats

Format (1)	Bits				Format Name	Signal Range		User Range		Resolution
	15	14	13	12		LO	HI	LO	HI	
	11	10	9	8						
	7	6	5	4						
3	2	1	0							
0	0	0	0	0	0...20 mA in Milliamps	0.00	22.00	0 (0.000 mA)	22000 (22.000 mA)	1.0 μ A
1	0	0	0	1	0...20 mA in % Full Scale	0.00	22.00	0 (0%)	11000 (110.00%)	2.0 μ A
3	0	0	1	1	0...20 mA in UINT	0.00	20.00	0	65535	0.3052 μ A
4 ⁽²⁾	0	1	0	0	4...20 mA in Milliamps	2.00	22.00	2000 (2.000 mA)	22000 (22.000 mA)	1.0 μ A
7 ⁽²⁾	0	1	1	1	4...20 mA in UINT	4.00	20.00	0	65535	0.2441 μ A
14 ⁽²⁾	1	1	1	0	4...20 mA in % Full Scale	2.00	22.00	-1250 (-12.50%)	11250 (112.50%)	1.6 μ A

(1) All other formats are invalid.

(2) HART Communications supported with these data formats only.

Format Values

Format	Format name	0.0 mA	2.0 mA	4.0 mA	20.0 mA	22.0 mA
0	0...20 mA in Milliamps	0	2000	4000	20000	22000
1	0...20 mA in % Full Scale	0	1000	2000	10000	11000
3	0...20 mA in UINT	0	6554	13107	65535	65535 ⁽¹⁾
4	4...20 mA in Milliamps	2000 ⁽¹⁾	2000	4000	20000	22000
7	4...20 mA in UINT	0 ⁽¹⁾	0 ⁽¹⁾	0	65535	65535 ⁽¹⁾
14	4...20 mA in % Full Scale	-1250 ⁽¹⁾	-1250	0	10000	11250

⁽¹⁾ These values are under, or over the supported user range, and are clamped at the lowest/highest supported values.

Cyclic HART Input Data

The HART input data holds the primary variables for the "live" HART device, and other information gathered during the normal HART scan. Additional "documentary" data is available through the pass through message interface in the device information tables. Pass through messages are defined in detail in the User Manual.

IMPORTANT

The HART Input Data for a channel may be zeroes if HART communications is disabled for that channel. For more information on disabling HART communications, refer to the Disable HART communications and HART CMD 3 Disable functions in the Configuration Map table.

AB Par

HART Input Data

Word	Bit																	
	15	14	13	12	11	10	9	8	7	6	5	4	3	2	1	0		
0	Reserved								C	C	C	C	C	C	C	C	(HART CMD 3 Communications Status)	
									H	H	H	H	H	H	H	H		
									7	6	5	4	3	2	1	0		
1	Reserved																	
2	CHO HART Field Device Status								CHO HART Comm Status									
3	Reserved				F	T	S	P	CHO HART Loop Status									
					V	V	V	V										
					A	A	A	A										
4	CHO HART Primary Value (IEEE 754-1985 Single-Precision 32 bit floating point)																	
5																		
6	CHO HART Secondary Value (IEEE 754-1985 Single-Precision 32 bit floating point)																	
7																		
8	CHO HART Tertiary Value (IEEE 754-1985 Single-Precision 32 bit floating point)																	
9																		
10	CHO HART Fourth (Quaternary) Value (IEEE 754-1985 Single-Precision 32 bit floating point)																	
11																		
12	CHO SV Units Code								CHO PV Units Code									
13	CHO FV Units Code								CHO TV Units Code									
14... 25	Words 2...13 for channel 1																	
26... 37	Words 2...13 for channel 2																	
38... 49	Words 2...13 for channel 3																	

HART Input Data

Word	Bit														
	15	14	13	12	11	10	9	8	7	6	5	4	3	2	1
50... 61	Words 2...13 for channel 4														
62... 73	Words 2...13 for channel 5														
74... 85	Words 2...13 for channel 6														
86... 97	Words 2...13 for channel 7														

AB Par

HART Input Data descriptions

CHn: HART CMD 3 Communication Status	0: HART CMD3 Communication Disabled or No Error	1: HART CMD3 Communication Error between Adapter & Module
CHn: HART Comm Status (HART CMD3 Response first status byte):	Refer to User Manual	
CHn: HART Field Device Status (HART CMD3 Response second status byte):	Refer to User Manual	
HART Loop Status:		
Bit 0: HART enable	0: Disabled	1: Enabled
Bit 1: Device Connected	0: Not Connected	1: Connected
Bit 2: Response Error	0: No HART message failure	1: Response ended in error
Bit 3: CMD 48 Update	0: CMD 48 not updated	1: CMD 48 updated
Bit 4: HART Loop Tolerance Error	0: No HART Current Fault	1: HART Current Fault
Bit 5: HART Update	0: HART Device information not updated	1: HART Device information updated since last read
Bit 6: HART message	0: No new message	1: HART user message queue has completed a message
Bit 7:		Reserved
PVA — The primary variable for this channel has been acquired.		
SVA — The secondary variable for this channel has been acquired.		
TVA — The tertiary variable for this channel has been acquired.		
FVA — The fourth (quaternary) variable for this channel has been acquired.		

Status Indicator

The OK status indicator is bicolor, red, and green. The indicator flashes green for these reasons:

- The module configuration word is zero (for example, powerup reset condition).
- The 24V DC user power is off.
- The module is in Configuration mode.

The indicator displays red to indicate the module did not pass the initial hardware test. Recycle power in response to this display.

After powerup, if the status indicator is not flashing green or solid green, recycle module power to verify a proper reset of the bus interface.

Specifications

FLEX I/O Isolated Output Analog Module - 1794-OF8IH

Attribute	Value
Number of outputs	8 isolated
Module base	Catalog numbers 1794-TB3, 1794-TB3S
Resolution	16 bits - unipolar
Current	0.305 μ A/cnt unipolar
Data format	Engineering Units ⁽³⁾ Percent of Full Scale RAW/Proportional Count
Update rate	10 ms
Output current terminal	4...20 mA (user configurable) 0...20 mA (user configurable)
Settling Time	70 ms, 0...99.9%
Load resistance	0 Ω ... 750 Ω standard
Load reactance, max	10 μ H

FLEX I/O Isolated Output Analog Module - 1794-OF8IH

Attribute	Value
Absolute accuracy	$\pm 0.1\%$ Full Scale @ 25 °C $\pm 0.35\%$ Full Scale @ 0 °C...55 °C
Accuracy drift with temperature ⁽¹⁾	$\pm 0.008\%$ /°C 0.0038 Full Scale /°C
Calibration required	Factory calibrated
Overload, max	30V continuous or 32 mA continuous, one channel at a time
Indicators	1 red/green power/status indicator
Isolation voltage	120V (continuous), Basic Insulation Type Type tested at 1000V ac for 60 s, between User power to system, channel to system, and channel to channel
Flexbus current	80 mA
External power supply voltage range	19.2...31.2V DC
External power supply current	450 mA @ 24V DC
Power dissipation, max	5.0 W @ 31.2V DC
Thermal dissipation, max	6.8 BTU/hr @31.2V DC
Enclosure type rating	None (open-style)
Terminal block screw torque	Determined by installed terminal base
Wire size	Determined by installed terminal base
Wiring category ⁽²⁾	2 on signal ports 3 on power ports
Wire type	Shielded on signal ports
Keyswitch position	4

FLEX I/O Isolated Output Analog Module - 1794-OF8IH

Attribute	Value
North American temperature code	T4
IEC Temp Code	T4
Dimensions (HxWxD), approx.	94.0 x 94.0 x 66.0 mm (3.7 x 3.7 x 2.6 in.) with module installed in base

- (1) Includes offset, gain, nonlinearity, and repeatability error terms.
- (2) Use this Conductor Category information for planning conductor routing. Refer to Industrial Automation Wiring and Grounding Guidelines, publication 1770-4.1. The phase conductor is 0.34...2.5 mm². The ground conductor must be equal to or greater than the phase conductor.
- (3) Engineering Units apply to HART data only.

Environmental

Attribute	Value
Temperature, operating	IEC 60068-2-1 (Test Ad, Operating Cold), IEC 60068-2-2 (Test Bd, Operating Dry Heat), IEC 60068-2-14 (Test Nb, Operating Thermal Shock): 0...55 °C (32...131 °F)
Temperature, nonoperating	IEC 60068-2-1 (Test Ab, Unpackaged Nonoperating Cold), IEC 60068-2-2 (Test Bb, Unpackaged Nonoperating Dry Heat) IEC 60068-2-14 (Test Na, Unpackaged Nonoperating Thermal Shock): -40...85 °C (-40...185 °F)
Relative humidity	IEC 60068-2-30 (Test Db, Unpackaged Damp Heat): 5...95% non-condensing
Vibration	IEC 60068-2-6 (Test Fc, Operating): 5 g @ 10...500 Hz
Shock, operating	IEC 60068-2-27 (Test Ea, Unpackaged Shock): 20 g

Environmental

Attribute	Value
Shock, nonoperating	IEC 60068-2-27 (Test Ea, Unpackaged Shock): 25 g
Emissions	CISPR 11: Group 1, Class A
ESD Immunity	IEC 61000-4-2: 6 kV contact discharges 8 kV air discharges
Radiated RF Immunity	IEC 61000-4-3: 10V/m with 1 kHz sine-wave 80% AM from 80...2000 MHz 10V/m with 200 Hz 50% Pulse 100% AM at 900 MHz 10V/m with 200 Hz 50% Pulse 100% AM at 1890 MHz 3V/m with 1 kHz sine-wave 80% AM from 2000...2700 MHz
EFT/B Immunity	IEC 61000-4-4: ±3 kV at 5 kHz on signal ports
Surge Transient Immunity	IEC 61000-4-5: ±2 kV line-earth(CM) on shielded ports
Conducted RF Immunity	IEC 61000-4-6: 10V rms with 1 kHz sine-wave 80%AM from 150 kHz...80 MHz



Certifications

Certification (when product is marked) ⁽¹⁾	Value
c-UL-us	<p>UL Listed Industrial Control Equipment, certified for US and Canada. See UL File E65584.</p> <p>UL Listed for Class I, Division 2 Group A,B,C,D Hazardous Locations, certified for U.S. and Canada. See UL File E194810..</p>
CE	<p>European Union 2004/108/EC EMC Directive, compliant with: EN 61326-1; Meas./Control/Lab., Industrial Requirements EN 61000-6-2; Industrial Immunity EN 61000-6-4; Industrial Emissions EN 61131-2; Programmable Controllers (Clause 8, Zone A & B)</p> <p>European Union 2006/95/EC LVD, compliant with: EN 61131-2; Programmable Controllers (Clause 11)</p>
C-Tick	<p>Australian Radiocommunications Act, compliant with: AS/NZS CISPR 11; Industrial Emissions</p>
Ex	<p>European Union 94/9/EC ATEX Directive, compliant with: EN 60079-15; Potentially Explosive Atmospheres, Protection "n" (II 3 G Ex nA IIC T4 X) EN 60079-0; General Requirements (Zone 2)</p>

⁽¹⁾ See the Product Certification link at <http://www.ab.com> for Declaration of Conformity, Certificates, and other certification details.

Rockwell Automation Support

Rockwell Automation provides technical information on the Web to assist you in using its products. At <http://support.rockwellautomation.com>, you can find technical manuals, a knowledge base of FAQs, technical and application notes, sample code and links to software service packs, and a MySupport feature that you can customize to make the best use of these tools.

For an additional level of technical phone support for installation, configuration, and troubleshooting, we offer TechConnect support programs. For more information, contact your local distributor or Rockwell Automation representative, or visit <http://support.rockwellautomation.com>.

Installation Assistance

If you experience a problem within the first 24 hours of installation, please review the information that's contained in this manual. You can also contact a special Customer Support number for initial help in getting your product up and running.

United States	1.440.646.3434 Monday – Friday, 8 a.m. – 5 p.m. EST
Outside United States	Please contact your local Rockwell Automation representative for any technical support issues.

New Product Satisfaction Return

Rockwell Automation tests all of its products to ensure that they are fully operational when shipped from the manufacturing facility. However, if your product is not functioning and needs to be returned, follow these procedures.

United States	Contact your distributor. You must provide a Customer Support case number (see phone number above to obtain one) to your distributor in order to complete the return process.
Outside United States	Please contact your local Rockwell Automation representative for the return procedure.

Allen-Bradley, Rockwell Automation, TechConnect, and FLEX I/O are trademarks of Rockwell Automation, Inc.
Trademarks not belonging to Rockwell Automation are property of their respective companies.

www.rockwellautomation.com

Power, Control and Information Solutions Headquarters

Americas: Rockwell Automation, 1201 South Second Street, Milwaukee, WI 53204-2496 USA, Tel: (1) 414.382.2000, Fax: (1) 414.382.4444
Europe/Middle East/Africa: Rockwell Automation, Vorstlaan/Boulevard du Souverain 36, 1170 Brussels, Belgium, Tel: (32) 2 663 0600, Fax: (32) 2 663 0640
Asia Pacific: Rockwell Automation, Level 14, Core F, Cyberport 3, 100 Cyberport Road, Hong Kong, Tel: (852) 2887 4788, Fax: (852) 2508 1846