

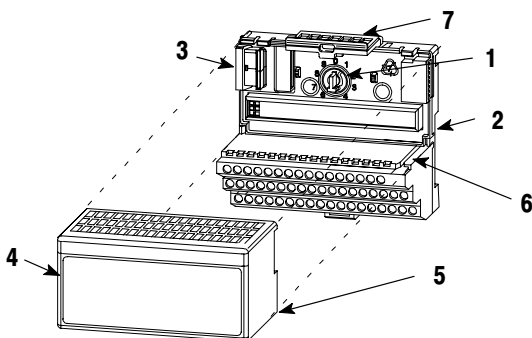

Installation Instructions

24V dc FLEX I/O 16 Sink Output Module (Cat. No. 1794-OV16)

English



Module Installation

This module mounts on a 1794 terminal base unit.

1. Rotate keyswitch (1) on terminal base unit (2) clockwise to position 2 as required for this type of module.
2. Make certain the flexbus connector (3) is pushed all the way to the left to connect with the neighboring terminal base/adaptor. **You cannot install the module unless the connector is fully extended.**
3. Make sure that the pins on the bottom of the module are straight so they will align properly with the connector in the terminal base unit.
4. Position the module (4) with its alignment bar (5) aligned with the groove (6) on the terminal base.
5. Press firmly and evenly to seat the module in the terminal base unit. The module is seated when the latching mechanism (7) is locked into the module.



ATTENTION: To use this module in a complementary I/O system, refer to your Remote I/O Adapter module documentation.



ATTENTION: Remove field-side power before removing or inserting this module. This module is designed so you can **remove and insert it under backplane power**. When you remove or insert a module with field-side power applied, an electrical arc may occur. An electrical arc can cause personal injury or property damage by:

- sending an erroneous signal to your system's field devices causing unintended machine motion
- causing an explosion in a hazardous environment

Repeated electrical arcing causes excessive wear to contacts on both the module and its mating connector. Worn contacts may create electrical resistance.

European Union Directive Compliance

If this product has the CE mark it is approved for installation within the European Union and EEA regions. It has been designed and tested to meet the following directives.

EMC Directive

This product is tested to meet Council Directive 89/336/EEC Electromagnetic Compatibility (EMC) and the following standards, in whole or in part, documented in a technical construction file:

- EN 50081-2 EMC – Generic Emission Standard, Part 2 – Industrial Environment
- EN 50082-2 EMC – Generic Immunity Standard, Part 2 – Industrial Environment

This product is intended for use in an industrial environment.

Low Voltage Directive

This product is tested to meet Council Directive 73/23/EEC Low Voltage, by applying the safety requirements of EN 61131-2 Programmable Controllers, Part 2 – Equipment Requirements and Tests.

For specific information required by EN 61131-2, see the appropriate sections in this publication, as well as the following Allen-Bradley publications:

- Industrial Automation Wiring and Grounding Guidelines For Noise Immunity, publication 1770-4.1
- Automation Systems Catalog, publication B111

This equipment is classified as open equipment and must be mounted in an enclosure during operation to provide safety protection.

Wiring to a 1794-TB2, -TB3 or -TB3S Terminal Base Unit

1. Connect individual wiring to numbered terminals on the **0-15** row (A) as indicated in the table on the following page.
2. Connect the associated +24V dc power to the corresponding terminal on the **34-51** row (C) as indicated in the table on the following page. (Power terminals are internally connected together.)
3. Connect +24V dc power to terminal 34 on the **34-51** row (C).
4. Connect dc return to terminal 16 on the **16-33** row (B).
5. If continuing power to the next terminal base unit, connect a jumper from terminal 51 (+24V dc) on this base unit to terminal 34 on the next base unit.
6. If continuing common to the next terminal base unit, connect a jumper from terminal 33 (common) on this base unit to terminal 16 on the next base unit.

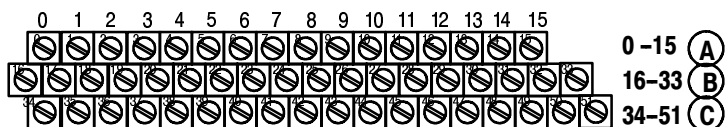

1794-TB3

0	1	2	3	4	5	6	7	8	9	10	11	12	13	14	15	Row A		
16	17	18	19	20	21	22	23	24	25	26	27	28	29	30	31	32	33	Row B
34	35	36	37	38	39	40	41	42	43	44	45	46	47	48	49	50	51	Row C

Label placed at top of wiring area.

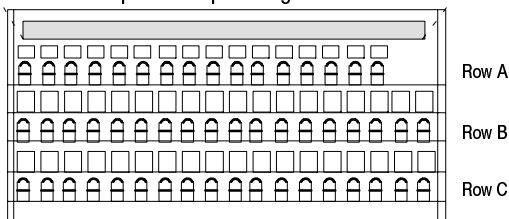

1794-TB3S



ATTENTION: Total current draw through the terminal base unit is limited to 10A. Separate power connections to the terminal base unit may be necessary.

4 24V dc FLEX I/O 16 Sink Output Module

Output	Output Terminal	Power Terminal	Output	Output Terminal	Power Terminal
Output 0	A-0	C-35	Output 8	A-8	C-43
Output 1	A-1	C-36	Output 9	A-9	C-44
Output 2	A-2	C-37	Output 10	A-10	C-45
Output 3	A-3	C-38	Output 11	A-11	C-46
Output 4	A-4	C-39	Output 12	A-12	C-47
Output 5	A-5	C-40	Output 13	A-13	C-48
Output 6	A-6	C-41	Output 14	A-14	C-49
Output 7	A-7	C-42	Output 15	A-15	C-50
Common	B-16 thru B-33		+24v dc	C-34 thru C-51	

Indicators

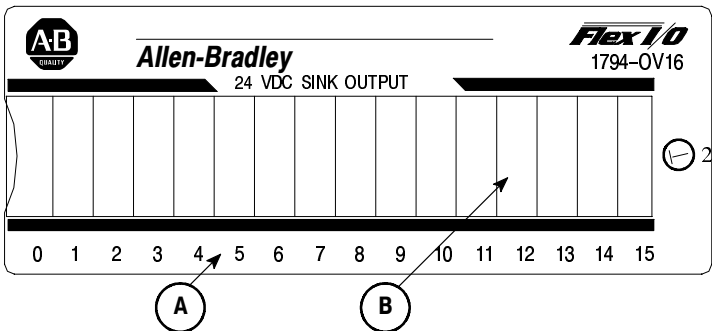







A = Status Indicators - show status of individual outputs.

B = Insertable label for writing individual output designations.

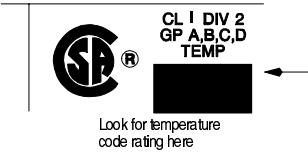
Memory Mapping

Bit⇒ Word↓	15	14	13	12	11	10	09	08	07	06	05	04	03	02	01	00
Read	Not used															
Write	O15	O14	O13	O12	O11	O10	O9	O8	O7	O6	O5	O4	O3	O2	O1	O0
Where:	O = Output value															

CSA Hazardous Location Approval	Approbation d'utilisation dans des emplacements dangereux par la CSA
<p>CSA® certifies products for general use as well as for use in hazardous locations. Actual CSA certification is indicated by the product label as shown below, and not by statements in any user documentation.</p>	<p>La CSA® certifie les produits d'utilisation générale aussi bien que ceux qui s'utilisent dans des emplacements dangereux. La certification CSA en vigueur est indiquée par l'étiquette du produit et non par des affirmations dans la documentation à l'usage des utilisateurs.</p>
<p>Example of the CSA certification product label</p> 	<p>Exemple d'étiquette de certification d'un produit par la CSA</p> 
<p>To comply with CSA certification for use in hazardous locations, the following information becomes a part of the product literature for CSA-certified Allen-Bradley industrial control products.</p> <ul style="list-style-type: none"> • This equipment is suitable for use in Class I, Division 2, Groups A, B, C, D, or non-hazardous locations only. • The products having the appropriate CSA markings (that is, Class I Division 2, Groups A, B, C, D), are certified for use in other equipment where the suitability of combination (that is, application or use) is determined by the CSA or the local inspection office having jurisdiction. 	<p>Pour satisfaire à la certification de la CSA dans des endroits dangereux, les informations suivantes font partie intégrante de la documentation des produits industriels de contrôle Allen-Bradley certifiés par la CSA.</p> <ul style="list-style-type: none"> • Cet équipement convient à l'utilisation dans des emplacements de Classe I, Division 2, Groupes A, B, C, D, ou ne convient qu'à l'utilisation dans des endroits non dangereux. • Les produits portant le marquage approprié de la CSA (c'est à dire, Classe I, Division 2, Groupes A, B, C, D) sont certifiés à l'utilisation pour d'autres équipements où la convenance de combinaison (application ou utilisation) est déterminée par la CSA ou le bureau local d'inspection qualifié.
<p>Important: Due to the modular nature of a PLC® control system, the product with the highest temperature rating determines the overall temperature code rating of a PLC control system in a Class I, Division 2 location. The temperature code rating is marked on the product label as shown.</p>	<p>Important: Par suite de la nature modulaire du système de contrôle PLC®, le produit ayant le taux le plus élevé de température détermine le taux d'ensemble du code de température du système de contrôle d'un PLC dans un emplacement de Classe I, Division 2. Le taux du code de température est indiqué sur l'étiquette du produit.</p>
<p>Temperature code rating</p>  <p>Look for temperature code rating here</p>	<p>Taux du code de température</p>  <p>Le taux du code de température est indiqué ici</p>
<p>The following warnings apply to products having CSA certification for use in hazardous locations.</p>	<p>Les avertissements suivants s'appliquent aux produits ayant la certification CSA pour leur utilisation dans des emplacements dangereux.</p>

CSA Hazardous Location Approval	Approbation d'utilisation dans des emplacements dangereux par la CSA
 <p>ATTENTION: Explosion hazard —</p> <ul style="list-style-type: none"> • Substitution of components may impair suitability for Class I, Division 2. • Do not replace components unless power has been switched off or the area is known to be non-hazardous. • Do not disconnect equipment unless power has been switched off or the area is known to be non-hazardous. • Do not disconnect connectors unless power has been switched off or the area is known to be non-hazardous. Secure any user-supplied connectors that mate to external circuits on an Allen-Bradley product using screws, sliding latches, threaded connectors, or other means such that any connection can withstand a 15 Newton (3.4 lb.) separating force applied for a minimum of one minute. 	 <p>AVERTISSEMENT: Risque d'explosion —</p> <ul style="list-style-type: none"> • La substitution de composants peut rendre ce matériel inacceptable pour les emplacements de Classe I, Division 2. • Couper le courant ou s'assurer que l'emplacement est désigné non dangereux avant de remplacer les composants. • Avant de débrancher l'équipement, couper le courant ou s'assurer que l'emplacement est désigné non dangereux. • Avant de débrancher les connecteurs, couper le courant ou s'assurer que l'emplacement est reconnu non dangereux. Attacher tous connecteurs fournis par l'utilisateur et reliés aux circuits externes d'un appareil Allen-Bradley à l'aide de vis, loquets coulissants, connecteurs filetés ou autres moyens permettant aux connexions de résister à une force de séparation de 15 newtons (3,4 lb. - 1,5 kg) appliquée pendant au moins une minute.

Le sigle CSA est la marque déposée de l'Association des Standards pour le Canada.

PLC est une marque déposée de Allen-Bradley Company, Inc.

CSA logo is a registered trademark of the Canadian Standards Association

PLC is a registered trademark of Allen-Bradley Company, Inc.

Specifications – 24V dc Output Module Cat. No. 1794-OV16

Number of Outputs	16 (1 group of 16), non-isolated, sinking
Module Location	Cat. No. 1794-TB3 , -TB3S Terminal Base Unit
ON-state Voltage Range	10V dc minimum 24V dc nominal; 31.2V dc maximum
Output Current Rating	8A (16 outputs @ 0.5A)
OFF-state Voltage	31.2V dc maximum
ON-state Current	1.0mA minimum per channel 500mA maximum per channel
Surge Current	2A for 50ms, repeatable every 2 seconds
OFF-state Leakage	0.5mA maximum
ON-state Voltage Drop	0.2V dc maximum
Isolation Voltage (minimum)	100% tested at 2121V dc for 1s between user and system No isolation between individual channels
Output Signal Delay	
Off to On	0.5ms maximum
On to Off	1.0ms maximum
Flexbus Current (maximum)	80mA
Power Dissipation	4.2W maximum @ 31.2V
Thermal Dissipation	14.3 BTU/hr @ 31.2V dc
Indicators (field side indication, logic driven)	16 yellow status indicators
Keyswitch Position	2
Fuse recommendations ¹	Fusing of outputs is recommended. Use SAN-O MQ4-800 800mA fuses

Specifications continued on next page.

Specifications – 24V dc Output Module Cat. No. 1794-OV16

General Specifications

External dc Power		
	Supply Voltage	24V dc nominal
	Voltage Range	19.2 to 31.2V dc (includes 5% ac ripple)
	Supply Current	49mA @ 24V dc (38 to 65mA)
Dimensions	Inches	1.8H x 3.7W x 2.1D
	(Millimeters)	(45.7 x 94.0 x 53.3)
Environmental Conditions		
	Operational Temperature	0 to 55°C (32 to 131°F)
	Storage Temperature	-40 to 85°C (-40 to 185°F)
	Relative Humidity	5 to 95% noncondensing
Shock	Operating	30 g peak acceleration, 11(±1)ms pulse width
	Non-operating	50 g peak acceleration, 11(±1)ms pulse width
Vibration		Tested 5 g @ 10–500Hz per IEC 68-2-6
Conductors	Wire Size	12 gauge (4mm ²) stranded maximum
	Category	3/64 inch (1.2mm) insulation maximum 2 ²
Agency Certification (when product is marked)		<ul style="list-style-type: none"> • CSA certified • CSA Class I, Division 2, Groups A, B, C, D certified Hazardous Locations • UL listed • CE marked for all applicable directives
<p>¹ Module outputs are not fused. Fusing of outputs is recommended. If fusing is desired, you must provide external fusing.</p> <p>² You use this conductor category information for planning conductor routing. Refer to publication 1770-4.1, "Industrial Automation Wiring and Grounding Guidelines for Noise Immunity."</p>		



With major offices worldwide.

World Headquarters,
 Allen-Bradley,
 1201 South Second Street,
 Milwaukee, WI 53204 USA,
 Tel: (1) 414 382-2000 Fax: (1) 414 382-4444