

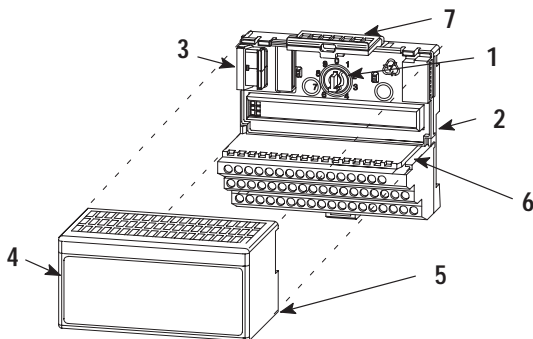

Installation Instructions

English

120V ac FLEX I/O 16 Output Module (Cat. No. 1794-OA16)



Module Installation

This module mounts on a 1794 terminal base unit.

1. Rotate keyswitch (1) on terminal base unit (2) clockwise to position 8 as required for this type of module.
2. Make certain the flexbus connector (3) is pushed all the way to the left to connect with the neighboring terminal base/adaptor. **You cannot install the module unless the connector is fully extended.**
3. Make sure that the pins on the bottom of the module are straight so they will align properly with the connector in the terminal base unit.
4. Position the module (4) with its alignment bar (5) aligned with the groove (6) on the terminal base.
5. Press firmly and evenly to seat the module in the terminal base unit. The module is seated when the latching mechanism (7) is locked into the module.



ATTENTION: To use this module in a complementary I/O system, refer to your Remote I/O Adapter module documentation.



ATTENTION: Remove field-side power before removing or inserting this module. This module is designed so you can **remove and insert it under backplane power**. When you remove or insert a module with field-side power applied, an electrical arc may occur. An electrical arc can cause personal injury or property damage by:

- sending an erroneous signal to your system's field devices causing unintended machine motion
- causing an explosion in a hazardous environment

Repeated electrical arcing causes excessive wear to contacts on both the module and its mating connector. Worn contacts may create electrical resistance.

European Union Directive Compliance

If this product has the CE mark it is approved for installation within the European Union and EEA regions. It has been designed and tested to meet the following directives.

EMC Directive

This product is tested to meet Council Directive 89/336/EEC Electromagnetic Compatibility (EMC) and the following standards, in whole or in part, documented in a technical construction file:

- EN 50081-2 EMC – Generic Emission Standard, Part 2 – Industrial Environment
- EN 50082-2 EMC – Generic Immunity Standard, Part 2 – Industrial Environment

This product is intended for use in an industrial environment.

Low Voltage Directive

This product is tested to meet Council Directive 73/23/EEC Low Voltage, by applying the safety requirements of EN 61131-2 Programmable Controllers, Part 2 – Equipment Requirements and Tests.

For specific information required by EN 61131-2, see the appropriate sections in this publication, as well as the following Allen-Bradley publications:

- Industrial Automation Wiring and Grounding Guidelines For Noise Immunity, publication 1770-4.1
- Automation Systems Catalog, publication B111

This equipment is classified as open equipment and must be mounted in an enclosure during operation to provide safety protection.

Wiring to a 1794-TB2, -TB3 or -TB3S Terminal Base Unit

1. Connect individual output wiring to numbered terminals on the **0–15** row (A) as indicated in the table below.
2. Connect the associated output common to the corresponding terminal on the **16–33** row (B) for each output as indicated in the table below. (Commons are internally connected together.)



ATTENTION: If using 0.5A outputs, alternate the wiring so that no two 0.5A outputs are next to each other.

3. Connect 120V ac L1 to terminal 34 on the **34–51** row (C).
4. Connect 120V ac common L2 to terminal 16 on the **16–33** row (B).
5. If continuing power to the next terminal base unit, connect a jumper from terminal 51 (120V ac L1) on this base unit to terminal 34 on the next base unit.
6. If continuing common to the next terminal base unit, connect a jumper from terminal 33 (120V ac common L2) on this base unit to terminal 16 on the next base unit.

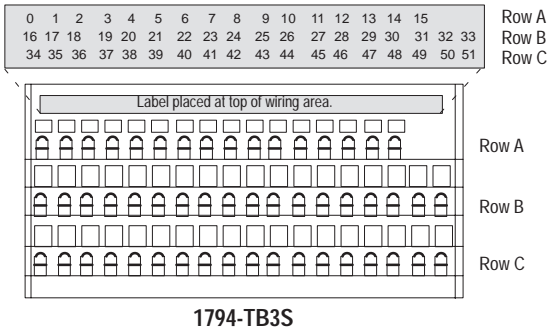
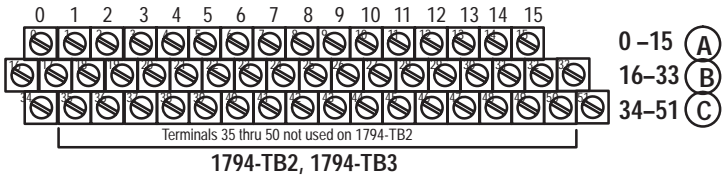

4 120V ac FLEX I/O 16 Output Module



ATTENTION: Total current draw through the terminal base unit is limited to 10A. Separate power connections to the terminal base unit may be necessary.

1794-TB2, -TB3, -TB3S					
Output Channel	Output Terminal	120V ac Common Terminal	Output Channel	Output Terminal	120V ac Common Terminal
0	A-0	B-17	8	A-8	B-25
1	A-1	B-18	9	A-9	B-26
2	A-2	B-19	10	A-10	B-27
3	A-3	B-20	11	A-11	B-28
4	A-4	B-21	12	A-12	B-29
5	A-5	B-22	13	A-13	B-30
6	A-6	B-23	14	A-14	B-31
7	A-7	B-24	15	A-15	B-32

A = output terminals

B = B-17 thru B-32 are internally connected together to 120V ac common L2.

C = Power terminals (C-34 and C-51 for 1794-TB2; C-34 thru 51 for 1794-TB3 and -TB3S) are internally connected together. Connect 120V ac L1 to terminal C-34.

Indicators

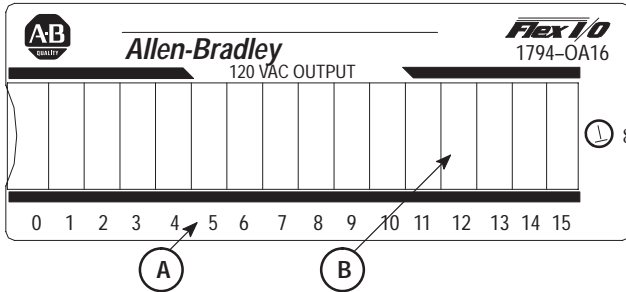

A = Status Indicators – yellow – show status of individual outputs.

B = Insertable label for writing individual output designations.

Image Table Memory Map

Dec.	15	14	13	12	11	10	09	08	07	06	05	04	03	02	01	00
Octal	17	16	15	14	13	12	11	10	07	06	05	04	03	02	01	00
Read	Not used – set to 0															
Write	O15	O14	O13	O12	O11	O10	O9	O8	O7	O6	O5	O4	O3	O2	O1	O0

Where O = Output number

CSA Hazardous Location Approval

CSA® certifies products for general use as well as for use in hazardous locations. **Actual CSA certification is indicated by the product label** as shown below, and not by statements in any user documentation.

Example of the CSA certification product label



To comply with CSA certification for use in hazardous locations, the following information becomes a part of the product literature for CSA-certified Allen-Bradley industrial control products.

- This equipment is suitable for use in Class I, Division 2, Groups A, B, C, D, or non-hazardous locations only.
 - The products having the appropriate CSA markings (that is, Class I Division 2, Groups A, B, C, D), are certified for use in other equipment where the suitability of combination (that is, application or use) is determined by the CSA or the local inspection office having jurisdiction.
-

Important: Due to the modular nature of a PLC® control system, the product with the highest temperature rating determines the overall temperature code rating of a PLC control system in a Class I, Division 2 location. The temperature code rating is marked on the product label as shown.

Temperature code rating

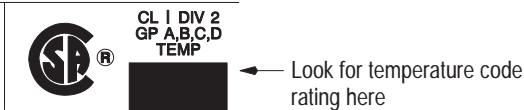

The following warnings apply to products having CSA certification for use in hazardous locations.

CSA Hazardous Location Approval



ATTENTION: Explosion hazard —

- Substitution of components may impair suitability for Class I, Division 2.
- Do not replace components unless power has been switched off or the area is known to be non-hazardous.
- Do not disconnect equipment unless power has been switched off or the area is known to be non-hazardous.
- Do not disconnect connectors unless power has been switched off or the area is known to be non-hazardous. Secure any user-supplied connectors that mate to external circuits on an Allen-Bradley product using screws, sliding latches, threaded connectors, or other means such that any connection can withstand a 15 Newton (3.4 lb.) separating force applied for a minimum of one minute.

Approbation d'utilisation dans des emplacements dangereux par la CSA

La CSA[®] certifie les produits d'utilisation générale aussi bien que ceux qui s'utilisent dans des emplacements dangereux. **La certification CSA en vigueur est indiquée par l'étiquette du produit** et non par des affirmations dans la documentation à l'usage des utilisateurs.

Exemple d'étiquette de certification d'un produit par la CSA



Pour satisfaire à la certification de la CSA dans des endroits dangereux, les informations suivantes font partie intégrante de la documentation des produits industriels de contrôle Allen-Bradley certifiés par la CSA.

- Cet équipement convient à l'utilisation dans des emplacements de Classe I, Division 2, Groupes A, B, C, D, ou ne convient qu'à l'utilisation dans des endroits non dangereux.
- Les produits portant le marquage approprié de la CSA (c'est à dire, Classe I, Division 2, Groupes A, B, C, D) sont certifiés à l'utilisation pour d'autres équipements où la convenance de combinaison (application ou utilisation) est déterminée par la CSA ou le bureau local d'inspection qualifié.

Important: Par suite de la nature modulaire du système de contrôle PLC[®], le produit ayant le taux le plus élevé de température détermine le taux d'ensemble du code de température du système de contrôle d'un PLC dans un emplacement de Classe I, Division 2. Le taux du code de température est indiqué sur l'étiquette du produit.

CSA Hazardous Location Approval

Approbation d'utilisation dans des emplacements dangereux par la CSA

Taux du code de température

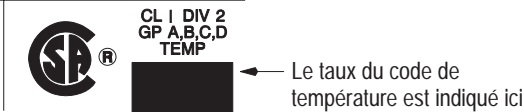

Les avertissements suivants s'appliquent aux produits ayant la certification CSA pour leur utilisation dans des emplacements dangereux.



AVERTISSEMENT: Risque d'explosion —

- La substitution de composants peut rendre ce matériel inacceptable pour les emplacements de Classe I, Division 2.
- Couper le courant ou s'assurer que l'emplacement est désigné non dangereux avant de remplacer les composants.
- Avant de débrancher l'équipement, couper le courant ou s'assurer que l'emplacement est désigné non dangereux.
- Avant de débrancher les connecteurs, couper le courant ou s'assurer que l'emplacement est reconnu non dangereux. Attacher tous connecteurs fournis par l'utilisateur et reliés aux circuits externes d'un appareil Allen-Bradley à l'aide de vis, loquets coulissants, connecteurs filetés ou autres moyens permettant aux connexions de résister à une force de séparation de 15 newtons (3,4 lb. - 1,5 kg) appliquée pendant au moins une minute.

Le sigle CSA est la marque déposée de l'Association des Standards pour le Canada.

PLC est une marque déposée de Allen-Bradley Company, Inc.

CSA logo is a registered trademark of the Canadian Standards Association

PLC is a registered trademark of Allen-Bradley Company, Inc.

Specifications – 120V ac Output Module Cat. No. 1794-OA16

Number of Outputs	16 non-isolated
Module Location	Cat. No. 1794-TB2, -TB3 or -TB3S Terminal Base
Mounting	See derating curve below.
Output Voltage Range	74-132V ac, 47-63Hz
Output Current Rating	4.0A (16 outputs @ 250mA) Attention: If using 0.5A outputs, alternate wiring so that no two 0.5A outputs are next to each other.
ON-state Current	50mA per output minimum; 500mA per output maximum @ 55°C
Maximum On-state Voltage Drop	1.5V ac @ 0.5A
Surge Current	7A for 40ms, repeatable every 8 seconds
Maximum OFF-state Leakage	2.25mA
Isolation Voltage	100% tested at 2150V ac for 1s between user and system No isolation between individual channels; No isolation between customer power and output channels
Output Signal Delay	
Off to On	1/2 cycle maximum
On to Off	1/2 cycle maximum
Flexbus Current (maximum)	80mA
Power Dissipation	4.7W maximum @ 0.5A

Specifications continued on next page.

10 120V ac FLEX I/O 16 Output Module

Specifications – 120V ac Output Module Cat. No. 1794-OA16

Thermal Dissipation	16.1 BTU/hr @ 0.5A
Indicators (field side indication, logic driven)	16 yellow status indicators
Keyswitch Position	8

General Specifications

External ac Power		
Supply Voltage		120V ac nominal
Input Frequency		47–63Hz
Voltage Range		74 to 132V ac
Dimensions	Inches (Millimeters)	1.8H x 3.7W x 2.1D (45.7 x 94.0 x 53.3)
Environmental Conditions		
Operational Temperature		0 to 55°C (32 to 131°F)
Storage Temperature		–40 to 85°C (–40 to 185°F)
Relative Humidity		5 to 95% noncondensing
Shock	Operating	30 g peak acceleration, 11(±1)ms pulse width
	Non-operating	50 g peak acceleration, 11(±1)ms pulse width
Vibration		Tested 5 g @ 10–500Hz per IEC 68-2-6
Conductors	Wire Size	12 gauge (4mm ²) stranded maximum
		3/64 inch (1.2mm) insulation maximum
	Category	1 ¹
Agency Certification (when product is marked)		<ul style="list-style-type: none">• CSA certified• CSA Class I, Division 2 Groups A, B, C, D certified• UL listed• CE marked for all applicable directives

¹ You use this conductor category information for planning conductor routing as described in publication 1770-4.1, "Industrial Automation Wiring and Grounding Guidelines for Noise Immunity."

Derating Curve

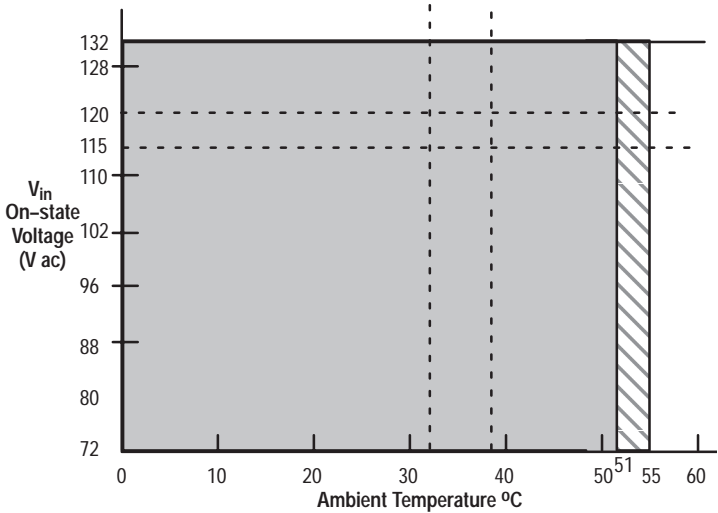

The area within the curve represents the safe operating range for the module under various conditions of user supplied 120V ac supply voltages and ambient temperatures.

 = Normal mounting safe operating range. Includes 

 = Other mounting positions (including inverted horizontal, vertical) safe operating range

Mounting	Temperature (maximum)
normal horizontal	55
Other mounting positions (including inverted horizontal, vertical)	51



Allen-Bradley

With major offices worldwide. 

World Headquarters,
Allen-Bradley,
1201 South Second Street,
Milwaukee, WI 53204 USA,
Tel: (1) 414 382-2000 Fax: (1) 414 382-4444