



**Allen-Bradley**

***Thermocouple/  
Millivolt Input  
Module***

***(Cat. No. 1794-IT8)***

# **User Manual**

**AB Parts**

## Important User Information

Because of the variety of uses for the products described in this publication, those responsible for the application and use of this control equipment must satisfy themselves that all necessary steps have been taken to assure that each application and use meets all performance and safety requirements, including any applicable laws, regulations, codes and standards.

The illustrations, charts, sample programs and layout examples shown in this guide are intended solely for example. Since there are many variables and requirements associated with any particular installation, Allen-Bradley does not assume responsibility or liability (to include intellectual property liability) for actual use based upon the examples shown in this publication.

Allen-Bradley publication SGI-1.1, “Safety Guidelines For The Application, Installation and Maintenance of Solid State Control” (available from your local Allen-Bradley office) describes some important differences between solid-state equipment and electromechanical devices which should be taken into consideration when applying products such as those described in this publication.

Reproduction of the contents of this copyrighted publication, in whole or in part, without written permission of Allen-Bradley Company, Inc. is prohibited.

Throughout this manual we make notes to alert you to possible injury to people or damage to equipment under specific circumstances.



**ATTENTION:** Identifies information about practices or circumstances that can lead to personal injury or death, property damage, or economic loss.

---

Attention helps you:

- identify a hazard
- avoid the hazard
- recognize the consequences

**Important:** Identifies information that is especially important for successful application and understanding of the product.

**Important:** We recommend you frequently backup your application programs on appropriate storage medium to avoid possible data loss.

DeviceNet, DeviceNetManager, and RediSTATION are trademarks of Allen-Bradley Company, Inc.

PLC, PLC-2, PLC-3, and PLC-5 are registered trademarks of Allen-Bradley Company, Inc.

Windows is a trademark of Microsoft.

Microsoft is a registered trademark of Microsoft

IBM is a registered trademark of International Business Machines, Incorporated.

All other brand and product names are trademarks or registered trademarks of their respective companies.

# Table of Contents

---

<b>Using This Manual</b> .....	<b><a href="#">P-1</a></b>
Preface Objectives .....	<a href="#">P-1</a>
Audience .....	<a href="#">P-1</a>
Vocabulary .....	<a href="#">P-1</a>
What This Manual Contains .....	<a href="#">P-1</a>
Conventions .....	<a href="#">P-2</a>
For Additional Information .....	<a href="#">P-2</a>
Summary .....	<a href="#">P-2</a>
<b>Overview of Flex I/O and your Thermocouple/mV Module</b> .	<b><a href="#">1-1</a></b>
Chapter Objectives .....	<a href="#">1-1</a>
The FLEX I/O System .....	<a href="#">1-1</a>
How FLEX I/O Analog Modules Communicate with Programmable Controllers .....	<a href="#">1-1</a>
Typical Communication Between an Adapter and a Module .....	<a href="#">1-2</a>
Features of your Modules .....	<a href="#">1-3</a>
Chapter Summary .....	<a href="#">1-3</a>
<b>How to Install Your Thermocouple/mV Input Module</b> .....	<b><a href="#">2-1</a></b>
Before You Install Your Input Module .....	<a href="#">2-1</a>
European Union Directive Compliance .....	<a href="#">2-1</a>
EMC Directive .....	<a href="#">2-1</a>
Low Voltage Directive .....	<a href="#">2-2</a>
Power Requirements .....	<a href="#">2-2</a>
Wiring the Terminal Base Units (1794-TB2 and -TB3 shown) ...	<a href="#">2-3</a>
Installing the Module .....	<a href="#">2-4</a>
Connecting Wiring for the Thermocouple/mV Module .....	<a href="#">2-5</a>
Table 2.A	
Wiring connections for the 1794-IT8 Thermocouple Input Module .....	<a href="#">2-6</a>
Example of Millivolt Input Wiring to a 1794-TB3 Terminal Base Unit .....	<a href="#">2-7</a>
Example of 3-wire Thermocouple Wiring to a 1794-TB3T Temperature Terminal Base Unit .....	<a href="#">2-7</a>
Module Indicators .....	<a href="#">2-8</a>
Chapter Summary .....	<a href="#">2-8</a>

<b>Module Programming</b> .....	<b><a href="#">3-1</a></b>
Chapter Objectives .....	<a href="#">3-1</a>
Block Transfer Programming .....	<a href="#">3-1</a>
Sample programs for FLEX I/O Analog Modules .....	<a href="#">3-2</a>
PLC-3 Programming .....	<a href="#">3-2</a>
Figure 3.1	
PLC-3 Family Sample Program Structure .....	<a href="#">3-2</a>
PLC-5 Programming .....	<a href="#">3-3</a>
Figure 3.2	
PLC-5 Family Sample Program Structure .....	<a href="#">3-3</a>
PLC-2 Programming .....	<a href="#">3-4</a>
Chapter Summary .....	<a href="#">3-4</a>
<b>Writing Configuration to and Reading Status from your Module with a Remote I/O Adapter</b> .....	<b><a href="#">4-1</a></b>
Chapter Objectives .....	<a href="#">4-1</a>
Configuring Your Thermocouple/mV Module .....	<a href="#">4-1</a>
Range Selection .....	<a href="#">4-2</a>
Input Scaling .....	<a href="#">4-2</a>
Hardware First Notch Filter .....	<a href="#">4-3</a>
Throughput in Normal Mode .....	<a href="#">4-3</a>
Reading Data From Your Module .....	<a href="#">4-4</a>
Mapping Data for the Analog Modules .....	<a href="#">4-4</a>
Thermocouple/mV Input Module (1794-IT8) Image Table Mapping .....	<a href="#">4-4</a>
Thermocouple/mV Input Module (1794-IT8) Read .....	<a href="#">4-4</a>
Thermocouple/mV Input Module (1794-IT8) Write .....	<a href="#">4-5</a>
Word/Bit Descriptions for the 1794-IT8 Thermocouple/mV Input Module .....	<a href="#">4-5</a>
Chapter Summary .....	<a href="#">4-7</a>
<b>How Communication Takes Place and I/O Image Table Mapping with the DeviceNet Adapter</b> .....	<b><a href="#">5-1</a></b>
Chapter Objectives .....	<a href="#">5-1</a>
About DeviceNet Manager .....	<a href="#">5-1</a>
Polled I/O Structure .....	<a href="#">5-1</a>
Adapter Input Status Word .....	<a href="#">5-2</a>
System Throughput .....	<a href="#">5-3</a>
Mapping Data into the Image Table .....	<a href="#">5-3</a>
Thermocouple/mV Input Module (1794-IT8) Image Table Mapping .....	<a href="#">5-3</a>
Thermocouple/mV Input Module (1794-IT8) Read .....	<a href="#">5-3</a>
Thermocouple/mV Input Module (1794-IT8) Write .....	<a href="#">5-4</a>
Word/Bit Descriptions for the 1794-IT8 Thermocouple/mV Input Module .....	<a href="#">5-4</a>
Defaults .....	<a href="#">5-7</a>

---

<b>Calibrating Your Module</b> .....	<b><u><a href="#">6-1</a></u></b>
Chapter Objective .....	<u><a href="#">6-1</a></u>
General Information .....	<u><a href="#">6-1</a></u>
Tools and Equipment .....	<u><a href="#">6-2</a></u>
Removing Lead Wire or Thermocouple Extension Wire Resistance .....	<u><a href="#">6-2</a></u>
Method 1 .....	<u><a href="#">6-2</a></u>
Method 2 .....	<u><a href="#">6-3</a></u>
Manually Calibrating your Thermocouple/mV Input Module .....	<u><a href="#">6-4</a></u>
Flow Chart for Calibration Procedure .....	<u><a href="#">6-5</a></u>
Calibration Setups .....	<u><a href="#">6-6</a></u>
Wiring Connections for the Thermocouple Module .....	<u><a href="#">6-6</a></u>
Read/Write Words for Calibration .....	<u><a href="#">6-7</a></u>
Offset Calibration .....	<u><a href="#">6-7</a></u>
Gain Calibration .....	<u><a href="#">6-8</a></u>
Calibrating Your Thermocouple/mV Module using DeviceNetManager Software (Cat. No. 1787-MGR) .....	<u><a href="#">6-9</a></u>
Offset Calibration .....	<u><a href="#">6-9</a></u>
Gain Calibration .....	<u><a href="#">6-11</a></u>
<b>Specifications</b> .....	<b><u><a href="#">A-1</a></u></b>
Derating Curve .....	<u><a href="#">A-2</a></u>
Resolution Curves for Thermocouples .....	<u><a href="#">A-3</a></u>
Type B Thermocouple .....	<u><a href="#">A-3</a></u>
Type E Thermocouple .....	<u><a href="#">A-3</a></u>
Type C Thermocouple .....	<u><a href="#">A-4</a></u>
Type J Thermocouple .....	<u><a href="#">A-4</a></u>
Type K Thermocouple .....	<u><a href="#">A-5</a></u>
Type R Thermocouple .....	<u><a href="#">A-5</a></u>
Type S Thermocouple .....	<u><a href="#">A-6</a></u>
Type T Thermocouple .....	<u><a href="#">A-6</a></u>
Type N Thermocouple .....	<u><a href="#">A-7</a></u>
Worst Case Accuracy for the Thermocouple/mV Module .....	<u><a href="#">A-7</a></u>
Error Due to Open Circuit Current Through Loop Resistance . . .	<u><a href="#">A-8</a></u>
Worst Case Repeatability for the Thermocouple/mV Input Module	<u><a href="#">A-8</a></u>

<b>Thermocouple Restrictions</b>	
<b>(Extracted from NBS Monograph 125 (ITS-68)) . . . . .</b>	<b><a href="#">B-1</a></b>
General . . . . .	<a href="#">B-1</a>
B (Platinum – 30% Rhodium vs Platinum – 6% Rhodium) Type Thermocouples . . . . .	<a href="#">B-1</a>
E (Nickel–Chromium vs Copper–Nickel <Constantan*>) Type Thermocouple . . . . .	<a href="#">B-2</a>
J (Iron vs Copper–Nickel <Constantan*>) Type Thermocouple . .	<a href="#">B-2</a>
K (Nickel–Chromium vs Nickel–Aluminum) Type Thermocouple .	<a href="#">B-4</a>
R (Platinum–13% Rhodium vs Platinum) and S (Platinum–10% Rhodium vs Platinum) Type Thermocouples	<a href="#">B-5</a>
T (Copper vs Copper–Nickel <Constantan*>) Type Thermocouple	<a href="#">B-5</a>
Support Services . . . . .	<a href="#">6-1</a>
Technical Support . . . . .	<a href="#">6-1</a>
Engineering and Field Services . . . . .	<a href="#">6-1</a>
Technical Training . . . . .	<a href="#">6-1</a>
Repair and Exchange Services . . . . .	<a href="#">6-1</a>

## Using This Manual

### Preface Objectives

Read this preface to familiarize yourself with this manual and to learn how to use it properly and efficiently.

### Audience

We assume that you have previously used an Allen-Bradley programmable controller, that you are familiar with its features, and that you are familiar with the terminology we use. If not, read the user manual for your processor before reading this manual.

In addition, if you are using this module in a DeviceNet system, you must be familiar with:

- DeviceNetManager™ Software, cat. no. 1787-MGR
- Microsoft Windows™

### Vocabulary

In this manual, we refer to:

- the individual thermocouple/mV module as the “module.”
- the programmable controller as the “controller” or the “processor.”



### What This Manual Contains

The contents of this manual are as follows:

Chapter	Title	What's Covered
1	Overview of Flex I/O and Your Thermocouple/mV Module	Describes features, capabilities, and hardware components.
2	How to Install Your Thermocouple/mV Input Module	Installation and connecting wiring
3	Module Programming	Block transfer programming and programming examples
4	Writing Configuration to and Reading Status from Your Module with a Remote I/O Adapter	Describes block transfer write and block transfer read configurations, including complete bit/word descriptions.
5	How Communication Takes Place and I/O Image Table Mapping with the DeviceNet Adapter	Describes communication over the I/O backplane between the module and the adapter, and how data is mapped into the image table.
6	Calibrating Your Module	Lists the tools needed, and the methods used to calibrate the thermocouple input module
<b>Appendix</b>		
A	Specifications	Module specifications, derating curve, resolution curves for thermocouples, worst case accuracy and error due to open circuit current.
B	Thermocouple Restrictions	Extracted from NBS Monograph 125 (IPTS-68)

## Conventions

We use these conventions in this manual:

In this manual, we show:	Like this:
that there is more information about a topic in another chapter in this manual	
that there is more information about the topic in another manual	

## For Additional Information

For additional information on FLEX I/O systems and modules, refer to the following documents:

Catalog Number	Description	Publications	
		Installation Instructions	User Manual
1787-MGR	DeviceNetManager Software User Manual		1787-6.5.3
	Industrial Automation Wiring and Grounding Guidelines	1770-4.1	
1794	1794 FLEX I/O Product Data	1794-2.1	
1794-ADN	DeviceNet Adapter	1794-5.14	1794-6.5.5
1794-ASB	Remote I/O Adapter	1794-5.11	1794-6.5.3

## Summary

This preface gave you information on how to use this manual efficiently. The next chapter introduces you to the remote I/O adapter module.



## Overview of FLEX I/O and your Thermocouple/mV Module

### Chapter Objectives

In this chapter, we tell you:

- what the FLEX I/O system is and what it contains
- how FLEX I/O modules communicate with programmable controllers
- the features of your thermocouple module

### The FLEX I/O System

FLEX I/O is a small, modular I/O system for distributed applications that performs all of the functions of rack-based I/O. The FLEX I/O system contains the following components shown below:

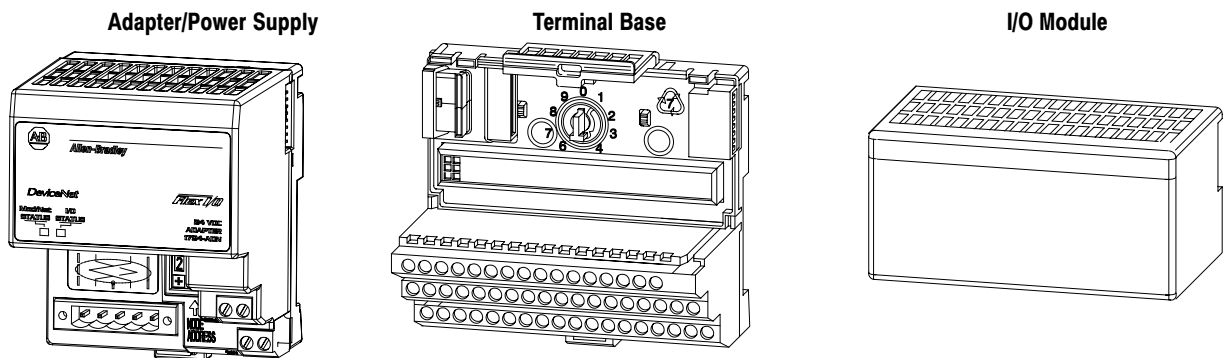

20125

- adapter/power supply – powers the internal logic for as many as eight I/O modules
- terminal base – contains a terminal strip to terminate wiring for thermocouple or millivolt inputs.
- I/O module – contains the bus interface and circuitry needed to perform specific functions related to your application

### How FLEX I/O Analog Modules Communicate with Programmable Controllers

FLEX I/O thermocouple/mV modules are block transfer modules that interface analog signals with any Allen-Bradley programmable controllers that have block transfer capability. Block transfer programming moves input or output data words between the module's memory and a designated area in the processor data table. Block transfer programming also moves configuration words from the processor data table to module memory.

# AB Parts

The adapter/power supply transfers data to the module (block transfer write) and from the module (block transfer read) using BTW and BTR instructions in your ladder diagram program. These instructions let the adapter obtain input or output values and status from the module, and let you establish the module's mode of operation. The illustration describes the communication process.

### Typical Communication Between an Adapter and a Module

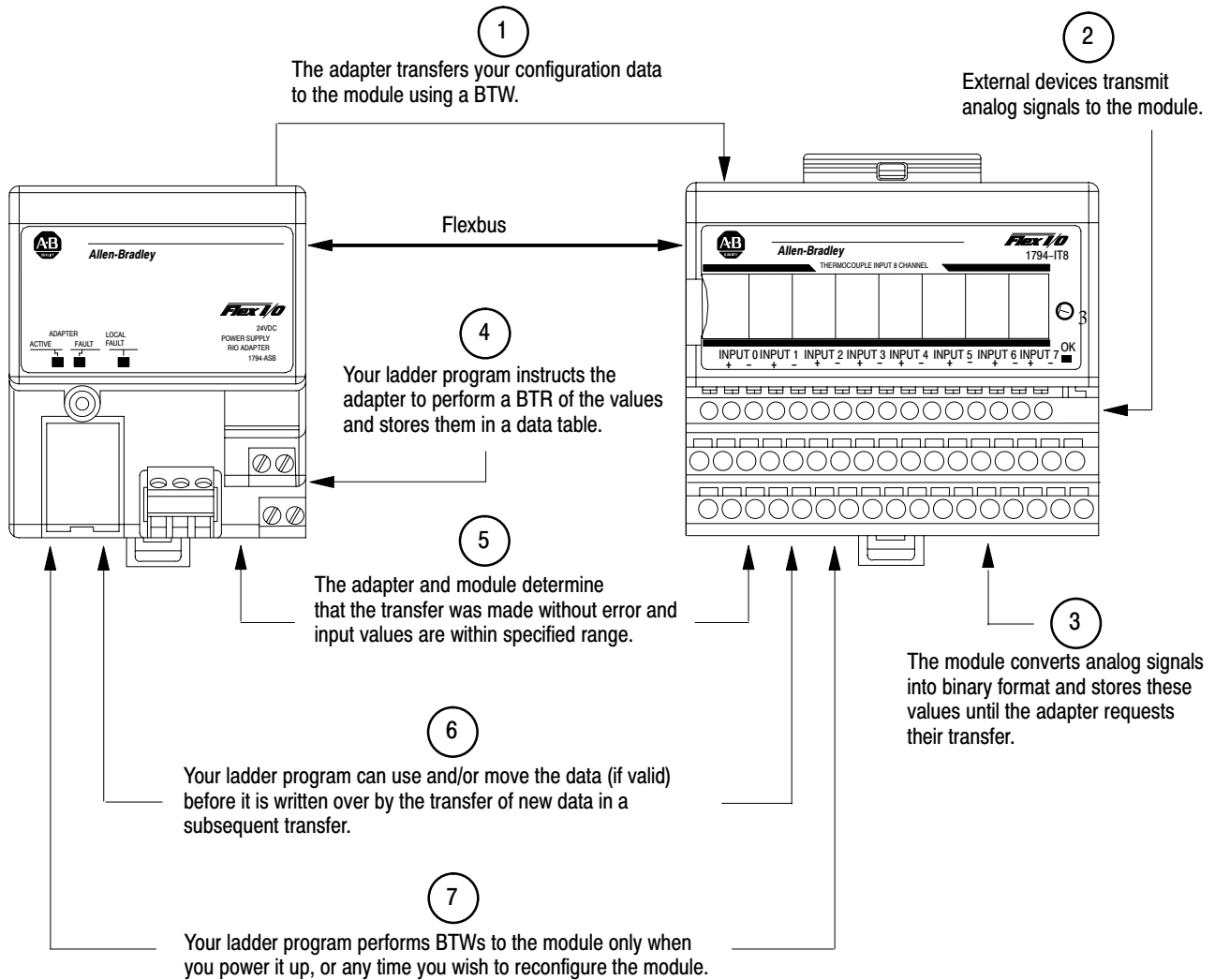

## Features of your Modules

The module label identifies the keyswitch position, wiring and module type. A removable label provides space for writing individual designations per your application.

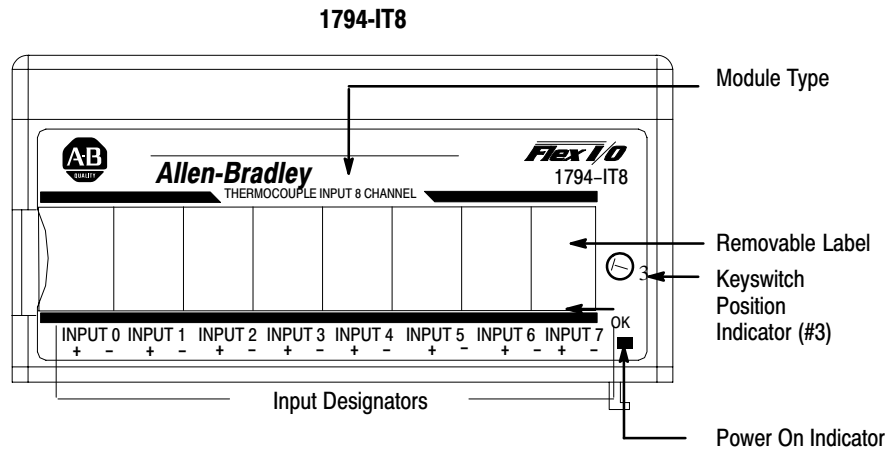

The thermocouple/mV module comes with 2 cold junction compensators. These are designed to mount in designated positions on the temperature terminal base unit (cat. no. 1794-TB3T). Refer to chapter 2 for installation instructions for the cold junction compensator assemblies.

## Chapter Summary

In this chapter, you learned about the FLEX I/O system and the thermocouple module, and how they communicate with programmable controllers.

## How to Install Your Thermocouple/mV Input Module

In this chapter, we tell you:

- how to install your module
- how to set the module keyswitch
- how to wire the terminal base
- about the indicators

### Before You Install Your Input Module

Before installing your thermocouple/mV module in the I/O chassis:

You need to:	As described under:
Calculate the power requirements of all modules in each chassis.	Power Requirements, page <a href="#">2-2</a>
Position the keyswitch on the terminal base	Installing the Module, page <a href="#">2-4</a>



**ATTENTION:** The Thermocouple module does not receive power from the backplane. +24V dc power must be applied to your module before installation. If power is not applied, the module position will appear to the adapter as an empty slot in your chassis.

### European Union Directive Compliance

If this product has the CE mark it is approved for installation within the European Union and EEA regions. It has been designed and tested to meet the following directives.

#### EMC Directive

This product is tested to meet Council Directive 89/336/EEC Electromagnetic Compatibility (EMC) and the following standards, in whole or in part, documented in a technical construction file:

- EN 50081-2EMC – Generic Emission Standard, Part 2 – Industrial Environment
- EN 50082-2EMC – Generic Immunity Standard, Part 2 – Industrial Environment

This product is intended for use in an industrial environment.

### Low Voltage Directive

This product is tested to meet Council Directive 73/23/EEC Low Voltage, by applying the safety requirements of EN 61131-2 Programmable Controllers, Part 2 – Equipment Requirements and Tests.

For specific information required by EN 61131-2, see the appropriate sections in this publication, as well as the following Allen-Bradley publications:

- Industrial Automation Wiring and Grounding Guidelines For Noise Immunity, publication 1770-4.1
- Guidelines for Handling Lithium Batteries, publication AG-5.4
- Automation Systems Catalog, publication B111

### Power Requirements

The wiring of the terminal base unit is determined by the current draw through the terminal base. Make certain that the current draw does not exceed 10A.



**ATTENTION:** Total current draw through the terminal base unit is limited to 10A. Separate power connections may be necessary.

---



**ATTENTION:** Do not daisy chain power or ground from the thermocouple terminal base unit to any ac or dc discrete module terminal base unit.

---

AB Parts

Methods of wiring the terminal base units are shown in the illustration below.

**Wiring the Terminal Base Units (1794-TB2 and -TB3 shown)**



**ATTENTION:** Do not daisy chain power or ground from the thermocouple terminal base unit to any ac or dc discrete module terminal base unit.

**Daisy-chaining**

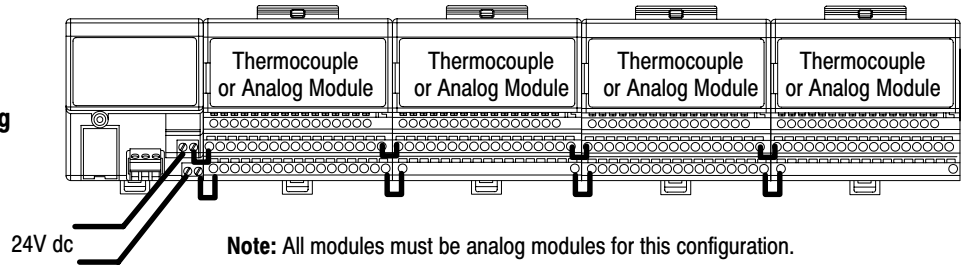

**Wiring when total current draw is less than 10A**

**Individual**

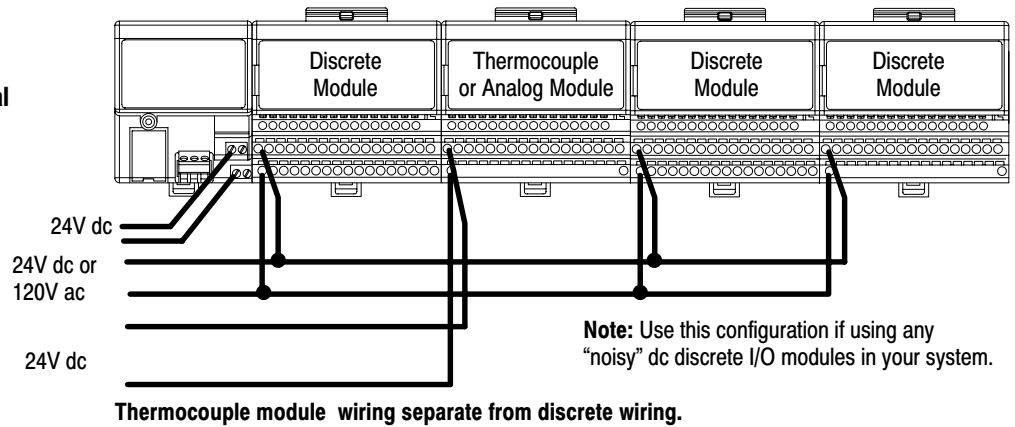

**Wiring when total current draw is greater than 10A**

**Combination**

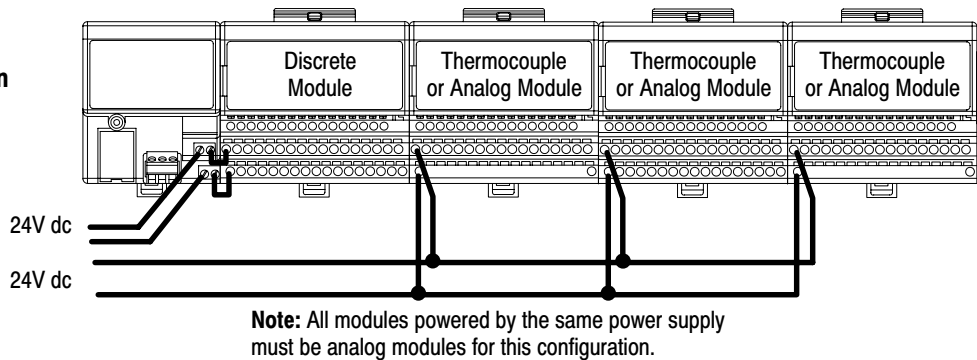

**Total current draw through any base unit must not be greater than 10A**

## Installing the Module

The thermocouple/mV module mounts on a 1794-TB2, -TB3 or -TB3T terminal base unit.

**Important:** You must use a 1794-TB3T terminal base unit if you are using the thermocouple/mV module for thermocouple inputs. You can use the 1794-TB2 or -TB3 terminal base for millivolt inputs only.

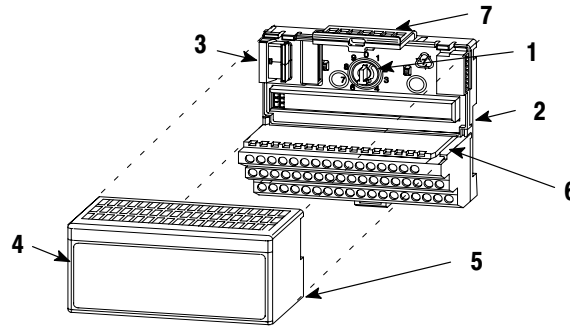

1. Rotate the keyswitch (1) on the terminal base unit (2) clockwise to position 3 as required for the thermocouple/mV module.
2. Make certain the flexbus connector (3) is pushed all the way to the left to connect with the neighboring terminal base/adaptor.  
**You cannot install the module unless the connector is fully extended.**



**ATTENTION:** Remove field-side power before removing or inserting the module. This module is designed so you **can remove and insert it under backplane power**. When you remove or insert a module with field-side power applied, an electrical arc may occur. An electrical arc can cause personal injury or property damage by:

- sending an erroneous signal to your system's field devices causing unintended machine motion
- causing an explosion in a hazardous environment

Repeated electrical arcing causes excessive wear to contacts on both the module and its mating connector. Worn contacts may create electrical resistance.

3. Before installing the module, check to make sure that the pins on the bottom of the module are straight so they will align properly with the female connector in the base unit.
4. Position the module (4) with its alignment bar (5) aligned with the groove (6) on the terminal base.
5. Press firmly and evenly to seat the module in the terminal base unit. The module is seated when the latching mechanism (7) is locked into the module.
6. Repeat the above steps to install the next module in its terminal base unit.

## Connecting Wiring for the Thermocouple/mV Module

Thermocouple/mV module wiring is made through the terminal base unit on which the module mounts. The module comes with 2 cold junction compensators for use when using the thermocouple module in the thermocouple mode.

Compatible terminal base unit are:

Module	1794-TB2	1794-TB3	1794-TB3T <sup>1</sup>
1794-IT8	Yes <sup>2</sup>	Yes <sup>2</sup>	Yes

<sup>1</sup> The 1794-TB3T terminal base unit contains connections for cold junction compensation for use with thermocouple modules.

<sup>2</sup> For millivolt inputs only.

1794-TB2 and 1794-TB3

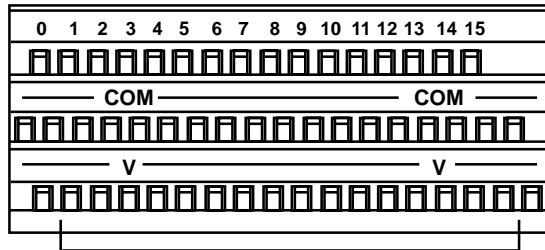

V = 24V dc      These terminals on 1794-TB3 only.  
COM = 24V dc common

1794-TB3T

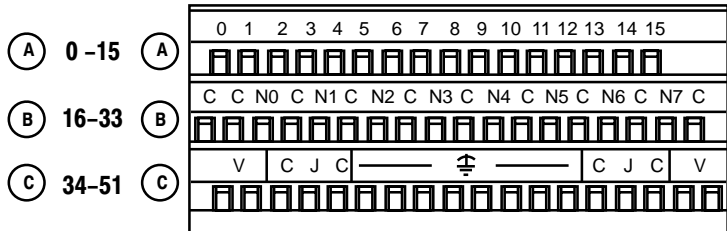

Where: V = 24V dc      N = additional input  
C = 24V dc common      ⊕ = chassis ground  
CJC = cold junction compensation

### Connecting Wiring using a 1794-TB2, -TB3 and -TB3T Terminal Base Units

1. Connect the individual signal wiring to numbered terminals on the **0-15** row (A) on the terminal base unit. Connect the high side (+) to the even numbered terminals, and the low side (-) to the odd numbered terminals. See Table 2.A.
2. Connect shield return to the associated terminal on row **B**, as shown in Table 2.A.
  - On 1794-TB2 and -TB3 bases only: terminate shields to the associated shield return terminals on row (B).
  - On 1794-TB3T bases only: terminate shields to terminals 39 to 46 on row C.
3. Connect +24V dc to terminal 34 on the **34-51** row (C), and 24V common to terminal 16 on the **B** row.

**Important:** To reduce susceptibility to noise, power analog modules and discrete modules from separate power supplies.



**ATTENTION:** Do not daisy chain power or ground from the thermocouple terminal base unit to any ac or dc discrete module terminal base unit.





**ATTENTION:** The Thermocouple/mV module does not receive power from the backplane. +24V dc power must be applied to your module before installation. If power is not applied, the module position will appear to the adapter as an empty slot in your chassis.

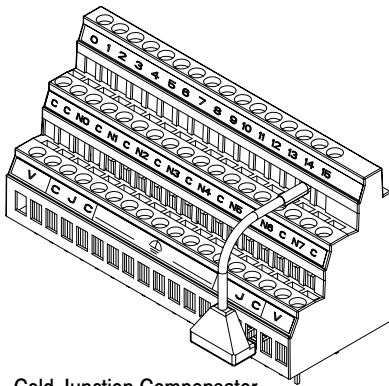

Cold Junction Compensator  
Pt.No. 969424-01

- On 1794-TB3T terminal base units: Connect the cold junction compensation (CJC) wiring to terminals 36, 37 and 38 for inputs 0 through 3, and terminals 47, 48 and 49 for inputs 4 through 7.

Connect the tail of the cold junction compensator to any of the associated thermocouple input terminals: 0 through 7 for CJC connected to 36, 37 and 38; or 8 through 15 for CJC connected to 47, 48 and 49. **The tail of the cold junction compensator shares a terminal with an input.**

- If daisy chaining the +24V dc power to the next base unit, connect a jumper from terminal 51 on this base unit to terminal 34 on the next base unit.

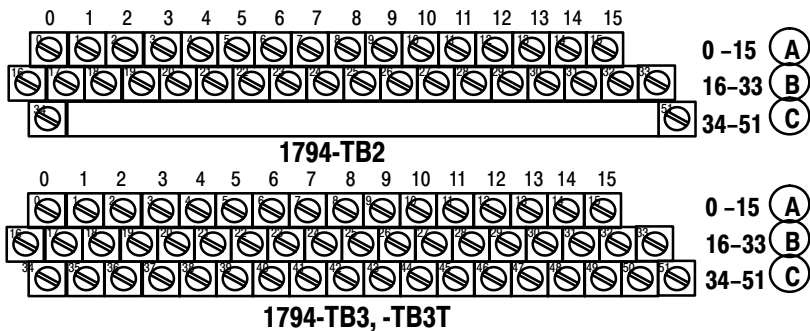

**Table 2.A**  
Wiring connections for the 1794-IT8 Thermocouple Input Module

Thermocouple Channel	1794-TB2, -TB3 Terminal Base Units			1794-TB3T Terminal Base Unit <sup>2</sup>		
	High Signal Terminal (+)	Low Signal Terminal (-)	Shield Return	High Signal Terminal (+)	Low Signal Terminal (-)	Shield Return <sup>1</sup>
0	0	1	17	0	1	39
1	2	3	19	2	3	40
2	4	5	21	4	5	41
3	6	7	23	6	7	42
4	8	9	25	8	9	43
5	10	11	27	10	11	44
6	12	13	29	12	13	45
7	14	15	31	14	15	46
24V dc Common	16 thru 33			16, 17, 19, 21, 23, 25, 27, 29, 31 and 33		
+24V dc power	1794-TB2 - 34 and 51; 1794-TB3 - 34 thru 51			34, 35, 50 and 51		

<sup>1</sup> Terminals 39 to 46 are chassis ground.  
<sup>2</sup> Terminals 36, 37, 38 and 47, 48, 49 are cold junction compensator terminals.





**ATTENTION:** The thermocouple/mV modules do not receive power from the backplane. +24V dc power must be applied to your module before operation. If power is not applied, the module position will appear to the adapter as an empty slot in your chassis. If the adapter does not recognize your module after installation is completed, cycle power to the adapter.



**ATTENTION:** Total current draw through the terminal base unit is limited to 10A. Separate power connections to the terminal base unit may be necessary.

**Example of Millivolt Input Wiring to a 1794-TB3 Terminal Base Unit**

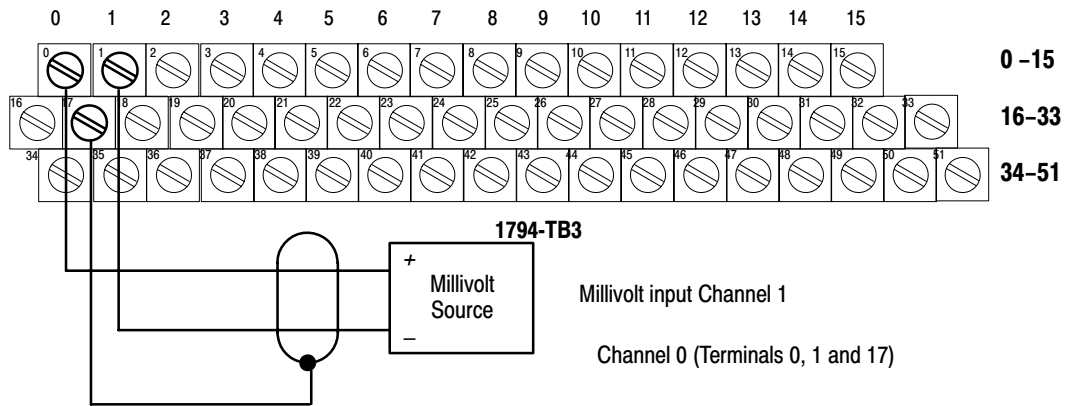

**Example of 3-wire Thermocouple Wiring to a 1794-TB3T Temperature Terminal Base Unit**

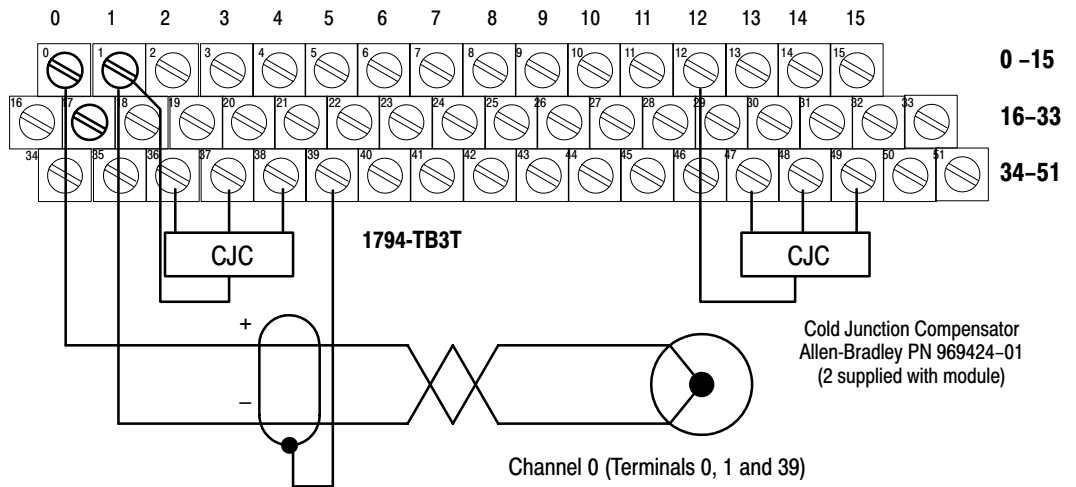

## Module Indicators

The thermocouple/mV module has one status indicator that is on when power is applied to the module. This indicator has 3 different states:

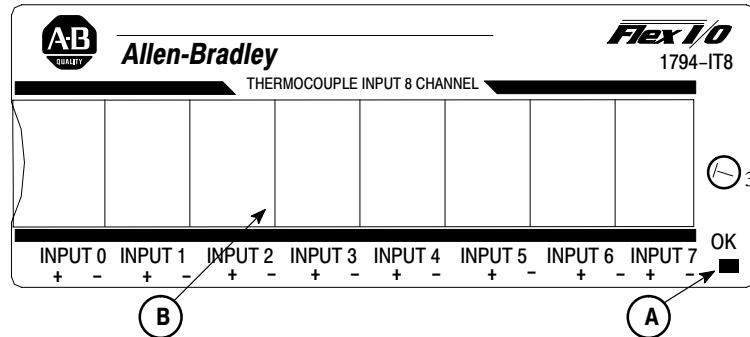

**A** = Status Indicator - indicates diagnostic results and configuration status

**B** = Insertable label for writing individual input designations

Color	State	Meaning
Red	On	Indicates a critical fault (diagnostic failure, etc.)
	Blinking	Indicates a noncritical fault (such as open sensor, input out of range, etc.)
Green	On	Module is configured and fully operational
	Blinking	Module is functional but not configured
	Off	Module not powered

## Chapter Summary

In this chapter, you learned how to install your thermocouple/mV module in an existing programmable controller system and how to wire to the terminal base units.

# AB Parts

## Module Programming

### Chapter Objectives

In this chapter, we tell you about:

- block transfer programming
- sample programs for the PLC-3 and PLC-5 processors

### Block Transfer Programming

Your thermocouple/mV module communicates with the processor through bidirectional block transfers. This is the sequential operation of both read and write block transfer instructions.

A configuration block transfer write (BTW) is initiated when the thermocouple module is first powered up, and subsequently only when the programmer wants to enable or disable features of the module. The configuration BTW sets the bits which enable the programmable features of the module, such as scaling, alarms, ranges, etc. Block transfer reads are performed to retrieve information from the module.

Block transfer read (BTR) programming moves status and data from the module to the processor's data table. The processor user program initiates the request to transfer data from the module to the processor. The transferred words contain module status, channel status and input data from the module.



**ATTENTION:** If the thermocouple/mV module is not powered up before the remote I/O adapter, the adapter will not recognize the module. Make certain that the thermocouple/mV module is installed and powered before or simultaneously with the remote I/O adapter. If the adapter does not establish communication with the module, cycle power to the adapter.

---

The following sample programs are minimum programs; all rungs and conditioning must be included in your application program. You can disable BTRs, or add interlocks to prevent writes if desired. Do not eliminate any storage bits or interlocks included in the sample programs. If interlocks are removed, the program may not work properly.

Your program should monitor status bits and block transfer read activity.

## Sample programs for FLEX I/O Analog Modules

The following sample programs show you how to use your analog module efficiently when operating with a programmable controller.

These programs show you how to:

- configure the module
- read data from the module

These example programs illustrate the minimum programming required for communication to take place.

### PLC-3 Programming

Block transfer instructions with the PLC-3 processor use one binary file in a data table section for module location and other related data. This is the block transfer control file. The block transfer data file stores data that you want transferred to your module (when programming a block transfer write) or from your module (when programming a block transfer read). The address of the block transfer data files are stored in the block transfer control file.

**The same block transfer control file is used for both the read and write instructions for your module.** A different block transfer control file is required for every module.

A sample program segment with block transfer instructions is shown in Figure 3.1, and described below.

**Figure 3.1**  
**PLC-3 Family Sample Program Structure**

#### Program Action

At power-up in RUN mode, or when the processor is switched from PROG to RUN, the user program enables a block transfer read. Then it initiates a block transfer write to configure the module.

Thereafter, the program continuously performs read block transfers.

Note: You must create the data file for the block transfers before you enter the block transfer instructions.

The pushbutton allows the user to manually request a block transfer write.

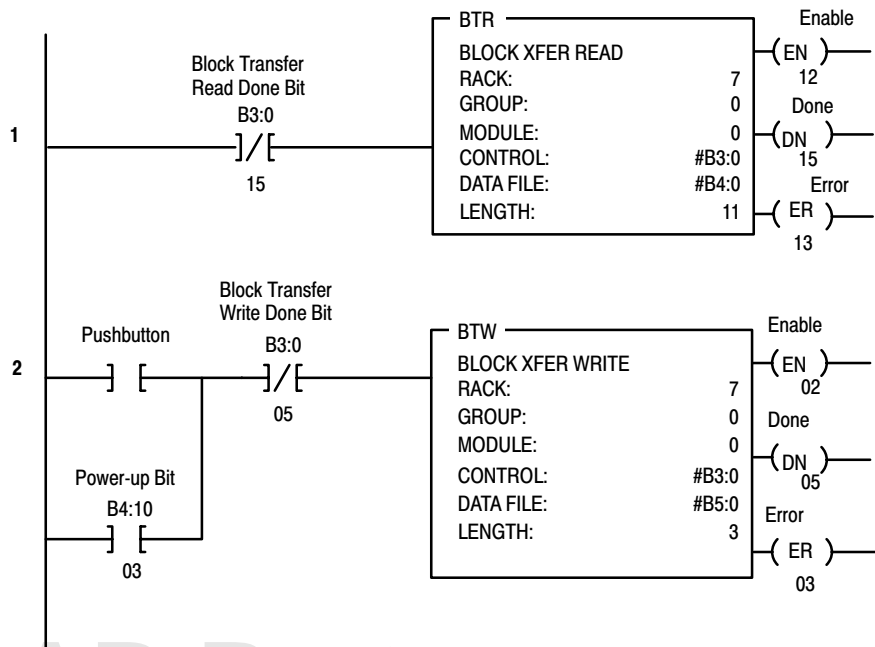

AB Parts

## PLC-5 Programming

The PLC-5 program is very similar to the PLC-3 program with the following exceptions:

1. Block transfer enable bits are used instead of done bits as the conditions on each rung.
2. Separate block transfer control files are used for the block transfer instructions.

**Figure 3.2**  
PLC-5 Family Sample Program Structure

### Program Action

At power-up in RUN mode, or when the processor is switched from PROG to RUN, the user program enables a block transfer read. Then it initiates a block transfer write to configure the module.

Thereafter, the program continuously performs read block transfers.

The pushbutton allows the user to manually request a block transfer write.

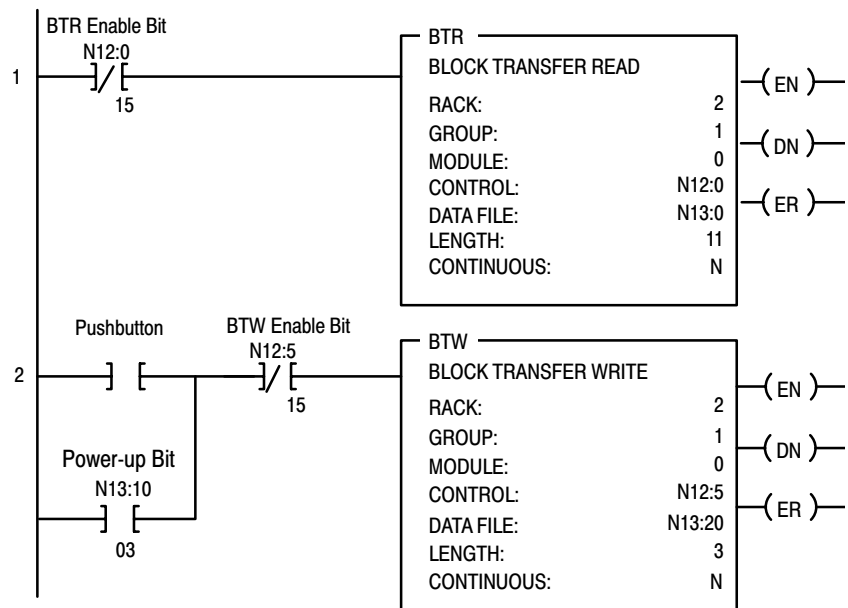

## **PLC-2 Programming**

The 1794 analog I/O modules are not recommended for use with PLC-2 family programmable controllers due to the number of digits needed for high resolution.

## **Chapter Summary**

In this chapter, you learned how to program your programmable controller. You were given sample programs for your PLC-3 and PLC-5 family processors.

# AB Parts

## Writing Configuration to and Reading Status from your Module with a Remote I/O Adapter

### Chapter Objectives

In this chapter, we tell you about:

- configuring your module's features
- entering your data
- reading data from your module
- the read block format

### Configuring Your Thermocouple/mV Module

Because of the wide variety of possible configurations, you must configure your module to conform to the specific application that you have chosen. The module is configured using a group of data table words that are transferred to the module using a block transfer write instruction.

The software configurable features available for the thermocouple module are:

- input/output range selection, including full range and bipolar
- selectable first notch filter
- data reported in °F, °C, unipolar or bipolar count

**Note:** PLC-5 family programmable controllers that use 6200 software (version 5.2 or later) programming tools can take advantage of the IOCONFIG utility to configure these modules. IOCONFIG uses menu-based screens for configuration without having to set individual bits in particular locations. Refer to your 6200 software literature for details.



## Range Selection

Individual input channels are configurable to operate with the following sensor types:

Sensor Type		Range
Voltage	Millivolt	-76.50 to +76.50mV
Thermocouple	Type B	300 to 1800°C
	Type E	-270 to 1000°C
	Type J	-210 to 1200°C
	Type K	-270 to 1372°C
	Type R	-50 to 1768°C
	Type S	-50 to 1768°C
	Type T	-270 to 400°C
	Type N	-270 to 1300°C
	Type C	0 to 2315°C

You select individual channel ranges using write words 1 and 2 of the block transfer write instruction.

## Input Scaling

Scaling lets you report each channel in actual engineering units. Scaled values are in integer format.

Input Type	Range	Scaling	Maximum Resolution
Millivolt	-76.50 to +76.50mV	-7650 to +7650	10 $\mu$ V
Type B	300 to 1800°C	3000 to 18000	0.1°C
Type E	-270 to 1000°C	2700 to 10000	0.1°C
Type J	-210 to 1200°C	-2100 to 12000	0.1°C
Type K	-270 to 1372°C	-2700 to 13720	0.1°C
Type R	-50 to 1768°C	-500 to 17680	0.1°C
Type S	-50 to 1768°C	-500 to 17680	0.1°C
Type T	-270 to 400°C	-2700 to 4000	0.1°C
Type N	-270 to 1300°C	-2700 to 13000	0.1°C
Type C	0 to 2315°C	0 to 23150	0.1°C
Type B	572 to 3272°F	5720 to 32720	0.1°F
Type E	-454 to 1832°F	-4540 to 18320	0.1°F
Type J	-346 to 2192°F	-3460 to 21920	0.1°F
Type K	-454 to 2502°F	-4540 to 25020	0.1°F
Type R	-58 to 3214°F	-580 to 32140	0.1°F
Type S	-58 to 3214°F	-580 to 32140	0.1°F
Type T	-454 to 752°F	-4540 to 7520	0.1°F
Type N	-450 to 2372°F	-4500 to 23720	0.1°F
Type C	32 to 4199°F	320 to 41990	0.1°F

**Note:** In thermocouple mode, scaled number has an implied decimal point 1 digit from the right. For example, if reading is 18000, temperature is 1800.0. In millivolt mode, the implied decimal point is to the left of the last 2 digits. For example, if reading is 2250, actual reading is 22.50mV

You select input scaling using the designated words of the write block transfer instruction. Refer to the Bit/Word description for write word 0, bits 00 and 01.

## Hardware First Notch Filter

A hardware filter in the analog to digital converter lets you select a frequency for the first notch of the filter. Selection of the filter influences the analog to digital output data rate and changes the module throughput. Module throughput is a function of the number of inputs used and the first notch filter. Both of these influence the time from a thermocouple input to arrival at the backplane.

### Throughput in Normal Mode

A/D Filter First Notch Frequency (effective resolution)	10Hz (16-bits)	25Hz (16-bits)	50Hz (16-bits)	60Hz (16-bits)	100Hz (16-bits)	250Hz (13-bits)	500Hz (11-bits)	1000Hz (9-bits)
Number of channels scanned	System Throughput (in ms and s)							
1	325	145	85	75	55	37	31	28
2	650	290	170	150	110	74	62	56
3	975	435	255	225	165	111	93	84
4	1.3s	580	340	300	220	148	124	112
5	1.625s	725	425	375	275	185	155	140
6	1.95s	870	510	450	330	222	186	168
7	2.275s	1.015s	595	525	385	259	217	196
8	2.60s <sup>1</sup>	1.16s	680	600	440	296	248	224

<sup>1</sup> Default setting

## Reading Data From Your Module

Read programming moves status and data from the thermocouple input module to the processor's data table. The processor's user program initiates the request to transfer data from the thermocouple/mV input module to the processor.

## Mapping Data for the Analog Modules

The following read and write words and bit/word descriptions describe the information written to and read from the thermocouple/mV input module. The module uses up to 11 words of input image and up to 4 words of output image. Each word is composed of 16 bits.

### Thermocouple/mV Input Module (1794-IT8) Image Table Mapping

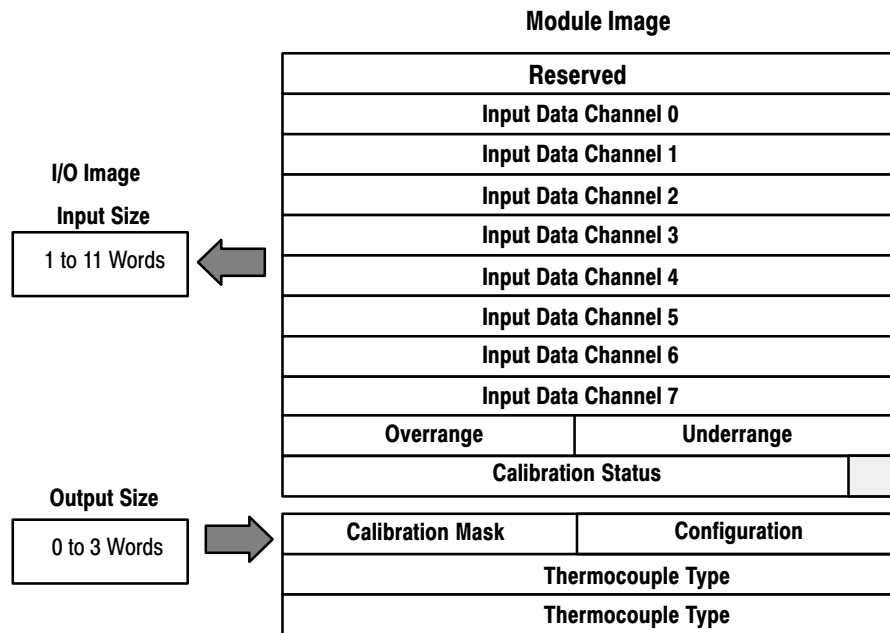

### Thermocouple/mV Input Module (1794-IT8) Read

Decimal Bit	15	14	13	12	11	10	09	08	07	06	05	04	03	02	01	00
Octal Bit	17	16	15	14	13	12	11	10	07	06	05	04	03	02	01	00
Read Word 0	Reserved															
1	Channel 0 Input Data															
2	Channel 1 Input Data															
3	Channel 2 Input Data															
4	Channel 3 Input Data															
5	Channel 4 Input Data															
6	Channel 5 Input Data															
7	Channel 6 Input Data															
8	Channel 7 Input Data															

Decimal Bit	15	14	13	12	11	10	09	08	07	06	05	04	03	02	01	00
Octal Bit	17	16	15	14	13	12	11	10	07	06	05	04	03	02	01	00
9	Overrange Bits							Underrange Bits								
10	0	0	0	0	0	Bad Cal	Cal Done	Cal Range	0	Diagnostic Status			Pwr Up	Bad Structure	CJC over	CJC Under

### Thermocouple/mV Input Module (1794-IT8) Write

Dec. Bit	15	14	13	12	11	10	09	08	07	06	05	04	03	02	01	00
Octal Bit	17	16	15	14	13	12	11	10	07	06	05	04	03	02	01	00
Write Word 0	8-Bit Calibration Mask							Cal Clk	Cal hi Cal lo	Filter Cutoff			fdf	Data Type		
1	Thermocouple 3 Type			Thermocouple 2 Type			Thermocouple 1 Type			Thermocouple 0 Type						
2	Thermocouple 7 Type			Thermocouple 6 Type			Thermocouple 5 Type			Thermocouple 4 Type						

Where: fdf = fixed digital filter bit

### Word/Bit Descriptions for the 1794-IT8 Thermocouple/mV Input Module

Word	Decimal Bit (Octal Bit)	Description
Read Word 0	00-15 (00-17)	Reserved
Read Word 1	00-15 (00-17)	Channel 0 Input data
Read Word 2	00-15 (00-17)	Channel 1 Input data
Read Word 3	00-15 (00-17)	Channel 2 Input data
Read Word 4	00-15 (00-17)	Channel 3 Input data
Read Word 5	00-15 (00-17)	Channel 4 Input data
Read Word 6	00-15 (00-17)	Channel 5 Input data
Read Word 7	00-15 (00-17)	Channel 6 Input data
Read Word 8	00-15 (00-17)	Channel 7 Input data
Read Word 9	00-07 (00-07)	<b>Underrange bits</b> – these bits are set if the input signal is below the input channel's minimum range.
	08-15 (10-17)	<b>Overrange bits</b> – these bits are set if 1), the input signal is above the input channel's maximum range, or 2), an open detector is detected.
Read Word 10	00 (00)	Cold Junction sensor underrange bit. – this bit is set if the cold junction temperature is below 0°C.
	01 (01)	Cold Junction sensor overrange bit. – this bit is set if the cold junction temperature is above 70°C.
	02 (02)	<b>Bad Structure</b> – this bit is set if an invalid thermocouple type is selected.
	03 (03)	<b>Powerup bit</b> – this bit is set (1) until configuration data is received by the module.
	04-06 (04-06)	<b>Critical Error bits</b> – If these bits are anything other than all zeroes, return the module to the factory for repair
	07 (07)	Unused – set to 0
	08 (10)	<b>Calibration Range bit</b> – set to 1 if a reference signal is out of range during calibration
	09 (11)	<b>Calibration Done bit</b> – set to 1 after an initiated calibration cycle is complete.
10 (12)	<b>Calibration Bad bit</b> – set to 1 if the channel has not had a valid calibration.	
11-15 (13-17)	Unused – set to 0	

Word	Decimal Bit (Octal Bit)	Description				
Write Word 0	00-01 (00-01)	<b>Module Data Type</b>				
		<b>Bit</b>	<b>01</b>	<b>00</b>	<b>Definition</b>	
			0	0	°C (default)	
			0	1	°F	
			1	0	Bipolar counts scaled between -32768 and +32767	
			1	1	Unipolar counts scaled between 0 and 65535	
	Bit 02 (02)	<b>Fixed Digital Filter</b> - When this bit is set (1), a software digital filter is enabled. This filter settles to 100% of a Full Scale step input in 60 times the selected first notch filter time shown on page 4-3. (Default - filter disabled.)				
	03-05 (03-05)	<b>A/D Filter First Notch Frequency</b>				
		<b>Bit</b>	<b>05</b>	<b>04</b>	<b>03</b>	<b>Definition</b>
			0	0	0	10Hz (default)
			0	0	1	25Hz
			0	1	0	50Hz
			0	1	1	60Hz
			1	0	0	100Hz
			1	0	1	250Hz
			1	1	0	500Hz
			1	1	1	1000hZ
	06 (06)	Calibration High/Low bit - This bit is set during gain calibration; reset during offset calibration.				
	07 (07)	Calibration clock - this bit must be set to 1 to prepare for a calibration cycle; then reset to 0 to initiate calibration.				
	08-15 (10-17)	Calibration mask - The channel, or channels, to be calibrated will have the correct mask bit set. Bit 8 corresponds to channel 0, bit 9 to channel 1, and so on.				

Word	Decimal Bit (Octal Bit)	Description					
Write Word 1	00-03 (00-03)	Channel 0 Thermocouple Type					
		<b>Bit</b>	<b>03</b>	<b>02</b>	<b>01</b>	<b>00</b>	<b>Thermocouple Type - Range</b>
		0	0	0	0	0	Millivolts (default)
		0	0	0	1	0	B 300 to 1800°C (572 to 3272°F)
		0	0	1	0	0	E -270 to 1000°C (-454 to 1832°F)
		0	0	1	1	1	J -210 to 1200°C (-346 to 2192°F)
		0	1	0	0	0	K -71 to 1372°C (-95 to 2502°F)
		0	1	0	1	1	R -50 to 1768°C (-58 to 3214°F)
		0	1	1	0	0	S -50 to 1768°C (-58 to 3214°F)
		0	1	1	1	1	T -73 to 400°C (-99 to 752°F)
		1	0	0	0	0	C 0 to 2315°C (32 to 4199°F)
		1	0	0	1	1	N -270 to 1300°C (-450 to 2372°F)
		1	0	1	0	0	Reserved
		1	0	1	1	1	Reserved
		1	1	0	0	0	Module reports cold junction temperature for channels 00-03
		1	1	0	1	1	Module reports cold junction temperature for channels 04-07
		1	1	1	0	0	Reserved
	1	1	1	1	1	No sensor connected (do not scan)	
	04-07 (04-07)	Channel 1 Thermocouple Type (see bits 00-03)					
	08-11 (10-13)	Channel 2 Thermocouple Type (see bits 00-03)					
	12-15 (14-17)	Channel 3 Thermocouple Type (see bits 00-03)					
Write Word 2	00-03 (00-03)	Channel 4 Thermocouple Type (see write word 1, bits 00-03)					
	04-07 (04-07)	Channel 5 Thermocouple Type (see write word 1, bits 00-03)					
	08-11 (10-13)	Channel 6 Thermocouple Type (see write word 1, bits 00-03)					
	12-15 (14-17)	Channel 7 Thermocouple Type (see write word 1, bits 00-03)					

## Chapter Summary

In this chapter, you learned how to configure your module's features and enter your data.

# How Communication Takes Place and I/O Image Table Mapping with the DeviceNet Adapter

## Chapter Objectives

In this chapter, we tell you about:

- DeviceNetManager software
- I/O structure
- image table mapping
- factory defaults

## About DeviceNet Manager

DeviceNetManager software is a software tool used to configure your Flex I/O DeviceNet adapter and its related modules. This software tool can be connected to the adapter via the DeviceNet network.

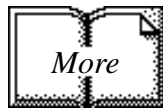

You must know and understand how DeviceNet Manager works in order to add a device to the network. Refer to the DeviceNetManager Software User Manual, publication 1787-6.5.3, and the DeviceNet Adapter Module User Manual, publication 1794-6.5.5.

## Polled I/O Structure

Output data is received by the adapter in the order of the installed I/O modules. The Output data for Slot 0 is received first, followed by the Output data for Slot 1, and so on up to slot 7.

The first word of input data sent by the adapter is the Adapter Status Word. This is followed by the input data from each slot, in the order of the installed I/O modules. The Input data from Slot 0 is first after the status word, followed by Input data from Slot 2, and so on up to slot 7.

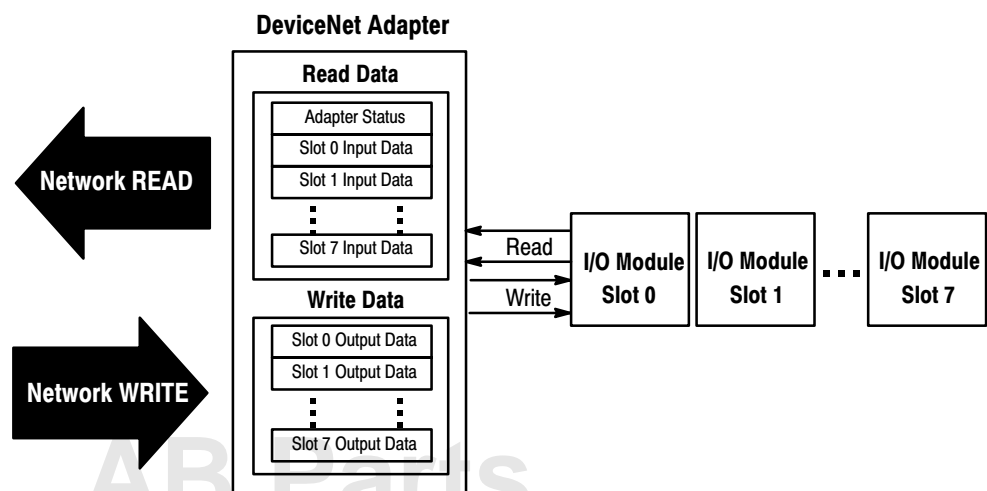

## Adapter Input Status Word

The input status word consists of:

- I/O module fault bits – 1 status bit for each slot
- node address changed – 1 bit
- I/O status – 1 bit

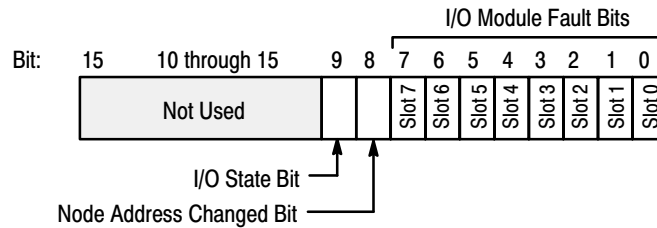

The adapter input status word bit descriptions are shown in the following table.

Bit Description	Bit	Explanation
I/O Module Fault	0	This bit is set (1) when an error is detected in slot position 0.
	1	This bit is set (1) when an error is detected in slot position 1.
	2	This bit is set (1) when an error is detected in slot position 2.
	3	This bit is set (1) when an error is detected in slot position 3.
	4	This bit is set (1) when an error is detected in slot position 4.
	5	This bit is set (1) when an error is detected in slot position 5.
	6	This bit is set (1) when an error is detected in slot position 6.
	7	This bit is set (1) when an error is detected in slot position 7.
Node Address Changed	8	This bit is set (1) when the node address switch setting has been changed since power up.
I/O State	9	Bit = 0 - idle Bit = 1 - run
	10 thru 15	Not used - sent as zeroes.

Possible causes for an **I/O Module Fault** are:

- transmission errors on the Flex I/O backplane
- a failed module
- a module removed from its terminal base
- incorrect module inserted in a slot position
- the slot is empty

The **node address changed** bit is set when the node address switch setting has been changed since power up. The new node address does not take effect until the adapter has been powered down and then powered back up.



## System Throughput



System throughput, from analog input to backplane, is a function of:

- the configured A/D filter first notch frequency
- the number of channels actually configured for connection to a specific sensor

The A/D converter which converts channel 0 through 7 analog data to a digital word provides a programmable first notch filter. You can set the position of the first notch of this filter during module configuration. The selection influences the A/D output data rate, thus affecting system throughput.

The number of channels included in each input scan also affects system throughput.

## Mapping Data into the Image Table

FLEX I/O thermocouple module data table mapping is shown below.

### Thermocouple/mV Input Module (1794-IT8) Image Table Mapping

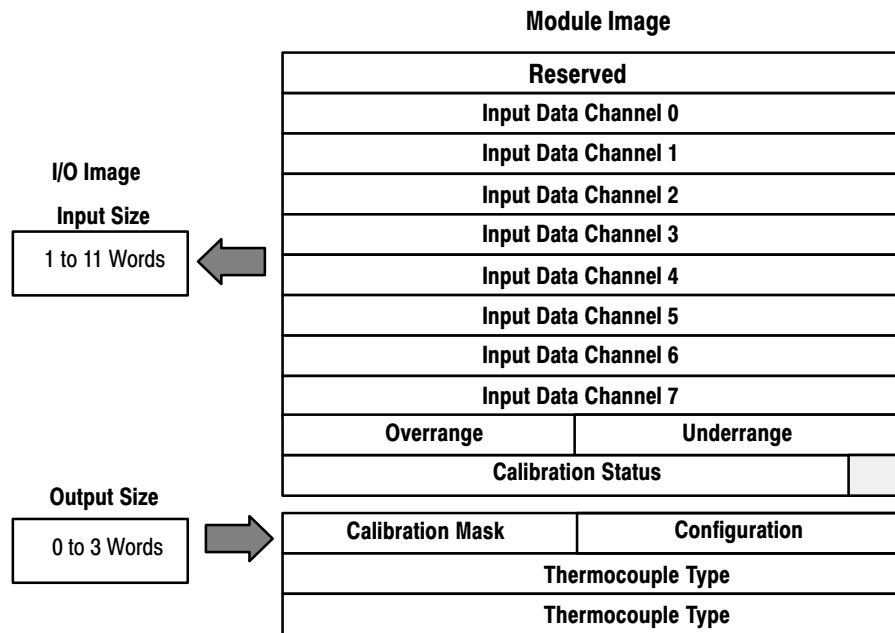

### Thermocouple/mV Input Module (1794-IT8) Read

Dec. Bit	15	14	13	12	11	10	09	08	07	06	05	04	03	02	01	00
Octal Bit	17	16	15	14	13	12	11	10	07	06	05	04	03	02	01	00
Read Word 1	Reserved															
Read Word 2	Channel 0 Input Data															
Read Word 3	Channel 1 Input Data															
Read Word 4	Channel 2 Input Data															
Read Word 5	Channel 3 Input Data															
Read Word 6	Channel 4 Input Data															

Dec. Bit	15	14	13	12	11	10	09	08	07	06	05	04	03	02	01	00
Octal Bit	17	16	15	14	13	12	11	10	07	06	05	04	03	02	01	00
Read Word 7	Channel 5 Input Data															
Read Word 8	Channel 6 Input Data															
Read Word 9	Channel 7 Input Data															
Read Word 10	Overrange Bits								Underrange Bits							
Read Word 11	0	0	0	0	0	Bad Cal	Cal Done	Cal Range	0	Diagnostics	Pwr Up	Bad Structure	CJC over	CJC Under		

### Thermocouple/mV Input Module (1794-IT8) Write

Dec. Bit	15	14	13	12	11	10	09	08	07	06	05	04	03	02	01	00
Octal Bit	17	16	15	14	13	12	11	10	07	06	05	04	03	02	01	00
Write Word 1	8-Bit Calibration Mask								Cal Clk	Cal hi Cal lo	Filter Cutoff			FDf	Data Type	
Write Word 2	Thermocouple 3 Type				Thermocouple 2 Type				Thermocouple 1 Type				Thermocouple 0 Type			
Write Word 3	Thermocouple 7 Type				Thermocouple 6 Type				Thermocouple 5 Type				Thermocouple 4 Type			

Where: FDF = fixed digital filter bit

### Word/Bit Descriptions for the 1794-IT8 Thermocouple/mV Input Module

Word	Decimal Bit (Octal Bit)	Description
Read Word 1	00-15 (00-17)	Reserved
Read Word 2	00-15 (00-17)	Channel 0 Input data
Read Word 3	00-15 (00-17)	Channel 1 Input data
Read Word 4	00-15 (00-17)	Channel 2 Input data
Read Word 5	00-15 (00-17)	Channel 3 Input data
Read Word 6	00-15 (00-17)	Channel 4 Input data
Read Word 7	00-15 (00-17)	Channel 5 Input data
Read Word 8	00-15 (00-17)	Channel 6 Input data
Read Word 9	00-15 (00-17)	Channel 7 Input data
Read Word 10	00-07 (00-07)	<b>Underrange bits</b> - these bits are set if the input signal is below the input channel's minimum range.
	08-15 (10-17)	<b>Overrange bits</b> - these bits are set if 1), the input signal is above the input channel's maximum range, or 2), an open detector is detected.
Read Word 11	00 (00)	Cold Junction sensor underrange bit. - this bit is set if the cold junction temperature is below 0°C.
	01 (01)	Cold Junction sensor overrange bit. - this bit is set if the cold junction temperature is above 70°C.
	02 (02)	<b>Bad Structure</b> - this bit is set if there is an invalid thermocouple type selected.

Word	Decimal Bit (Octal Bit)	Description																																														
Read Word 11 continued	03 (03)	<b>Powerup bit</b> – this bit is set (1) until configuration data is received by the module.																																														
	04-06 (04-06)	<b>Critical Fault bits</b> – If these bits are anything other than zero, return the module to the factory for repair.																																														
	07 (07)	Unused – set to 0																																														
	08 (10)	<b>Calibration Range bit</b> – set to 1 if a reference signal is out of range during calibration																																														
	09 (11)	<b>Calibration Done bit</b> – set to 1 after an initiated calibration cycle is complete.																																														
	10 (12)	<b>Calibration Bad bit</b> – set to 1 if the channel has not had a valid calibration.																																														
	11-15 (13-17)	Unused – set to 0																																														
Write Word 1	00-01 (00-01)	<b>Module Data Type</b>																																														
		<table border="1"> <thead> <tr> <th>Bit</th> <th>01</th> <th>00</th> <th>Definition</th> </tr> </thead> <tbody> <tr> <td></td> <td>0</td> <td>0</td> <td>°C (default)</td> </tr> <tr> <td></td> <td>0</td> <td>1</td> <td>°F</td> </tr> <tr> <td></td> <td>1</td> <td>0</td> <td>Bipolar counts scaled between -32768 and +32767</td> </tr> <tr> <td></td> <td>1</td> <td>1</td> <td>Unipolar counts scaled between 0 and 65535</td> </tr> </tbody> </table>	Bit	01	00	Definition		0	0	°C (default)		0	1	°F		1	0	Bipolar counts scaled between -32768 and +32767		1	1	Unipolar counts scaled between 0 and 65535																										
	Bit	01	00	Definition																																												
		0	0	°C (default)																																												
		0	1	°F																																												
		1	0	Bipolar counts scaled between -32768 and +32767																																												
		1	1	Unipolar counts scaled between 0 and 65535																																												
	Bit 02 (02)	<b>Fixed Digital Filter</b> – When this bit is set (1), a software digital filter is enabled. This filter settles to 100% of a Full Scale step input in 60 times the selected first notch filter time shown on page 4-3. <b>Default – filter disabled.</b>																																														
	03-05 (03-05)	<b>A/D Filter First Notch Frequency</b>																																														
		<table border="1"> <thead> <tr> <th>Bit</th> <th>05</th> <th>04</th> <th>03</th> <th>Definition</th> </tr> </thead> <tbody> <tr> <td></td> <td>0</td> <td>0</td> <td>0</td> <td>10Hz (default)</td> </tr> <tr> <td></td> <td>0</td> <td>0</td> <td>1</td> <td>25Hz</td> </tr> <tr> <td></td> <td>0</td> <td>1</td> <td>0</td> <td>50Hz</td> </tr> <tr> <td></td> <td>0</td> <td>1</td> <td>1</td> <td>60Hz</td> </tr> <tr> <td></td> <td>1</td> <td>0</td> <td>0</td> <td>100Hz</td> </tr> <tr> <td></td> <td>1</td> <td>0</td> <td>1</td> <td>250Hz</td> </tr> <tr> <td></td> <td>1</td> <td>1</td> <td>0</td> <td>500Hz</td> </tr> <tr> <td></td> <td>1</td> <td>1</td> <td>1</td> <td>1000hZ</td> </tr> </tbody> </table>	Bit	05	04	03	Definition		0	0	0	10Hz (default)		0	0	1	25Hz		0	1	0	50Hz		0	1	1	60Hz		1	0	0	100Hz		1	0	1	250Hz		1	1	0	500Hz		1	1	1	1000hZ	
	Bit	05	04	03	Definition																																											
		0	0	0	10Hz (default)																																											
		0	0	1	25Hz																																											
		0	1	0	50Hz																																											
		0	1	1	60Hz																																											
		1	0	0	100Hz																																											
		1	0	1	250Hz																																											
		1	1	0	500Hz																																											
		1	1	1	1000hZ																																											
	06 (06)	<b>Calibration High/Low bit</b> – This bit is set during gain calibration; reset during offset calibration.																																														
	07 (07)	<b>Calibration clock</b> – this bit must be set to 1 to prepare for a calibration cycle; then reset to 0 to initiate calibration.																																														
	08-15 (10-17)	<b>Calibration mask</b> – The channel, or channels, to be calibrated will have the correct mask bit set. Bit 8 corresponds to channel 0, bit 9 to channel 1, and so on.																																														

Word	Decimal Bit (Octal Bit)	Description					
Write Word 2	00-03 (00-03)	Channel 0 Thermocouple Type					
		<b>Bit</b>	<b>03</b>	<b>02</b>	<b>01</b>	<b>00</b>	<b>Thermocouple Type - Range</b>
			0	0	0	0	Millivolts (default)
			0	0	0	1	B 300 to 1800°C (572 to 3272°F)
			0	0	1	0	E -270 to 1000°C (-454 to 1832°F)
			0	0	1	1	J -210 to 1200°C (-346 to 2192°F)
			0	1	0	0	K -71 to 1372°C (-95 to 2502°F)
			0	1	0	1	R -50 to 1768°C (-58 to 3214°F)
			0	1	1	0	S -50 to 1768°C (-58 to 3214°F)
			0	1	1	1	T -73 to 400°C (-99 to 752°F)
			1	0	0	0	C 0 to 2315°C (32 to 4199°F)
			1	0	0	1	N -270 to 1300°C (-450 to 2372°F)
			1	0	1	0	Reserved
			1	0	1	1	Reserved
			1	1	0	0	Module reports cold junction temperature for channels 00-03
			1	1	0	1	Module reports cold junction temperature for channels 04-07
			1	1	1	0	Reserved
		1	1	1	1	No sensor connected (do not scan)	
	04-07 (04-07)	Channel 1 Thermocouple Type (see bits 00-03)					
	08-11 (10-13)	Channel 2 Thermocouple Type (see bits 00-03)					
	12-15 (14-17)	Channel 3 Thermocouple Type (see bits 00-03)					
Write Word 3	00-03 (00-03)	Channel 4 Thermocouple Type (see write word 2, bits 00-03)					
	04-07 (04-07)	Channel 5 Thermocouple Type (see write word 2, bits 00-03)					
	08-11 (10-13)	Channel 6 Thermocouple Type (see write word 2, bits 00-03)					
	12-15 (14-17)	Channel 7 Thermocouple Type (see write word 2, bits 00-03)					

## Defaults

Each I/O module has default values associated with it. At default, each module will generate inputs/status and expect outputs/configuration.

Module Defaults for:		Factory Defaults		Real Time Size	
Catalog Number	Description	Input Default	Output Default	Input Default	Output Default
1794-IT8	8 Thermocouple Input	11	4	10	0

**Factory defaults** are the values assigned by the adapter when you:

- first power up the system, and
- no previous stored settings have been applied.

For analog modules, the defaults reflect the actual number of input words/output words. For example, for the 8 thermocouple input analog module, you have 11 input words, and 4 output words.

You can change the I/O data size for a module by reducing the number of words mapped into the adapter module, as shown in “real time sizes.”

**Real time sizes** are the settings that provide optimal real time data to the adapter module.

Analog modules have 15 words assigned to them. This is divided into input words/output words. You can reduce the I/O data size to fewer words to increase data transfer over the backplane. For example, an 8 thermocouple input module has 11 words input/4 words output with factory default. You can reduce the write words to 0, thus eliminating the configuration setting and unused words. And you can reduce the read words to 10 by eliminating the calibration status words.

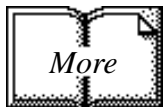

For information on using DeviceNetManager software to configure your adapter, refer to the DeviceNetManager Software User Manual, publication 1787-6.5.3.

## Calibrating Your Module

### Chapter Objective

In this chapter we tell you:

- what tools are needed to calibrate
- how to calibrate out lead wire resistance
- calibrate your module manually
- calibrate your module using DeviceNetManager software

### General Information

**Your module is shipped to you already calibrated.** If a calibration check is required, follow the procedure below.

Perform module calibration periodically, based on your application.

Module calibration may also be required to remove module error due to aging of components

In addition, calibration may be required to eliminate long lead wire resistance to open circuit detection current. See “Error Due to Open Circuit Current Through Loop Resistance” in Appendix A.

Calibration can be accomplished using any of the following methods:

- manual calibration, as described below.
- 6200 I/O CONFIGURATION software (version 5.2 or later)— refer to your 6200 software publications for procedures for calibrating.
- DeviceNetManager Software – refer to your DeviceNetManager software documentation for the DeviceNet Adapter Module, Cat. No. 1794-ADN. Some portion of this calibration is included here for use by personnel proficient with DeviceNet Adapter configuration software.

**Important:** You can use a 1794-TB2 or -TB3 terminal base unit if you are using the thermocouple/mV module in the millivolt mode only. You **must** use a 1794-TB3T terminal base unit for all thermocouple uses.

## Tools and Equipment

In order to calibrate your thermocouple input module you will need the following tools and equipment:

Tool or Equipment	Description		
Precision Voltage Source or Thermocouple Simulator and Calibration source	0-100mV, 1µV resolution	Analogic 3100, Data Precision 8200 or equivalent	
		Thermocouple Simulator/Calibrator Model 1120	Ectron Corporation 8159 Engineer Road San Diego, CA 92111-1980
Industrial Terminal and Interconnect Cable	Programming terminal for A-B family processors		

## Removing Lead Wire or Thermocouple Extension Wire Resistance

The thermocouple/mV module has open circuit detection. This is accomplished by a 1mA current source in the module. This current flowing through the lead wire or thermocouple extension wire generates an error or offset voltage in the reading.

Calibrate this error out using one of the following methods.

### Method 1

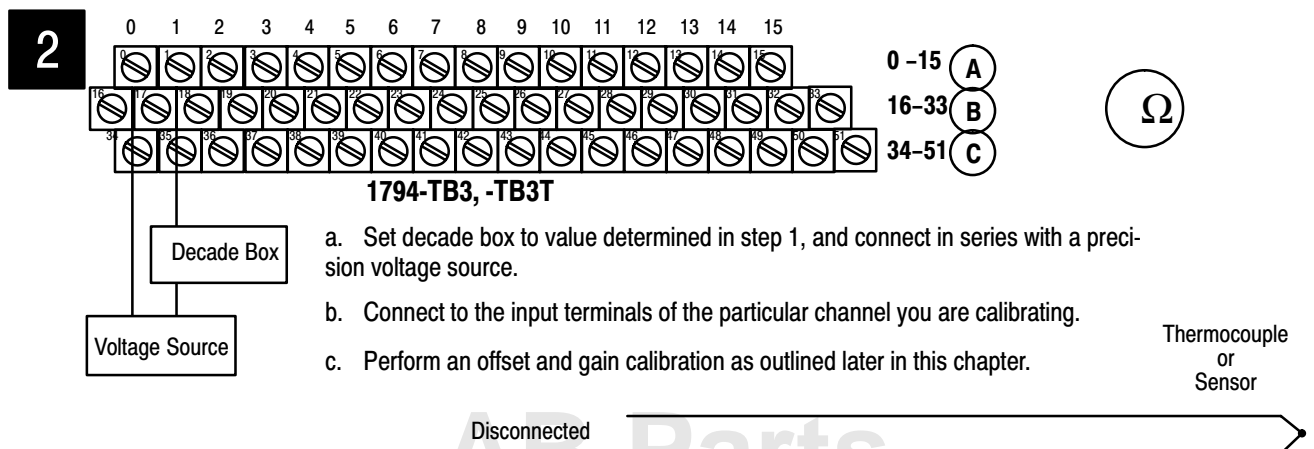
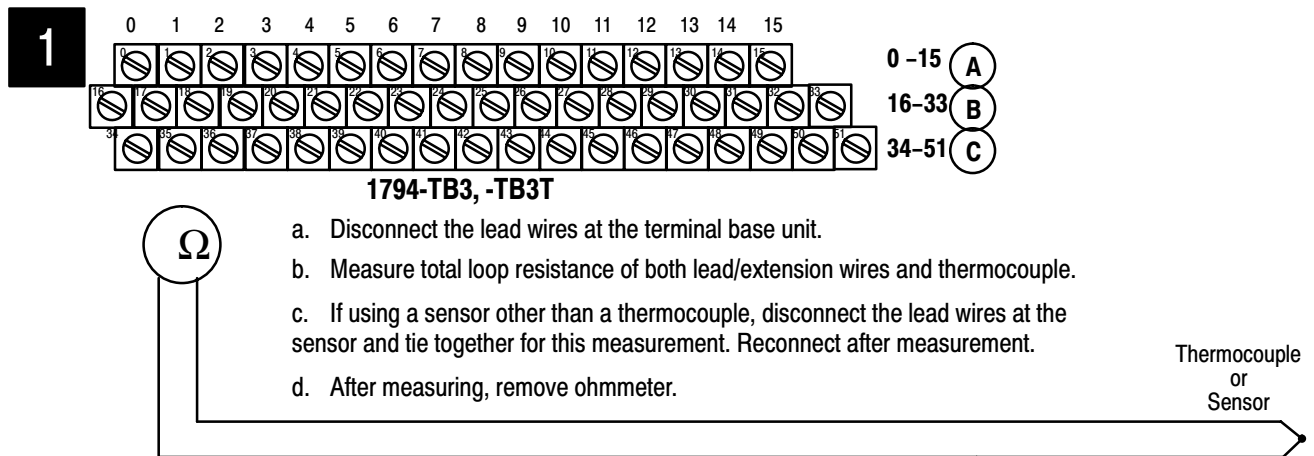

AB Parts

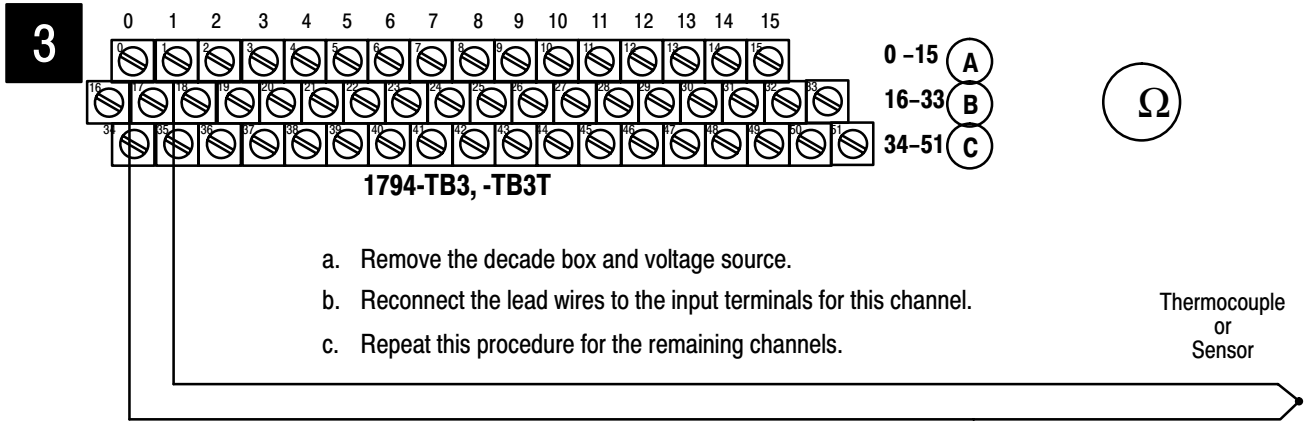

**Method 2**

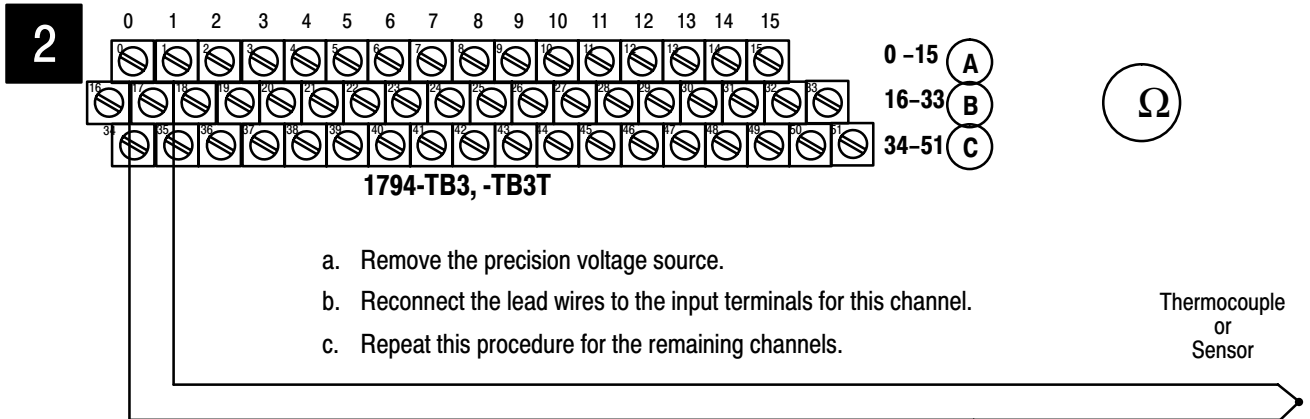
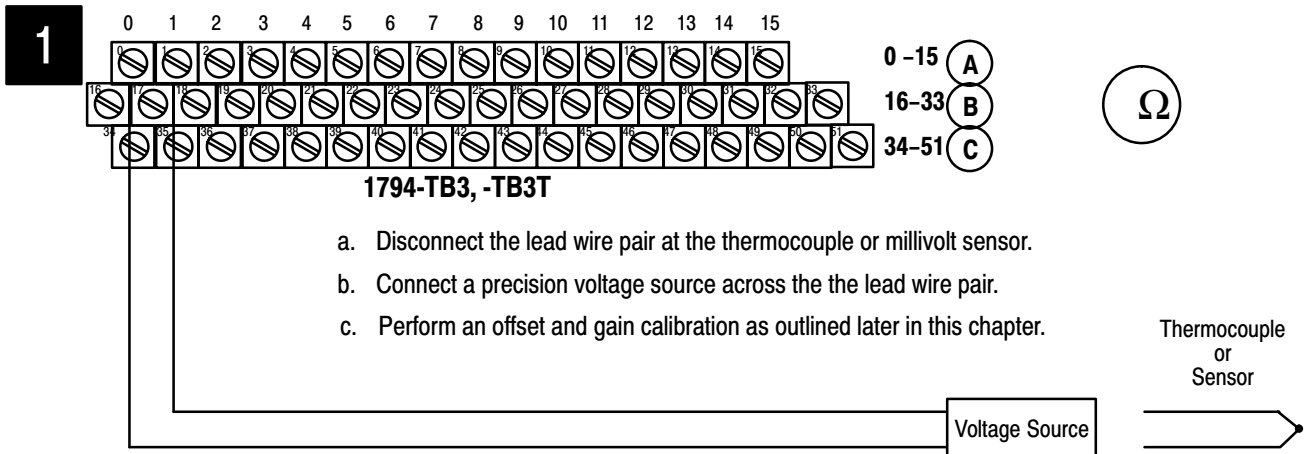



## Manually Calibrating your Thermocouple/mV Input Module

You must calibrate the module in a FLEX I/O system. The module must communicate with the processor and a programming terminal. You can calibrate input channels in any order, or all at once.

Before calibrating your module, you must enter ladder logic into the processor memory, so that you can initiate BTWs to the module, and read inputs from the module.

**Important:** In order to allow the internal module temperature to stabilize, energize the module for at least 40 minutes before calibrating.

Module calibration consists of:

- Applying a reference to the desired input(s).
- Sending a message to the module indicating which inputs to read and what calibration step is being performed (offset).

The module stores this input data.

- Applying a second reference signal to the module, and sending a second message indicating which inputs to read and what calibration step is being performed (gain).

The module computes new calibration values for the inputs.

Once the calibration is complete, the module reports back status information about the procedure.

The following flow chart shows the procedure for calibration

**Important:** Perform the offset calibration procedure first, then the gain calibration procedure.

# AB Parts

**Flow Chart for Calibration Procedure**

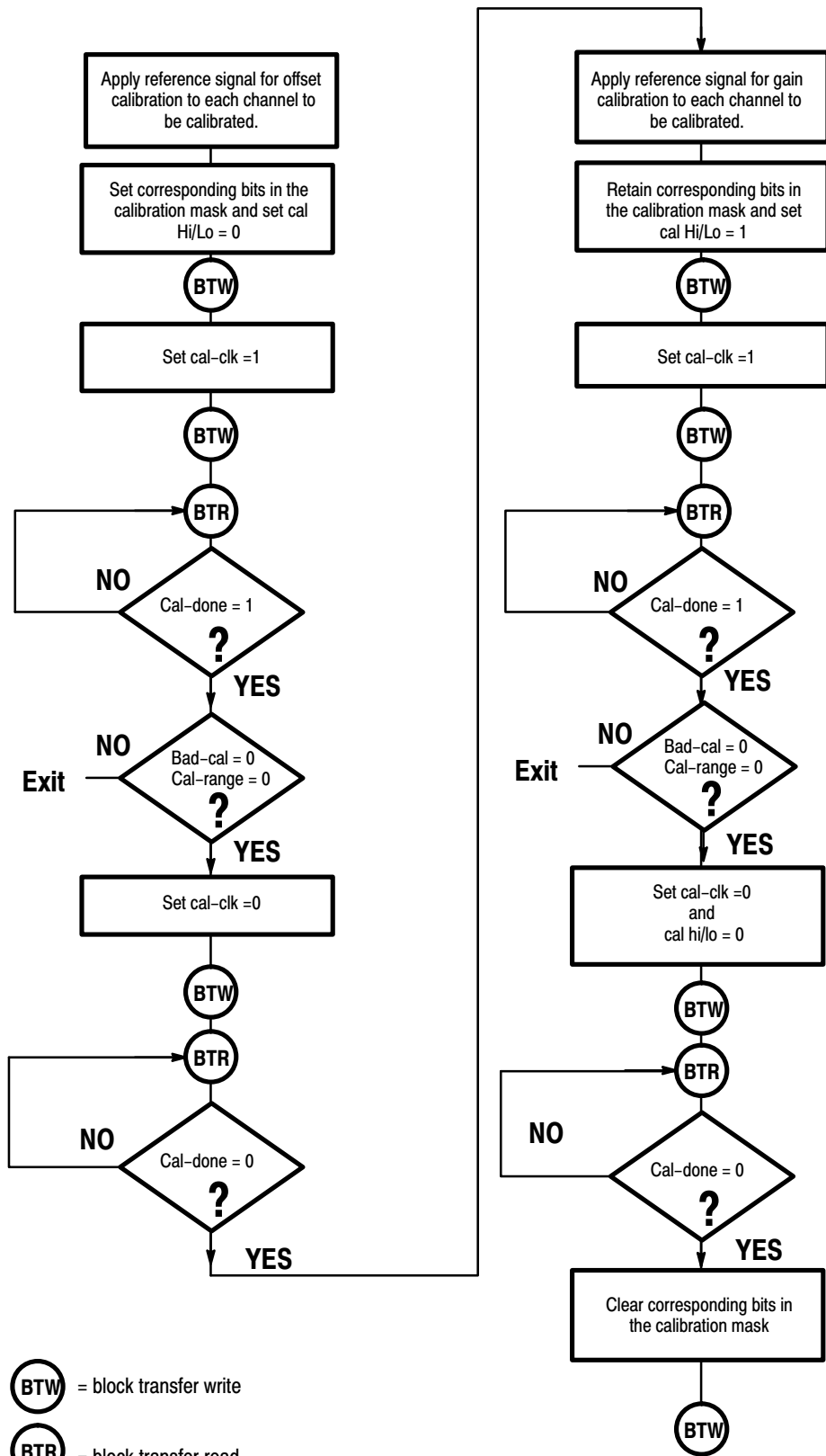

### Calibration Setups

#### Using a Precision Voltage Source

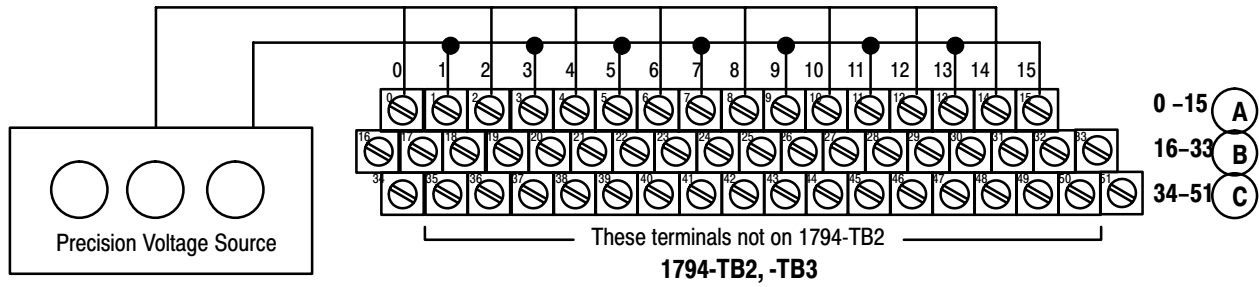

**Note:** Use 1794-TB2 and -TB3 terminal base units for millivolt inputs only.

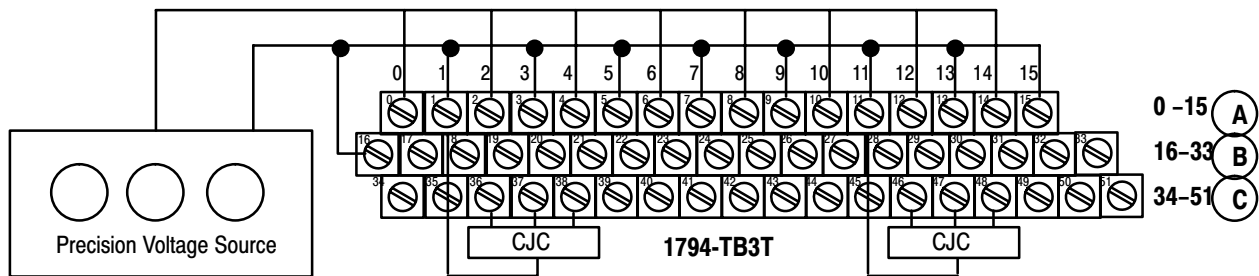

**Note 2:** CJC not required if using thermocouple for resistance only.

### Wiring Connections for the Thermocouple Module

Thermocouple Channel	1794-TB2, -TB3 Terminal Base Units			1794-TB3T Terminal Base Unit <sup>2</sup>		
	High Signal Terminal (+)	Low Signal Terminal (-)	Shield Return	High Signal Terminal (+)	Low Signal Terminal (-)	Shield Return <sup>1</sup>
0	0	1	17	0	1	39
1	2	3	19	2	3	40
2	4	5	21	4	5	41
3	6	7	23	6	7	42
4	8	9	25	8	9	43
5	10	11	27	10	11	44
6	12	13	29	12	13	45
7	14	15	31	14	15	46
24V dc Common	16 thru 33			16, 17, 19, 21, 23, 25, 27, 29, 31 and 33		
+24V dc power	1794-TB2 - 34 and 51; 1794-TB3 - 34 thru 51			34, 35, 50 and 51		

<sup>1</sup> Terminals 39 to 46 are chassis ground.  
<sup>2</sup> Terminals 36, 37, 38 and 47, 48, 49 are cold junction compensator connections.

### Read/Write Words for Calibration

Dec. Bit	15	14	13	12	11	10	09	08	07	06	05	04	03	02	01	00
Octal Bit	17	16	15	14	13	12	11	10	07	06	05	04	03	02	01	00
Read Word 10	0	0	0	0	0	Bad Cal	Cal Done	Cal Range	0	Diagnostic Status			Pwr Up	Bad Struct	CJC over	CJC Under
Write Word 0	8-Bit Calibration Mask								Cal Clk	Cal hi Cal lo	Filter Cutoff		FDf	Data Type		

### Offset Calibration

Inputs can be calibrated one at a time or all at once. To calibrate the offsets for all inputs at once, proceed as follows:

1. Apply power to the module for 40 minutes before calibrating.
2. Connect 0.000V across each input channel. Connect all high signal terminals together and attach to the positive lead from the precision voltage source. Connect all low signal terminals together and attach to the negative lead.
3. After the connections stabilize, use a block transfer write to set the bit(s) in the calibration mask that correspond to the channel(s) you want to calibrate to 1. (Bits 08 through 15 in write word 0.)
4. Send another block transfer write to set the cal-clk bit (07 in write word 0) to 1.
5. Monitor the cal-done bit (09 in read word 10). If the calibration is successful, the cal-done bit will be set to 1. Verify that the bad-cal bit (10 in read word 10) and the cal-range bit (08 in read word 10) are not set (0).
6. Send another block transfer write to set the cal-clk bit (07 in write word 0) to 0.
7. Monitor the cal-done bit (09 in read word 10). The cal-done bit will be reset to 0.
8. If the calibration is successful, proceed to the gain calibration.

## Gain Calibration

After completing the offset calibration, proceed with the gain calibration.

1. Apply power to the module for 40 minutes before calibrating.
2. Connect 75.000mV across each input channel. Connect all high signal terminals together and attach to the positive lead from the precision voltage source. Connect all low signal terminals together and attach to the negative lead.
3. After the connections stabilize, send a block transfer write to the module to set the bit in the calibration mask that corresponds to the channel to be calibrated to 1, and the hi/lo bit (bit 06 in write word 0) to 1. (Set bits 08 through 15 in write word 0 if calibrating all inputs at one time.)
4. Send another block transfer write to set the cal-clk bit (07 in write word 0) to 1.
5. Monitor the cal-done bit (09 in read word 10). If the calibration is successful, the cal-done bit will be set to 1. Verify that the bad-cal bit (10 in read word 10) and the cal-range bit (08 in read word 10) are not set (0).
6. Send another BTW to set the cal-clk bit (07 in write word 0) to 0.
7. Send another BTW to set the hi/lo bit (bit 06 in write word 0) to 0.
8. Monitor the cal-done bit (09 in read word 10). The cal-done bit will be reset to 0.
9. If individually calibrating channels, repeat steps 1 through 7 for offset calibration on any additional channels you want to calibrate.
10. Send a block transfer write to the module to clear all calibration mask bits to 0.

# AB Parts

# Calibrating Your Thermocouple/mV Module using DeviceNetManager Software (Cat. No. 1787-MGR)

The following procedure assumes that you are using DeviceNetManager software (cat. no. 1787-MGR) and have the thermocouple/mV module installed in a working system.

## Offset Calibration

Inputs can be calibrated one at a time or all at once. To calibrate the offsets for all inputs at once, proceed as follows:

1. Connect 0.000V across each input channel. Connect all high signal terminals together and attach to the positive lead from the precision voltage source. Connect all low signal terminals together and attach to the negative lead.
2. Apply power to the module for 45 minutes before calibrating.
3. Click on Configure for the slot containing the thermocouple module.

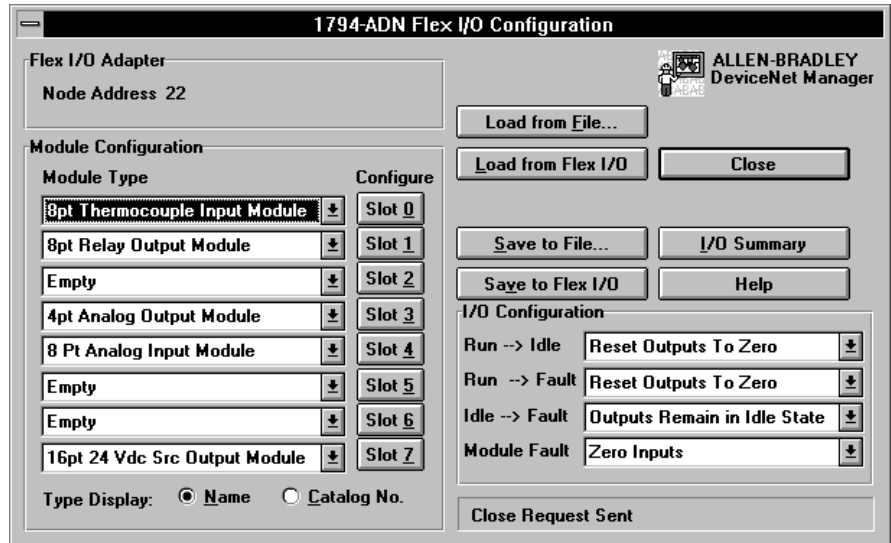

The following screen appears:

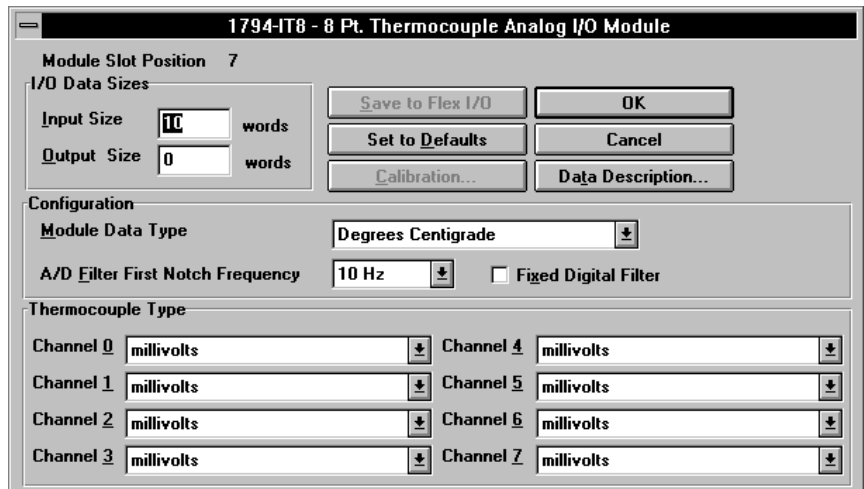

4. Click on  to get to the calibration screen.

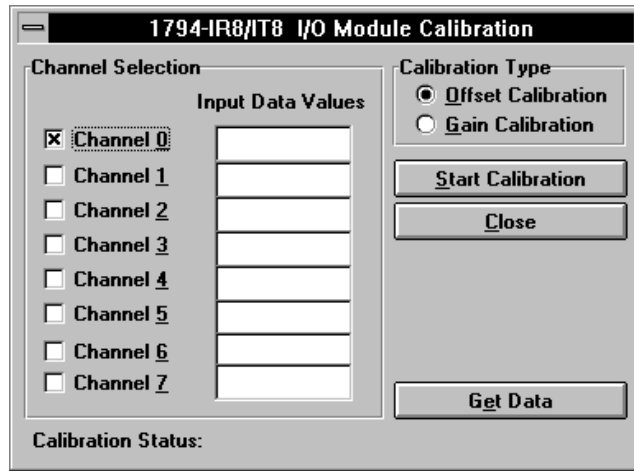

5. Click on the channels you want to calibrate.
6. Click on the radio button  for offset calibration. Then click on

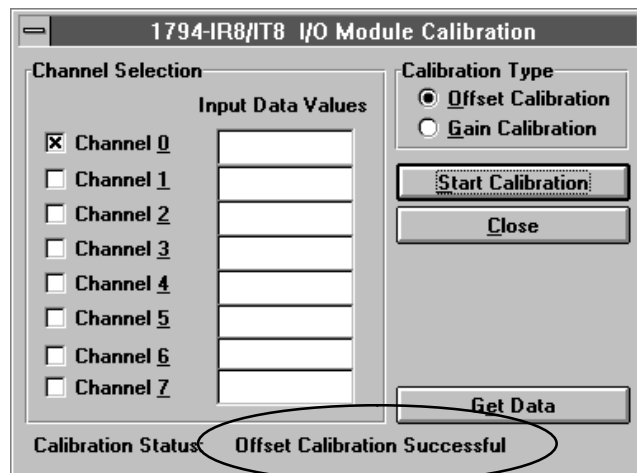

7. When calibration is complete, a notification will appear on the calibration status line.

## Gain Calibration

Make sure that you have calibrated the offset for this channel before calibrating the gain.

1. Connect 75.000mV across each input channel. Connect all high signal terminals together and attach to the positive lead from the precision voltage source. Connect all low signal terminals together and attach to the negative lead.
2. Click on the channels you want to calibrate.

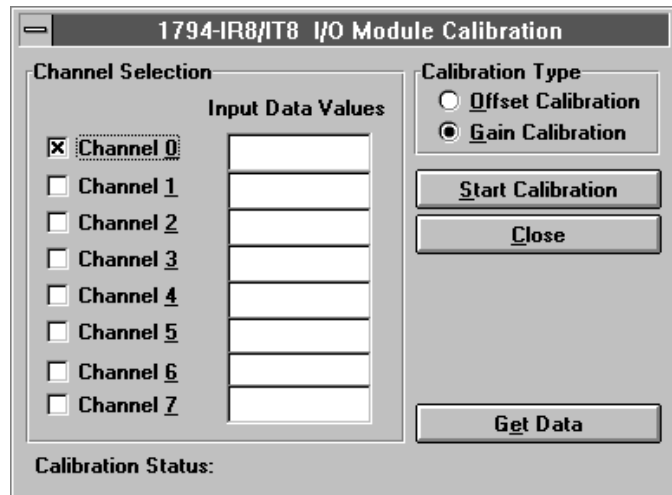

3. Click on the radio button  for gain calibration. Then click on

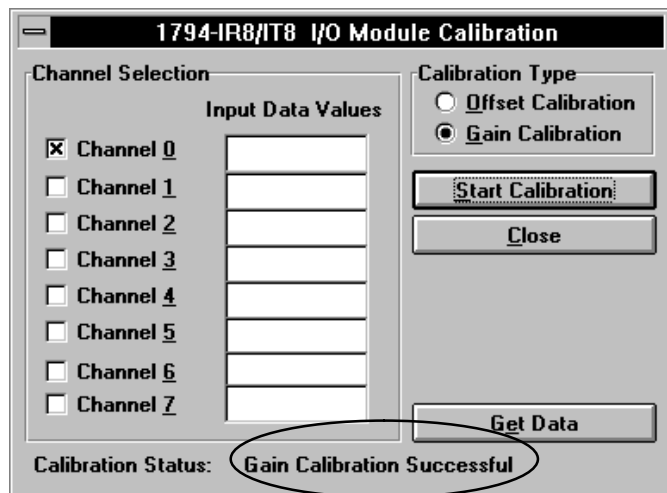

4. When calibration is complete, a notification will appear on the calibration status line.



The  button populates the screen with the actual values appearing at the inputs. Note that there is an implied decimal point to the left of the last 2 digits.. For example, channel 0 data value reads 7500. The actual reading is 75.00mV.

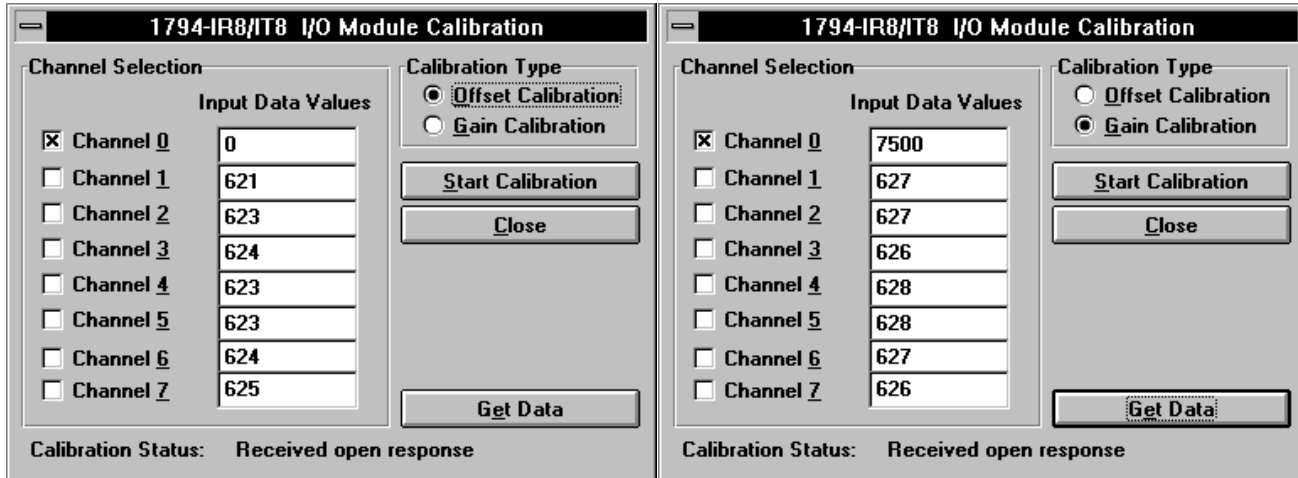

Channel Selection	Input Data Values
<input checked="" type="checkbox"/> Channel 0	0
<input type="checkbox"/> Channel 1	621
<input type="checkbox"/> Channel 2	623
<input type="checkbox"/> Channel 3	624
<input type="checkbox"/> Channel 4	623
<input type="checkbox"/> Channel 5	623
<input type="checkbox"/> Channel 6	624
<input type="checkbox"/> Channel 7	625

  

Channel Selection	Input Data Values
<input checked="" type="checkbox"/> Channel 0	7500
<input type="checkbox"/> Channel 1	627
<input type="checkbox"/> Channel 2	627
<input type="checkbox"/> Channel 3	626
<input type="checkbox"/> Channel 4	628
<input type="checkbox"/> Channel 5	628
<input type="checkbox"/> Channel 6	627
<input type="checkbox"/> Channel 7	626

After both offset and gain calibrations are successful, click on



You will be returned to the module configuration screen. Either save to the device (adapter), or save to a file by clicking on the appropriate button.

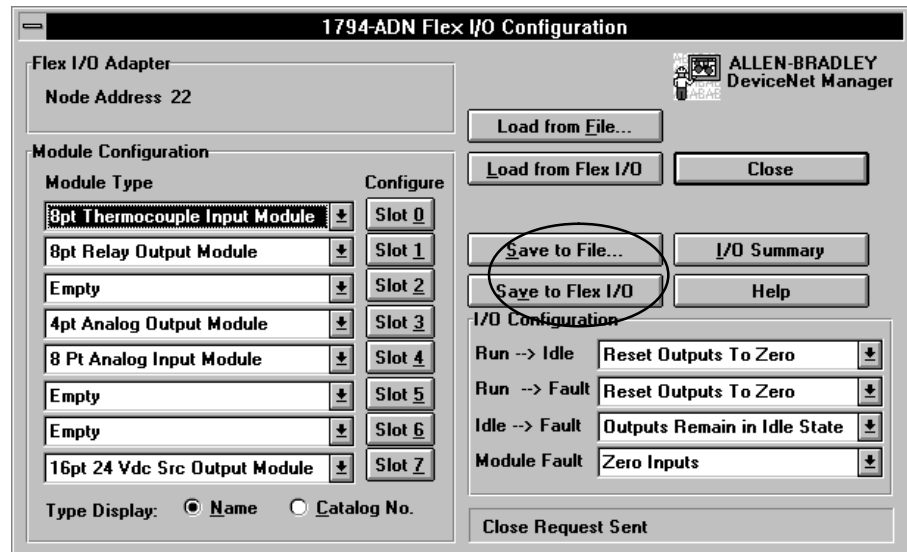

Flex I/O Adapter  
Node Address 22

Module Configuration

Module Type	Configure
8pt Thermocouple Input Module	Slot 0
8pt Relay Output Module	Slot 1
Empty	Slot 2
4pt Analog Output Module	Slot 3
8 Pt Analog Input Module	Slot 4
Empty	Slot 5
Empty	Slot 6
16pt 24 Vdc Src Output Module	Slot 7

Type Display:  Name  Catalog No.

I/O Configuration

Run --> Idle	Reset Outputs To Zero
Run --> Fault	Reset Outputs To Zero
Idle --> Fault	Outputs Remain in Idle State
Module Fault	Zero Inputs

Close Request Sent

# AB Parts

If you attempt to close without saving your configuration information by clicking on the  button, you will be prompted to save the changes.



## Specifications

<b>Specifications<sup>1</sup> – 1794-IT8 Thermocouple/mV Input Module</b>	
Number of Inputs	8 Channels
Module Location	Cat. No. 1794-TB2, -TB3 and -TB3T Terminal Base Units <sup>2</sup>
Nominal Input Voltage Ranges	+76.5mV
Supported Thermocouple Types	Type B: 300 to 1800°C (572 to 3272°F) Type C: 0 to 2315°C (32 to 4199°F) Type E: -270 to 1000°C (-454 to 1832°F) Type J: -210 to 1200°C (-346 to 2192°F) Type K: -270 to 1372°C (-454 to 2502°F) Type N: -270 to 1300°C (-450 to 2372°F) Type R: -50 to 1768°C (-58 to 3214°F) Type S: -50 to 1768°C (-58 to 3214°F) Type T: -270 to 400°C (-454 to 752°F)
Resolution	16 bits (2.384 microvolts typical)
Accuracy with fixed digital filter (at 24°C (+0.5°C))	0.025% Full Scale Range +0.5°C
Accuracy without fixed digital filter (at 24°C (+0.5°C))	0.05% Full Scale Range +0.5°C
Data Format	16-bit 2's complement or offset binary (unipolar)
Normal Mode Noise Rejection	-60db @ 60Hz
Common Mode Rejection	-115db @ 60Hz; -100db @ 50Hz
Common Mode Input Range	+10V
Channel to Channel Isolation	+10V
System Throughput	325ms (1 channel scanned), programmable to 28ms 2.6s (8 channels scanned), programmable to 224ms
Settling Time to 100% of final value	Available at system throughput rate
Open Circuit Detection	Out of range reading (upscale)
Open Thermocouple Detection Time	Available at system throughput rate
Overvoltage Capability	35V dc, 25V ac continuous @ 25°C 250V peak transient
Channel Bandwidth	0 to 2.62Hz (-3db) default
RFI Immunity	Error of less than 1% of range at 10V/M 27 to 1000MHz
Input Offset Drift with Temperature	+6 microvolts/°C maximum
Gain Drift with Temperature	10ppm/°C maximum
Overall Drift with Temperature	50ppm/°C of span (maximum)
Cold Junction Compensation Range	0 to 70°C
Cold Junction Compensator	A-B Part Number 969424-01
Indicators	1 red/green power status indicator
Flexbus Current	20mA
Power Dissipation	3W maximum @ 31.2V dc
Thermal Dissipation	Maximum 10.2 BTU/hr @ 31.2V dc
Keyswitch Position	3

**Specifications continued on next page.**

Specifications - 1794-IT8 Thermocouple/mV Input Module	
General Specifications	
External dc Power	
Supply Voltage	24V dc nominal
Voltage Range	19.2 to 31.2V dc (includes 5% ac ripple) 19.2V dc for ambient temperatures less than 55°C 24V dc for ambient temperatures less than 55°C 31.2V dc for ambient temperatures less than 40°C See derating curve.
Supply Current	150mA @ 24V dc
Cabling	
Thermocouples inputs	Appropriate shielded thermocouple extension wire <sup>3</sup> Belden 8761
Millivolt inputs	
Dimensions	
Inches	1.8H x 3.7W x 2.1D (45.7 x 94.0 x 53.3)
(Millimeters)	
Environmental Conditions	
Operational Temperature	0 to 55°C (32 to 131°F) See derating curve. -40 to 85°C (-40 to 185°F) 5 to 95% noncondensing (operating) 5 to 80% noncondensing (nonoperating) 30 g peak acceleration, 11(+1)ms pulse width 50 g peak acceleration, 11(+1)ms pulse width Tested 5 g @ 10-500Hz per IEC 68-2-6
Storage Temperature	
Relative Humidity	
Shock	
Operating	30 g peak acceleration, 11(+1)ms pulse width 50 g peak acceleration, 11(+1)ms pulse width
Non-operating	
Vibration	Tested 5 g @ 10-500Hz per IEC 68-2-6
Agency Certification (when product or packaging is marked)	<ul style="list-style-type: none"> <li>• CSA certified</li> <li>• CSA Class I, Division 2 Groups A, B, C, D certified</li> <li>• UL listed</li> <li>• CE marked for all applicable directives</li> </ul>
Installation Instructions	Publication 1794-5.21

<sup>1</sup> Specifications based on A/D filter first notch frequency of 10Hz.

<sup>2</sup> Use 1794-TB2 or -TB3 terminal base unit for millivolt inputs only. You must use a 1794-TB3T terminal base unit when using thermocouple inputs.

<sup>3</sup> Refer to the thermocouple manufacturer for the correct extension wire.

## Derating Curve

User Applied 24V dc Supply versus Ambient Temperature

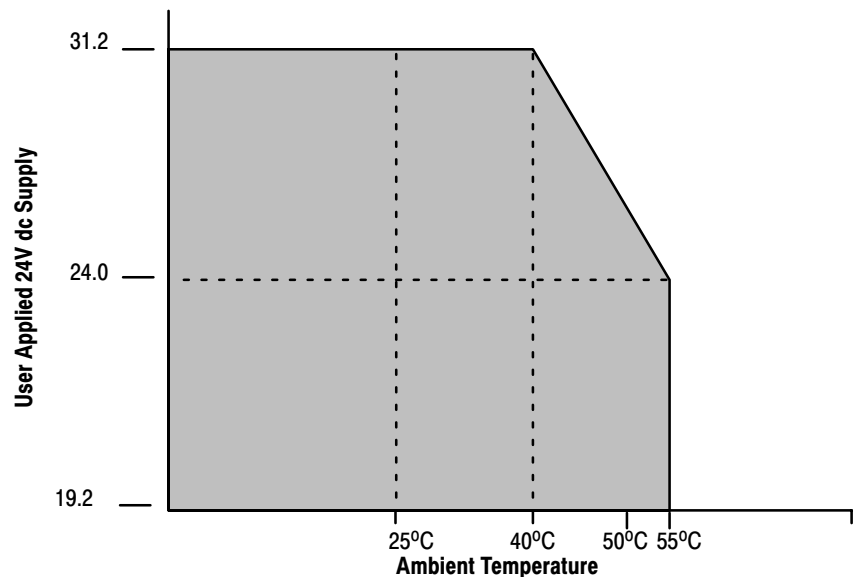

The area within the curve represents the safe operating range for the module under various conditions of user supplied 24V dc supply voltages and ambient temperatures.

 = Safe operating area

## Resolution Curves for Thermocouples

### Type B Thermocouple

Resolution $\frac{^{\circ}\text{C}}{^{\circ}\text{F}}$			
1000Hz	500Hz	250Hz	10-100Hz
102.4	25.60	6.40	0.80
184.3	46.08	11.52	1.44
89.60	22.40	5.60	0.70
161.3	40.32	10.08	1.26
76.80	19.20	4.80	0.60
138.2	34.56	8.64	1.08
64.00	16.00	4.00	0.50
115.2	28.80	7.20	0.90
51.20	12.80	3.20	0.40
92.16	23.04	5.76	0.72
38.40	9.60	2.40	0.30
69.12	17.28	4.32	0.54
25.60	6.40	1.60	0.20
46.08	11.52	2.88	0.36
12.80	3.20	0.80	0.10
23.04	5.76	1.44	0.18
0			

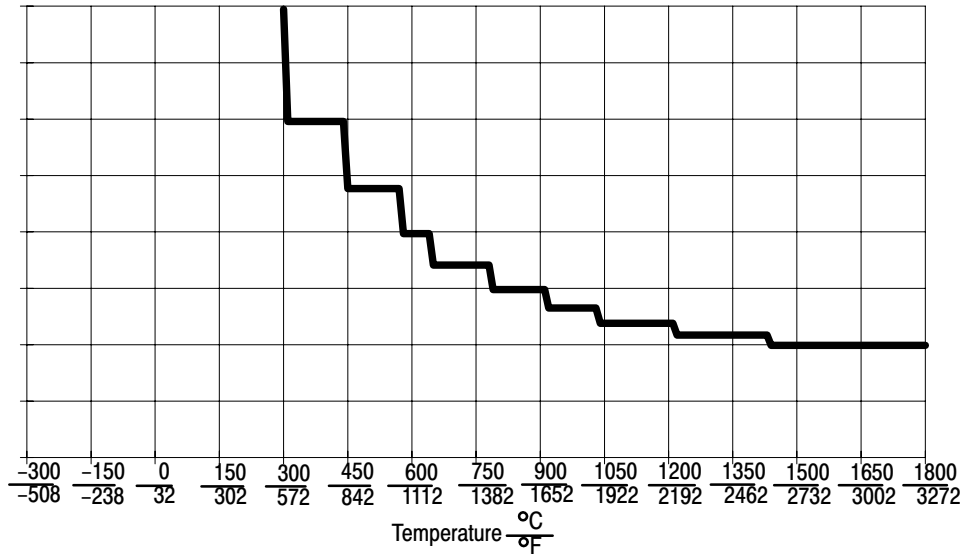

### Type E Thermocouple

Resolution $\frac{^{\circ}\text{C}}{^{\circ}\text{F}}$			
1000Hz	500Hz	250Hz	10-100Hz
64.00	16.00	4.00	0.50
115.2	28.80	7.20	0.90
51.20	12.80	3.20	0.40
92.16	23.04	5.76	0.72
38.40	9.60	2.40	0.30
69.12	17.28	4.32	0.54
25.60	12.80	1.60	0.20
46.08	11.52	2.88	0.36
12.80	6.40	0.80	0.10
23.04	5.76	1.44	0.18
0			

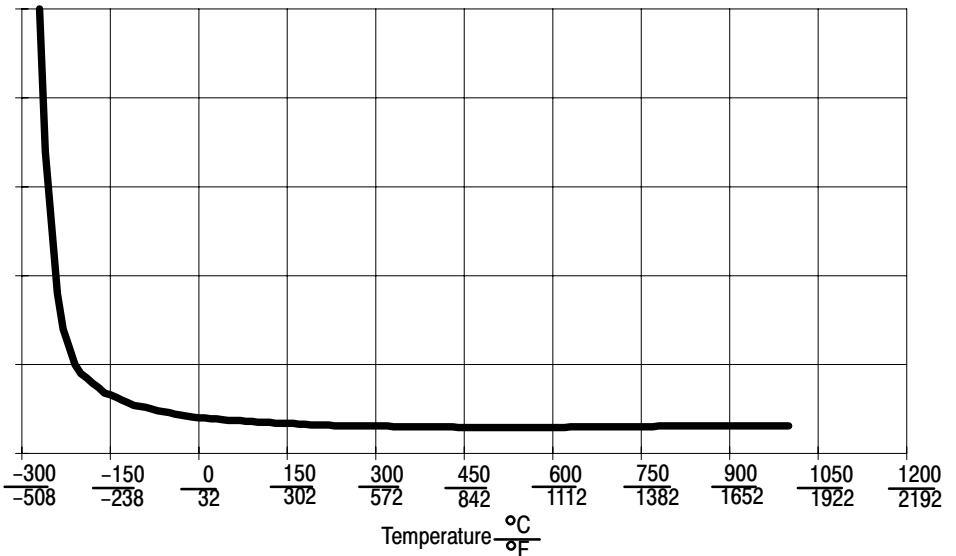

AB Parts

### Type C Thermocouple

Resolution $\frac{^{\circ}\text{C}}{^{\circ}\text{F}}$			
1000Hz	500Hz	250Hz	10-100Hz
32.00	8.00	2.00	0.25
57.60	14.4	3.60	0.45
25.60	6.40	1.60	0.20
46.08	11.52	2.88	0.36
19.20	4.80	1.20	0.15
34.56	8.64	2.16	0.27
12.80	3.20	0.80	0.10
23.04	5.76	1.44	0.18
6.400	1.60	0.40	0.05
11.52	2.88	0.72	0.09

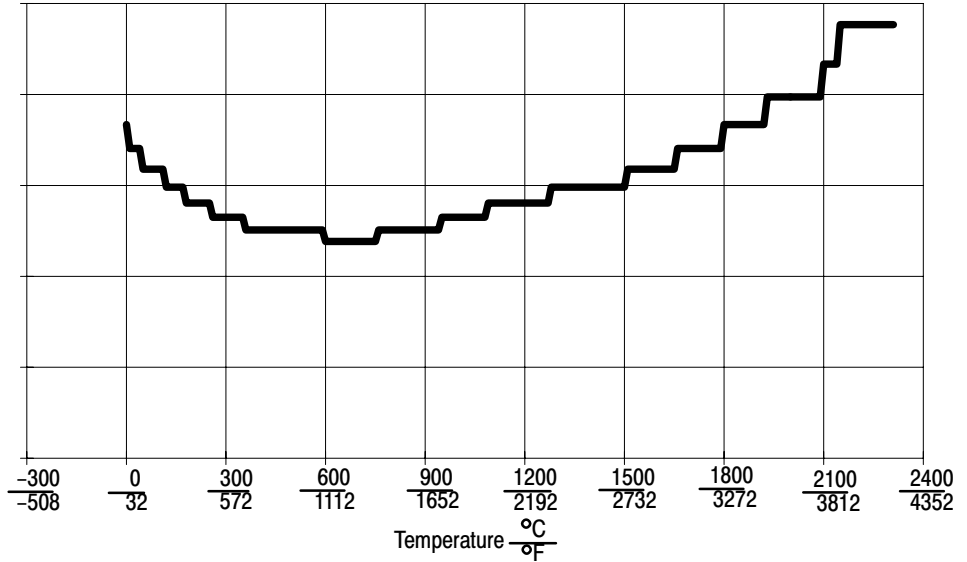

### Type J Thermocouple

Resolution $\frac{^{\circ}\text{C}}{^{\circ}\text{F}}$			
1000Hz	500Hz	250Hz	10-100Hz
17.92	4.480	1.120	0.140
32.25	8.064	2.016	0.252
15.36	3.840	0.960	0.120
27.65	6.912	1.728	0.216
12.80	3.200	0.800	0.100
23.04	5.760	1.440	0.180
10.24	2.560	0.640	0.080
18.43	4.608	1.152	0.144
7.680	1.920	0.480	0.060
13.82	3.456	0.864	0.108
5.120	1.280	0.320	0.040
9.216	2.304	0.576	0.072
2.560	0.640	0.160	0.020
4.608	1.152	0.288	0.036

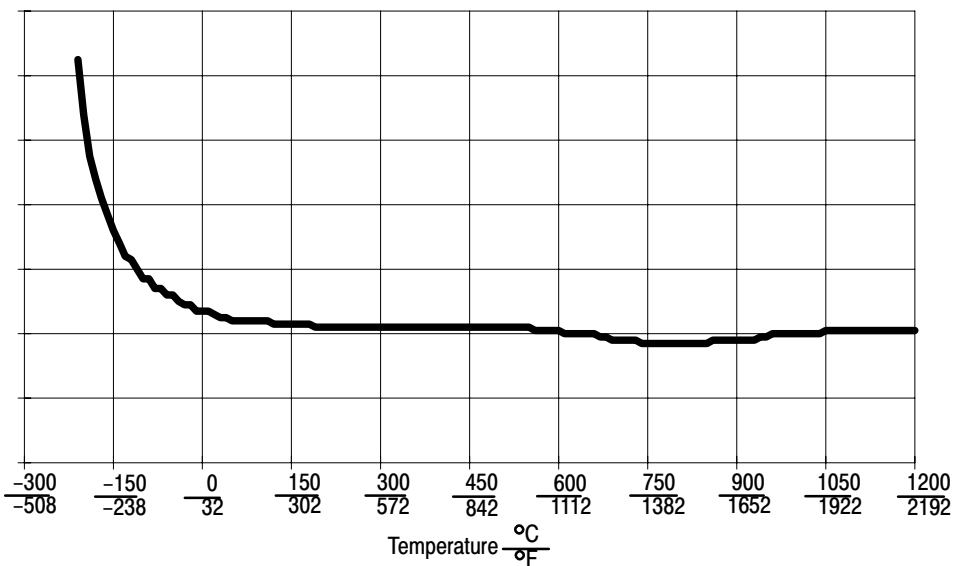

### Type K Thermocouple

Resolution $\frac{^{\circ}\text{C}}{^{\circ}\text{F}}$			
1000Hz	500Hz	250Hz	10-100Hz
128.0	32.00	8.000	1.000
230.4	57.60	14.40	1.800
102.4	25.60	6.400	0.800
184.3	46.08	11.52	1.440
76.80	19.20	4.800	0.600
138.2	34.56	8.640	1.080
51.20	12.80	3.200	0.400
92.16	23.04	5.760	0.720
25.60	6.400	1.600	0.200
46.08	11.52	2.880	0.360

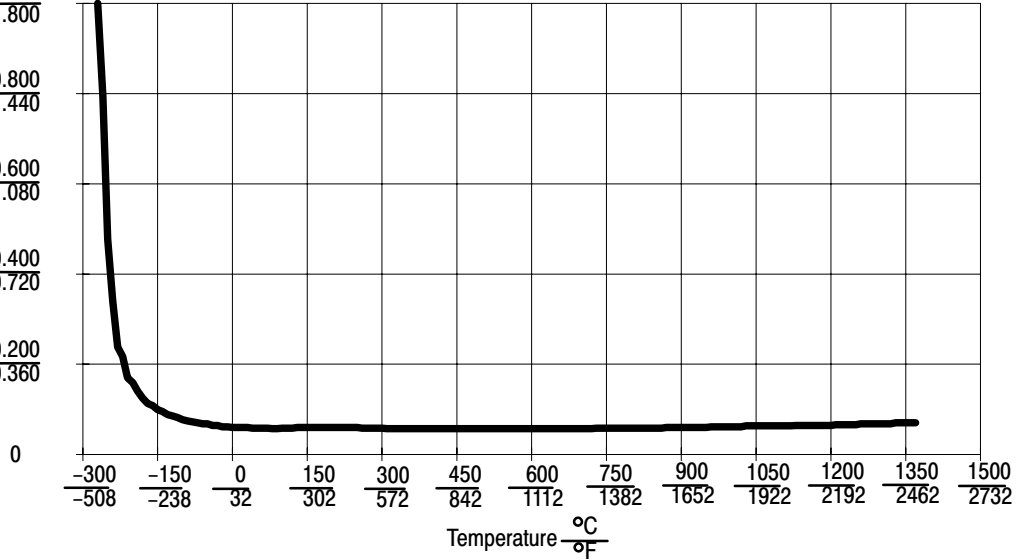

### Type R Thermocouple

Resolution $\frac{^{\circ}\text{C}}{^{\circ}\text{F}}$			
1000Hz	500Hz	250Hz	10-100Hz
102.4	25.60	6.40	0.80
184.3	46.08	11.52	1.44
76.80	19.20	4.80	0.60
138.2	34.56	8.64	1.08
51.20	12.80	3.20	0.40
92.16	23.04	5.76	0.72
25.60	6.40	1.60	0.20
46.08	11.52	2.88	0.36

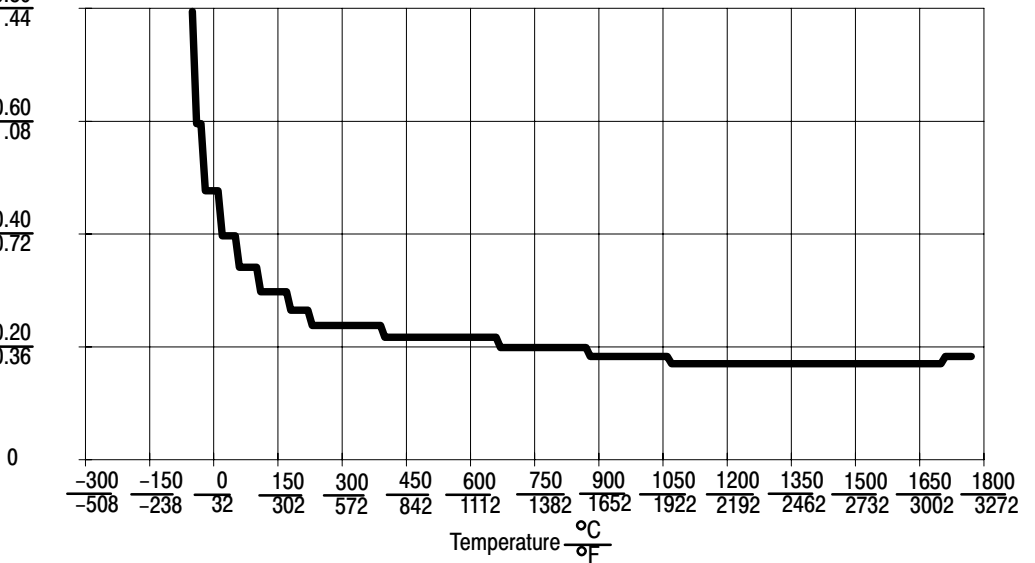

### Type S Thermocouple

Resolution $\frac{^{\circ}\text{C}}{^{\circ}\text{F}}$			
1000Hz	500Hz	250Hz	10-100Hz
76.80	19.20	4.80	0.60
138.2	34.56	8.64	1.08
64.00	16.00	4.00	0.50
115.2	28.80	7.20	0.90
51.20	12.80	3.20	0.40
92.16	23.04	5.76	0.72
38.40	9.60	2.40	0.30
69.12	17.28	4.32	0.54
25.60	6.40	1.60	0.20
46.08	11.52	2.88	0.36
12.80	3.20	0.80	0.10
23.04	5.76	1.44	0.18

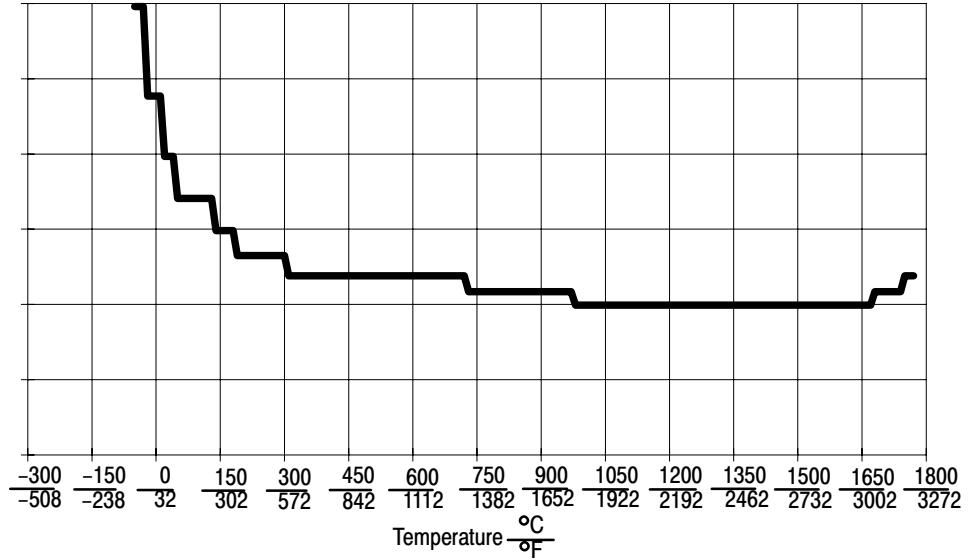

### Type T Thermocouple

Resolution $\frac{^{\circ}\text{C}}{^{\circ}\text{F}}$			
1000Hz	500Hz	250Hz	10-100Hz
102.4	25.60	6.40	0.80
184.3	46.08	11.52	1.44
89.60	22.40	5.60	0.70
161.3	40.32	10.08	1.26
76.80	19.20	4.80	0.60
138.2	34.56	8.64	1.08
64.00	16.00	4.00	0.50
115.2	28.80	7.20	0.90
51.20	12.80	3.20	0.40
92.16	23.04	5.76	0.72
38.40	9.60	2.40	0.30
69.12	17.28	4.32	0.54
25.60	6.40	1.60	0.20
46.08	11.52	2.88	0.36
12.80	3.20	0.80	0.10
23.04	5.76	1.44	0.18

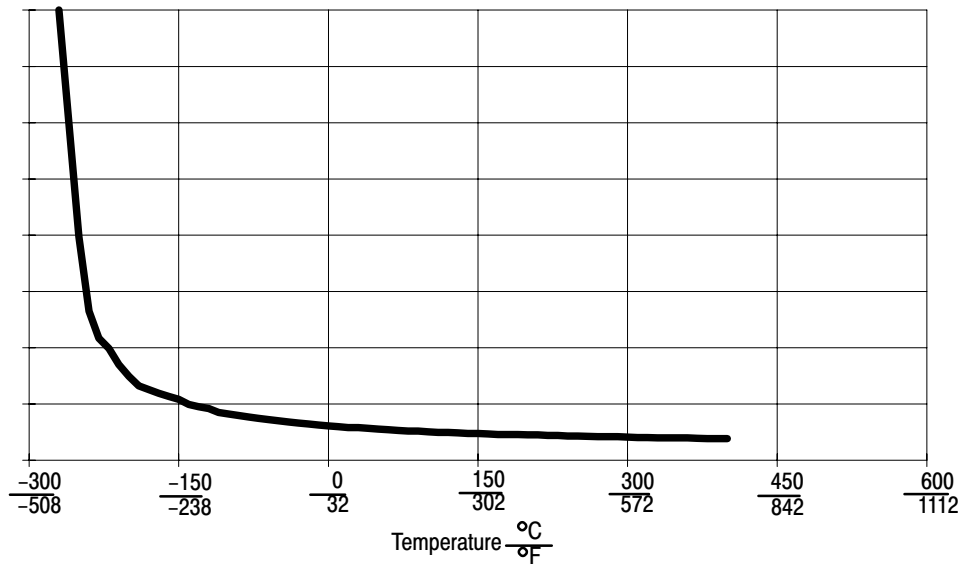



### Type N Thermocouple

Resolution $\frac{^{\circ}\text{C}}{^{\circ}\text{F}}$			
1000Hz	500Hz	250Hz	10-100Hz
128.0	32.00	8.00	1.00
230.4	57.60	14.40	1.80
102.4	25.60	6.40	0.80
184.3	46.08	11.52	1.44
76.80	19.20	4.80	0.60
138.2	34.56	8.64	1.08
51.20	12.80	3.20	0.40
92.16	23.04	5.76	0.72
25.60	6.40	1.60	0.20
46.08	11.52	2.88	0.36

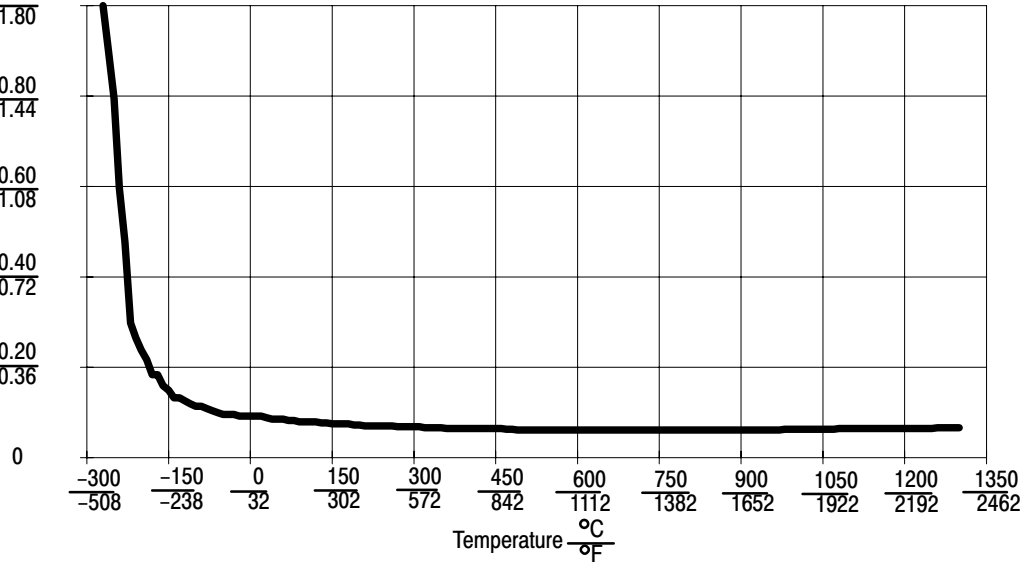

### Worst Case Accuracy for the Thermocouple/mV Module

Input Type	Accuracy @ 25°C	Accuracy @ 77°F	Temperature Drift (0-60°C) (32-°F)	
B	$\pm 3.70^{\circ}\text{C}$	$\pm 6.66^{\circ}\text{F}$	$\pm 0.710^{\circ}\text{C}/^{\circ}\text{C}$	$\pm 0.710^{\circ}\text{F}/^{\circ}\text{F}$
E	$\pm 0.51^{\circ}\text{C}$	$\pm 0.92^{\circ}\text{F}$	$\pm 0.104^{\circ}\text{C}/^{\circ}\text{C}$	$\pm 0.104^{\circ}\text{F}/^{\circ}\text{F}$
J	$\pm 0.68^{\circ}\text{C}$	$\pm 1.22^{\circ}\text{F}$	$\pm 0.130^{\circ}\text{C}/^{\circ}\text{C}$	$\pm 0.130^{\circ}\text{F}/^{\circ}\text{F}$
K	$\pm 1.00^{\circ}\text{C}$	$\pm 1.80^{\circ}\text{F}$	$\pm 0.186^{\circ}\text{C}/^{\circ}\text{C}$	$\pm 0.186^{\circ}\text{F}/^{\circ}\text{F}$
R	$\pm 3.16^{\circ}\text{C}$	$\pm 5.69^{\circ}\text{F}$	$\pm 0.601^{\circ}\text{C}/^{\circ}\text{C}$	$\pm 0.601^{\circ}\text{F}/^{\circ}\text{F}$
S	$\pm 3.70^{\circ}\text{C}$	$\pm 6.67^{\circ}\text{F}$	$\pm 0.651^{\circ}\text{C}/^{\circ}\text{C}$	$\pm 0.651^{\circ}\text{F}/^{\circ}\text{F}$
T	$\pm 0.67^{\circ}\text{C}$	$\pm 1.21^{\circ}\text{F}$	$\pm 0.174^{\circ}\text{C}/^{\circ}\text{C}$	$\pm 0.174^{\circ}\text{F}/^{\circ}\text{F}$
N	$\pm 1.07^{\circ}\text{C}$	$\pm 1.93^{\circ}\text{F}$	$\pm 0.223^{\circ}\text{C}/^{\circ}\text{C}$	$\pm 0.223^{\circ}\text{F}/^{\circ}\text{F}$
C	$\pm 3.40^{\circ}\text{C}$	$\pm 6.12^{\circ}\text{F}$	$\pm 0.434^{\circ}\text{C}/^{\circ}\text{C}$	$\pm 0.434^{\circ}\text{F}/^{\circ}\text{F}$
mV	$\pm 39\mu\text{V}$	$\pm 39\mu\text{V}$	$\pm 7.812\mu\text{V}/^{\circ}\text{C}$	$\pm 14.06\mu\text{V}/^{\circ}\text{F}$

## Error Due to Open Circuit Current Through Loop Resistance

Input Type	Error per Ohm of Loop Resistance	
	B	0.091°C
E	0.013°C	0.023°F
J	0.016°C	0.029°F
K	0.024°C	0.043°F
R	0.076°C	0.137°F
S	0.083°C	0.149°F
T	0.022°C	0.040°F
N	0.028°C	0.050°F
C	0.055°C	0.099°F
mV	0.417 $\mu$ V (2.4 $\Omega$ = 1 LSB of error)	

## Worst Case Repeatability for the Thermocouple/mV Input Module

Input Type	Repeatability with Filter		Repeatability without Filter	
	(°C)	(°F)	(°C)	(°F)
B	$\pm$ 1.00°C	$\pm$ 1.80°F	$\pm$ 2.00°C/°C	$\pm$ 3.60°F/°F
E	$\pm$ 0.16°C	$\pm$ 0.29°F	$\pm$ 0.32°C/°C	$\pm$ 0.58°F/°F
J	$\pm$ 0.20°C	$\pm$ 0.36°F	$\pm$ 0.40°C/°C	$\pm$ 0.72°F/°F
K	$\pm$ 0.28°C	$\pm$ 0.50°F	$\pm$ 0.56°C/°C	$\pm$ 1.00°F/°F
R	$\pm$ 1.10°C	$\pm$ 1.98°F	$\pm$ 2.20°C/°C	$\pm$ 3.96°F/°F
S	$\pm$ 1.00°C	$\pm$ 1.80°F	$\pm$ 2.00°C/°C	$\pm$ 3.60°F/°F
T	$\pm$ 0.27°C	$\pm$ 0.54°F	$\pm$ 0.54°C/°C	$\pm$ 1.08°F/°F
N	$\pm$ 0.34°C	$\pm$ 0.61°F	$\pm$ 0.68°C/°C	$\pm$ 1.22°F/°F
C	$\pm$ 0.13°C	$\pm$ 0.23°F	$\pm$ 0.26°C/°C	$\pm$ 0.46°F/°F
mV	$\pm$ 12 $\mu$ V	$\pm$ 12 $\mu$ V	$\pm$ 24 $\mu$ V/°C	$\pm$ 24 $\mu$ V/°F

**Note:** The filter is enabled by setting bit 02 in write word 0.

## **Thermocouple Restrictions (Extracted from NBS Monograph 125 (IPTS-68))**

### **General**

Following are some restrictions extracted from NBS Monograph 125 (IPTS-68) issued March 1974 on thermocouples B, E, J, K, R, S and T:

### **B (Platinum - 30% Rhodium vs Platinum - 6% Rhodium) Type Thermocouples**

“The ASTM manual STP 470 [1970] indicates the following restrictions on the use of B type thermocouples at high temperatures: They should not be used in reducing atmospheres, nor in those containing metallic or nonmetallic vapors, unless suitably protected with nonmetallic protecting tubes. They should never be inserted directly into a metallic primary tube.”

“At temperatures below 450C the Seebeck coefficient of Type B thermocouples becomes quite small and is almost negligible in the normal room temperature range. Consequently, in most applications the reference junction temperature of the thermocouple does not need to be controlled or even known, as long as it is between 0 and 50C.”

Studies have shown that “a 0.1 percent change in the Rhodium content of the Pt-30% Rh thermoelement produces a corresponding change in the thermocouple voltage of about 15uV (i.e. 1.3C) at 1500C. In contrast a change of only .01% in the Rhodium content of Pt-6% Rh thermoelement also produces a voltage change of about 15uV (1.3C) at this temperature.”

“The thermoelectric voltages of Type B thermocouples is sensitive to their history of annealing, heat treatment and quenching. Calibration of Type B wires above 1600C is undesirable in most circumstances.”

“ASTM Standard E230-72 in the Annual Book of ASTM Standards [1972] specifies that the standard limits of error for Type B commercial thermocouples be + 1/2 percent between 871 and 1705C. Limits of error are not specified for Type B thermocouples below 871C. The recommended upper temperature limit for protected thermocouples, 1705C, applies to AWG 24 (0.5mm) wire.”

### **E (Nickel–Chromium vs Copper–Nickel <Constantan\*>) Type Thermocouple**

“Type E thermocouples are recommended by the ASTM Manual [1970] for use in the temperature range from –250 to 871C in oxidizing or inert atmospheres. The negative thermoelement is subject to deterioration above about 871C, but the thermocouple may be used up to 1000C for short periods.”

“The ASTM Manual [1970] indicates the following restrictions .. at high temperatures. They should not be used in sulfurous, reducing or alternately reducing and oxidizing atmospheres unless suitably protected with protecting tubes. They should not be used in vacuum (at high temperatures) for extended times, because the Chromium in the positive thermoelement vaporizes out of solution and alters the calibration. They should also not be used in atmospheres that promote ”green–rot” corrosion (those with low, but not negligible, oxygen content).”

“The negative thermoelement, a copper–nickel alloy, is subject to composition changes under thermal neutron irradiation since the copper is converted to nickel and zinc.”

“ASTM Standard E230–72 in the Annual Book of ASTM Standards [1972] specifies that the standard limits of error for the Type E commercial thermocouples be  $\pm 1.7\text{C}$  between 0 and 316C and  $\pm 1/2$  percent between 316 and 871C. Limits of error are not specified for Type E thermocouples below 0C. Type E thermocouples can also be supplied to meet special limits of error, which are less than the standard limits of error given above:  $\pm 1.25\text{C}$  between 0 and 316C and  $\pm 3/8$  percent between 316 and 871C. The recommended upper temperature limit for protected thermocouples, 871C, applies to AWG 8 (3.3mm) wire. For smaller wires the recommended upper temperature decreases to 649C for AWG 14 (1.6mm), 538C for AWG 20 (.8mm) and 427C for AWG 24 or 28 (0.5 or 0.3mm).

### **J (Iron vs Copper–Nickel <Constantan\*>) Type Thermocouple**

The J thermocouple “is the least suitable for accurate thermometry because there are significant nonlinear deviations in the thermoelectric output from different manufacturers. ... The total and specific types of impurities that occur in commercial iron change with time, location of primary ores, and methods of smelting.”

“Type J thermocouples are recommended by the ASTM [1970] for use in the temperature range from 0 to 760C in vacuum, oxidizing, reducing or inert atmospheres. If used for extended times above 500C, heavy gage wires are recommended because the oxidation rate is rapid at elevated temperatures.”

“They should not be used in sulfurous atmospheres above 500C. Because of potential rusting and embrittlement, they are not recommended for subzero temperatures. They should not be cycled above 760C even for a short time if accurate readings below 760C are desired at a later time.”

“The negative thermoelement, a copper–nickel alloy, is subject to substantial composition changes under thermal neutron irradiation, since copper is converted to nickel and zinc.”

“Commercial iron undergoes a magnetic transformation near 769C and <an alpha – gamma> crystal transformation near 910C. Both of these transformations, especially the latter, seriously affect the thermoelectric properties of iron, and therefore, the Type J thermocouples. If Type J thermocouples are taken to high temperatures, especially above 900C, they will lose accuracy of their calibration when they are recycled to lower temperatures.”

“ASTM Standard E230–72 in the Annual Book of ASTM Standards [1972] specifies that the standard limits of error for Type J commercial thermocouples be  $\pm 2.2$ C between 0 and 277C and  $\pm 3/4$  percent between 277 and 760C. Limits of error are not specified for Type J thermocouples below 0C or above 760C. Type J thermocouples can also be supplied to meet special limits of error, which are equal to one half the limits given above. The recommended upper temperature limit for protected thermocouples, 760C, applies to AWG 8 (3.3mm) wire. For smaller wires the recommended upper temperature decrease to 593C for AWG 14 (1.6mm), and 371C for AWG 24 or 28 (0.5 or 0.3mm).

\* It should be noted that the Constantan element of Type J thermoelements is NOT interchangeable with the Constantan element of Types T or N due to the different ratio of copper and nickel in each.

### **K (Nickel–Chromium vs Nickel–Aluminum) Type Thermocouple**

“This type is more resistant to oxidation at elevated temperatures than the Types E, J or T thermocouples and consequently it finds wide application at temperatures above 500C.”

“Type K thermocouples may be used at” liquid hydrogen temperatures. However, their Seebeck coefficient (about 4 $\mu$ V/K at 20K) is only about one-half of that of Type E thermocouples. Furthermore, the thermoelectric homogeneity of KN thermoelements is generally not quite as good as that of EN thermoelements. Both the KP and the KN thermoelements do have a relatively low thermal conductivity and good resistance to corrosion in moist atmospheres at low temperatures.”

“Type K thermocouples are recommended by the ASTM [1970] for continuous use at temperatures within the range –250 to 1260C in oxidizing or inert atmospheres. Both the KP and the KN thermoelements are subject to oxidation when used in air above about 850C, but even so, Type K thermocouples may be used at temperatures up to about 1350C for short periods with only small changes in calibration.”

“They should not be used in sulfurous, reducing, or alternately reducing and oxidizing atmospheres unless suitably protected with protecting tubes. They should not be used in vacuum (at high temperatures) for extended times because the Chromium in the positive thermoelement vaporizes out of solution and alters the calibration. They should also not be used in atmospheres that promote ”green-rot” corrosion (those with low, but not negligible, oxygen content).”

“ASTM Standard E230–72 in the Annual Book of ASTM Standards [1972] specifies that the standard limits of error for Type K commercial thermocouples be  $\pm 2.2$ C between 0 and 277C and  $\pm 3/4$  percent between 277 and 1260C. Limits of error are not specified for the Type K thermocouples below 0C. Type K thermocouples can also be supplied to meet special limits of error, which are equal to one half the standard limits of error given above. The recommended upper temperature limit for protected Type K thermocouples, 1260C, applies for AWG 8 (3.3mm) wire. For smaller wires it decreases to 1093C for AWG 14 (1.6mm), 982C for AWG 20 (0.8mm), and 871C for AWG 24 or 28 (0.5 or 0.3mm).”

### **R (Platinum-13% Rhodium vs Platinum) and S (Platinum-10% Rhodium vs Platinum) Type Thermocouples**

“The ASTM manual STP 470 [1970] indicates the following restrictions on the use of S {and R} type thermocouples at high temperatures: They should not be used in reducing atmospheres, nor in those containing metallic vapor (such as lead or zinc), nonmetallic vapors (such as arsenic, phosphorous or sulfur) or easily reduced oxides, unless suitably protected with nonmetallic protecting tubes. They should never be inserted directly into a metallic primary tube.”

“The positive thermoelement, platinum-10% rhodium {13% rhodium for R}, is unstable in a thermal neutron flux because the rhodium converts to palladium. The negative thermoelement, pure platinum, is relatively stable to neutron transmutation. However, fast neutron bombardment will cause physical damage, which will change the thermoelectric voltage unless it is annealed out.”

“The thermoelectric voltages of platinum based thermocouples are sensitive to their heat treatments. In particular, quenching from high temperatures should be avoided.”

“ASTM Standard E230-72 in the Annual Book of ASTM Standards [1972] specifies that the standard limits of error for Type S {and R} commercial thermocouples be  $\pm 1.4^{\circ}\text{C}$  between 0 and  $538^{\circ}\text{C}$  and  $\pm 1/4\%$  between 538 and  $1482^{\circ}\text{C}$ . Limits of error are not specified for Type S {or R} thermocouples below  $0^{\circ}\text{C}$ . The recommended upper temperature limit for continuous use of protected thermocouples,  $1482^{\circ}\text{C}$ , applies to AWG 24 (0.5mm) wire.

### **T (Copper vs Copper-Nickel <Constantan\*>) Type Thermocouple**

“The homogeneity of most Type TP and TN (or EN) thermoelements is reasonably good. However, the Seebeck coefficient of Type T thermocouples is moderately small at subzero temperatures (about  $5.6\mu\text{V}/\text{K}$  at  $20\text{K}$ ), being roughly two-thirds that of Type E thermocouples. This, together with the high thermal conductivity of Type TP thermoelements, is the major reason why Type T thermocouples are less suitable for use in the subzero range than Type E thermocouples.”

“Type T thermocouples are recommended by the ASTM [1970] for use in the temperature range from  $-184$  to  $371\text{C}$  in vacuum or in oxidizing, reducing or inert atmospheres. The recommended upper temperature limit for continuous service of protected Type T thermocouples is set at  $371\text{C}$  for AWG 14 (1.6mm) thermoelements, since Type TP thermoelements oxidize rapidly above this temperature. However, the thermoelectric properties of Type TP thermoelements are apparently not grossly affected by oxidation since Roeser and Dahl [1938] observed negligible changes in the thermoelectric voltage of Nos. 12, 18, and 22 AWG Type TP thermoelements after heating for 30 hours in air at  $500\text{C}$ . At this temperature the Type TN thermoelements have good resistance to oxidation and exhibit only small changes in thermal emf with long exposure in air, as shown by the studies of Dahl [1941].” ...

“Operation of Type T thermocouples in hydrogen atmospheres at temperatures above about  $370\text{C}$  is not recommended since severe embrittlement of the Type TP thermoelements may occur.”

“Type T thermoelements are not well suited for use in nuclear environments, since both thermoelements are subject to significant changes in composition under thermal neutron irradiation. The copper in the thermoelement is converted to nickel and zinc.”

“Because of the high thermal conductivity of Type TP thermoelements, special care should be exercised in the use of the thermocouples to insure that both the measuring and reference junctions assume the desired temperatures.”

ASTM Standard E230-72 in the Annual Book of ASTM Standards [1972] specifies that the standard limits of error for Type T commercial thermocouples be  $\pm 2$  percent between  $-101$  and  $-59\text{C}$ ,  $\pm 0.8\text{C}$  between  $-59$  and  $93\text{C}$  and  $\pm 3/4$  percent between  $93$  and  $371\text{C}$ . Type T thermocouples can also be supplied to meet special limits of error, which are equal to one half the standard limits of error given above (plus a limit of error of  $\pm 1$  percent is specified between  $-184$  and  $-59\text{C}$ ). The recommended upper temperature limit for protected Type T thermocouples,  $371\text{C}$ , applies to AWG 14 (1.6mm) wire. For smaller wires it decreases to  $260\text{C}$  for AWG 20 (0.8mm) and  $240\text{C}$  for AWG 24 or 28 (0.5 or 0.3mm).

Use this template for your appendices. If it were not for the different running head, this would be your chapter 4 document.



## Symbols

\*\*Empty\*\*, [1](#), [P-1](#), [P-2](#), [1-1](#), [1-3](#),  
[2-1](#), [3-4](#), [6-1](#), [6-2](#), [B-1](#), [6-1](#)

## Numbers

1794-TB3 example, thermocouple  
connection, [2-7](#)

## A

accuracy, worst case, [A-7](#)  
adapter input status word, [5-1](#)  
audience, [P-1](#)

## B

bit/word description, thermocouple module,  
1794-IT8, [4-5](#), [5-4](#)  
block transfer  
read, [1-2](#)  
write, [1-2](#)  
block transfer programming, [3-1](#)  
block transfer read, [4-4](#)  
1794-IT8, [4-4](#), [5-3](#)  
block transfer write  
1794-IT8, [4-5](#), [5-4](#)  
configuration block, 1794-IT8, [4-5](#),  
[5-4](#)  
input range selection, [4-2](#)

## C

calibration  
gain, [6-8](#)  
manual, [6-4](#)  
offset, [6-7](#)  
periodic, [6-1](#)  
preparation, [6-4](#)  
setups, [6-6](#)  
tools, [6-2](#)  
types of, [6-1](#)  
using decade box, [6-6](#)  
using DeviceNetManager, [6-9](#)  
using resistors, [6-6](#)  
calibration flow chart, [6-5](#)  
calibration words, [6-7](#)  
cold junction compensators, [1-3](#)

cold junction connection wiring, [2-6](#)  
communication, between module and  
adapter, [1-2](#)  
compatible terminal bases, [2-5](#)  
configurable features, [4-1](#)  
connecting CJC, [2-6](#)  
connecting wiring, [2-5](#), [6-6](#)  
considerations, pre-installation, [2-1](#)  
current draw, through base units, [2-2](#)  
curve  
derating, [A-2](#)  
supply voltage vs. ambient temperature,  
[A-2](#)  
curves, resolution, [A-3](#)

## D

daisy-chaining wiring, [2-3](#)  
default values, [5-7](#)  
derating curve, [A-2](#)  
DeviceNetManager, software, [5-1](#)  
DeviceNetManager software, [6-9](#)

## E

example  
thermocouple/1794-TB3, [2-7](#)  
thermocouple/1794-TB3T, [2-7](#)

## F

features, of the module, [1-3](#)  
first notch filter, [4-3](#)  
flow chart, calibration, [6-5](#)

## G

gain calibration, [6-8](#)  
using DeviceNetManager, [6-11](#)

## I

I/O module fault, [5-2](#)  
indicators  
states, [2-8](#)  
status, [2-8](#)

input ranges, [4-2](#)  
input scaling, [4-2](#)  
input status word, [5-2](#)  
installation, module, [2-4](#)

## K

keyswitch positions, [2-4](#)

## M

manual calibration, [6-4](#)  
mapping, 1794-IT8, [4-4](#), [5-3](#)  
module, shipping state, [6-1](#)  
module fault, [5-2](#)  
module features, [1-3](#)  
module installation, [2-4](#)

## O

offset calibration, [6-7](#)  
    using DeviceNetManager, [6-9](#)  
open circuit error, [A-8](#)  
optimal defaults, [5-7](#)

## P

PLC-2 programming, [3-4](#)  
polled I/O, structure, [5-1](#)  
power defaults, [5-7](#)  
preparing for calibration, [6-4](#)  
programming example  
    PLC-3, [3-2](#)  
    PLC-5, [3-3](#)

## R

range, selecting, [4-2](#)

read/write words, for calibration, [6-7](#)  
removing and replacing, under power (RIUP), [2-4](#)  
repeatability, worst case, [A-8](#)  
resolution curves, [A-3](#)  
    type B thermocouple, [A-3](#)  
    type C thermocouple, [A-4](#)  
    type E thermocouple, [A-3](#)  
    type J thermocouple, [A-4](#)  
    type K thermocouple, [A-5](#)  
    type N thermocouple, [A-7](#)  
    type R thermocouple, [A-5](#)  
    type S thermocouple, [A-6](#)  
    type T thermocouple, [A-6](#)

## S

sample program, [3-4](#)  
scaling, [4-2](#)  
software, DeviceNetManager, [5-1](#)  
specifications, thermocouple, [A-1](#)  
status indicators, [2-8](#)  
system throughput, [5-3](#)

## T

terminal bases, compatible, [2-5](#)  
thermocouple input mapping, 1794-IT8,  
    [4-4](#), [5-3](#)  
thermocouple/1794-TB3T example, [2-7](#)  
throughput, normal mode, [4-3](#)

## W

wiring  
    connections, [6-6](#)  
    methods of, [2-3](#)  
    to terminal bases, [2-1](#)  
wiring connections, [2-5](#)  
    1794-IT8, [2-6](#), [6-6](#)



# Allen-Bradley Publication Problem Report

If you find a problem with our documentation, please complete and return this form.

Pub. Name 8 Input Thermocouple/mV User Manual

Cat. No. 1794-IT8 Pub. No. 1794-6.5.7 Pub. Date March 1996 Part No. 9551124-33

Check Problem(s) Type:	Describe Problem(s):	Internal Use Only
<input type="checkbox"/> Technical Accuracy	<input type="checkbox"/> text <input type="checkbox"/> illustration	
<input type="checkbox"/> Completeness What information is missing?	<input type="checkbox"/> procedure/step <input type="checkbox"/> illustration <input type="checkbox"/> definition <input type="checkbox"/> example <input type="checkbox"/> guideline <input type="checkbox"/> feature <input type="checkbox"/> explanation <input type="checkbox"/> other	<input type="checkbox"/> info in manual (accessibility) <input type="checkbox"/> info not in manual
<input type="checkbox"/> Clarity What is unclear?		
<input type="checkbox"/> Sequence What is not in the right order?		
<input type="checkbox"/> Other Comments Use back for more comments.		

Your Name \_\_\_\_\_ Location/Phone \_\_\_\_\_

Return to: Marketing Communications, Allen-Bradley Co., 1 Allen-Bradley Drive, Mayfield Hts., OH 44124-6118 Phone: (216)646-3176  
FAX: (216)646-4320

PLEASE FASTEN HERE (DO NOT STAPLE)

Other Comments

PLEASE FOLD HERE

PLEASE REMOVE

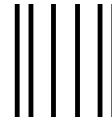

NO POSTAGE  
NECESSARY  
IF MAILED  
IN THE  
UNITED STATES

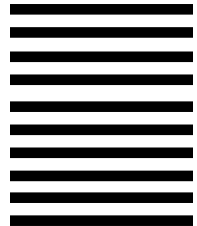

**BUSINESS REPLY MAIL**

FIRST-CLASS MAIL PERMIT NO. 18235 CLEVELAND OH

POSTAGE WILL BE PAID BY THE ADDRESSEE



**Allen-Bradley**

1 ALLEN BRADLEY DR  
MAYFIELD HEIGHTS OH 44124-9705



## **Support Services**

At Allen-Bradley, customer service means experienced representatives at Customer Support Centers in key cities throughout the world for sales service and support. Our value-added services include:

### **Technical Support**

- SupportPlus programs
- telephone support and 24-hour emergency hotline
- software and documentation updates
- technical subscription services

### **Engineering and Field Services**

- application engineering assistance
- integration and start-up assistance
- field service
- maintenance support

### **Technical Training**

- lecture and lab courses
- self-paced computer and video-based training
- job aids and workstations
- training needs analysis

### **Repair and Exchange Services**

- your only “authorized” source
- current revisions and enhancements
- worldwide exchange inventory
- local support

**AB Parts**



Allen-Bradley, a Rockwell Automation Business, has been helping its customers improve productivity and quality for more than 90 years. We design, manufacture and support a broad range of automation products worldwide. They include logic processors, power and motion control devices, operator interfaces, sensors and a variety of software. Rockwell is one of the world's leading technology companies.



## Worldwide representation.

Argentina • Australia • Austria • Bahrain • Belgium • Brazil • Bulgaria • Canada • Chile • China, PRC • Colombia • Costa Rica • Croatia • Cyprus • Czech Republic • Denmark • Ecuador • Egypt • El Salvador • Finland • France • Germany • Greece • Guatemala • Honduras • Hong Kong • Hungary • Iceland • India • Indonesia • Ireland • Israel • Italy • Jamaica • Japan • Jordan • Korea • Kuwait • Lebanon • Malaysia • Mexico • Netherlands • New Zealand • Norway • Pakistan • Peru • Philippines • Poland • Portugal • Puerto Rico • Qatar • Romania • Russia-CIS • Saudi Arabia • Singapore • Slovakia • Slovenia • South Africa, Republic • Spain • Sweden • Switzerland • Taiwan • Thailand • Turkey • United Arab Emirates • United Kingdom • United States • Uruguay • Venezuela • Yugoslavia

Allen-Bradley Headquarters, 1201 South Second Street, Milwaukee, WI 53204 USA, Tel: (1) 414 382-2000 Fax: (1) 414 382-4444