



# FlexArmor

1798



The 1798 FlexArmor™ family is a hardened, fully modular, expandable I/O system designed to be distributed throughout your application and mounted directly on your machine. FlexArmor offers distributed I/O without the added costs of an enclosure. With its small footprint and modular construction, FlexArmor can be built and applied to its optimal ability around your application. Using the advantages of DeviceNet™ network, FlexArmor lets you effectively move data between field devices and the logic controllers.

The following FlexArmor modules are available:

I/O Modules	Baseplates	DeviceNet Field Termination Plug	Adapter Module	Filler Module
4 sinking input module (1798-IB4)	2-slot baseplate (1798-BP2)	(Micro connector (M12)) 1798-DFTP1	1798-ADN	1798-N2
8 sinking input module (1798-IB8)	4-slot baseplate (1798-BP4)	(Mini connector (M18)) 1798-DFPT2		
4 sourcing output module (1798-OB4E)	6-slot baseplate (1798-BP6)			
8 sourcing output module (1798-OB8E)	8-slot baseplate (1798-BP8)			

## Overview

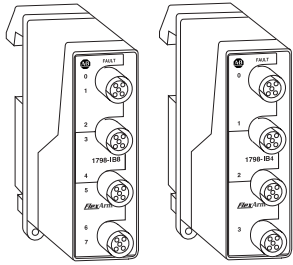

FlexArmor 24V dc Sinking Input Modules (1798-IB4 & -IB8) 42638

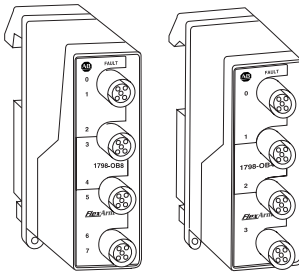

FlexArmor 24V dc Sourcing Output Modules (1798-OB4E and 1798-OB8E) 42639

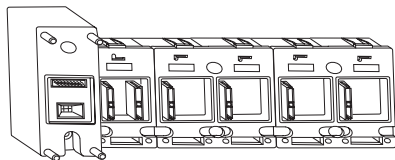

FlexArmor Baseplate (1798-BP4 shown) 42532

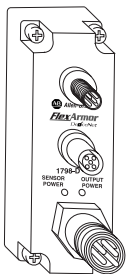

FlexArmor DeviceNet Filed Termination Plug (1798-DFTP1 or 1798-DFTP2) 42534

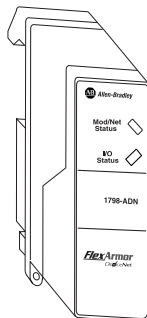

FlexArmor Adapter Module (1798-ADN) 42528

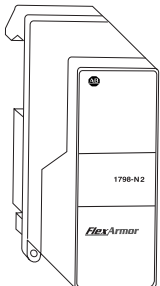

FlexArmor Filler Module (1798-N2) 42529

FlexArmor I/O provides a compact modular I/O assembly that is flexible in its physical configuration. Leveraging FLEX™ I/O technology, FlexArmor takes full advantage of diagnostic features and module removal and insertion under backplane power (RIUP) uptime. Quick-connect sealed connectors, flexible and modular construction and robust status indicators reduce commissioning time. This makes FlexArmor a highly maintainable I/O platform.

FlexArmor offers the following advantages:

- Sealed housing rated for IP67 and NEMA 4X eliminates enclosure costs.
- Modularity of I/O and network connectivity.
- Compact design of hardware lets it fit directly onto the machine.
- Locating I/O near sensors and actuators reduces wiring costs and complexity.
- Low installation cost and easy to replace without rewiring because quick-disconnect connectors are used for connection to the network, the output-circuit power supply, and each sensor or actuator.
- RIUP of any I/O module without disruption of any other modules in the system makes it possible to replace a failed module while keeping the rest of the system running.

## Features and Benefits

Feature:	Benefit:
leverages and expands on FLEX I/O technology	reuse same software tools, configuration methods, and proven FLEX I/O technology, reducing implementation time and training costs
hardened, no enclosure, and on-machine mounting	<ul style="list-style-type: none"> <li>• reduces wiring and installation costs</li> <li>• designed to handle dust, grease, oil, water, high vibration, high shock, and outdoor elements (see environmental specifications)</li> </ul>
rotary node address switches	set the module node address without using software and reduces node commissioning time
change-of-state operation	improves network throughput by reducing network bandwidth usage
<ul style="list-style-type: none"> <li>• NEMA 4X indoor/outdoor use, IP67, UV rating, -20-60°C operation,</li> <li>• quick-connect terminated cables</li> </ul>	reduces cost
<b>Versatility:</b> <ul style="list-style-type: none"> <li>• baseplates available in 2, 4, 6, and 8 slots</li> <li>• any mix of I/O up to 64 points per node</li> <li>• future integration of complementary devices (e.g., pneumatics, motor starters, etc.)</li> <li>• use virtually any 2-wire or 3-wire, IEC 1131-2 Type 1, 1+ or 2 sensor</li> </ul>	<ul style="list-style-type: none"> <li>• invest in only the I/O you need</li> <li>• can leave some slots empty for future expansion therefore reducing future installation costs</li> <li>• mix and match I/O types to run applications specific to your needs and pre-plan for future expansions</li> </ul>
<ul style="list-style-type: none"> <li>• diagnostics at point, module, network and system levels</li> <li>• visible network status and point status indicators</li> </ul>	clear indication of fault conditions magnifies productivity and maintains system uptime

Feature:	Benefit:
Remove/Insert Under Power - module, bus, and power independence	application continues to run even when a module has been removed
DeviceNet Auto Device Replace (ADR) - node is automatically re-configured when a faulted I/O module or node is replaced on the network	no re-configuration necessary when node is replaced, therefore reducing troubleshooting time
autobaud	no crashing due to incorrect baud setting
UL, CUL, CE, C-Tick	highest level of certification means this product is certified to global standards of quality, operation, performance and reliability
ODVA conformance tested	assures interoperability with other DeviceNet computer devices and systems

### Typical Configuration

This graphic shows how your FlexArmor system fits into a typical DeviceNet system.

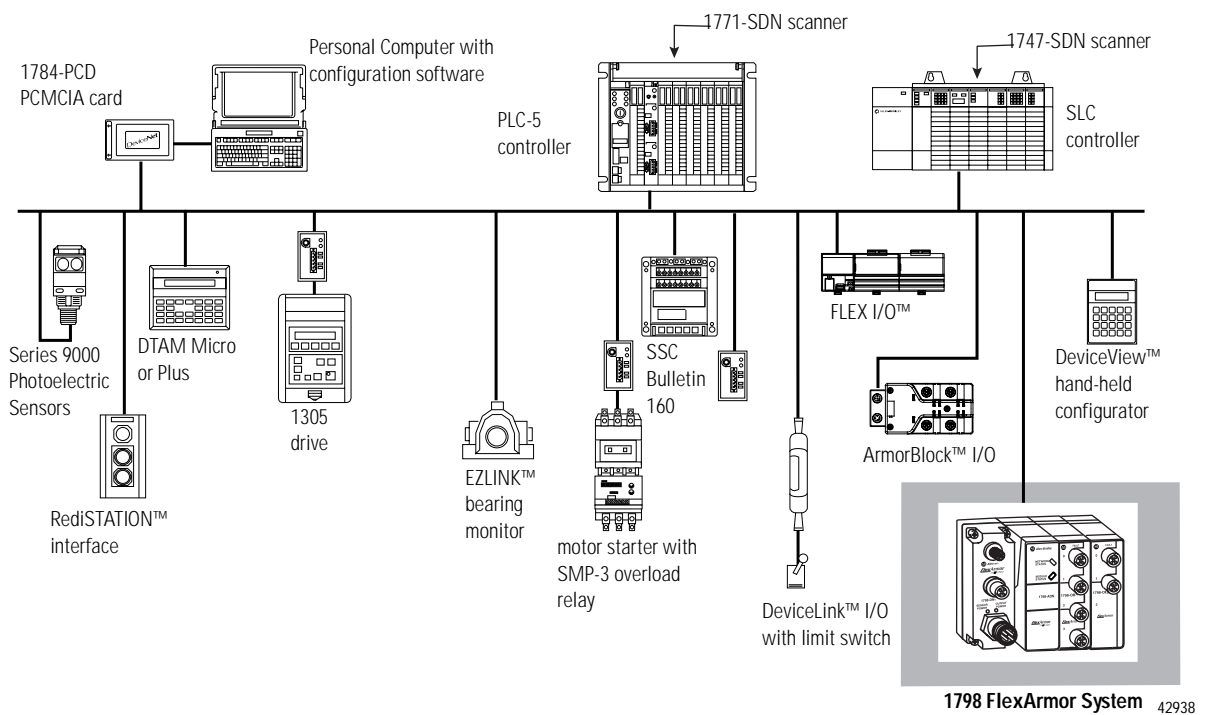

### Functional Design

FlexArmor I/O modules offer 4 or 8 points I/O each. You can plug together a maximum of 8 I/O modules into a FlexArmor I/O assembly, for a maximum of 64 I/O points per assembly. The I/O modules are interfaced to the network through an I/O adapter module with a built-in 5V dc output power supply. The I/O modules receive 5V dc logic power, 24V dc input circuit (sensor) power, and 24V dc output circuit power through the backplane.

## Mechanical Design

The FlexArmor I/O assembly is hardened and modular. I/O circuitry is packaged in I/O modules. The I/O modules of an assembly plug into a common baseplate. Baseplates are available in sizes 2, 4, 6, and 8 I/O module slots. You plug a field termination plug and an I/O adapter module into the left two slots of the baseplate. The baseplate holds the modules in place and provides the backplane for the assembly.

## About I/O Structure

Output data is received by the adapter in the order of the installed I/O modules. The Output data for slot 0 is received first, followed by the Output data for slot 1, and so on up to slot 7.

The first word of input data sent by the adapter is the Adapter Status Word. This is followed by the input data from each slot, in the order of the installed I/O modules. The Input data from slot 0 is first after the status word, following by Input data from slot 2, and so on up to slot 7.

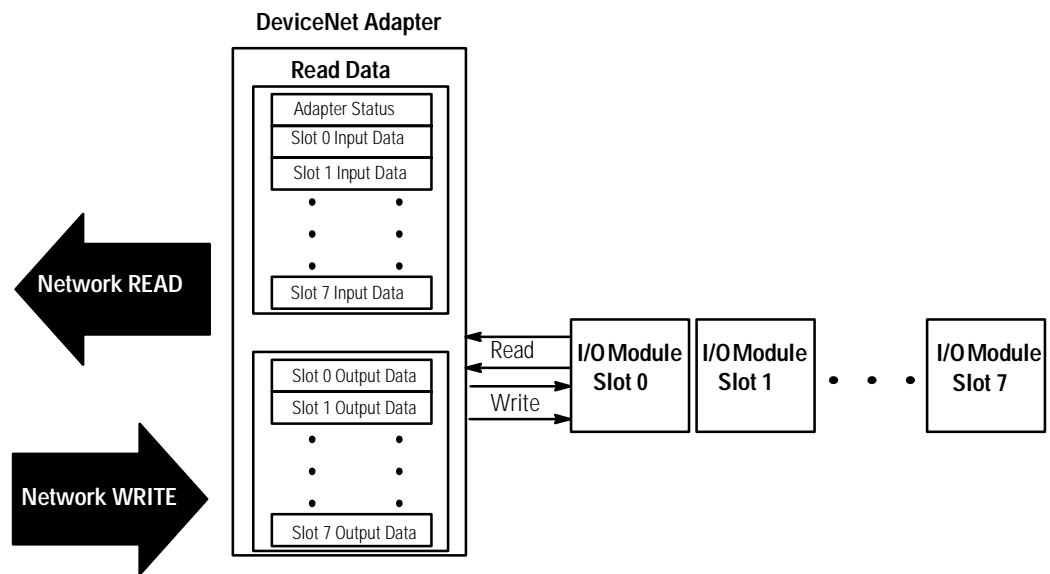

## Communication Over the FlexArmor Backplane

One 1798-ADN DeviceNet adapter can interface with up to eight FlexArmor I/O modules, forming a FlexArmor system of up to eight slots. The adapter communicates to other network system components (typically one or more controllers or scanners, and/or programming terminals) over the DeviceNet network. The adapter communicates with its I/O modules over the backplane.

## FlexArmor DeviceNet Adapter Communication Choices

The FlexArmor DeviceNet adapter module supports multiple communication choices. These choices all use the default I/O structure previously described. The adapter master makes the actual communication choice. The communication choices are selected in RSNetWorx for DeviceNet™. The choices are:

**Polled** - data is sent by the adapter in response to received data

**Strobe** - data is sent by the adapter in response to the strobe command. The single bit allocated to the adapter in the strobe message is not used. If the configured size of the input data (sent from the adapter) is greater than 8 bytes, the strobe connection establishment will fail. In this case, the input size must be re-configured to 8 bytes or less.

**Change of State** - data is sent by the adapter based on detection of any changed value within the input data. Data is independently received based on change of state from the sender. Data in both directions can be acknowledged or unacknowledged depending on the run time configuration of the system.

**Cyclic** - data is sent cyclically by the adapter based on a configured time value. Data is independently received cyclically from the sender. Data in both directions can be acknowledged or unacknowledged depending on the run time configuration of the system.

## AutoBaud Detect

The FlexArmor adapter has an AutoBaud Detect feature. The module automatically senses the baud rate of the network it is connected to and adjusts the module's communication rate accordingly.

## Status Indicators

Diagnostic indicators are located on the front of the adapter module. They show both normal operation and error conditions in your remote I/O system. The indicators are:

- Mod/Net status
- I/O status

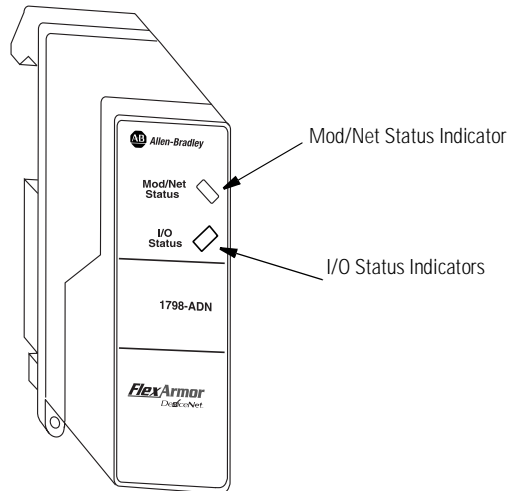

42499

The following table describes module and network status indicators.

Mod/Net Status Indicator	
Indicator	Status
Off	No power or no network access
Flashing Green/Off	On line but not connected
Solid Green	On line, link OK, connected
Flashing Red	Recoverable fault
Solid Red	Critical adapter failure

The following table describes I/O status indicators.

I/O Status Indicator	
Indicator	Status
Off	No power or outputs off
Flashing Red/Off	Recoverable fault - outputs in fault
Flashing Green/Off	Idle/program mode - outputs in idle
Solid Green	Device operational - outputs live - run
Solid Red	Critical adapter failure - unrecoverable

## Power Requirements

The FlexArmor system requires a current of 400 mA at 24V dc from the 1798-FTP sensor power connector for FLEX bus operation. This is sufficient to support up to 8 modules. Remember to add this amount to current requirements for other modules using the same 24V supply. The FlexArmor system consumes 90 mA of DeviceNet power.

## Mounting the FlexArmor Platform

The DeviceNet adapter module can be mounted directly on a machine; the FlexArmor baseplate can be mounted on a wall or panel. To mount the platform on a wall or panel, use the screw holes provided in the FlexArmor Baseplate.

25 mm (0.98 in.) clearance all around

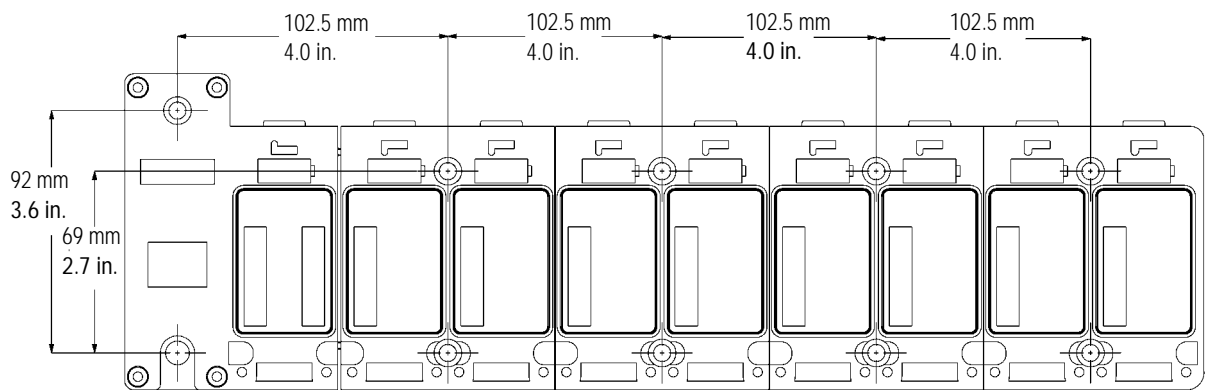

42665

## FlexArmor Connectors

The FlexArmor input and output modules use 5 pin micro (12mm) style PCB mounted connectors.

Four micro caps cover the I/O connectors on both input and output modules. Keep the caps in place on any unused connector to maintain the IP67 rating.

Refer to publication no. 889-CP0021A-EN-P for compatible Rockwell Automation cables and cordsets.

A pinout diagrams for the connectors are shown below.

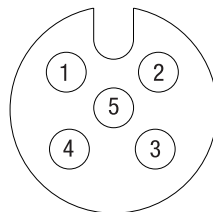

### Input Micro-Connector (View into Socket)

- Pin 1 Sensor Power
- Pin 2 Input B (IB8 module only)
- Pin 3 Sensor Common
- Pin 4 Input A
- Pin 5 Not Used - Future Use

42652

# Allen-Bradley Automation

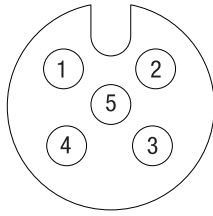

42652

**Output Micro-Connector**

(View into Socket)

- Pin 1 Not Used
- Pin 2 Output B (OB8E modules only)
- Pin 3 Output Common
- Pin 4 Output A
- Pin 5 Not Used - Future Use

**DeviceNet Field Termination Plug Wiring**

DeviceNet Field Termination Plug wiring is described below.

Connect the DeviceNet cable to the DFTP as shown.

Connect	Connector Pin	To
BLK Wire	3	-V
BLU Wire	5	CAN* Low
Bare Wire	1	Drain
WHT Wire	4	CAN High
RED Wire	2	+V

\*CAN=Controller Area Network

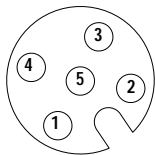

M12 Male connector (In)

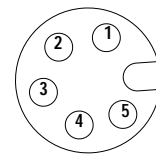

M18 Male connector (In)

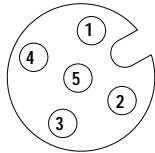

M12 Female connector (Daisy Chain Out)

42538

DFTP1

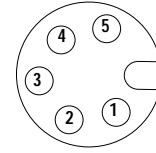

M18 Female connector (Daisy Chain In)

42653

DFTP2

**Specific Module Information**

The remainder of this publication contains specification sheets for each FlexArmor baseplate and module. Refer to the table below for information about a specific module.

For information about:	See page:
FlexArmor Baseplates (1798-BP2, 1798-BP4, 1798-BP6, 1798-BP8)	10
FlexArmor DeviceNet Field Termination Plugs (1798-DFTP1 & 1798-DFTP2)	11
FlexArmor Adapter Module (1798-ADN)	13
FlexArmor 24V dc Sinking Input Module (1798-IB4)	15
FlexArmor 24V dc Sinking Input Module (1798-IB8)	16
FlexArmor 24V dc Sourcing Output Module (1798-OB4E)	17
FlexArmor 24V dc Sourcing Output Module (1798-OB8E)	18
FlexArmor Filler Module	19



## Related Publications

Refer to the following list of publications for more information about the FlexArmor system, the DeviceNet network and its products.

<b>Title:</b>	<b>Publication Number:</b>
FlexArmor 24V dc Sinking Input Modules	1798-IN001A-EN-P
FlexArmor 24V dc Sourcing Output Modules	1798-IN002A-EN-P
FlexArmor I/O Baseplates	1798-IN003A-EN-P
FlexArmor DeviceNet Field Termination Plug	1798-IN004A-EN-P
FlexArmor Adapter Module	1798-IN006A-EN-P
FlexArmor Module (Filler)	1798-IN008A-EN-P
FlexArmor User Manual	1798-UM001A-EN-P
DeviceNet Product Overview	DN-2.5
DeviceNet Cable System Planning and Installation Manual	DN-6.7.2

## 1798-BP2, -BP4, -BP6, -BP8

The FlexArmor Baseplates provide connection points for FlexArmor communication adapters, Field Termination Plugs, I/O modules, and signal ground. The Baseplates are available with 2, 4, 6, or 8 I/O slots, depending upon your installation requirements. The completely assembled FlexArmor system requires no enclosure.

## Mount the Baseplate

To mount the Baseplate on a wall or panel, use the screw holes provided in the FlexArmor Baseplate.

A mounting illustration for the FlexArmor Baseplate is below.

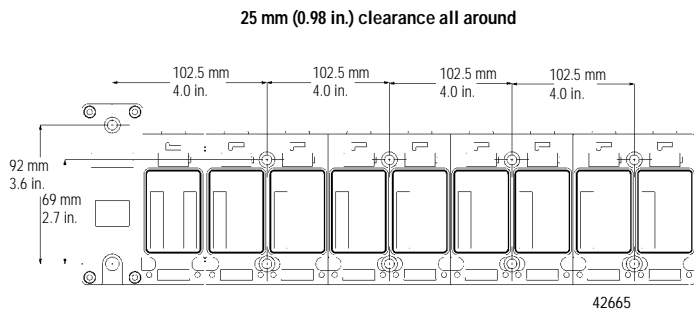

Install the mounting plate as follows:

1. Lay out the required points as shown in the drilling dimension drawing.
2. Drill the necessary holes for #10 (M6) machine or self-tapping screws.
3. Mount the Baseplate using #10 (M6) screws.
4. Provide signal ground by using the signal ground lug connection. (The signal ground lug connection is also a mounting hole.)

To view a drill template for the FlexArmor Baseplate, refer to the website:  
<http://www.ab.com/abecad/>.

## Specifications

FlexArmor Baseplates - Cat. No. 1798-BP2, -BP4, -BP6, -BP8	
General Specifications	
External Power	28.8V dc maximum
Sensor Power Bus Output Power Bus	2.5A maximum 10A maximum
Operational Temperature	-20 to 60°C (-4 to 140°F)
Storage Temperature	-40 to 85°C (-40 to 185°F)
Shock Operating	30g peak acceleration, 11(±1) ms pulse width
Non-operating	50g peak acceleration, 11(±1) ms pulse width
Vibration	Tested 5g @ 10-500 Hz per IEC 68-2-6
Enclosure	Meets IP67, NEMA 4X Outdoor Use
Agency Certification (When product is marked)	c-UL-us UL Listed Industrial Control Equipment, certified for US and Canada CE European Union 89/336/EEC EMC Directive, compliant with: EN 50081-2; Industrial Emissions EN 50082-2; Industrial Immunity EN 61131-2; Programmable Controllers C-Tick Australian Radiocommunications Act, compliant with: AS/NZS 2064; Industrial Emissions

## 1798-DFTP1 & DFTP2

The FlexArmor Field Termination Plug (Cat. No. 1798-DFTP1 & -DFTP2) serves as the user connection point for the two field power busses (sensor power and output power) as well as the DeviceNet network.

The connection point for the field power is capable of conducting a maximum of 2.5A for the Sensor Power Bus and a maximum of 10A for the Output Power Bus.

### Install the DeviceNet Field Termination Plug

To install the module:

- Mount the DFTP
- Connect external wiring

These steps are explained in more detail in the following procedures.

For instructions on how to mount the FlexArmor Baseplate, refer to publication number 1798-IN003A-EN-P.

### Mount the Field Termination Plug

To mount the Field Termination Plug:

1. Place the DFTP on the left-most slot of the Baseplate.
2. Tighten the 4 screws on the DFTP.

**IMPORTANT**

Torque the screws to 0.5-0.7 Nm. (4.43 - 6.2 inch pounds).

## Connect External Wiring

Connect external wiring to the DFTP as shown below.

1. Connect the DeviceNet cable to the DFTP as shown.

Connect	Connector Pin	To
BLK Wire	3	-V
BLU Wire	5	CAN* Low
Bare Wire	1	Drain
WHT Wire	4	CAN High
RED Wire	2	+V

\*CAN=Controller Area Network

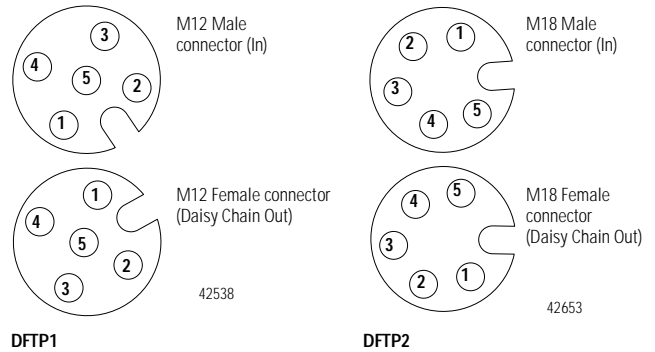

2. Insert connector into mating connector on the DeviceNet FTP module.
3. Connect 24V dc power to sensor voltage for adapter and input module power.
4. Connect 24V dc power to output voltage for output module power.

Pin	Function
1	Output Power +
2	Sensor Power +
3	Sensor Power -
4	Output Power -

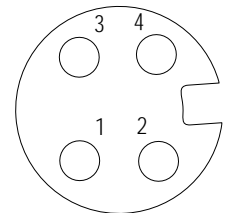

## Troubleshoot With the Indicators

The table describes status indicators on the Field Termination Plug.

Indicator	Status
Green Off	Power ON Power OFF or reverse polarity

## Specifications

Following are specifications for the DeviceNet Field Termination Plug

Voltage Rating	28.8V dc maximum
Sensor and Adapter Current	2.5A maximum
Output Current	10A maximum
Sensor/Output Voltage	10-28.8V dc
Sensor/Output Power Connector	0.875 in male 18 mm (0.71 in.)
Dimensions (H x D x W)	121 mm x 36.3 mm x 42 mm 4.75 in. x 1.43 in. x 1.65 in.
Operational Temperature	-20 to 60°C (-4 to 140°F)
Storage Temperature	-40 to 85°C (-40 to 185°F)
Shock Operating	30g peak acceleration, 11(±1) ms pulse width
Non-operating	50g peak acceleration, 11(±1) ms pulse width
Vibration	Tested 5g @ 10-500 Hz per IEC 68-2-6
Conductors	See publication DN-6.7.2
Enclosure	Meets IP67, NEMA 4X Outdoor Use
Agency Certification (When product is marked)	c-UL-us UL Listed Industrial Control Equipment, certified for US and Canada CE European Union 89/336/EEC EMC Directive, compliant with: EN 50081-2; Industrial Emissions EN 50082-2; Industrial Immunity EN 61131-2; Programmable Controllers C-Tick Australian Radiocommunications Act, compliant with: AS/NZS 2064; Industrial Emissions

## 1798-ADN

The FlexArmor DeviceNet 1798-ADN communication adapter provides the electrical interface between the network and the FlexArmor Baseplate. You must have a Field Termination Plug installed to provide the cabling interface to your network. It also provides converter functions to power all of the system side electronics for the adapter itself and the I/O modules.

### Communicate with Your FlexArmor System

Use RSNetWorx for DeviceNet 3.0 or later to configure your FlexArmor system.

The FlexArmor DeviceNet adapter module supports multiple communication choices. The network master makes the actual communication choice. These communication choices are selected in RSNetWorx for DeviceNet. The choices are:

**Polled** - data is sent by the adapter in response to received data.

**Strobe** - data is sent by the adapter in response to the strobe command. The single bit allocated to the adapter in the strobe message is not used. If the configured size of the input data (sent from the adapter) is greater than 8 bytes, the strobe connection establishment will fail. In this case, the input size must be re-configured to 8 bytes or less.

**Change of State** - data is sent by the adapter based on detection of any changed value within the input data. Data is independently received based on change of state from the sender. Data in both directions can be acknowledged or unacknowledged depending on the run time configuration of the system.

**Cyclic** - data is sent cyclically by the adapter based on a configured time value. Data is independently received cyclically from the sender. Data in both directions can be acknowledged or unacknowledged depending on the run time configuration of the system.

The adapter input status word bit descriptions are shown in the following table.

Bit Description	Bit	Explanation
I/O Module Fault	0	This bit is set (1) when an error is detected in slot position 0.
	1	This bit is set (1) when an error is detected in slot position 1.
	2	This bit is set (1) when an error is detected in slot position 2.
	3	This bit is set (1) when an error is detected in slot position 3.
	4	This bit is set (1) when an error is detected in slot position 4.
	5	This bit is set (1) when an error is detected in slot position 5.
	6	This bit is set (1) when an error is detected in slot position 6.
	7	This bit is set (1) when an error is detected in slot position 7.
Node Address Changed	8	This bit is set (1) when the node address switch setting has been changed since power up.
I/O State	9	Bit = 0 - idle Bit = 1 - run
	10 thru 15	Not used - sent as zeroes.

## Troubleshooting with the Indicators

Diagnostic indicators are located on the front of the adapter module. They show both normal operation and error conditions in your remote I/O system.

The indicators are:

- Mod/Net status
- I/O status

The following table describes module and network status indicators.

Mod/Net Status Indicator	
Indicator	Status
Off	No power or no network access
Flashing Green/Off	On line but not connected
Solid Green	On line, link OK, connected
Flashing Red	Recoverable fault
Solid Red	Critical adapter failure

The following table describes I/O status indicators.

I/O Status Indicator	
Indicator	Status
Off	No power or outputs off
Flashing Red/Off	Recoverable fault - outputs in fault
Flashing Green/Off	Idle/program mode - outputs in idle
Solid Green	Device operational - outputs live - run
Solid Red	Critical adapter failure - unrecoverable

## Specifications

Specifications	1798-ADN
External DC Power (Input Power): Voltage (24V dc nom.) Current	10-28.8V dc; 5% AC ripple 400 mA @ 24V dc
FlexBus (Output Power): Voltage (5V dc nom.) Current	4.75 - 5.2V dc; 5% AC ripple 640 mA @ 5.2V dc
Isolation Voltage (Communication Lines/System): 24V dc External Power to 5V dc FlexBus Output	850V dc for 1 second
Dimensions (H x D x W)	118 mm x 50 mm x 40 mm 4.63 in. x 1.95 in. x 1.58 in.
Environmental Conditions: Operating Temperature Storage Temperature Shock: Operating Non-Operating Vibration	-20 to 60°C (-4 to 140°F) -40 to 85°C (-40 to 185°F) 30G peak, 11±1 ms pulse width 50G peak, 11±1 ms pulse width 5G @ 10-500 Hz per IEC 68-2-6
Enclosure	Meets IP67, NEMA 4X Outdoor Use
Agency Certification (When product is marked)	c-UL-us UL Listed Industrial Control Equipment, certified for US and Canada CE European Union 89/336/EEC EMC Directive, compliant with: EN 50081-2; Industrial Emissions EN 50082-2; Industrial Immunity EN 61131-2; Programmable Controllers C-Tick Australian Radiocommunications Act, compliant with: AS/NZS 2064; Industrial Emissions ODVA ODVA conformance tested to ODVA DeviceNet specifications

## 1798-IB4 Module

The FlexArmor 1798-IB4 I/O module mounts in a FlexArmor Baseplate. Use compatible sealed cordsets to connect all field side wiring.

The 1798-IB4 module provides connections for up to 4 inputs. This module has four 12 mm connectors. Inputs are 24V dc configured for sourcing devices. A diagnostic feature includes sensor power short-circuit detection.

## Troubleshooting with the Indicators

The following table describes status indicators on digital input modules.

I/O Status Indicators		
Function	Indicator	Status
<b>Inputs</b>		
Inputs	Yellow Off	Input ON Input OFF
Fault LED	Red Off	Sensor Power Short Normal

## Connections

These modules use 5 pin micro (12mm) style PCB mounted connectors.

Four micro caps cover the I/O connectors. Remove the caps and connect your cables to the appropriate ports. Keep the caps in place on any unused connector to maintain the IP67 rating.

A pinout diagram for the connectors is shown below.

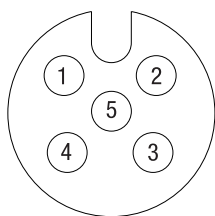

42652

**Input Micro-Connector**  
(View into Socket)

Pin 1 Sensor Power  
Pin 2 Not Used  
Pin 3 Sensor Common  
Pin 4 Input A  
Pin 5 Not Used

Refer to publication no. 889-CP0021A-EN-P for compatible Rockwell Automation cables and cordsets

## Specifications

Specifications	1798-IB4
Module Type	Digital Input, Sinking
Number of Channels	1 group of 4
Sensor Source Current	400 mA maximum
On-state Voltage	10-28.8V dc; 24V dc nominal
On-state Current	2-12 mA; 8 mA @ 24V dc
Off-state Voltage	5V dc maximum
Off-State Current	1.5 mA minimum
Channel Impedance	4.6K $\Omega$ maximum
Isolation Voltage	850V dc channel-to-system for 1s
Delay Times: Off to On On to Off	256 $\mu$ s, 512 $\mu$ s, 1 ms, 2ms 4 ms, 8 ms, 16 ms, 32 ms (Selectable; 256 $\mu$ s default)
FlexBus Current	20 mA maximum
Power Dissipation	2.0W @ 28.8V dc
Thermal Dissipation	6.8 BTU/hr. @ 28.8V dc
Indicators	4 channel status - yellow 1 fault LED indicator- red
External DC Power Voltage (24V dc nom.) Current	10-28.8V dc; 5% AC ripple 450 mA maximum
Dimensions (H x D x W)	118 mm x 57 mm x 40 mm 4.63 in. x 2.25 in. x 1.58 in.
Environmental Conditions: Operating Temperature Storage Temperature Shock: Operating Non-Operating Vibration	-20 to 60°C (-4 to 140°F) -40 to 85°C (-40 to 185°F) 30G peak, 11 $\pm$ 1 ms pulse width 50G peak, 11 $\pm$ 1 ms pulse width 5G @ 10-500 Hz per IEC 68-2-6
Conductors	See publication DN-6.7.2
Enclosure	Meets IP67, NEMA 4X Outdoor Use
Agency Certification (When product is marked)	c-UL-us UL Listed Industrial Control Equipment, certified for US and Canada CE European Union 89/336/EEC EMC Directive, compliant with: EN 50081-2; Industrial Emissions EN 50082-2; Industrial Immunity EN 61131-2; Programmable Controllers C-Tick Australian Radiocommunications Act, compliant with: AS/NZS 2064; Industrial Emissions

# Allen-Bradley Automation

## 1798-IB8 Module

The FlexArmor 1798-IB8 I/O module mounts in a FlexArmor Baseplate. Use compatible sealed cordsets to connect all field side wiring.

The 1798-IB8 module provides connections for up to 8 inputs. This module has four 12 mm connectors. Inputs are 24V dc configured for sourcing devices. A diagnostic feature includes sensor power short-circuit detection.

## Troubleshooting with the Indicators

The following table describes status indicators on digital input modules.

I/O Status Indicators		
Function	Indicator	Status
<b>Inputs</b>		
Inputs	Yellow Off	Input ON Input OFF
Fault LED	Red Off	Sensor Power Short Normal

## Connections

These modules use 5 pin micro (12mm) style PCB mounted connectors.

Four micro caps cover the I/O connectors. Remove the caps and connect your cables to the appropriate ports. Keep the caps in place on any unused connector to maintain the IP67 rating.

A pinout diagram for the connectors is shown below.

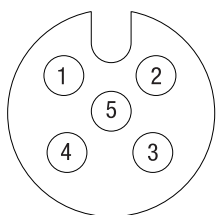

42652

**Input Micro-Connector**  
(View into Socket)  
Pin 1 Sensor Power  
Pin 2 Input B  
Pin 3 Sensor Common  
Pin 4 Input A  
Pin 5 Not Used

Refer to publication no. 889-CP0021A-EN-P for compatible Rockwell Automation cables and cordsets.

## Specifications

Specifications	1798-IB8
Module Type	Digital Input, Sinking
Number of Channels	1 group of 8
Sensor Source Current	400 mA maximum
On-state Voltage	10-28.8V dc; 24V dc nominal
On-state Current	2-12 mA; 8 mA @ 24V dc
Off-state Voltage	5V dc maximum
Off-State Current	1.5 mA minimum
Channel Impedance	4.6KΩ maximum
Isolation Voltage	850V dc channel-to-system for 1s
Delay Times: Off to On On to Off	256 us, 512 us, 1 ms, 2ms 4 ms, 8 ms, 16 ms, 32 ms (Selectable; 256 us default)
FlexBus Current	20 mA maximum
Power Dissipation	3.0W @ 28.8V dc
Thermal Dissipation	10.2 BTU/hr. @ 28.8V dc
Indicators	8 channel status - yellow 1 fault LED indicator - red
External DC Power Voltage (24V dc nom.) Current	10-28.8V dc; 5% AC ripple 500 mA maximum
Dimensions (H x D x W)	118 mm x 57 mm x 40 mm 4.63 in. x 2.25 in. x 1.58 in.
Environmental Conditions: Operating Temperature Storage Temperature Shock: Operating Non-Operating Vibration	-20 to 60°C (-4 to 140°F) -40 to 85°C (-40 to 185°F) 30G peak, 11±1 ms pulse width 50G peak, 11±1 ms pulse width 5G @ 10-500 Hz per IEC 68-2-6
Conductors	See publication DN-6.7.2
Enclosure	Meets IP67, NEMA 4X Outdoor Use
Agency Certification (When product is marked)	c-UL-us UL Listed Industrial Control Equipment, certified for US and Canada CE European Union 89/336/EEC EMC Directive, compliant with: EN 50081-2; Industrial Emissions EN 50082-2; Industrial Immunity EN 61131-2; Programmable Controllers C-Tick Australian Radiocommunications Act, compliant with: AS/NZS 2064; Industrial Emissions



## 1798-OB4E Module

The FlexArmor 1798-OB4E I/O module mounts in a FlexArmor Baseplate. Use compatible sealed cordsets to connect all field side wiring.

The 1798-OB4E module provides connections for up to 4 outputs. This module has four 12 mm connectors. Outputs are 24V dc configured for sinking devices. A diagnostic feature includes output short-circuit detection.

## Troubleshooting with the Indicators

The following table describes status indicators on digital output modules.

I/O Status Indicators		
Function	Indicator	Status
<b>Inputs</b>		
Outputs	Yellow Off	Output ON Output OFF
Fault LED	Red Off	One or more outputs shorted Normal

## Connections

These modules use 5 pin micro (12mm) style PCB mounted connectors.

Four micro caps cover the I/O connectors. Remove the caps and connect your cables to the appropriate ports. Keep the caps in place on any unused connector to maintain the IP67 rating.

A pinout diagram for the connectors is below.

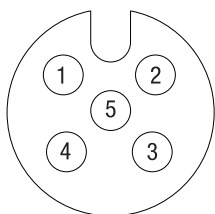

42652

**Output Micro-Connector**  
(View into Socket)

- Pin 1 Not Used
- Pin 2 Not Used
- Pin 3 Output Common
- Pin 4 Output A
- Pin 5 Not Used

Refer to publication no. 889-CP0021A-EN-P for compatible Rockwell Automation cables and cordsets.

## Specifications

Specifications	1798-OB4E
Module Type	Digital Output, Sourcing
Number of Channels	1 group of 4
On-state Voltage	10-28.8V dc; 24V dc nominal
On-state Current (per channel)	1.0A per channel
On-state Current (per module)	4.0A per module
Off-state Voltage	28.8V dc maximum
Off-State Current	0.5 mA maximum leakage
On-State Voltage Drop	0.5V dc maximum drop
Surge Current	2.0A for 50 ms (Repeatable every 2 seconds)
Isolation Voltage	850V dc for 1 second
Delay Times: Off to On On to Off	0.5 ms maximum 1.0 ms maximum
FlexBus Current	60 mA maximum
Power Dissipation	2.4 W @ 28.8 V dc
Thermal Dissipation	8.2 BTU/hr. @ 28.8V dc
Indicators	4 channel status - yellow 1 fault LED indicators- red
External DC Power Voltage (24V dc nom.) Current	10-28.8V dc; 5% AC ripple 4.0A maximum
Dimensions (H x D x W)	118 mm x 57 mm x 40 mm 4.63 in. x 2.25 in. x 1.58 in.
Environmental Conditions: Operating Temperature Storage Temperature Shock: Operating Non-Operating Vibration	-20 to 60°C (-4 to 140°F) (see graph below) -40 to 85°C (-40 to 185°F) 30G peak, 11±1ms pulse width 50G peak, 11±1ms pulse width 5G @ 10-500Hz per IEC 68-2-6
Conductors	See publication DN-6.7.2
Cordsets	5 pin micro (12mm) style connectors
Enclosure	Meets IP67, NEMA 4X Outdoor Use
Agency Certification (When product is marked)	c-UL-us UL Listed Industrial Control Equipment, certified for US and Canada CE European Union 89/336/EEC EMC Directive, compliant with: EN 50081-2; Industrial Emissions EN 50082-2; Industrial Immunity EN 61131-2; Programmable Controllers C-Tick Australian Radiocommunications Act, compliant with: AS/NZS 2064; Industrial Emissions

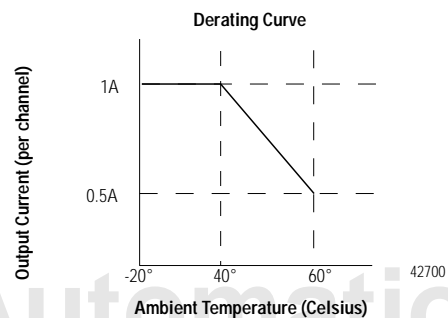

## 1798-OB8E Module

The FlexArmor 1798-OB8E I/O module mounts in a FlexArmor Baseplate. Use compatible sealed cordsets to connect all field side wiring.

The 1798-OB8E module provides connections for up to 8 outputs. This module has four 12 mm connectors. Outputs are 24V dc configured for sinking devices. A diagnostic feature includes output short-circuit detection.

## Troubleshooting with the Indicators

The following table describes status indicators on digital output modules.

I/O Status Indicators		
Function	Indicator	Status
<b>Inputs</b>		
Outputs	Yellow Off	Output ON Output OFF
Fault LED	Red Off	One or more outputs shorted Normal

## Connections

These modules use 5 pin micro (12mm) style PCB mounted connectors.

Four micro caps cover the I/O connectors. Remove the caps and connect your cables to the appropriate ports. Keep the caps in place on any unused connector to maintain the IP67 rating.

A pinout diagram for the connectors is below.

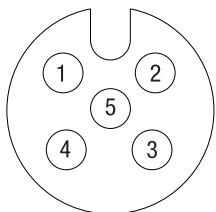

42652

**Output Micro-Connector**  
(View into Socket)

- Pin 1 Not Used
- Pin 2 Output B
- Pin 3 Output Common
- Pin 4 Output A
- Pin 5 Not Used

Refer to publication no. 889-CP0021A-EN-P for compatible Rockwell Automation cables and cordsets.

## Specifications

Specifications	1798-OB8E
Module Type	Digital Output, Sourcing
Number of Channels	1 group of 8
On-state Voltage	10-28.8V dc; 24V dc nominal
On-state Current (per channel)	1.0A per channel
On-state Current (per module)	5.0A per module
Off-state Voltage	28.8V dc maximum
Off-State Current	0.5 mA maximum leakage
On-State Voltage Drop	0.5V dc maximum drop
Surge Current	2.0A for 50 ms (Repeatable every 2 seconds)
Isolation Voltage	850V dc for 1 second
Delay Times: Off to On On to Off	0.5 ms maximum 1.0 ms maximum
FlexBus Current	60 mA maximum
Power Dissipation	2.9 W @ 28.8 V dc
Thermal Dissipation	9.9 BTU/hr. @ 28.8V dc
Indicators	8 channel status - yellow 1 fault LED indicators- red
External DC Power Voltage (24V dc nom.) Current	10-28.8V dc; 5% AC ripple 5.0A maximum
Dimensions (H x D x W)	118 mm x 57 mm x 40 mm 4.63 in. x 2.25 in. x 1.58 in.
Environmental Conditions: Operating Temperature Storage Temperature Shock: Operating Non-Operating Vibration	-20 to 60°C (-4 to 140°F) (see graph below) -40 to 85°C (-40 to 185°F) 30G peak, 11±1ms pulse width 50G peak, 11±1ms pulse width 5G @ 10-500Hz per IEC 68-2-6
Conductors	See publication DN-6.7.2
Cordsets	5 pin micro (12mm) style connectors
Enclosure	Meets IP67, NEMA 4X Outdoor Use
Agency Certification (When product is marked)	c-UL-us UL Listed Industrial Control Equipment, certified for US and Canada CE European Union 89/336/EEC EMC Directive, compliant with: EN 50081-2; Industrial Emissions EN 50082-2; Industrial Immunity EN 61131-2; Programmable Controllers C-Tick Australian Radiocommunications Act, compliant with: AS/NZS 2064; Industrial Emissions

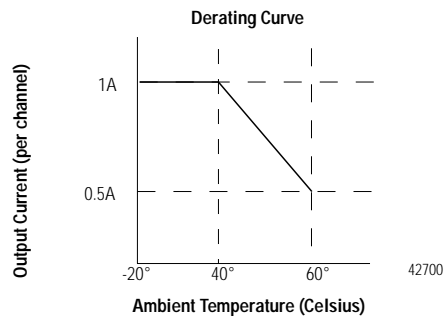

## 1798-N2

The FlexArmor 1798-N2 module mounts in a FlexArmor Baseplate. It covers unused I/O module slots to maintain IP67 enclosure integrity.

### Install the Modules into the Baseplate

To install the modules into the Baseplate:

1. Hold the N2 module at an angle and engage the top of the module in the indentation on the rear of the Baseplate.
2. Press the module down flush with the panel until the locking lever locks.
3. Screw down the module retaining screws to ensure IP67 compliance.

#### IMPORTANT

Torque the screws to 0.5-0.7 Nm.  
(4.43 - 6.2 inch pounds).

## Specifications

### N2 Module Specifications

Specifications	1798-N2
Module Type	Dummy
Dimensions (H x D x W)	118 mm X 50 mm X 40 mm 4.63 in. X 1.95 in. X 1.58 in.
Enclosure	Meets IP67, NEMA 4X Outdoor Use
Agency Certification (When product is marked)	c-UL-us UL Listed Industrial Control Equipment, certified for US and Canada CE European Union 89/336/EEC EMC Directive, compliant with: EN 50081-2; Industrial Emissions EN 50082-2; Industrial Immunity EN 61131-2; Programmable Controllers C-Tick Australian Radiocommunications Act, compliant with: AS/NZS 2064; Industrial Emissions

# Allen-Bradley Automation

Allen-Bradley is a registered trademark of Rockwell Automation.  
FlexArmor is a trademark of Rockwell Automation, Allen-Bradley Inc.  
FLEX I/O, EZLINK, DeviceView, DeviceLink, ArmorBlock, and RediSTATION are trademarks of Rockwell Automation.  
DeviceNet is a trademark of Open DeviceNet Vendor Association (ODVA).  
RSNetWorx for DeviceNet is a trademark of Rockwell Software, Inc.

**[www.rockwellautomation.com](http://www.rockwellautomation.com)**

---

**Power, Control and Information Solutions Headquarters**

Americas: Rockwell Automation, 1201 South Second Street, Milwaukee, WI 53204-2496 USA, Tel: (1) 414.382.2000, Fax: (1) 414.382.4444

Europe/Middle East/Africa: Rockwell Automation, Vorstlaan/Boulevard du Souverain 36, 1170 Brussels, Belgium, Tel: (32) 2 663 0600, Fax: (32) 2 663 0640

Asia Pacific: Rockwell Automation, Level 14, Core F, Cyberport 3, 100 Cyberport Road, Hong Kong, Tel: (852) 2887 4788, Fax: (852) 2508 1846