

Bulletin 190 — IEC Modular Starter System

Table of Contents

Selection Guide

Description	Page
Bulletin 190	2
Accessories	7
Specifications	10
Approximate Dimensions	19

Bulletin 190

- Manual Interrupter — 40A
- Interchangeable Trip Units — 11 Ranges to 40A
- Contactor Module — 40A, 20kW @ 415V AC, Current Limiting Contact Structure
- Coordinated Protected Starter (Applicable in North America Only)
- Operating Handle Indicates “ON”, “OFF” and “TRIPPED”
- Visible Isolation Gap with Trip Unit Removed
- Short Circuit Trip Setting Dial
- Overload Trip Setting Dial
- Sealable Cover for Trip Setting Dials
- Operating Handle Can Be Padlocked “OFF”
- Type 2 Coordination with Integrated and Coordinated Protected Starters



TABLE OF CONTENTS

Description	Page	Description	Page
Product Selection	3	Specification	10
Accessories	7	Approximate Dimensions	19

Description

Bulletin 190 Modular Starter System is a family of modular components that are assembled into a series of high performance motor starters. These starters reduce machine or process down time by lessening or eliminating component damage caused by short circuit current.

Conformity to Standards:

IEC 947-2, 947-4-1, 204-1, 364

VDE 0100, 0106 Parts 101, 0110, 0113,
0660 Parts 101, 102, 104, 107

CSA C22.2 No. 14

UL 508

UL Listed for Group Motor installation

Approvals:

CE

CSA Certified





UL Listed

Your order must include:

- The Cat. No. of the manual interrupter, contactor module, trip unit, operating handle adapter, or operating shaft.
- The Cat. No. of any accessories required.

System Circuit Breaker (To IEC 947-2) for Protection of Cables and Wiring ❶

Note: Not for use in North America.

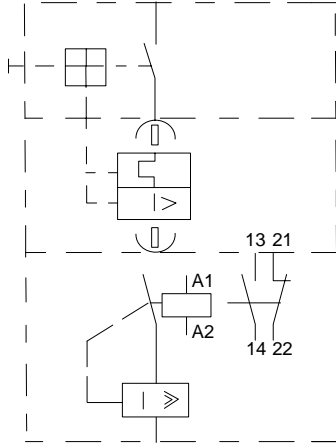
	Description	Cat. No.																		
 Manual Interrupter Cat. No. 190-MN	ORDER Manual Interrupter 40A I_e 690V.	190-MN																		
 + Trip Unit for System Protection Cat. No. 190-P100L	ALSO ORDER Thermal Magnetic Trip Unit for System Protection (Short Circuit trip = $5 - 8.5 \times I_U$) <table border="1" style="margin-left: auto; margin-right: auto; border-collapse: collapse;"> <thead> <tr> <th style="width: 30%;">Adjustable Thermal Current Range (A)</th> <th style="width: 30%;">Adjustable Magnetic Trip Current Range (A)</th> <th style="width: 40%;"></th> </tr> </thead> <tbody> <tr> <td>6...10</td> <td>50...80</td> <td>190-P100L</td> </tr> <tr> <td>10...16</td> <td>80...140</td> <td>190-P160L</td> </tr> <tr> <td>16...25</td> <td>130...210</td> <td>190-P250L</td> </tr> <tr> <td>24...32</td> <td>160...280</td> <td>190-P320L</td> </tr> <tr> <td>32...40</td> <td>200...350</td> <td>190-P400L</td> </tr> </tbody> </table>	Adjustable Thermal Current Range (A)	Adjustable Magnetic Trip Current Range (A)		6...10	50...80	190-P100L	10...16	80...140	190-P160L	16...25	130...210	190-P250L	24...32	160...280	190-P320L	32...40	200...350	190-P400L	
Adjustable Thermal Current Range (A)		Adjustable Magnetic Trip Current Range (A)																		
6...10		50...80	190-P100L																	
10...16		80...140	190-P160L																	
16...25		130...210	190-P250L																	
24...32	160...280	190-P320L																		
32...40	200...350	190-P400L																		
 = Circuit Breaker ❶	ORDER Contactor Module or Current Limiter Module	190-A40 ⊗																		
 + Contactor Module or Current Limiter Module Cat. No. 190-A40⊗ or Cat. No. 190-CL1		190-CL1																		
 = Combination Circuit Breaker ❶	Schematic Symbol																			
																				

⊗ **Voltage Suffix Code**

The Cat. No. as listed is incomplete. Select a Voltage Suffix Code from the table below to complete the Cat. No. Example: **Cat. No. 190-A40**⊗ become **Cat. No. 190-A40** .

Voltage	24V	110V	120V	208V	220V	240V	380V	415V	440V	480V	600V
50 Hz	K	D	–	–	A	–	N	B	B	–	–
60 Hz	J	–	D	H	–	A	–	–	G	B	C
DC	Z										





❶ The Bulletin 190 System Circuit Breaker and Combination Circuit Breaker cannot be utilized as a short circuit protective device in Canadian and U.S. applications. In order to be utilized as circuit breaker in Canadian and U.S. applications, the device would have to meet the breaker requirements of CSA and UL respectively. The Bulletin 190 System Combination Circuit Breaker does not meet these requirements.

Accessories — Page 7

Specifications — Page 10



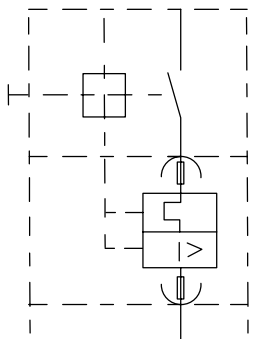

Approximate Dimensions — Page 19

Manual Motor Starter and Protector ①

		Description		Cat. No.	
 Manual Interrupter Cat. No. 190-MN  Trip Unit Cat. No. 190-P_ _ _ or  Trip Unit Cat. No. 190-P_ _ _ R  Manual Motor Starter and Protector	ORDE	Manual Interrupter 40 AMP I_e 690 V U_i		190-MN	
	ALSO ORDER	Trip Unit	Adjustable Thermal Current Range (A)	Adjustable Magnetic Trip Current Range (A)	
			0.4...0.6	5...8	190-P006
			0.6...1.0	8...14	190-P010
			1.0...1.6	14...22	190-P016
			1.6...2.4	20...35	190-P024
			2.4...4	35...55	190-P040
			4...6	50...80	190-P060
			6...10	80...140	190-P100
			10...16	130...22	190-P160
			16...27	200...35	190-P250
		24...32	275...42	190-P320	
		32...42	350...50	190-P400	
	OR ALSO ORDE	Trip Unit with Relay Contacts — 1 N.O. and 1 N.C. Suitable for use with Bulletin 190-MN or Bulletin 190-CPS40D. Overload condition changes contact state. Usually wired to de-energize contactor coil on overload condition. Interrupter opens on short circuit only. Note: This trip unit not compatible with 190 RC Remote Operators, 190 RT Shunt Trip, or 190 UV Undervoltage Trip Modules.	0.4...0.6	5...8	190-P006R
	0.6...1.0		8...14	190-P010R	
	1.0...1.6		14...22	190-P016R	
	1.6...2.4		20...35	190-P024R	
	2.4...4		35...55	190-P040R	
	4...6		50...80	190-P060R	
	6...10		80...140	190-P100R	
	10...16		130...22	190-P160R	
	16...27		200...35	190-P250R	
	24...32		275...42	190-P320R	
	32...42	350...50	190-P400R		
Schematic without Relay Contacts:					
					

① **UL Listed Components** — The Bulletin 190 manual motor starter/protector is CSA Certified and UL Listed. Suitable for use on a circuit capable of delivering 42 kA RMS SYM/600V or 65 kA RMS SYM/480V when protected by fuses or circuit breaker selected in accordance with the U.S. National Electrical Code.

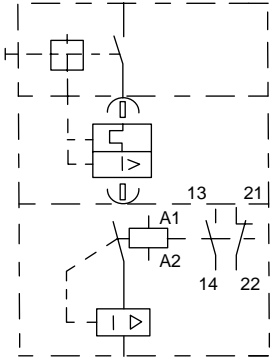
Integrated Starter ①

		Description				Cat. No.
		ORDER	Manual Interrupter			190-MN
 Manual Interrupter Cat. No. 190-MN		ORDER	Contactor Module			190-A40 ⊗
		ALSO ORDER	Trip Unit ⊕	Adjustable Thermal Current Range (A)	Adjustable Magnetic Trip Current Range (A)	Cat. No.
 + Contactor Module Cat. No. 190-A40⊗				0.4...0.6	5...8	190-P006
				0.6...1.0	8...14	190-P010
				1.0...1.6	14...22	190-P016
				1.6...2.4	20...35	190-P024
				2.4...4	35...55	190-P040
				4...6	50...80	190-P060
				6...10	80...140	190-P100
				10...16	130...220	190-P160
				16...27	200...350	190-P250
				24...32	275...425	190-P320
32...42	350...500	190-P400				
 + Trip Unit Cat. No. 190-P___		Schematic without Relay Contacts:				
						
 = Integrated Starter						

⊗ **Voltage Suffix Code**

The Cat. No. as listed is incomplete. Select a Voltage Suffix Code from the table below to complete the Cat. No. Example: **Cat. No. 190-A40⊗** become **Cat. No. 190-A40J**.

Voltage	24V	110V	120V	208V	220V	240V	380V	415V	440V	480V	600V
50 Hz	K	D	—	—	A	—	N	B	B	—	—
60 Hz	J	—	D	H	—	A	—	—	G	B	C
DC	Z										

① **UL Listed Components** — The Bulletin 190 Integrated Starter is CSA Certified and UL Listed. Suitable for use on a circuit capable of delivering not more than 42,000A. RMS Symmetrical at 600V AC, or 65,000A. RMS Symmetrical at 480V AC when protected by fuses or circuit breaker selected in accordance with the requirements of the U.S. National Electrical Code.





⊕ A Trip Unit with Relay Contacts (1 N.O. and 1 N.C.) may be ordered.

Accessories — Page 7
 Specifications — Page 10
 Approximate Dimensions — Page 19

Bulletin 190
IEC Modular Starter System
 Product Selection, Continued

Coordinated Protected Starter — North American Markets On y ①

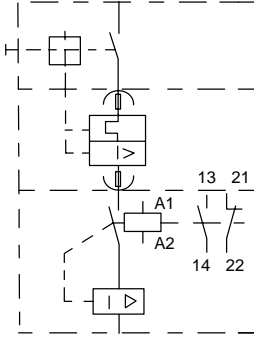
Meets CSA and UL Requirements for a Combination Starter.

		Description		Cat. No.	
 Coordinated Protected Starter Less Trip Unit Cat. No. 190-CPS40⊗	ORDER	Coordinated protected starter less trip unit		190-CPS40⊗ ②	
	OR ORDER	Reversing coordinated protected starter less trip unit		190R-CPS40⊗ ②	
	ALSO ORDER	Trip Unit ③	Adjustable Thermal Current Range (A)	Adjustable Magnetic Trip Current Range (A)	
			0.4...0.6	5...8	190-P006
			0.6...1.0	8...14	190-P010
			1.0...1.6	14...22	190-P016
			1.6...2.4	20...35	190-P024
			2.4...4	35...55	190-P040
			4...6	50...80	190-P060
			6...10	80...140	190-P100
10...16			130...220	190-P160	
16...27			200...350	190-P250	
24...32	275...425	190-P320			
32...42	350...500	190-P400			
 Trip Unit Cat. No. 190-P					
 = Coordinated Protected Starter					

⊗ **Voltage Suffix Code**

The Cat. No. as listed is incomplete. Select a Voltage Suffix Code from the table below to complete the Cat. No. Example: **Cat. No. 190-CPS40⊗** becomes **Cat. No. 190-CPS40** .

Voltage	24V	110V	120V	208V	220V	240V	380V	415V	440V	480V	600V
50 Hz	K	D	—	—	A	—	N	B	B	—	—
60 Hz	J	—	D	H	—	A	—	—	G	B	C
DC	Z										

① **CSA Certified and UL Listed** — Suitable for use on a circuit capable of delivering 100,000 amperes RMS SYM at 240V, 65,000 amperes RMS SYM at 480V or 42,000 amperes RMS SYM at 600V. **Note:** Ratings above 240V are based on Power Systems as follows: 480Y/277V AC; 600Y/347V AC (up through 190-P250) to the line side of this starter.

② 60 Hz only.

③ A Trip Unit with Relay Contacts (1 N.O. and 1 N.C.) may be ordered.

Accessories — Page 7

Specifications — Page 10

Approximate Dimensions — Page 19

Auxiliary Contacts ❶

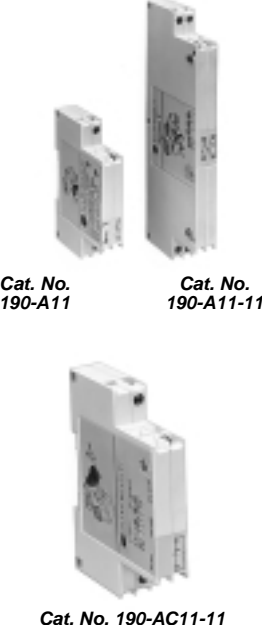
	Mounting	Configuration	Pkg. Qty.	Cat. No.
 <p>Cat. No. 190-A11 Cat. No. 190-A11-11</p> <p>Cat. No. 190-AC11-11</p>	Manual Interrupter	1 N.O., 1 N.C., Operate with interrupter	1	190-A11
		2 N.O., 2 N.C., Operate with interrupter		190-A22
	Integrated Starters OR Coordinated Protected Starter	1 N.O., 1 N.C., Operate with interrupter	1	190-A11C
		2 N.O., 2 N.C., Operate with interrupter		190-A22C
		1 N.O., 1 N.C., Operate with interrupter; 1 N.O., 1 N.C., Operate with contactor		190-A11-11
	Contactor (when separately mounted) ❶	1 N.O., 1 N.C	1	190-AC11-11

Trip Indicating Contacts ❶







	Mounting	Configuration	Pkg. Qty.	Cat. No.
	Manual Interrupter	1 N.O., 1 N.C., Indicate short circuit; 1 N.O., 1 N.C., Indicate overload	1	190-T11-11

Three Phase Commoning Link

	Description	Pkg. Qty.	Cat. No.
	For line side connection of adjacent manual interrupters. 100A. (Sufficient room between units for auxiliary contacts, shunt trip or undervoltage trip module is provided.)	1	190-L13
	Three Phase Link Terminal — (Not shown.) For use with commoning link above.	1	190-L2



❶ 1 N.O., 1 N.C. internal auxiliary contacts furnished standard with the contactor module.

Modules/Adaptors



	Description	Pkg. Qty.	Cat. No.
	Shunt Trip Module — Trips manual interrupter from a remote location using voltage signal. Coils available (multi-voltage):	1	
	24...48V 50/60 Hz 24...60V DC		190-RT048
	110...250V 50/60 Hz 110...250V DC		190-RT250
	380...600V 50/60 Hz 380...600V DC		190-RT600
	Undervoltage Trip Module — Trips manual interrupter on power loss (70...35 V). Prevents undesired restart upon power resumption. (Undervoltage protection) Coils available (multi-voltage):	1	
	24V 50/60 Hz		190-UV024
	110V 50 Hz, 120V 60 Hz		190-UV120
	220V 50 Hz, 240V 60 Hz		190-UV240
	415/440V 50 Hz, 480V 60 Hz		190-UV480
	500V 50 Hz, 600V 60 Hz		190-UV600
	208V 60 Hz		190-UV208
	380V 50 Hz		190-UV380
	Remote Operator Module ① — Operates manual interrupter from a remote location using a voltage signal. Provides 'ON,' 'OFF,' and 'RESET' functions. Includes a lockout provision. 50,000 operations life.	1	
	Signalled and powered at same voltage		
	110...120V AC/DC		190-RCE120
	220...250V AC/DC		190-RCE230
	380...415V AC		190-RCE400
	440V AC		190-RCE440
	Signalled at 24V AC or DC. Powered at separate voltages shown below.		
	24V AC/DC		190-RCS24
	48V AC/DC		190-RCS48
	110...120V AC/DC		190-RCS120
	220...240V AC/DC		190-RCS230
	380...415V AC		190-RCS400
	440V AC		190-RCS440
			Separate Mounting Base for Contactor Module — Provides line side terminals and mounting provisions. Allows panel design flexibility by offering the option of side or separate mounting of the contactor.
	Amplifier Module — For programmable controller interfacing.	1	
	Input: 24V DC, 15mA		190-N3
	48V DC, 10mA		190-N4
	125V DC, 10mA		190-N5
Output: 1 N.O. and 1 N.C. contacts, 2A at 415V AC11 or 0.11A at 240V DC-DC11		2	190-N1
	Adaptor — Allows an integrated starter to be DIN rail mounted.		

① The use of an auxiliary contact with the manual interrupter is recommended.

Coding Pin/Surge Suppressor

	Description	Pkg. Qty.	Cat. No.
	Coding Pin — Inhibits insertion of the incorrect trip unit into the manual interrupter.	5	190-N7
	Surge Suppressor — Suitable for use with 120V contactor modules.	1	199-FSMA1

External Operating Handle for Enclosure Cover Mounting ①

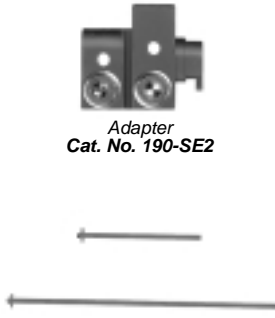
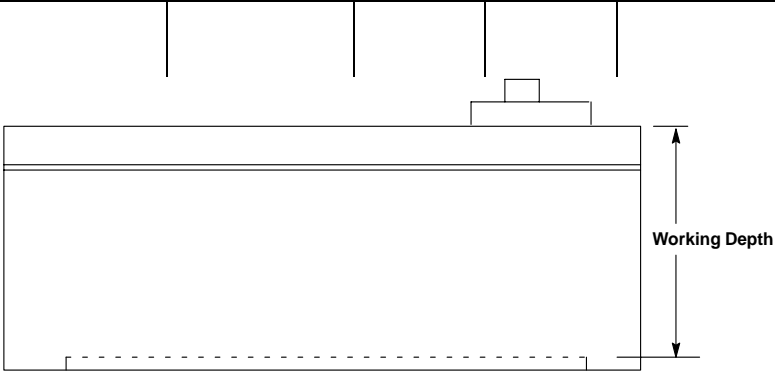
	IP42 (Type 1)		IP66 (Type 3, 3R, 4, 4X & 12)	
	Color	Cat. No.	Color	Cat. No.
	 <i>Operating Handle</i>	Black	190-HS1	Black
	Red/Yellow	190-HS1E	Red/Yellow	190-HS4E
 + <i>Adapter</i> <i>Cat. No. 190-SE-1</i> <i>or</i>	Adapter and Operating Shaft			
 + <i>Operating Shaft</i>	Working Depth mm (inches)		Adapter	
	Minimum	Maximu	Operating Shaft	
			Cat. No.	
			Cat. No.	
	When Cat. No. 190-N1 Mounting Plate Is Used			
	161 (6-11/32)	175 (6-57/64)	190-SE1	⊘
	176 (6-15/16)	303 (11-15/16)	190-SE2	194R-R
	305 (12)	497 (19-9/16)	190-SE2	194R-R
	When Cat. No. 190-N1 Mounting Plate Is Not Used			
	152 (6)	166 (6-17/32)	190-SE1	⊘
	167 (6-9/16)	294 (11-9/16)	190-SE2	194R-R
	295 (11-5/8)	488 (19-7/32)	190-SE2	194R-R
				

- ① Not compatible with use of "Remote Operator Module".
- ② An operating shaft may be required depending on the working depth of the enclosure. Working depth is measured from the front of the enclosure to the panel on which the Bulletin 190 starter is mounted (see drawing). This depth determines if an adapter is required and which adapter, or adapter and operating shaft, is to be used. Order an adapter and operating shaft as indicated in the table.

Bulletin 190
IEC Modular Starter System
Specifications

Short-Circuit Switching Capacity

The following information is not for use in Canadian and U.S. Applications.

<p>190-MN Manual Interrupter + 190-P Trip Unit</p>	006	010	016	024	040
Adjustable Thermal Current (A)	0.4...0.6	0.6...1.0	1.0...1.6	1.6...2.4	2.4...4.0
Adjustable Magnetic Trip Range (A)	5...8	8...14	14...22	20...35	35...55

Switching Capacity (kA)

190-MN + 190-P__ switching capacity Icn P-1/P-2 (kA)	220/380/415V	50 H	∞	∞	∞	∞	∞
	440V	50 H	∞	∞	∞	∞	∞
	500V	50 H	∞	∞	∞	∞	∞
	660/690V	50 H	∞	∞	∞	∞	4.5/3
with 190-A 40 contactor or 190-CL1 current limiter switching capacity Icn P-1/P-2 (kA)	220/380/415V	50 H	∞	∞	∞	∞	∞
	440V	50 H	∞	∞	∞	∞	∞
	500V	50 H	∞	∞	∞	∞	∞
	660/690V	50 H	∞	∞	∞	∞	10/7.5

Backup Fuses (A)

190-MN + 190-P__ backup fuse aM or gL required when available current Icc exceeds Icn	220/380/415V	50 H	NR	NR	NR	NR	NR
	440V	50 H	NR	NR	NR	NR	NR
	500V	50 H	NR	NR	NR	NR	NR
	660/690V	50 H	NR	NR	NR	NR	63
with 190-A 40 or 190-CL1 backup fuse aM or gL required when available current Icc exceeds Icn	220/380/415V	50 H	NR	NR	NR	NR	NR
	440V	50 H	NR	NR	NR	NR	NR
	500V	50 H	NR	NR	NR	NR	NR
	660/690V	50 H	NR	NR	NR	NR	80

NR = Not Required

Short-Circuit Switching Capacity, Continued

The following information is not for use in Canadian and U.S. Applications.

Cat. No. 190-MN + 190-P__ Trip Unit Manual Interrupter →	060	10	160	250	320	400
Adjustable Thermal Current (A)	4...6	6...10	10...16	16...27	24...32	32...42
Adjustable Magnetic Trip Range (A)	50...80	80...140	130...220	200...350	275...425	350...50

Switching Capacity (kA)

190-MN + 190-P__ switching capacity Icn P-1/P-2 (kA)	220/380/415V	50 Hz	∞	R/30	R/30	30/10	30/10	30/10
	440V	50 Hz	∞	10/7	10/7	10/7	10/7	10/7
	500V	50 Hz	∞	7/4.5	7/4.5	7/4.5	7/4.5	7/4.5
	660/690V	50 Hz	4.5/3	4.5/3	4.5/3	4.5/3	4.5/3	4.5/3
with 190-A 40 contactor or 190-CL1 current limiter switching capacity Icn P-1/P-2 (kA)	220/380/415V	50 Hz	∞	∞	∞	∞	∞	∞
	440V	50 Hz	∞	∞	∞	∞	∞	∞
	500V	50 Hz	∞	∞	∞	∞	∞	∞
	660/690V	50 Hz	10/7.5	10/7.5	10/7.5	10/7.5	10/7.5	10/7.5

Backup Fuses (A)

190-MN + 190-P__ backup fuse aM or gL required when available current Icc exceeds Icn	220/380/415V	50 Hz	NR	NR	NR	160	160	160
	440V	50 Hz	NR	80	100	125	160	160
	500V	50 Hz	NR	80	100	125	160	160
	660/690V	50 Hz	80	80	100	125	160	160
with 190-A 40 or 190-CL backup fuse aM or gL required when available current Icc exceeds Icn	220/380/415V	50 Hz	NR	NR	NR	NR	NR	NR
	440V	50 Hz	NR	NR	NR	NR	NR	NR
	500V	50 Hz	NR	NR	NR	NR	NR	NR
	660/690V	50 Hz	80	10	100	160	160	160

NR = Not Required

Short-Circuit Protection Requirements

North American Market Only

Cat. No.							
190-MN Manual Interrupter + 190-P__ Trip Unit			00	010	016	024	040
Adjustable Thermal Current	A	0.4...0.6	0.6...1.0	1.0...1.6	1.6...2.4	2.4...4.0	
Adjustable Magnetic Trip Range	A	5...8	8...14	14...22	20...35	35...55	
Max. 3Ø horsepower ❶	230V/60 Hz	HP	–	–	–	1/2	1
	460V/60 Hz	HP	–	1/2	3/4	1	2
	575V/60 Hz	HP	–	1/2	1	1-1/2	3

Single Motor Application

Max. backup protection for 190-M manual interrupter + 190-P__ trip unit	Max. Fuse	A	Per U.S. N.E.C. Table 430-152 (usually 175% motor full load current for time delay fuse)			
	Max. Circuit Breaker Size	A	Per U.S. N.E.C. Table 430-152 (usually 250% motor full load current for inverse time circuit breaker)			
Max. backup protection for 190-M manual interrupter + 190-P__ trip unit + 190-A40* contactor module	Max. Fuse	A	Per U.S. N.E.C. Table 430-152 (usually 175% motor full load current for time delay fuse)			
	Max. Circuit Breaker Size	A	Per U.S. N.E.C. Table 430-152 (usually 250% motor full load current for inverse time circuit breaker)			
Max. backup protection for 190-CPS40* combination starter plus 190-P__ trip unit	Max. Fuse	A	None required			
	Max. Circuit Breaker	A	None required			

Group Motor Applications

Max. backup protection for 190-MN manual interrupter + 190-P__ trip unit	Max. Fuse	A	500	500	500	500	500
	Max. Circuit Breaker Size	A	500	500	500	500	500
Max. backup protection for 190-MN manual interrupter + 190-P__ trip unit + 190-A40* contactor module	Max. Fuse	A	2000	2000	2000	2000	2000
	Max. Circuit Breaker Size	A	2000	2000	2000	2000	2000

- ❶ Horsepower ratings are shown as a reference only. Selection should be based on motor full load current:
- For motors with service factor of 1.15 or greater, use motor nameplate full load current to select the trip unit with the proper thermal current range. **EXAMPLE:** Motor FLC = 17A, SF = 1.15. Select Trip Unit 190-P250 which has a thermal current range of 16-25A.
 - For motors with service factor less than 1.15: Multiply motor nameplate full load current by 0.9 and use the resulting figure to select the trip unit with the proper thermal current range. **EXAMPLE:** Motor FLC = 17A, SF = 1.0. 17A x 0.9 = 15.3A. Select Trip Unit 190-P160 which has a thermal current range of 10-16A.

Short-Circuit Protection Requirements, Continued

North American Market Only

Cat. No.			060	100	160	250	320	400
190-MN + 190-P__ Trip Unit		Manual Interrupter →						
Adjustable Thermal Current	A		4.0...6.0	6...10	10...16	16...27	24...32	32...42
Adjustable Magnetic Trip Range	A		50...80	80...140	130...220	200...350	275...425	350...500
Max. 3∅ horsepower	230V/60 Hz	HP	1-1/2	3	5	7-1/2	10	15
	460V/60 Hz	HP	3	5	10	20	20	30
	575V/60 Hz	HP	5	7-1/2	10	25	30	30

Single Motor Application, Continued

Max. backup protection for 190-MN manual interrupter + 190-P__ trip unit	Max. Fus	A	Per U.S. N.E.C. Table 430-152 (usually 175% motor full load current for time delay fuse)					
	Max. Circuit Breaker Size	A	Per U.S. N.E.C. Table 430-152 (usually 250% motor full load current for inverse time circuit breaker)					
Max. backup protection for 190-MN manual interrupter + 190-P__ trip unit + 190-A40* contactor module	Max. Fus	A	Per U.S. N.E.C. Table 430-152 (usually 175% motor full load current for time delay fuse)					
	Max. Circuit Breaker Size	A	Per U.S. N.E.C. Table 430-152 (usually 250% motor full load current for inverse time circuit breaker)					
Max. backup protection for 190-CPS40* combination starter plus 190-P__ trip unit	Max. Fus	A	None required					
	Max. Circuit Breaker	A	None required					

Group Motor Applications, Continued

Max. backup protection for 190-MN manual interrupter + 190-P__ trip unit	Max. Fuse	A	500	500	500	500	500	500
	Max. Circuit Breaker Size	A	500	500	500	500	500	500
Max. backup protection for 190-MN manual interrupter + 190-P__ trip unit + 190-A40* contactor module	Max. Fuse	A	2000	2000	2000	2000	2000	2000
	Max. Circuit Breaker Size	A	2000	2000	2000	2000	2000	2000

Bulletin 190
IEC Modular Starter System
Specifications, Continued

Environmental			
Temperature	Storage Open Enclosed Ambient temperature compensation (overload)	-25° C...+70° C -25° C...+60° C -25° C...+40° C -5° C...+60° C	
Climatic Tests	Damp heat to IEC 68 Pt. 2-30	Dry heat to IEC 68 part 202 85°C	
Altitude	3000		
Electrical Ratings			
Main Contacts			
Rated Insulation Voltage U_i	690V		
Uninterrupted Current I_U	42A		
Frequency	50...60 H		
Heat Loss	Manual motor starter Integrated starter or coordinated protected starter	14 W 23 W	
Electrical Life	Manual interrupter Contactor module (see curve page 15)	AC3 50000 ops at 20 kW AC3 1000000 ops at 20 kW AC4 30000 ops at 15 kW	
Maximum Switching Frequency	Manual Interrupter Contactor Module (see curve page 15)	60 OPS/HR	
Motor Voltage	AC3 DC4	690V AC Max. 230V DC Max.	
Short Circuit Switching Capacity	See page 15		
Contactor Module			
Operating Range	Pick up Drop out	85%...110% nameplate voltage 60%...40% nameplate voltage	
Power Consumption	Pick up Seal	≤190 VA ≤13 VA	
Duty Factor	100%		
Operating Times	≤9...30 ms ≤4...12 ms	closing delay opening delay	
Making Capacity	400A	cos ϕ = 0.35 cos ϕ = 1	
Breaking Capacity	400A	cos ϕ = 0.35 230...690V	
AC 1 Duty	Thermal current I_{th} = operating current I_e open or enclosed	16-2/3...400 Hz	
AC 3/AC 4 Duty	Rated Operating Current Open or Enclosed		
	Voltage	AC 3 I_e (A)	AC 4 I_e (A)
	230V AC/50 Hz	40	30
	415V AC/50 Hz	40	30
	440V AC/50 Hz	40	30
	500V AC/50 Hz	32	28
	690V AC/50 Hz	25	21
Trip Unit			
Residual Error	Less than 5% at 40° C, Less than 10% at 60° C		
Short Circuit Trip Tolerance	±20%		
Trip Unit for Motor Loads	11 adjustable overload trip ranges Adjustable short circuit trip range Phase loss sensitivity to IEC 292-1	0.4...40A 8.5...14 I_U	
Trip Unit for System Protection	5 adjustable overload trip ranges Adjustable short circuit range	6...40A 5...8.5 x I_U	

Electrical Ratings, Continued

Contactormodule Life Load Curves for Squirrel-Cage Motors

Normal Switching Duty		Extreme Switching Duty	
Operating characteristics	Starting: From rest Stopping: After attaining full running speed	Operating characteristics	Inching, plugging, reversin
Electrical characteristics	Make: Up to 6x rated motor current Break: 1x rated motor current	Electrical characteristics	Make: 6x rated motor current Break: 6x rated motor current
Utilization category	99.9% AC-3 + 0.1% AC-4	Utilization category	100% AC-4

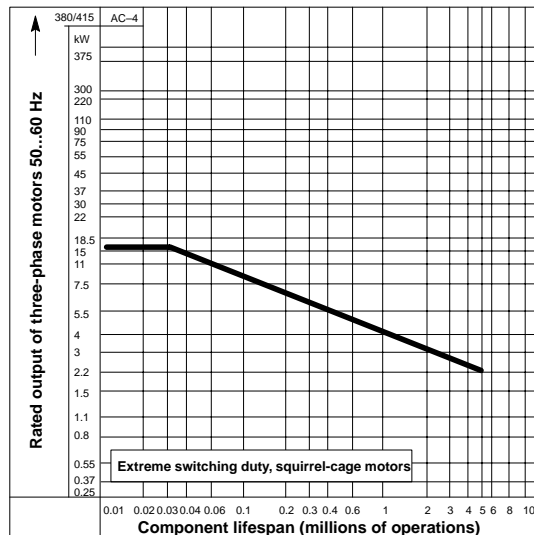
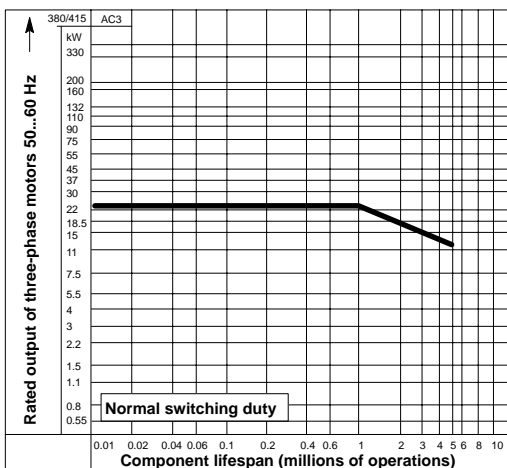

Contactormodule Switching Frequency Curve

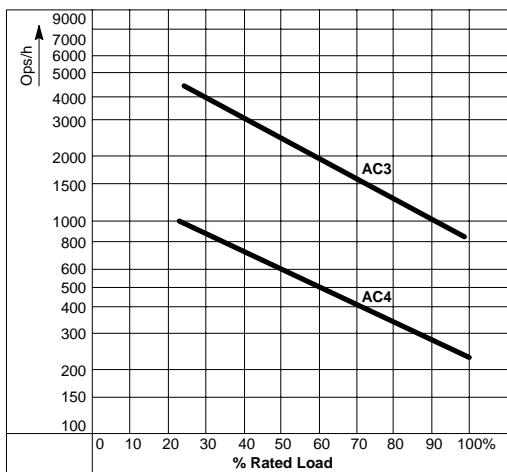

Electrical Ratings, Continued

Manual Motor Starter and Protector — Let-through curves

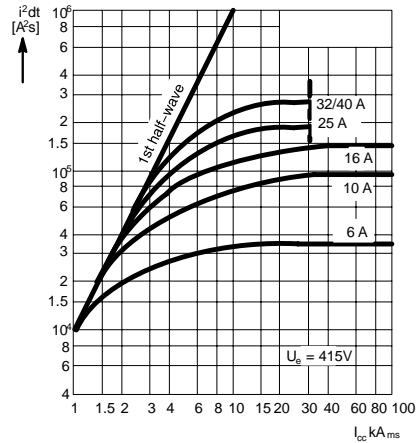
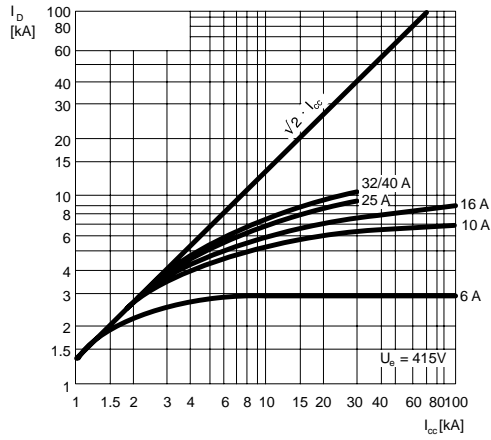

Integrated Starter — Manual Starter With Current Limiter Module — Let-through curves

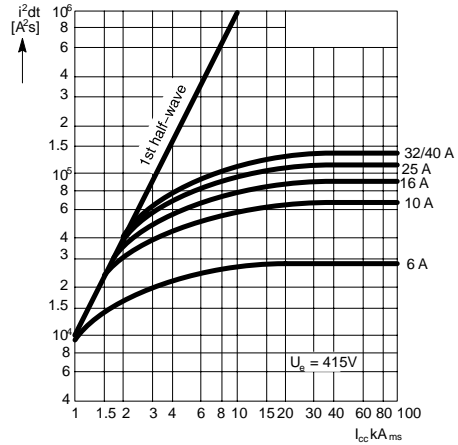
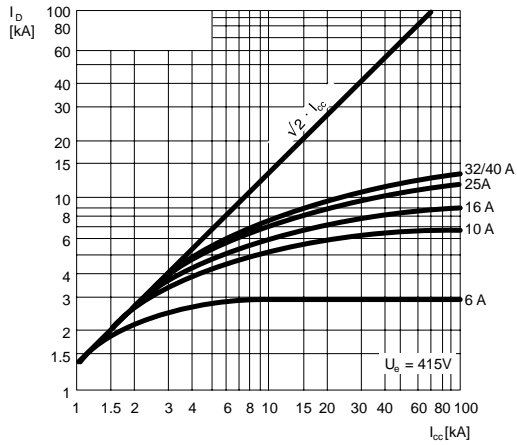

Trip Curves

Motor Protection — Cat. No. 190-P

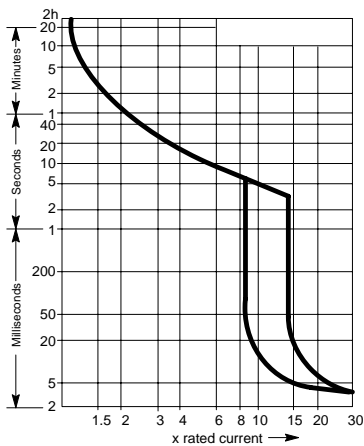

System protection — Cat. No. 190-P L

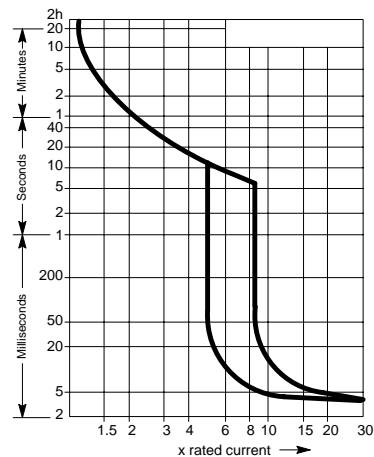

Mechanical Ratings

Impact Resistance	20 m	Manual motor starter	30 G	
		Integrated starter	8 G	
		Coordinated protected starter	8 G	
Mechanical Life	Manual interrupter Contactor module	100000 ops 5000000 ops		
Installed Position	Manual motor starter Integrated starter Coordinated protected starter	No restrictions Within 30° of vertical plane Within 30° of vertical plane		
Degree of Protection	IP20 VDE 0106 Part 100			
Terminal Capacities	Power terminals 1 conducto	Solid or stranded	1.0mm ² ...16mm ²	AWG 14...6
		Stranded with ferrule	1.5mm ² ...10mm ²	AWG 14...6
	Power terminals 2 conducto	Solid or stranded	1.0mm ² ...6mm ²	AWG 14...6
		Stranded with ferrule	1.5mm ² ...6mm ²	AWG 14...6
	Control/accessory terminals 1 or 2 conductor	Solid or stranded with ferrule	0.5mm ² ...2.5mm ²	AWG 18...14

Approximate Shipping Weights	Cat No.	kg (lb)
Manual Interrupter	190-MN	0.450 (1.00)
Trip Unit	190-P__	0.218 (0.48)
Contactor Module	190-A40__	0.850 (1.87)
Auxiliary Contacts	190-A11	0.087 (0.19)
	190-A22	0.102 (0.22)
	190-AC11/11	0.094 (0.21)
	190-A11/11	0.180 (0.40)
	190-A11C	0.180 (0.40)
Trip Indicating Contacts	190-A22C	0.180 (0.40)
	190-T11/11	0.042 (0.09)
Amplifier Modul	190-N3, N4, N5	0.085 (0.19)
Remote Operator	190-RC__	0.5 (1.10)
Undervoltage Trip	190-UV__	0.188 (0.41)
Shunt Trip	190-RT__	0.188 (0.41)
Current Limiter Module	190-CL1	0.522 (1.15)
Separate Mounting Base	190-N2	0.147 (0.32)
Adaptor Plate	190-N1	0.145 (0.32)

Bulletin 190
IEC Modular Starter System
Specifications, Continued

Auxiliary Contacts			
Rated Insulation Voltage	500V AC	600V DC	
	Separation from main contacts to VDE 0106 Part 100 up to 690V AC		
Rated Operating Current	AC II	220/240V 50 Hz	$I_e = 6A$
		380/415V 50 Hz	$I_e = 3A$
		440/500V 50 Hz	$I_e = 1.5A$
	DC II	24V	$I_e = 1A$
		60V	$I_e = 0.8A$
		110V	$I_e = 0.7A$
		220V	$I_e = 0.3A$
		L/R < 200 ms	
Electrical Life	190-A11	A22 50000 ops	
	190-T11/11	5000 op	
	190-A22C, A11C, A11/11, AC11/11	1000000 ops	
Mechanical Life	190-A11, A22	100000 ops	
	190-T11/11	10000 ops	
	190-A11C, A22C, A11/11, AC11/11	5000000 ops	
Remote Operator			
Rated Insulation Voltage	500V AC		600V DC
Operating Range	AC or DC		85%...110% of nameplate voltage
Power Consumption	AC	700 VA for 15 ms	
	DC	700 W for 15 ms	
	L/R	≤ 200 ms	
Make Time	≤ 50 m		
Break Time	≤ 50 m		
Reset Time To Off	≤ 20 m		
Switching Frequency	60 ops/hr		
Mechanical Life	50000 ops		
Undervoltage Trip			
Rated Insulation Voltage	690V AC		
Drop Out	70%...35% of nameplate voltag		
Power Consumption	Pick up	5 VA AC	3 W DC
	Seal	3 VA AC	3 W DC
Drop Out Delay	200 m		
Shunt Trip			
Operating Range	AC or DC	70%...110% of nameplate voltage	
Power Consumption	Pick up	5 VA AC	3 W DC
	Seal	3 VA AC	3 W DC
Amplifier Module			
Rated Insulation Voltage	415V AC		
Mechanical Life	10000000 ops		
Operating Range	85%...110% of nameplate voltage		
Duty Factor	100%		
Uninterrupted Current	6A		
Input	24V 15 mA DC	48V 10 mA DC	125V 10 mA DC
Output	Max. 415V AC	AC11	AC11 2A
	Max. 240V DC	DC11	DC11 0.11A

Manual Motor Starter/Protector

Dimensions are shown in millimeters (inches). Dimensions are not intended for manufacturing purposes.

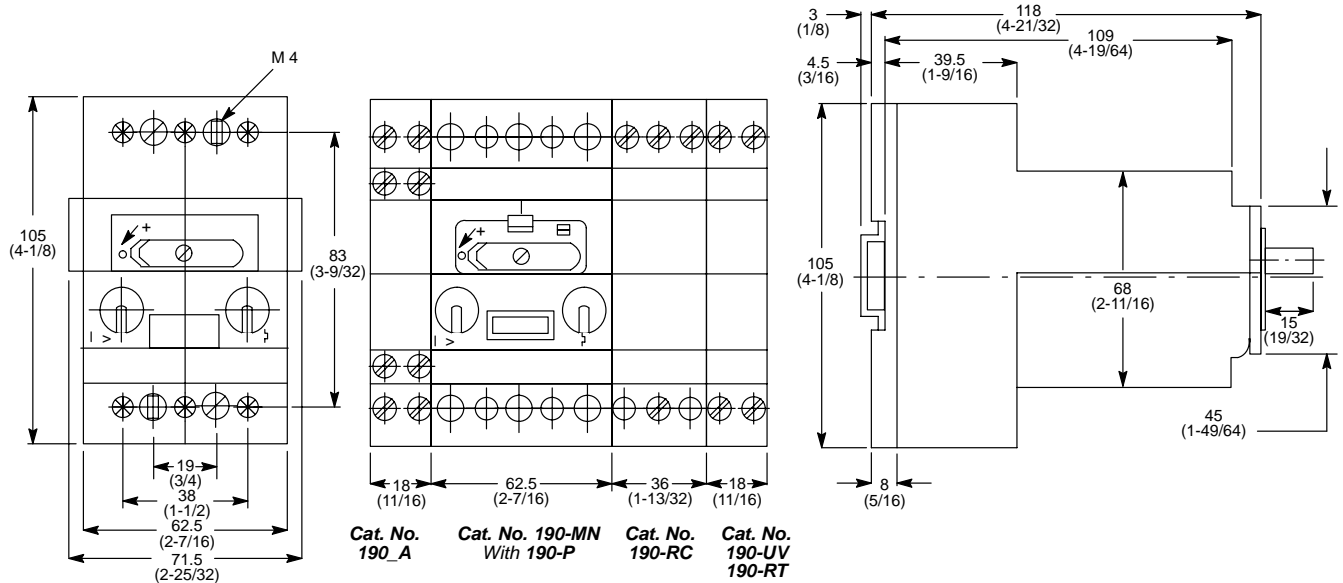

Auxiliary Contacts

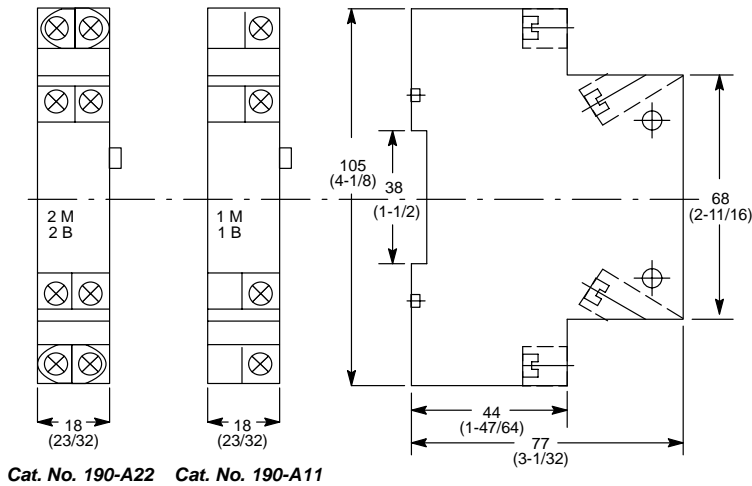

Trip Indicating Contacts

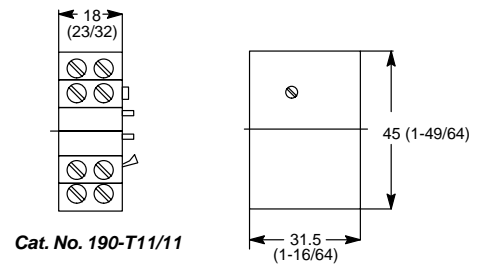

Bulletin 190
IEC Modular Starter System
 Approximate Dimensions, Continued

Integrated Starter Coordinated Protected Starter

Dimensions are shown in millimeters (inches). Dimensions are not intended for manufacturing purposes.

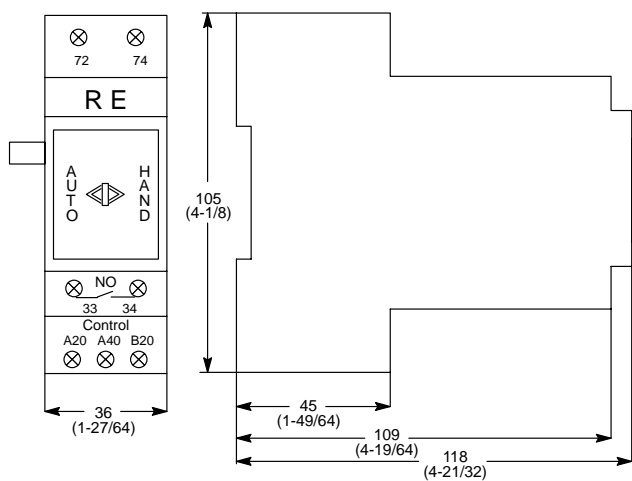
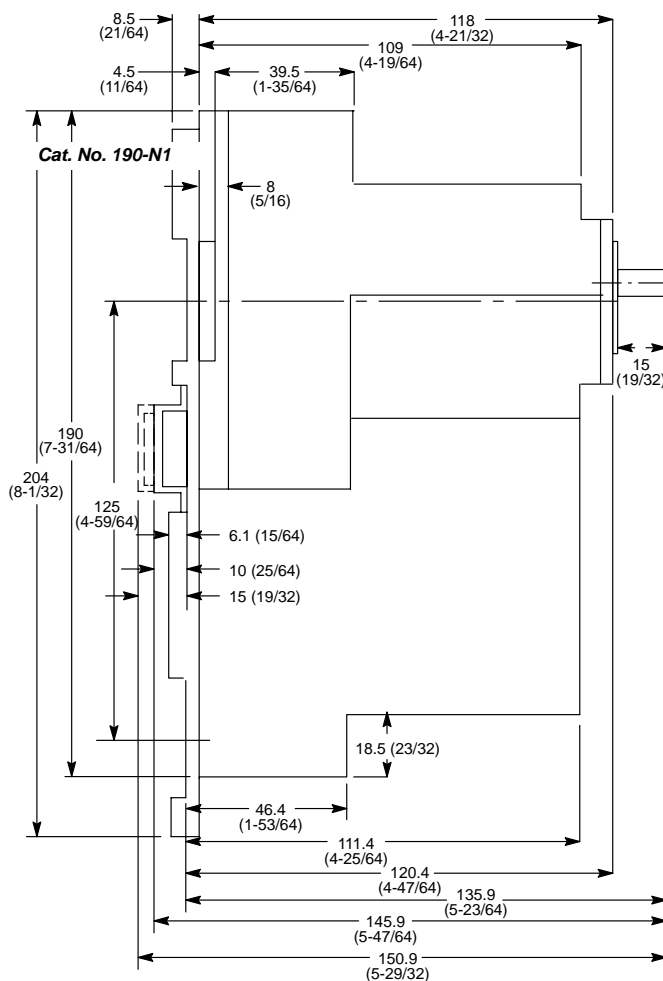
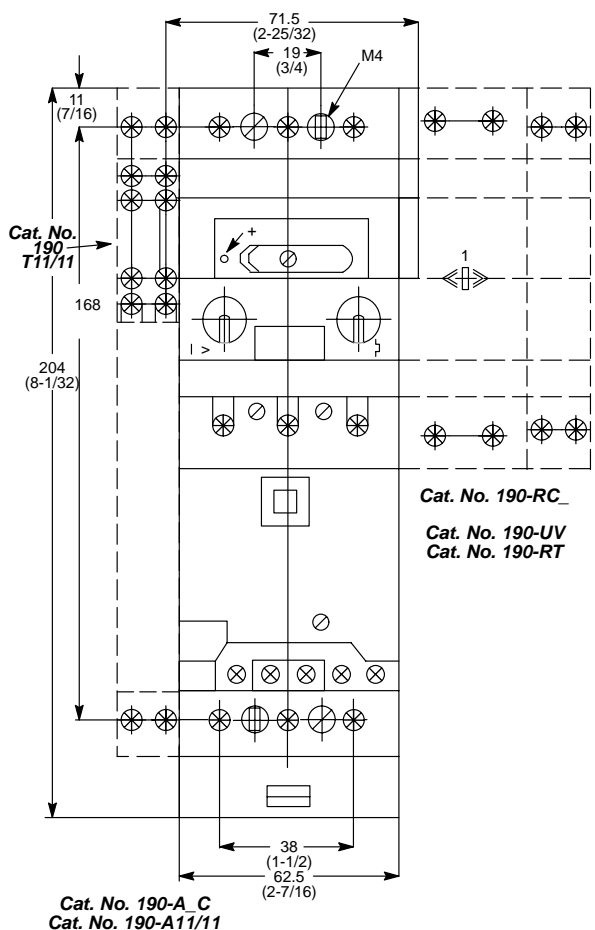

Remote Operator
Cat. No. 190-RCS, RCE

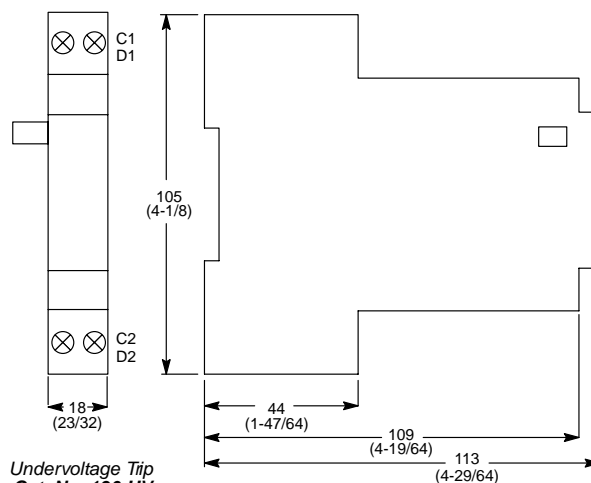

Undervoltage Trip
Cat. No. 190-UV

Shunt Trip
Cat. No. 190-RT

Contactor Module

Dimensions are shown in millimeters (inches). Dimensions are not intended for manufacturing purposes.

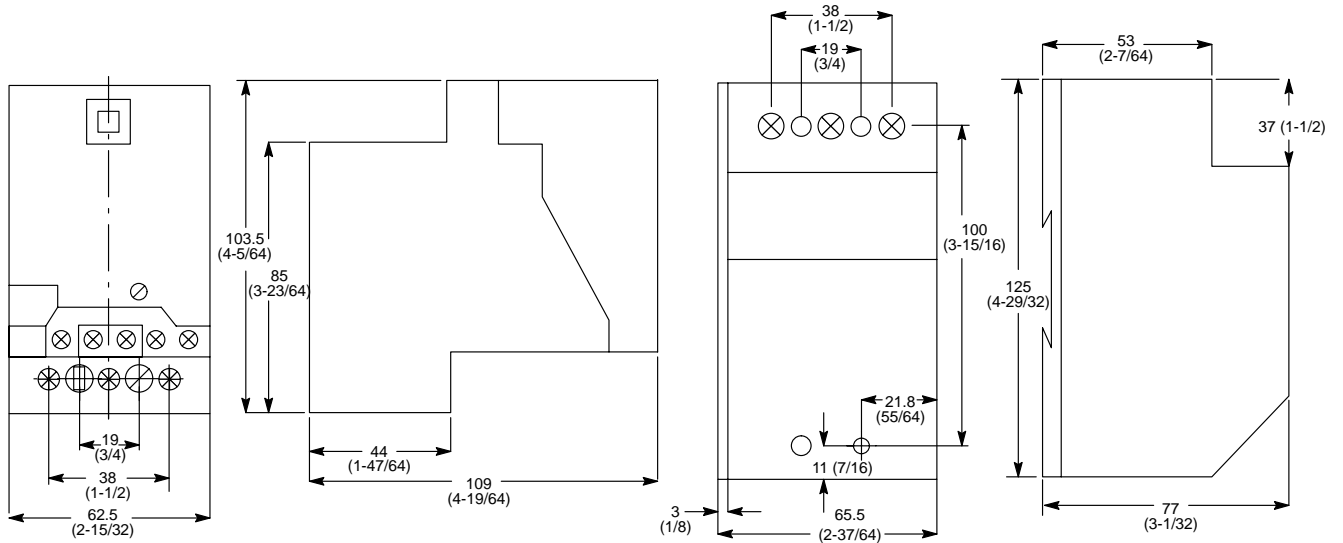

Contactor Module
 Cat. No. 190-A40
 Current Limiter Module
 Cat. No. 190-CL1

Separate Mounting Base
 Cat. No. 190-N2

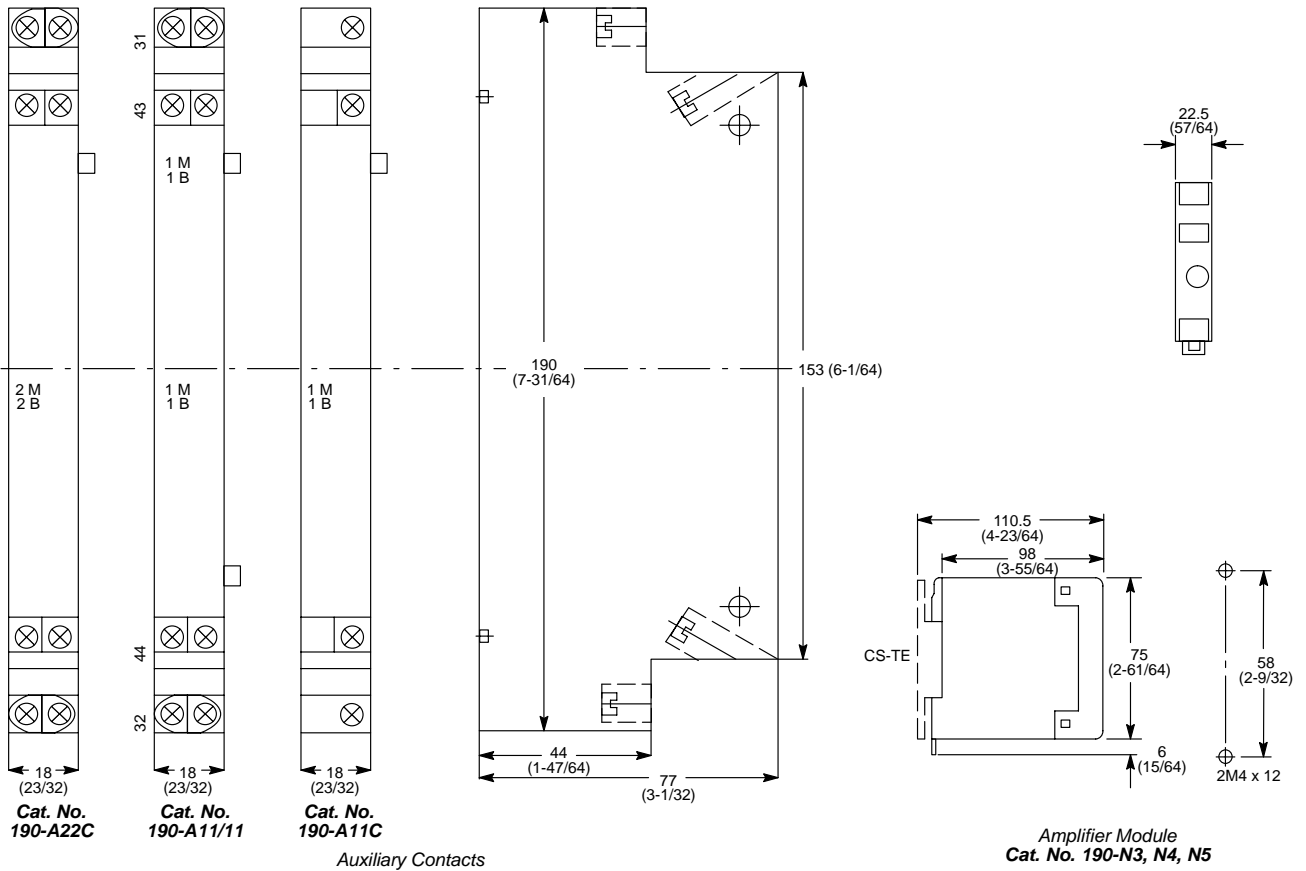

Cat. No. 190-A22C

Cat. No. 190-A11/11

Cat. No. 190-A11C

Auxiliary Contacts

Amplifier Module
 Cat. No. 190-N3, N4, N5

Reach us now at www.rockwellautomation.com

Wherever you need us, Rockwell Automation brings together leading brands in industrial automation including Allen-Bradley controls, Reliance Electric power transmission products, Dodge mechanical power transmission components, and Rockwell Software. Rockwell Automation's unique, flexible approach to helping customers achieve a competitive advantage is supported by thousands of authorized partners, distributors and system integrators around the world.

Americas Headquarters, 1201 South Second Street, Milwaukee, WI 53204, USA, Tel: (1) 414 382-2000, Fax: (1) 414 382-4444
European Headquarters SA/NV, avenue Herrmann Debroux, 46, 1160 Brussels, Belgium, Tel: (32) 2 663 06 00, Fax: (32) 2 663 06 40
Asia Pacific Headquarters, 27/F Citicorp Centre, 18 Whitfield Road, Causeway Bay, Hong Kong, Tel: (852) 2887 4788, Fax: (852) 2508 1846



**Rockwell
Automation**