

Presence Sensing Safety Devices

Safety Edges

Overview

System Components

The Safedge sensitive edge systems are used in a variety of applications where the edge of an object must be detected by contact. The Safedge system consists of three parts: 1) a c-rail, which is used to mount the profile; 2) a profile, which contains the sensing surface; and 3) a control unit, which checks the operation of the profile and interfaces with the control system. A typical system is shown below.

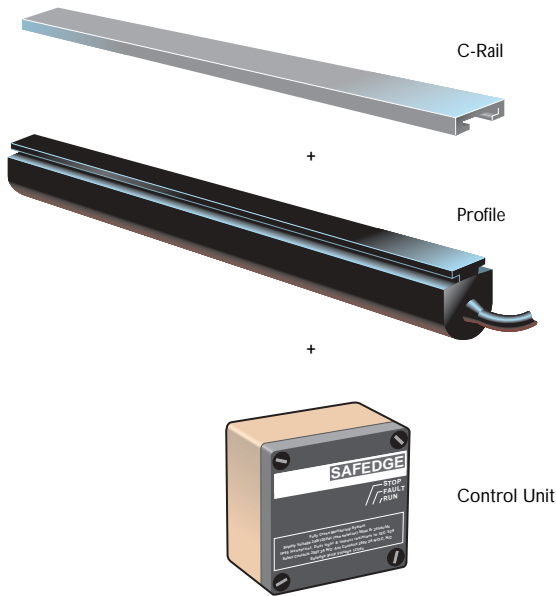

Sensing Surface

The profile is best actuated along its sensing surface. The sensing surface of the Safedge system is active along almost the full length of the edge. The 10 millimetres at the beginning and end are not active.

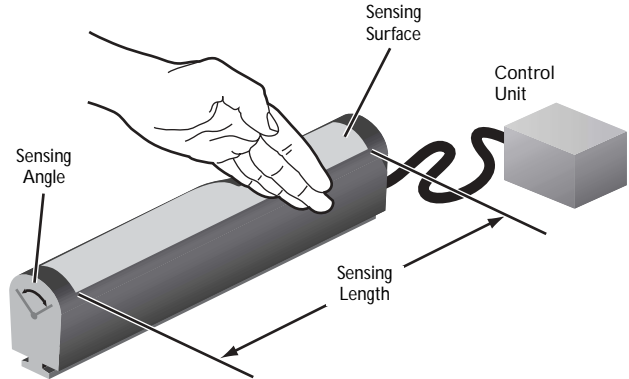

One distinct advantage of the Safedge system is the active corners. Pressure applied to the corners is detected by the control unit.

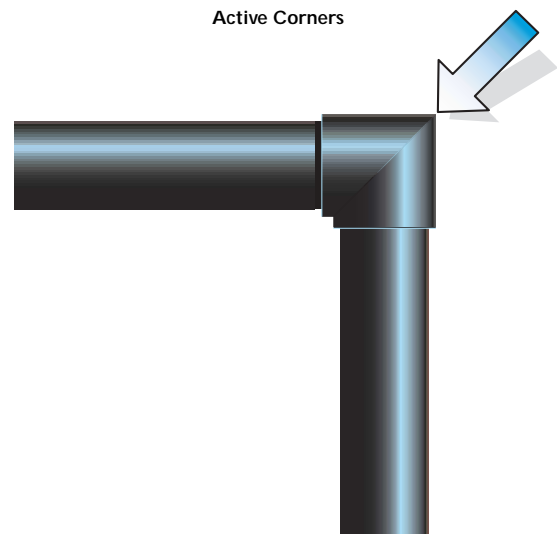

Operating Principle

The profile works on the principle of a two-wire design with conductive rubber. Two wires run the length of the profile. The wires are terminated with a known resistor. When the profile is deformed, the conductive rubber comes in contact with each other and causes the overall resistance to drop.

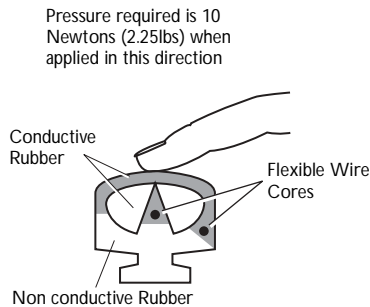

Pressure required is 10 Newtons (2.25lbs) when applied in this direction

The control unit provides a voltage source to the wires in the profile. It continuously checks the continuity of the wires for shorts, opens and changes in resistance. If the circuit opens, becomes shorted, or the resistance changes, the output of the control unit turns off.

The control unit can also be used to monitor the performance of the output switching devices.

Force Travel Relationship

Since the Safedge system is a contact device, a force is required to operate the device. This force is dependent on the shape of the object applying the force, the speed of the object and deformation distance on the profile. To help understand the force requirements, the European standard EN1760-1 provides three test objects travelling at two speeds. Shown in the graph below is the force that is applied over the deformation distance on the surface of the profile. Note that the force required to operate the corners is greater than the force required along the straight section of the profile. This force must be used as a guideline, as the inanimate object can not be harmed.

Allen-Bradley HMIs

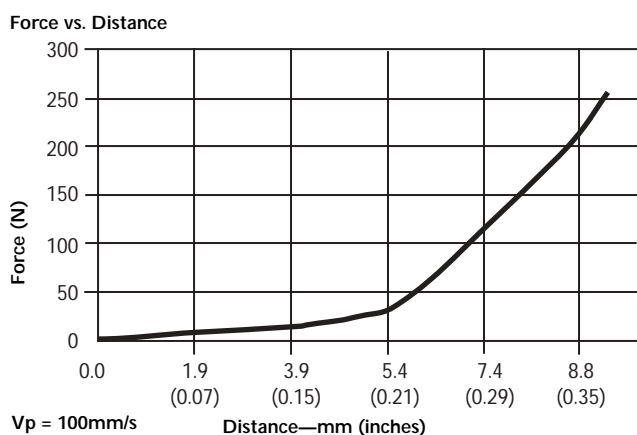
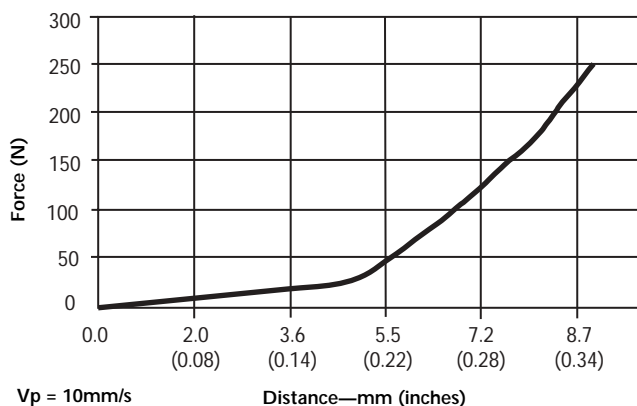

Risk Assessment

A risk assessment must be performed to determine the proper use of the edge system. Additional protective measures must be used when an individual can reach around or over the edge system and gain access to a hazard. The edge system is designed to be a contact type of system. Therefore “cushion factor” is an important consideration.

Selecting the Cushion Factor

One of the important characteristics of edge systems is called cushion factor. The cushion factor is the distance the profile can be depressed after the signal is generated. This is important when the profile is mounted on automated doors.

Automated doors will continue to close for some finite time after the profile sends the initial stop signal. This is known as the system response time. The system response time is the sum of the Safedge control unit response time, the control system response time, and the mechanical stopping time. Systems with longer response time should utilize larger cushion factors. Users must validate that injury does not occur if parts of the body get jammed, for example between the sensing edge and the fixed part of a machine.

Users might also consider a reversing option. When the profile is depressed, the Safedge control unit sends a signal to a reversing relay. Since the reversing relay is not a safety rated device, the user must still confirm that injury does not occur if parts of the body get jammed.

Presence Sensing Safety Devices

Safety Edges

Overview

Typical Applications

Typical applications for sensitive edge systems are:

- Sliding doors
- Sliding gates
- Automated guided vehicles
- X-Y tables
- Fence tops
- Scissor jacks
- Loading platforms

The profile is mounted on the leading edge of the moving object. As the profile comes in contact with an object, the sensing surface of the profile deforms. The deformation causes the conductive rubber parts to make contact and reduce the circuit resistance. The control makes contact.

Typically, the edge of the object is leading edge and is moving, like a sliding door or gate. Edge systems have also been used on the leading edges of X-Y tables and automated guided vehicles.

In some applications, a drip edge or seal is needed to reduce wind and rain leaking into a door. The Safedge system accommodates both types of applications. Safedge has three profiles that include a sealing lip.



Safedge can also be ordered with a rubber cover as shown below. This allows compression of the rubber boot without deforming the profile.

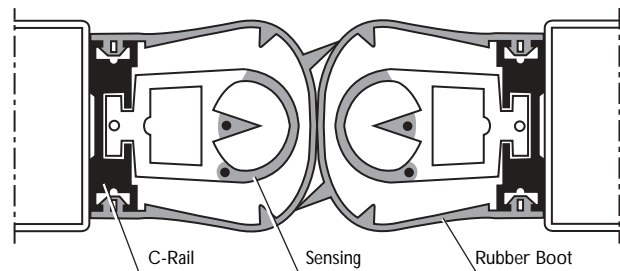

Allen-Bradley HMIs

Cable Termination

The cable can be terminated in one of four ways providing flexibility in design and installation of cable routing. Specify the LHT or RHT from the point of view of looking directly at the end of the profiles as shown below.

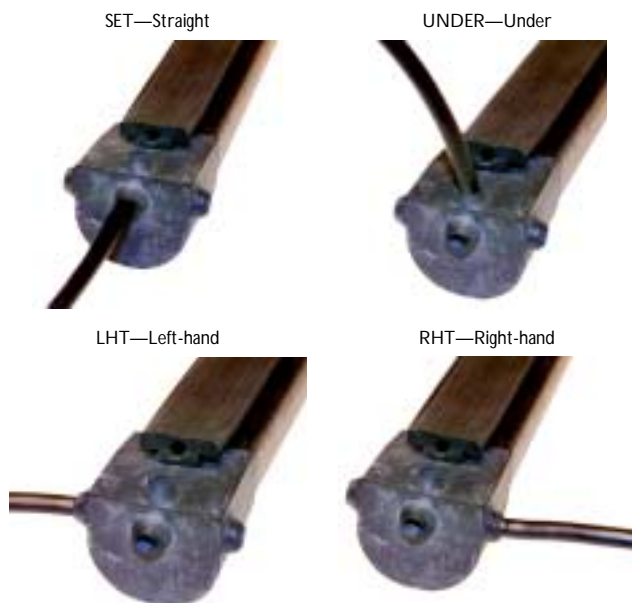

Connection Methods

The profiles can be connected in one of two ways: series or parallel. Either method provides the same performance. Selection of the method is determined by ease of installation. The more popular method is series.

Series Connection

Connection in series
 If more than one profile is to be used, they are normally connected in series as shown.

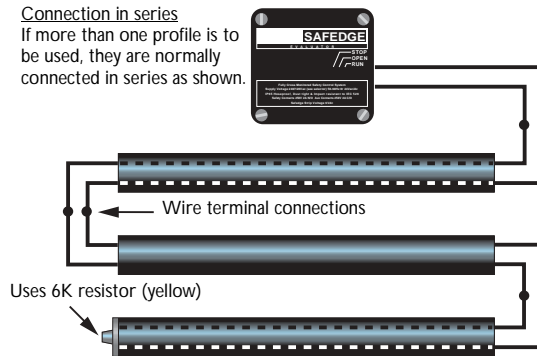

Parallel Connection



A maximum of two profiles can be connected in parallel.

Safety Edges Safedge™ Profiles

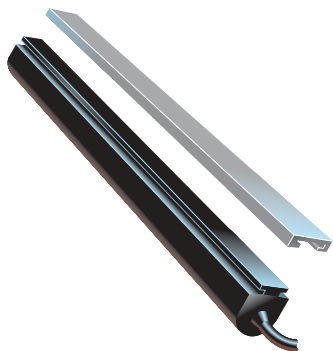

Description

The ability of the Safedge profile to out perform competition lies in its innovative design. It uses a combination of non conductive rubber and flexible wire cored conductive rubber bonded together so it keeps bouncing back into shape even after repeated compressions.

The Safedge profiles come in 3 different cushions factors: 5mm (0.2in), 19mm (0.75in) and 41mm (1.6in). Cushion factor is the distance the profile can be depressed after a signal has been generated. The profiles are also offered with a sealing lip which is designed to reduce drafts between the profile and opposing surface.

The profiles come in two different materials. Use the EPDM material in the presence of conductive fluids. The NBR/CR material performs better in the presence of oils. Review the chemical resistance chart to help make the best choice of material. If in doubt, a small sample of the profile should be tested for chemical resistance before a final selection is made.

The Safedge profile has no rigid internal parts which can “break through” or cause fatigue failures after prolonged use. The multi-stranded copper wire core throughout the length of the strip insures that there are no problems of resistance build up on long lengths.

Features

- Various profiles
- Conductive rubber technology
- Up to 50m lengths
- Aluminium, plastic or zinc coated steel, mounting rails
- Rubber boot optional
- Active corners
- Sealing lip available

Specifications

Standards	EN1760-2, EN 954-1, ISO13849-1, IEC/EN60204-1, ANSI B11.19, AS 4024.5
Approvals	CE marked for all applicable directives, cULus and TÜV, c-tick not required
Power supply	Operates on 4V DC supplied from control unit
Operating temperature	EPDM material -5°C to +55°C (23°F to 131°F) NBR/CR material 0°C to + 55°C (32°F to 131°F)
Humidity	90% RH
Enclosure Protection	IP67 (NEMA 6P)
Conductor Size	(18AWG)
Materials	EPDM Ethylene Propylene Diene Modified Rubber NBR/CR Acrylonitrile (34% nitrile) Butadiene Rubber/Chloroprene Rubber
Mounting	Any position using Type C112 “C” rail
Weight	See Ordering Details

Chemical Resistance of Safedge Profile

Substance	Resistance—“S” Profile EPDM	Resistance—“N” Profile NBR/CR
Acetic Acid (10%)	Good	Good
Acetone	Good	Fair
Ammonium Hydroxide (35%)	Good	Good
Benzene	Poor	Poor
Diesel Oil	Poor	Good
Ethyl Alcohol (Ethanol)	Good	Good
Hydrochloric Acid (10%)	Good	Good
Lubricating Oil	Poor	Good
Nitric Acid (10%)	Good	Fair
Petrol	Poor	Fair
Silicone Fluids	Good	Good
Sodium Chloride (25%)	Good	Good
Trichlorethylene	Good	Poor
Vegetable Oils (general)	Good	Good
Water (distilled)	Good	Good
Water (sea)	Good	Good

Product Selection—Profiles







Code (Page 2-100)	Dimension	Profile	Description	Cushion Factor	Length— m (ft)	Catalogue Number
A		0110S	Black, EPDM, Weight: 463g/m (0.33lbs/ft)	5mm	5 (16.4)	440F-E0110S05
					10 (32.8)	440F-E0110S10
					20 (65.6)	440F-E0110S20
C		0110N	Black, NBR/CR, Weight: 460g/m (0.31lbs/ft)	5mm	5 (16.4)	440F-E0110N05
					10 (32.8)	440F-E0110N10
					20 (65.6)	440F-E0110N20
B		0110R	Red, EPDM, Weight: 502g/m (0.34lbs/ft)	5mm	5 (16.4)	440F-E0110R05
					10 (32.8)	440F-E0110R10
					20 (65.6)	440F-E0110R20
E		1610S	Black, EPDM, Weight: 843g/m (0.57lbs/ft)	19mm	5 (16.4)	440F-E1610S05
					10 (32.8)	440F-E1610S10
					20 (65.6)	440F-E1610S20
F		1610N	Black, NBR/CR, Weight: 837g/m (0.56lbs/ft)	19mm	5 (16.4)	440F-E1610N05
					10 (32.8)	440F-E1610N10
					20 (65.6)	440F-E1610N20
H		0310S	Black, EPDM, Weight: 1209g/m (0.81lbs/ft)	41mm	5 (16.4)	440F-E0310S05
					10 (32.8)	440F-E0310S10
					20 (65.6)	440F-E0310S20
D, J		0510S	Black, EPDM, with Sealing Lip Weight: 545g/m (0.37lbs/ft)	5mm	5 (16.4)	440F-E0510S05
					10 (32.8)	440F-E0510S10
					20 (65.6)	440F-E0510S20
G, K		0804S	Black, EPDM, with Sealing Lip Weight: 1013g/m (0.68lbs/ft)	19mm	5 (16.4)	440F-E0804S05
					10 (32.8)	440F-E0804S10
					20 (65.6)	440F-E0804S20

Safety Edges
Safedge™ Profiles

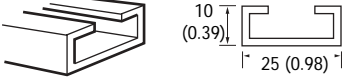

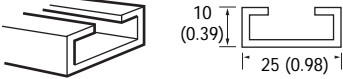

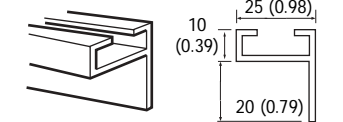
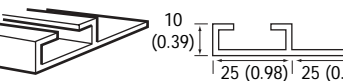
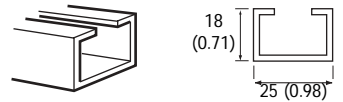
Product Selection—Profiles

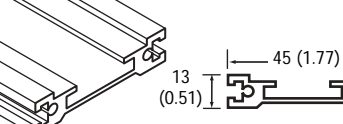
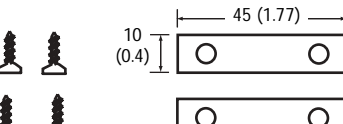
Code (Page 2-100)	Dimension	Profile	Description	Cushion Factor	Length— m (ft)	Catalogue Number
I, L		0210S	Black, EPDM, with Sealing Lip Weight: 1291g/m (0.87lbs/ft)	41mm (1.61in)	5 (16.4)	440F-E0210S05
					10 (32.8)	440F-E0210S10
					20 (65.6)	440F-E0210S20
M		0118S	Black, EPDM Weight: 242g/m (0.163lbs/ft)	3.75mm (0.15in)	5 (16.4)	440F-E0118S05
					10 (32.8)	440F-E0118S10
					20 (65.6)	440F-E0118S20
N, O		1111S	Black, EPDM Weight: 680g/m (0.457lbs/ft)	NA	5 (16.4)	440F-E1111S05
					10 (32.8)	440F-E1111S10
					20 (65.6)	440F-E1111S20

Product Selection—“C” Rails

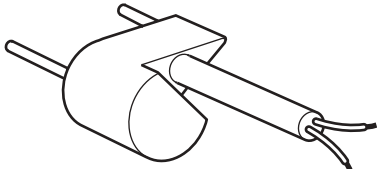
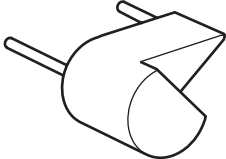
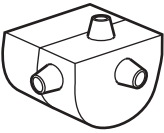
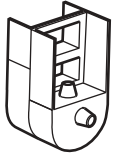
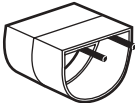
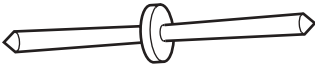

Code	Dimension—mm (inches)	Description	Catalogue Number
A		Aluminium type; Type C112/A Suitable for all profiles. 3m (9.8ft) length Weight: 258g/m (0.17lbs/ft)	440F-R1212
B		Zinc-Coated Steel; Type C112/S Suitable for all profiles 2m (6.5ft) length Weight: 663g/m (0.45lbs/ft)	440F-R1112
C		PVC Black; Type C112/PB Suitable for all profiles 3m (9.8ft) length Weight: 111g/m (0.07lbs/ft)	440F-R1212PB
D		PVC Red; Type C112/PR Suitable for all profiles 3m (9.8ft) length Weight: 111g/m (0.07lbs/ft)	440F-R1212PR
E		PVC Yellow; Type C112/PY Suitable for all profiles 3m (9.8ft) length Weight: 111g/m (0.07lbs/ft)	440F-R1212PY
F		Aluminium Vertical Lip; Type C112/A2 Suitable for all profiles 2m (6.5ft) length Weight: 368g/m (0.25lbs/ft)	440F-R1214
G		Aluminium Horizontal Lip; Type C112/A3 Suitable for all profiles 2m (6.5ft) length Weight: 388g/m (0.26lbs/ft)	440F-R1215
H		Aluminium Deep Channel; Type C112/A4 Suitable for all profiles 2m (6.5ft) length Weight: 345g/m (0.23lbs/ft)	440F-R1216
I		Aluminium; Suitable for Mini Profile Only 2m (6.5ft) length Weight: 150g/m (___lbs/ft)	440F-R1219
J		Aluminium Suitable for Rubber Boot Only ?m (ft) length Weight: 667g/m (0.448lbs/ft)	440F-R2151
NA		Aluminium End Plate for C-Rail Option J 2 Plates 4 Screws, flat head, Phillips, 10mm, #6, Weight: 7g (0.01lbs)	440F-R2152

Product Selection—Component Parts

Dimension	Name	Description	Catalogue Number
	Connector and Cable	1m	440F-A1301
		2m	440F-A1302
		5m	440F-A1305
		12m	440F-A1306
		15m	440F-A1307
	Terminator	6kΩ (yellow) resistor for series termination	440F-A1308
		15kΩ (blue) for parallel termination	440F-A1309
	Closing Cap	Closing Cap material: EPDM	440F-A1302S
		Closing Cap material: NRB	440F-A1302N
	Closing Cap	To close profiles 440F-E0310S and 440F-E1610S.	440F-A1303S
		To close profiles 440F-E1610N.	440F-A1303N
	Axial Connector	With this connector you can directly connect two profiles. Suitable for 440F-E0110S and 440F-E0110R profiles.	440F-A0061S
	Straight Pin Connector	Kit contains one pair of pins suitable for one joint.	440F-A0004
	90° Corner Connector	When using profile 440F-E0110S select	440F-A0071S
		When using profile 440F-E0110R select	440F-A0071S
		When using profile 440F-E0110N select	440F-A0071N
		When using profile 440F-E0310S select	440F-A0073S
		When using profile 440F-E1610S select	440F-A0074S
		When using profile 440F-E1610N select	440F-A0074N
	90° Corner Connector (vertical)	When using profile 440F-E0110N select	440F-A0072N
		When using profile 440F-E0110S or 440F-E0110R select	440F-A0072S
		When using profile 440F-E1610N select	440F-A0075N
		When using profile 440F-E1610S select	440F-A0075S
		When using profile 440F-E0310S select	440F-A0076S
	45° Corner Connector	When using profile 440F-E0110N	440F-A0071N45
	60° Corner Connector	When using profile 440F-E0110N	440F-A0071N60

Allen-Bradley HMIs

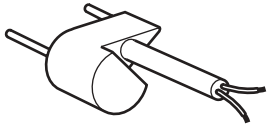
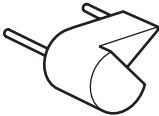
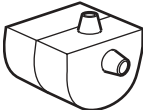
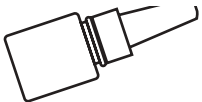
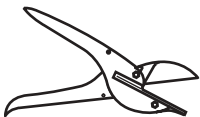
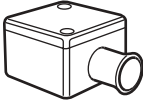
Product Selection—Component Parts

Dimension	Name	Description	Catalogue Number
	Connector and Cable	Use only on Mini Profile—1m	440F-A1181
		Use only on Mini Profile—3m	440F-A1183
		Use only on Mini Profile—5m	440F-A1185
	Terminator	Use only on Mini Profile— 8kΩ (yellow) resistor for series termination	440F-A1186
	Closing Cap	Use only on Mini Profile— Closing Cap material: EPDM	440F-A1318
	Cyanocrylate Adhesive	Contents: 3g. Sufficient for approximately 10 terminations.	440F-A0020
	Shears	Use to cut profiles.	440F-A3084
	Connection Box	Polycarbonate housing 53mm X 53mm X 35mm complete with two pole terminal and trumpet type screw on connector with strain and relief clamp. For use with coiled cable	440F-A0116
	Coiled Connection Cable	2.5m (8.2ft) (extended) of flexible coiled cable.	440F-A2450
		3.5m (11.5ft) (extended) of flexible coiled cable.	440F-A2700

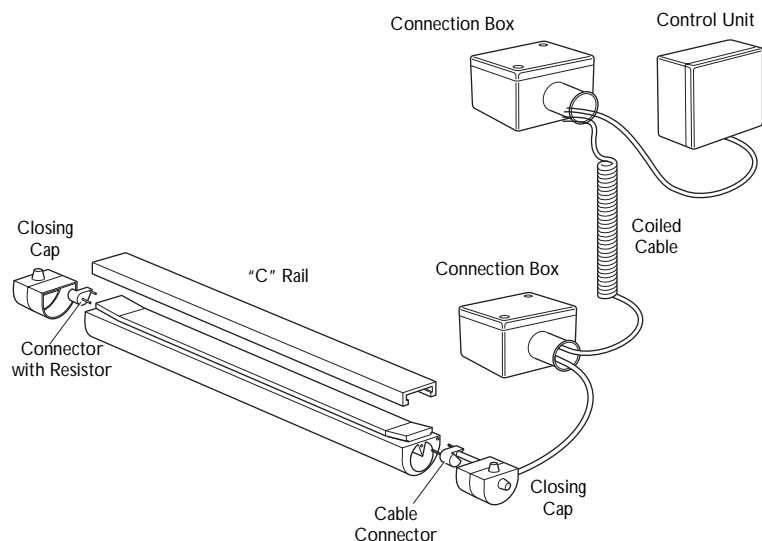

Example application of profile using coiled cable. The coiled cable can not be directly connected to the profile due to the weight of the cable. The proper use of the coiled cable is to connect the coiled cable to the profile through the connection box. The coiled cable should be secured to both the moving and stationary objects so as to prevent straining of the terminal connections.

Safety Edges

Safedge™ Profiles

Factory Assembled Product Selection (standard profile)

440F-E **C** **A** **M** **V** **01270**
a *b* *c* *d* *e*

a

Profile	
Code	Description
A	0110S
B	0110R
C	0110N
D	0510S with Sealing Lip on Right Side
E	1610S
F	1610N
G	0804S with Sealing Lip on Right Side
H	0310S
I	0210S with Sealing Lip on Right Side
J	0510S with Sealing Lip on Left Side
K	0804S with Sealing Lip on Left Side
L	0210S with Sealing Lip on Left Side
N	Rubber Boot over 0110S
O	Rubber Boot over 1610S

b

"C" Rail

Code	Description
A	1212 aluminium for "Profile" codes A-L
B	1112 zinc coated steel for "Profile" codes A-L
C	1212PB PVC black for "Profile" codes A-L
D	1212PR PVC red for "Profile" codes A-L
E	1212PY PVC yellow for "Profile" codes A-L
F	1214 aluminium with vertical lip for "Profile" codes A-L
G	1215 aluminium with horizontal lip for "Profile" codes A-L
H	1216 aluminium deep rail for "Profile" codes A-L
J	2151 aluminium for "Profile" codes N and O
N	No C-Rail (not needed)

c

Cable Entrance

Code	Description
A	LHT left entrance with 1m cable
B	LHT left entrance with 2m cable
C	LHT left entrance with 3m cable
D	LHT left entrance with 5m cable
E	LHT left entrance with 10m cable
F	RHT right entrance with 1m cable
G	RHT right entrance with 2m cable
H	RHT right entrance with 3m cable
I	RHT right entrance with 5m cable
J	RHT right entrance with 10m cable
K	SET straight entrance with 1m cable
L	SET straight entrance with 2m cable

d (continued)

Cable Entrance

Code	Description
J	RHT right entrance with 10m cable
K	SET straight entrance with 1m cable
L	SET straight entrance with 2m cable
M	SET straight entrance with 3m cable
N	SET straight entrance with 5m cable
O	SET straight entrance with 10m cable
P	UNDER entrance with 1m cable
Q	UNDER entrance with 2m cable
R	UNDER entrance with 3m cable
S	UNDER entrance with 5m cable
T	UNDER entrance with 10m cable

e

Termination

Code	Description
A	LHT left exit with 1m cable
B	LHT left exit with 2m cable
C	LHT left exit with 3m cable
D	LHT left exit with 5m cable
E	LHT left exit with 10m cable
F	RHT right exit with 1m cable
G	RHT right exit with 2m cable
H	RHT right exit with 3m cable
I	RHT right exit with 5m cable
J	RHT right exit with 10m cable
K	SET straight exit with 1m cable
L	SET straight exit with 2m cable
M	SET straight exit with 3m cable
N	SET straight exit with 5m cable
O	SET straight exit with 10m cable
P	UNDER exit with 1m cable
Q	UNDER exit with 2m cable
R	UNDER exit with 3m cable
S	UNDER exit with 5m cable
T	UNDER exit with 10m cable
U	Parallel Termination—15kΩ
V	Series Termination—6kΩ

f

Length of Edge

Code	Description
5 digit number	Enter length of edge in mm for example: 50m=50000; 500mm=00500 300mm minimum

❶ Order controller separately. See page 2-104 for selection details.

Factory Assembled Product Selection
(mini-profile)



440F-E ① M I M V 01270
a *b* *c* *d* *e*

a

Profile

Code	Description
M	0118S 3.75mm (0.15in) Cushion Factor Black, Mini Profile

b

"C" Rail

Code	Description
I	1219 aluminium for "Profile" code M
N	No C-Rail (not needed)

c

Cable Entrance

Code	Description
K	SET straight entrance 1m cable
M	SET straight entrance 3m cable
N	SET straight entrance 5m cable
P	UNDER entrance 1m cable
R	UNDER entrance 3m cable
S	UNDER entrance 5m cable

d

Termination

Code	Description
K	SET straight entrance 1m cable
M	SET straight entrance 3m cable
N	SET straight entrance 5m cable
P	UNDER entrance 1m cable
R	UNDER entrance 3m cable
S	UNDER entrance 5m cable
V	Series Termination—8kΩ

e

Length

Code	Description
5 digit number	Enter length of edge in mm for example: 50m=50000; 500mm=00500 300mm minimum

① Order controller separately. See page 2-104 for selection details.

Factory Assembled Examples

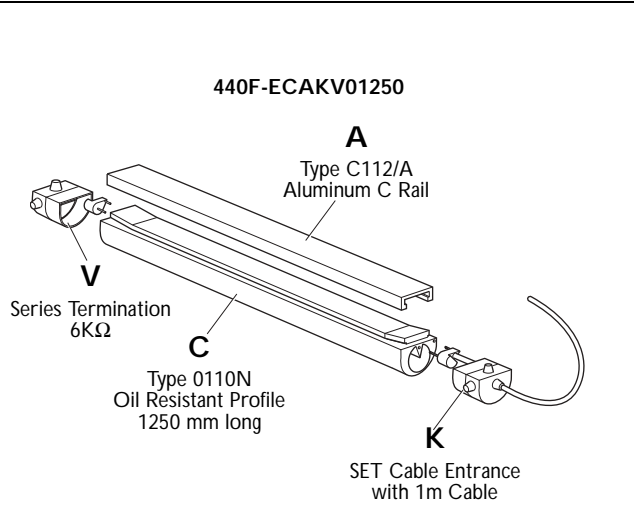

This is a single oil resistant profile which is 1250mm long. The edge is terminated with a Series Termination. A 1m cable enters straight into the closing cap from a DIN-rail mounted controller. The profile is mounted on a standard aluminium C rail.

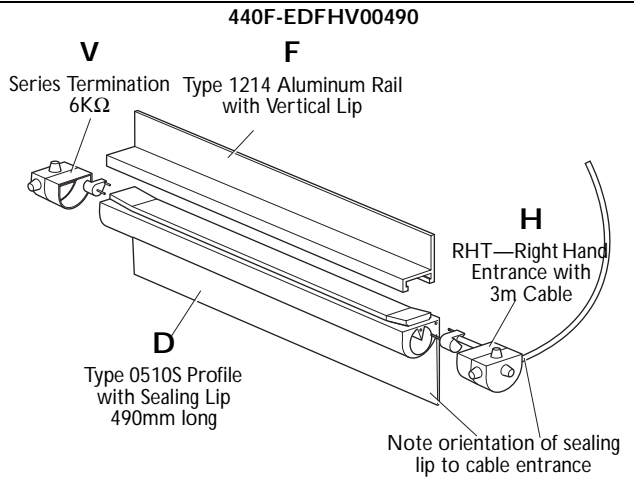

This is single profile has a sealing lip and is 490mm long. The profile is terminated with a Series Termination. A 3m cable enters into the right hand side of the closing cap from a plastic surface mounted controller. The profile is mounted on an aluminium rail with a vertical lip for ease of mounting. The orientation of the sealing lip to the vertical lip can be reversed by the user by sliding the profile out of the C Rail, rotating the C Rail 180° and then re-inserting the profile back into the C Rail.

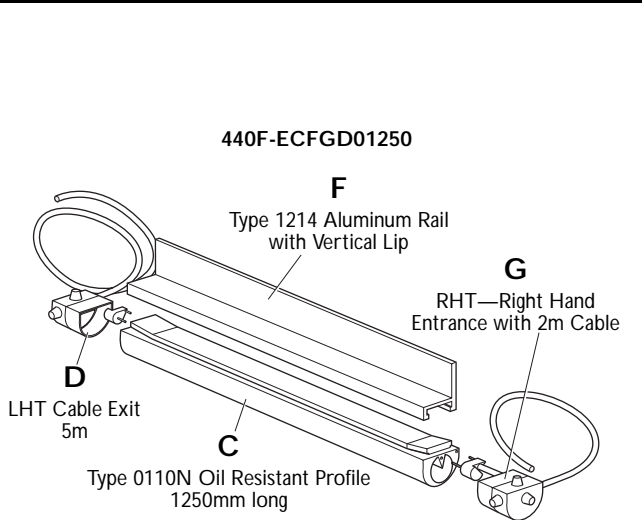

This is a single oil resistant profile which is 1250mm long. The edge is terminated with a 1m cable. A 1m cable enters straight into the closing cap. The profile is mounted on a standard aluminium C rail. A control unit is not included. This edge is intended to be used in series with another length of edge which has a terminating resistor.

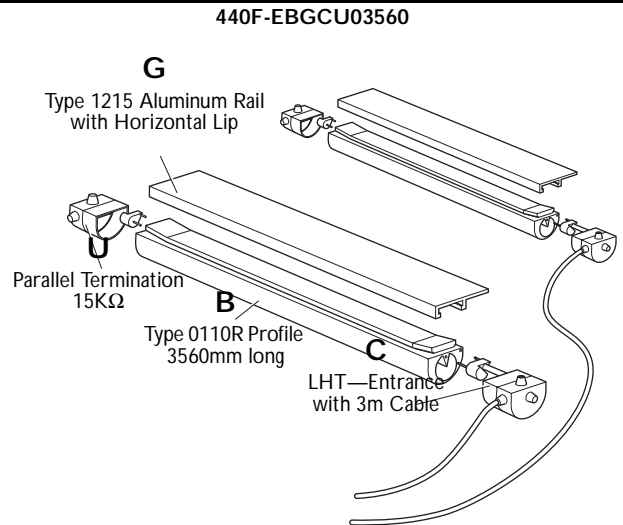

This is a red-coloured single profile which is 3560mm long. This profile is part of a parallel profile system, for ease of mounting, as it is terminated with a Parallel Termination. A 3m cable enters into the left side of the closing cap from a plastic surface mount controller. The profile is mounted on an aluminium C Rail with a horizontal lip for ease of mounting. The horizontal lip can be reversed by the user by sliding the profile out of the C Rail, rotating the C Rail and then re-inserting the profile back into the C Rail. A separate catalogue number must be entered for the other profile.