

Micro850 48 Point Programmable Controllers

Catalog Numbers 2080-LC50-48AWB, 2080-LC50-48QWB, 2080-LC50-48QBB, 2080-LC50-48QVB

<http://rockwellautomation.com/literature>

<p>FR Cette publication est disponible en français sous forme électronique (fichier PDF). Pour la télécharger, rendez-vous sur la page Internet indiquée ci-dessus.</p>	<p>PT Esta publicação está disponível em português como PDF. Vá ao endereço web que aparece acima para encontrar e fazer download da publicação.</p>
<p>IT Questa pubblicazione è disponibile in Italiano in formato PDF. Per scaricarla collegarsi al sito Web indicato sopra.</p>	<p>ZH 本出版物备有中文PDF格式文件，可从上面的网址找到并下载本出版物。</p>
<p>DE Diese Publikation ist als PDF auf Deutsch verfügbar. Gehen Sie auf die oben genannte Web-Adresse, um nach der Publikation zu suchen und sie herunterzuladen.</p>	<p>ZC 本出版物備有中文PDF檔，可由上列網址下載。</p>
<p>ES Esta publicación está disponible en español como PDF. Diríjase a la dirección web indicada arriba para buscar y descarga esta publicación.</p>	<p>KO 큰 간행물은 한글판 PDF 파일로 준비되어 있습니다. 위에 있는 웹사이트에 가서서 간행물을 다운로드 하십시오.</p>

Table of Contents

Topic	Page
Important User Information	2
Additional Resources	7
Overview	8
Controller Description	8
Status Indicator	9
Mount the Module	9
Wire the Controller	12
Specifications	14

Important User Information

Solid state equipment has operational characteristics differing from those of electromechanical equipment. Safety Guidelines for the Application, Installation and Maintenance of Solid State Controls (Publication [SGI-1.1](#) available from your local Rockwell Automation sales office or online at <http://rockwellautomation.com/literature>) describes some important differences between solid state equipment and hard-wired electromechanical devices. Because of this difference, and also because of the wide variety of uses for solid state equipment, all persons responsible for applying this equipment must satisfy themselves that each intended application of this equipment is acceptable.





In no event will Rockwell Automation, Inc. be responsible or liable for indirect or consequential damages resulting from the use or application of this equipment.

The examples and diagrams in this manual are included solely for illustrative purposes. Because of the many variables and requirements associated with any particular installation, Rockwell Automation, Inc. cannot assume responsibility or liability for actual use based on the examples and diagrams.

No patent liability is assumed by Rockwell Automation, Inc. with respect to use of information, circuits, equipment, or software described in this manual.

Reproduction of the contents of this manual, in whole or in part, without written permission of Rockwell Automation, Inc., is prohibited.

Throughout this manual, when necessary, we use notes to make you aware of safety considerations.

	<p>WARNING: Identifies information about practices or circumstances that can cause an explosion in a hazardous environment, which may lead to personal injury or death, property damage, or economic loss.</p>
	<p>ATTENTION: Identifies information about practices or circumstances that can lead to personal injury or death, property damage, or economic loss. Attentions help you identify a hazard, avoid a hazard and recognize the consequences.</p>
	<p>SHOCK HAZARD: Labels may be on or inside the equipment (for example, drive or motor) to alert people that dangerous voltage may be present.</p>
	<p>BURN HAZARD: Labels may be on or inside the equipment (for example, drive or motor) to alert people that surfaces may reach dangerous temperatures.</p>
<p>IMPORTANT</p>	<p>IMPORTANT: Identifies information that is critical for successful application and understanding of the product.</p>

Environment and Enclosure



ATTENTION: This equipment is intended for use in a Pollution Degree 2 industrial environment, in overvoltage Category II applications (as defined in IEC 60664-1), at altitudes up to 2000 m (6562 ft) without derating. This equipment is considered Group 1, Class A industrial equipment according to IEC/CISPR 11. Without appropriate precautions, there may be difficulties with electromagnetic compatibility in residential and other environments due to conducted and radiated disturbances.

This equipment is supplied as open-type equipment. It must be mounted within an enclosure that is suitably designed for those specific environmental conditions that will be present and appropriately designed to prevent personal injury resulting from accessibility to live parts. The enclosure must have suitable flame-retardant properties to prevent or minimize the spread of flame, complying with a flame spread rating of 5VA or be approved for the application if nonmetallic. The interior of the enclosure must be accessible only by the use of a tool. Subsequent sections of this publication may contain additional information regarding specific enclosure type ratings that are required to comply with certain product safety certifications.

In addition to this publication, see:

- Industrial Automation Wiring and Grounding Guidelines, Rockwell Automation publication [1770-4.1](#), for additional installation requirements.
- NEMA Standard 250 and IEC 60529, as applicable, for explanations of the degrees of protection provided by different types of enclosure.

Preventing Electrostatic Discharge





ATTENTION: This equipment is sensitive to electrostatic discharge, which can cause internal damage and affect normal operation. Follow these guidelines when you handle this equipment:

- Touch a grounded object to discharge potential static.
 - Wear an approved grounding wriststrap.
 - Do not touch connectors or pins on component boards.
 - Do not touch circuit components inside the equipment.
 - Use a static-safe workstation, if available.
 - Store the equipment in appropriate static-safe packaging when not in use.
-

North American Hazardous Location Approval

The following modules are North American Hazardous Location approved:
 2080-LC50-48AWB, 2080-LC50-48QWB, 2080-LC50-48QBB, 2080-LC50-48QVB

The following information applies when operating this equipment in hazardous locations:	Informations sur l'utilisation de cet équipement en environnements dangereux:
<p>Products marked "CL I, DIV 2, GP A, B, C, D" are suitable for use in Class I Division 2 Groups A, B, C, D, Hazardous Locations and nonhazardous locations only. Each product is supplied with markings on the rating nameplate indicating the hazardous location temperature code. When combining products within a system, the most adverse temperature code (lowest "T" number) may be used to help determine the overall temperature code of the system. Combinations of equipment in your system are subject to investigation by the local Authority Having Jurisdiction at the time of installation.</p>	<p>Les produits marqués "CL I, DIV 2, GP A, B, C, D" ne conviennent qu'à une utilisation en environnements de Classe I Division 2 Groupes A, B, C, D dangereux et non dangereux. Chaque produit est livré avec des marquages sur sa plaque d'identification qui indiquent le code de température pour les environnements dangereux. Lorsque plusieurs produits sont combinés dans un système, le code de température le plus défavorable (code de température le plus faible) peut être utilisé pour déterminer le code de température global du système. Les combinaisons d'équipements dans le système sont sujettes à inspection par les autorités locales qualifiées au moment de l'installation.</p>
<div style="display: flex; align-items: center;">  <div> <p>WARNING: EXPLOSION HAZARD</p> <ul style="list-style-type: none"> • Do not disconnect equipment unless power has been removed or the area is known to be nonhazardous. • Do not disconnect connections to this equipment unless power has been removed or the area is known to be nonhazardous. Secure any external connections that mate to this equipment by using screws, sliding latches, threaded connectors, or other means provided with this product. • Substitution of any component may impair suitability for Class I, Division 2. • If this product contains batteries, they must only be changed in an area known to be nonhazardous. </div> </div>	<div style="display: flex; align-items: center;">  <div> <p>AVERTISSEMENT: RISQUE D'EXPLOSION</p> <ul style="list-style-type: none"> • Couper le courant ou s'assurer que l'environnement est classé non dangereux avant de débrancher l'équipement. • Couper le courant ou s'assurer que l'environnement est classé non dangereux avant de débrancher les connecteurs. Fixer tous les connecteurs externes reliés à cet équipement à l'aide de vis, loquets coulissants, connecteurs filetés ou autres moyens fournis avec ce produit. • La substitution de tout composant peut rendre cet équipement inadapté à une utilisation en environnement de Classe I, Division 2. • S'assurer que l'environnement est classé non dangereux avant de changer les piles. </div> </div>

**WARNING:**

- When used in a Class I, Division 2, hazardous location, this equipment must be mounted in a suitable enclosure with proper wiring method that complies with the governing electrical codes.
 - If you connect or disconnect the serial cable with power applied to this module or the serial device on the other end of the cable, an electrical arc can occur. This could cause an explosion in hazardous location installations. Be sure that power is removed or the area is nonhazardous before proceeding.
 - If you connect or disconnect the communications cable with power applied to this module or any device on the network, an electrical arc can occur. This could cause an explosion in hazardous location installations. Be sure that power is removed or the area is nonhazardous before proceeding.
 - The local programming terminal port is intended for temporary use only and must not be connected or disconnected unless the area is assured to be nonhazardous.
 - The USB port is intended for temporary local programming purposes only and not intended for permanent connection. If you connect or disconnect the USB cable with power applied to this module or any device on the USB network, an electrical arc can occur. This could cause an explosion in hazardous location installations. Be sure that power is removed or the area is nonhazardous before proceeding.
The USB port is a nonincendive field wiring connection for Class I, Division2 Groups A, B, C and D.
 - Exposure to some chemicals may degrade the sealing properties of materials used in the Relays. It is recommended that the User periodically inspect these devices for any degradation of properties and replace the module if degradation is found.
 - If you insert or remove the plug-in module while backplane power is on, an electrical arc can occur. This could cause an explosion in hazardous location installations. Be sure that power is removed or the area is nonhazardous before proceeding.
Refer to the Wiring Diagram for each plug-in module for additional details regarding removal or insertion under power
 - When you change switch settings while power is on, an electrical arc can occur. This could cause an explosion in hazardous location installations. Be sure that power is removed or the area is nonhazardous before proceeding.
 - When you connect or disconnect the Removable Terminal Block (RTB) with field side power applied, an electrical arc can occur. This could cause an explosion in hazardous location installations. Be sure that power is removed or the area is nonhazardous before proceeding.s
-



ATTENTION:

- To comply with the CE Low Voltage Directive (LVD), this equipment must be powered from a source compliant with the following: Safety Extra Low Voltage (SELV) or Protected Extra Low Voltage (PELV).
 - To comply with UL restrictions, this equipment must be powered from a Class 2 or Limited Voltage Limited Current Source (LVLC).
-



ATTENTION:

- The USB and serial cables are not to exceed 3.0 m (9.84 ft).
 - Do not wire more than 2 conductors on any single terminal.
 - Do not remove the Removable Terminal Block (RTB) until power is removed.
 - Do not connect directly to line voltage. Line voltage must be supplied by a suitable, approved isolating transformer or power supply having short circuit capacity not exceeding 100 VA maximum or equivalent.
 - For Class I Division 2 applications, use only Class I Division 2 listed or recognized accessories and modules approved for use within the Micro800® platform.
-



ATTENTION:

- Electrostatic discharge can damage semiconductor devices inside the module. Do not touch the connector pins or other sensitive areas.
 - Do not remove the protective debris strips until after the controller and all other equipment in the panel near the module are mounted and wired. Remove strips before operating the controller. Failure to remove strips before operating can cause overheating.
 - Be careful when stripping wires. Wire fragments that fall into the controller could cause damage. Once wiring is complete, make sure the controller is free of all metal fragments.
-

Additional Resources

Resource	Description
Micro830 [®] and Micro850 [®] Programmable Controllers User Manual, publication 2080-UM002	A more detailed description of how to install and use your Micro830 and Micro850 programmable controller.
Micro800 [®] AC Power Supply Installation Instructions, publication 2080-IN001	Information on wiring and installing the optional AC power supply.
Micro800 Plug-in Modules User Manual, publication 2080-UM004	Installation, wiring descriptions, and specifications for the Micro800 plug-in modules.
Micro850 Expansion I/O Modules User Manual, publication 2080-UM003	Installation, wiring descriptions, and specifications for the Micro850 expansion I/O modules.
Industrial Automation Wiring and Grounding Guidelines, publication 1770-4.1	More information on proper wiring and grounding techniques.

If you would like a manual, you can:

- download a free electronic version from the Internet:
<http://rockwellautomation.com/literature>
- purchase a printed manual by contacting your local Allen-Bradley distributor or Rockwell Automation representative

Overview

The Micro850 48-point controller is an expandable brick style controller with embedded inputs and outputs. It can accommodate up to five plug-in modules and accommodates any 24V DC output power supply that meets minimum specifications such as the optional Micro800 power supply, 2080-PS120-240VAC.

Controller Overview

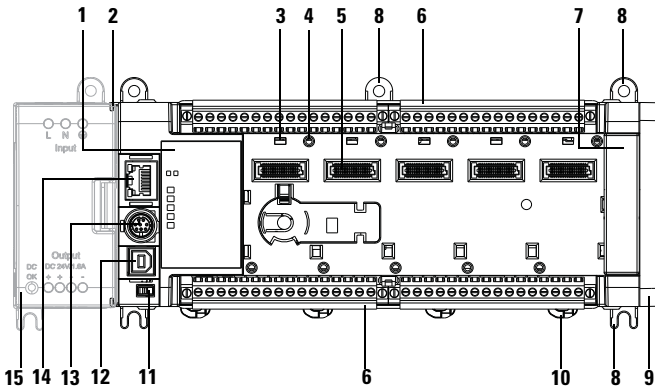

45915

Controller Description

	Description		Description
1	Status indicators	9	Expansion I/O slot cover
2	Optional power supply slot	10	DIN rail mounting latch
3	Plug-in latch	11	Mode switch
4	Plug-in screw hole	12	Type B connector USB port
5	40 pin high speed plug-in connector	13	RS232/RS485 non-isolated combo serial port
6	Removable I/O terminal block	14	RJ-45 EtherNet/IP connector (with embedded yellow and green LEDs)
7	Right-side cover	15	Optional AC power supply (for example: 2080-PS120-240VAC)
8	Mounting screw hole / mounting foot		

Status Indicator

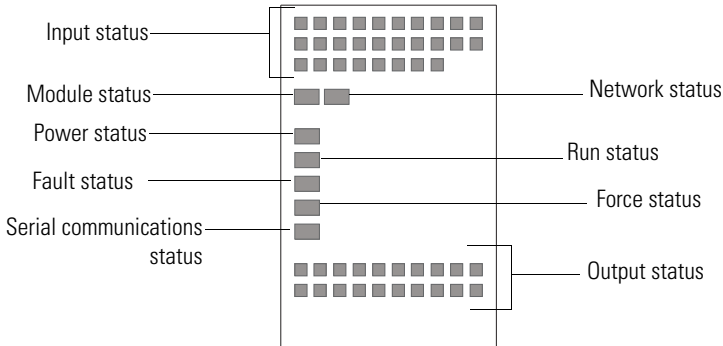

45037

Mount the Module

Most applications require installation in an industrial enclosure to reduce the effects of electrical interference and environmental exposure. Locate your controller as far as possible from power lines, load lines, and other sources of electrical noise such as hard-contact switches, relays, and AC motor drives. For more information on proper grounding guidelines, see the Industrial Automation Wiring and Grounding Guidelines, publication [1770-4.1](#).

Mounting Dimensions and DIN Rail Mounting

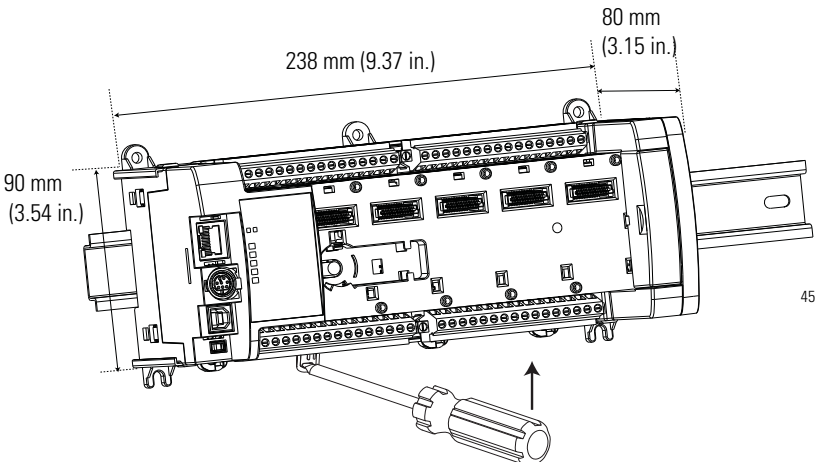

45916

Mounting dimensions do not include mounting feet or DIN rail latches.

Module Spacing

Maintain spacing from objects such as enclosure walls, wireways and adjacent equipment. Allow 50.8 mm (2 in.) of space on all sides for adequate ventilation. If optional accessories/modules are attached such as the power supply 2080-PS120-240VAC or expansion I/O modules, make sure that there is 50.8 mm (2 in.) of space on all sides after attaching the optional parts.

DIN Rail Mounting

The module can be mounted using the following DIN rails: 35 x 7.5 mm x 1 mm (EN 50 022 - 35 x 7.5).

TIP For environments with greater vibration and shock concerns, use the panel mounting method, instead of DIN rail mounting.

Before mounting the module on a DIN rail, use a flat-blade screwdriver in the DIN rail latch and pry it downwards until it is in the unlatched position.

1. Hook the top of the DIN rail mounting area of the controller onto the DIN rail, and then press the bottom until the controller snaps onto the DIN rail.
2. Push the DIN rail latch back into the latched position.
Use DIN rail end anchors (Allen-Bradley part number 1492-EA35 or 1492-EAHJ35) for vibration or shock environments.

To remove your controller from the DIN rail, pry the DIN rail latch downwards until it is in the unlatched position.

Panel Mounting

The preferred mounting method is to use four M4 (#8) screws per module. Hole spacing tolerance: ± 0.4 mm (0.016 in.).

Follow these steps to install your controller using mounting screws.

1. Place the controller against the panel where you are mounting it. Make sure the controller is spaced properly.
2. Mark drilling holes through the mounting screw holes and mounting feet then remove the controller.
3. Drill the holes at the markings, then replace the controller and mount it.
Leave the protective debris strip in place until you are finished wiring the controller and any other devices.

Panel Mounting Dimensions

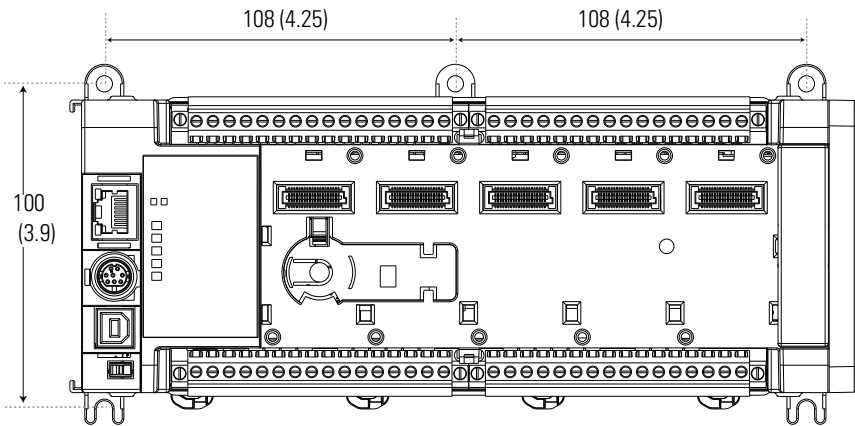

Measurements are in millimeters (inches)

45917

Use Surge Suppressors

Because of the potentially high current surges that occur when switching inductive load devices, such as motor starters and solenoids, we recommend the use of some type of surge suppression to protect and extend the operating life of the controllers output contacts. Switching inductive loads without surge suppression can *significantly* reduce the life expectancy of relay contacts. By adding a suppression device directly across the coil of an inductive device, you prolong the life of the output or relay contacts. You also reduce the effects of voltage transients and electrical noise from radiating into adjacent systems.

Refer to the Micro830 and Micro850 Programmable Controllers User Manual, publication [2080-UM002](#), for suitable surge suppression methods and recommended surge suppressors.

Expansion I/O and Plug-in Module Installation

To attach expansion I/O and plug-in modules to your Micro850 controller, see the installation manual and/or wiring diagrams specific to your plug-ins and expansion I/O.

Installation Instructions are available in the Literature Library, <http://rockwellautomation.com/literature>.

Wire the Controller

2080-LC50-48AWB / 2080-LC50-48QWB

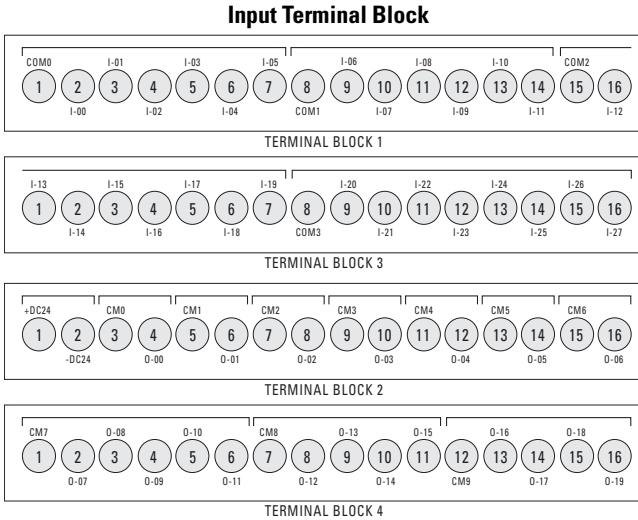

2080-LC50-48QVB / 2080-LC50-48QBB

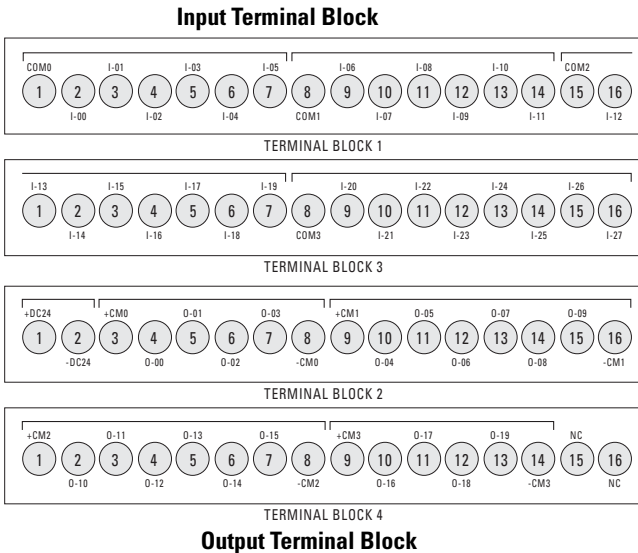

Control Drawing for Class 1 Division 2 Applications

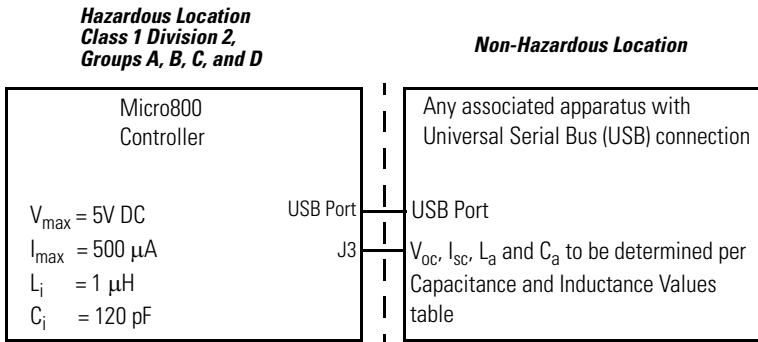

Capacitance and Inductance Values

Nonincendive Equipment	Associated Apparatus
V_{max} (or U_i) \geq	V_{oc} or V_t (or U_o)
I_{max} (or L_i) \geq	I_{sc} or I_t (or I_o)
$C_i + C_{cable} \leq$	C_a (or C_o)
$L_i + L_{cable} \leq$	L_a (or L_o)

Capacitance and Inductance of the field wiring from the nonincendive equipment to the associated apparatus shall be calculated and must be included in the system calculations as shown in the table above.

Where the cable capacitance and inductance per foot are not known, the following values shall be used: $C_{cable} = 60$ pF/ft, $L_{cable} = 0.2$ μH /ft.

Wiring method must be in accordance with ANSI/NFPA70.

Specifications

General Specifications

Attribute	2080-LC50			
	-48AWB	-48QWB	-48QVB	-48QBB
Number of I/O	48 (28 inputs, 20 outputs)			
Dimensions HxWxD	90 x 238 x 80 mm (3.54 x 9.37 x 3.15 in.)			
Shipping weight, approx.	0.725 kg (1.60 lb)			
Wire size				
		Min	Max	
	Solid and Stranded	0.2 mm ² (24 AWG)	2.5 mm ² (14 AWG)	rated @ 90 °C (194 °F) insulation max
Wiring category ⁽¹⁾	2 – on signal ports 2 – on power ports 2 – on communication ports			
Wire type	Use Copper Conductors only			
Terminal screw torque	0.4...0.5 Nm (3.5...4.4 lb-in.) using a 0.6 x 3.5 mm flat-blade screwdriver.			
Input circuit type	120V AC	12/24V sink/source (standard) 24V sink/source (high-speed)		
Output circuit type	Relay		24V DC sink (standard and high-speed)	24V DC source (standard and high-speed)
Power consumption	33 W			
Power supply voltage range	20.4...26.4V DC Class 2, or Limited Voltage Limited Current Source (LVLC)			
I/O rating	Input 120V AC, 16 mA Output 2 A, 240V AC, 2 A, 24V DC	Input 24V, 8.8 mA Output 2 A, 240V AC, 2 A, 24V DC	Input 24V, 8.8 mA Output 24V DC, 1 A per point (surrounding air temperature 30 °C) 24V DC, 0.3 A per point (surrounding air temperature 65 °C)	
Insulation stripping length	7 mm (0.28 in.)			
Enclosure type rating	Meets IP20			

General Specifications

Attribute	2080-LC50			
	-48AWB	-48QWB	-48QVB	-48QBB
Pilot duty rating	C300, R150			—
Isolation voltage	250V (continuous), Reinforced Insulation Type, Output to Aux and Network, Inputs to Outputs. Type tested for 60 s @ 3250V DC Output to Aux and Network, Inputs to Outputs. 150V (continuous), Reinforced Insulation Type, Input to Aux and Network Type tested for 60 s @ 1950V DC Input to Aux and Network.	250V (continuous), Reinforced Insulation Type, Output to Aux and Network, Inputs to Outputs. Type tested for 60 s @ 3250V DC Output to Aux and Network, Inputs to Outputs. 50V (continuous), Reinforced Insulation Type, Input to Aux and Network Type tested for 60 s @ 720V DC, Inputs to Aux and Network.	50V (continuous), Reinforced Insulation Type, I/O to Aux and Network, Inputs to Outputs. Type tested for 60 s @ 720V DC, I/O to Aux and Network, Inputs to Outputs.	
North American temp code	T4			

⁽¹⁾ Use this Conductor Category information for planning conductor routing. Refer to Industrial Automation Wiring and Grounding Guidelines, publication [1770-4.1](#).

Input Specifications

Attribute	2080-LC50-48AWB	2080-LC50-48QWB / 2080-LC50-48QVB / 2080-LC50-48QBB	
	120V AC Input	High Speed DC Input (Inputs 0...11)	Standard DC Input (Inputs 12 and higher)
Number of inputs	28	12	16
Input group to backplane isolation	Verified by the following dielectric tests: 1950V AC for 2 s 150V working voltage (IEC Class 2 reinforced insulation)	Verified by the following dielectric tests: 720V DC for 2 s 50V DC working voltage (IEC Class 2 reinforced insulation)	
Voltage category	110V AC	12/24V sink/source (standard) 24V sink/source (high-speed)	
Operating voltage range	132V, 60Hz AC max	16.8...26.4V DC @ 65°C (149°F) 16.8...30.0V DC @ 30°C (86°F)	10...26.4V DC @ 65°C (149°F) 10...30.0V DC @ 30°C (86°F)
Off-state voltage, max	20V AC	5V DC	
Off-state current, max	1.5 mA	1.5 mA	
On-state current, min	5 mA @ 79V AC	5.0 mA @ 16.8V DC	1.8 mA @ 10V DC
On-state current, nom	12 mA @ 120V AC	7.6 mA @ 24V DC	6.15 mA @ 24V DC
On-state current, max	16 mA @ 132V AC	12.0 mA @ 30V DC	
Nominal impedance	12 k Ω @ 50 Hz 10 k Ω @ 60 Hz	3 k Ω	3.74 k Ω
IEC input compatibility	Type 3		
Inrush current, max	250 mA @ 120V AC	—	
Input frequency, max	63 Hz	—	

IMPORTANT

For 24V AC specifications, refer to the Micro830 and Micro850 User Manual, publication [2080-UM002](#).

Output Specifications

Attribute	2080-LC50-48AWB / 2080-LC50-48QWB		2080-LC50-48QVB / 2080-LC50-48QBB	
	Relay Output	High Speed Output (Outputs 0...3)	Standard Output (Outputs 4 and higher)	
Number of outputs	20	4	16	
Output voltage, min	5V DC, 5V AC	10.8V DC	10V DC	
Output voltage, max	125V DC, 265V AC	26.4V DC	26.4V DC	
Load current, min	10 mA			
Load current, continuous, max	2.0 A	100 mA (high-speed operation) 1.0 A @ 30 °C 0.3 A @ 65 °C (standard operation)	1.0 A @ 30 °C 0.3 A @ 65 °C (standard operation)	
Surge current, per point	See Relay Contacts Ratings on page 17	4.0 A for 10 ms every 1 s @ 30 °C; every 2 s @ 65 °C ⁽¹⁾		
Current, per common, max	5A	–	–	
Turn on time/ Turn off time, max	10 ms	2.5 μs	0.1 ms 1 ms	

⁽¹⁾ Applies for general purpose operation only. Does not apply for high-speed operation.

Relay Contacts Ratings

Maximum Volts	Amperes		Amperes Continuous	Volt-Amperes	
	Make	Break		Make	Break
120V AC	15 A	1.5 A	2.0 A	1800V A	180V A
240V AC	7.5 A	0.75 A			
24V DC	1.0 A		1.0 A	28V A	
125V DC	0.22 A				

Environmental Specifications

Attribute	Value
Temperature, operating	IEC 60068-2-1 (Test Ad, Operating Cold), IEC 60068-2-2 (Test Bd, Operating Dry Heat), IEC 60068-2-14 (Test Nb, Operating Thermal Shock): -20...65 °C (-4...149 °F)
Temperature, surrounding air, max	65 °C (149 °F)
Temperature, non-operating	IEC 60068-2-1 (Test Ab, Unpackaged Nonoperating Cold), IEC 60068-2-2 (Test Bb, Unpackaged Nonoperating Dry Heat), IEC 60068-2-14 (Test Na, Unpackaged Nonoperating Thermal Shock): -40...85 °C (-40...185 °F)
Relative humidity	IEC 60068-2-30 (Test Db, Unpackaged Damp Heat): 5...95% non-condensing
Vibration	IEC 60068-2-6 (Test Fc, Operating): 2 g @ 10...500 Hz
Shock, operating	IEC 60068-2-27 (Test Ea, Unpackaged Shock): 25 g
Shock, non-operating	IEC 60068-2-27 (Test Ea, Unpackaged Shock): DIN mount: 25 g PANEL mount: 35 g
Emissions	CISPR 11 Group 1, Class A
ESD immunity	IEC 61000-4-2: 6 kV contact discharges 8 kV air discharges
Radiated RF immunity	IEC 61000-4-3: 10V/m with 1 kHz sine-wave 80% AM from 80...2000 MHz 10V/m with 200 Hz 50% Pulse 100% AM @ 900 MHz 10V/m with 200 Hz 50% Pulse 100% AM @ 1890 MHz 10V/m with 1 kHz sine-wave 80% AM from 2000...2700 MHz
EFT/B immunity	IEC 61000-4-4: ±2 kV @ 5 kHz on power ports ±2 kV @ 5 kHz on signal ports ±1 kV @ 5 kHz on communication ports
Surge transient immunity	IEC 61000-4-5: ±1 kV line-line(DM) and ±2 kV line-earth(CM) on power ports ±1 kV line-line(DM) and ±2 kV line-earth(CM) on signal ports ±1 kV line-earth(CM) on communication ports
Conducted RF immunity	IEC 61000-4-6: 10V rms with 1 kHz sine-wave 80% AM from 150 kHz...80 MHz

Certifications

Certification (when product is marked) ⁽¹⁾	Value
c-UL-us	UL Listed Industrial Control Equipment, certified for US and Canada. See UL File E322657. UL Listed for Class I, Division 2 Group A,B,C,D Hazardous Locations, certified for U.S. and Canada. See UL File E334470.
CE	European Union 2004/108/EC EMC Directive, compliant with: EN 61326-1; Meas./Control/Lab., Industrial Requirements EN 61000-6-2; Industrial Immunity EN 61000-6-4; Industrial Emissions EN 61131-2; Programmable Controllers (Clause 8, Zone A & B) European Union 2006/95/EC LVD, compliant with: EN 61131-2; Programmable Controllers (Clause 11)
C-Tick	Australian Radiocommunications Act, compliant with: AS/NZS CISPR 11; Industrial Emissions
EtherNet/IP	ODVA conformance tested to EtherNet/IP specifications.
KC	Korean Registration of Broadcasting and Communications Equipment, compliant with: Article 58-2 of Radio Waves Act, Clause 3.

⁽¹⁾ See the Product Certification link at <http://www.rockwellautomation.com/products/certification> for Declaration of Conformity, Certificates, and other certification details.

Rockwell Automation Support

Rockwell Automation provides technical information on the Web to assist you in using its products. At <http://support.rockwellautomation.com>, you can find technical manuals, a knowledge base of FAQs, technical and application notes, sample code and links to software service packs, and a MySupport feature that you can customize to make the best use of these tools.

For an additional level of technical phone support for installation, configuration and troubleshooting, we offer TechConnect support programs. For more information, contact your local distributor or Rockwell Automation representative, or visit <http://support.rockwellautomation.com>.

Installation Assistance

If you experience a problem within the first 24 hours of installation, please review the information that's contained in this manual. You can also contact a special Customer Support number for initial help in getting your product up and running.

United States	1.440.646.3434 Monday – Friday, 8 a.m. – 5 p.m. EST
Outside United States	Please contact your local Rockwell Automation representative for any technical support issues.

New Product Satisfaction Return

Rockwell Automation tests all of its products to ensure that they are fully operational when shipped from the manufacturing facility. However, if your product is not functioning and needs to be returned, follow these procedures.

United States	Contact your distributor. You must provide a Customer Support case number (call the phone number above to obtain one) to your distributor in order to complete the return process.
Outside United States	Please contact your local Rockwell Automation representative for the return procedure.

Allen-Bradley, Rockwell Automation, Micro800, Micro830, Micro850, and TechConnect are trademarks of Rockwell Automation, Inc.

Trademarks not belonging to Rockwell Automation are property of their respective companies.

Rockwell Otomasyon Ticaret A.Ş., Kar Plaza İş Merkezi E Blok Kat:6 34752 İçerenköy, İstanbul, Tel: +90 (216) 5698400

www.rockwellautomation.com

Power, Control and Information Solutions Headquarters

Americas: Rockwell Automation, 1201 South Second Street, Milwaukee, WI 53204-2496 USA, Tel: (1) 414.382.2000, Fax: (1) 414.382.4444
Europe/Middle East/Africa: Rockwell Automation, Vordriem/Boulevard du Souverain 36, 1170 Brussels, Belgium, Tel: (32) 2.663.0800, Fax: (32) 2.663.0640
Asia Pacific: Rockwell Automation, Level 14, Core F, Cyberport 3, 100 Cyberport Road, Hong Kong, Tel: (852) 2887 4788, Fax: (852) 2508 1846

Publication 2080-IN008B-EN-P - April 2014

Supersedes Publication 2080-IN008A-EN-P - September 2012

PN-244667

Copyright © 2014 Rockwell Automation, Inc. All rights reserved. Printed in Singapore.