



**Allen-Bradley**

**PowerFlex™**  
Communications

# Smart Self-powered Serial Converter

1203-SSS (Series B)  
FRN 3.xxx

User Manual

**Rockwell  
Automation**

## Important User Information

Because of the variety of uses for the products described in this publication, those responsible for the application and use of this control equipment must satisfy themselves that all necessary steps have been taken to assure that each application and use meets all performance and safety requirements, including any applicable laws, regulations, codes and standards.

The illustrations, charts, sample programs and layout examples shown in this guide are intended solely for purposes of example. Since there are many variables and requirements associated with any particular installation, Allen-Bradley does not assume responsibility or liability (to include intellectual property liability) for actual use based upon the examples shown in this publication.

Allen-Bradley publication SGI-1.1, *Safety Guidelines for the Application, Installation and Maintenance of Solid-State Control* (available from your local Allen-Bradley office or online at <http://www.ab.com/manuals/gi>), describes some important differences between solid-state equipment and electromechanical devices that should be taken into consideration when applying products such as those described in this publication.

Reproduction of the contents of this copyrighted publication, in whole or part, without written permission of Rockwell Automation, is prohibited.

Throughout this manual we use notes to make you aware of safety considerations:



**ATTENTION:** Identifies information about practices or circumstances that can lead to personal injury or death, property damage or economic loss.

---

Attention statements help you to:

- identify a hazard
- avoid a hazard
- recognize the consequences

**Important:** Identifies information that is critical for successful application and understanding of the product.



**TIP:** Identifies information that is helpful, but not necessary, in completing a task.

# Summary of Changes

---

The information below summarizes the changes to the serial converter and documentation since its last release.

## Serial Converter Changes

The 1203-SSS Smart Self-powered Serial Converter (FRN 3.xxx) can now be used with products implementing DPI™ in addition to products implementing SCANport™. DPI is a functional enhancement to SCANport and is used by some Allen-Bradley products, including those in the PowerFlex™ family of drives.

Use the following software versions with the 1203-SSS (FRN 3.xxx) to fully utilize DPI host products such as PowerFlex Drives:

Software	Version
DriveExplorer™	v2.01 or higher
DriveTools 2000™	v1.xx or higher

The following software versions can be used with the 1203-SSS (FRN 3.xxx) to fully utilize SCANport host products such as the 1305, 1336 PLUS II, etc.:

Software	Version
DriveExplorer	v1.01 or higher
DriveTools32™	v2.01 or higher

## Documentation Changes

This manual supersedes Publication 1203-5.15 - August 1999. It contains all information that was in that manual. In addition, it contains the following changes and new information:

Location	Description of Changes
Chapter 1	Information about DPI products has been added. In addition, information has been rearranged.
Chapter 3	Instructions for using the PowerFlex HIM to access serial converter parameters have been added.
Chapter 4	Events on DPI connections have been added.
Appendix B	Parameters have been updated to reflect the changes to the serial converter parameters.
Appendix C	New flash instructions have been added to describe flashing PowerFlex drives and peripherals.

**Notes:**

# Table of Contents

---

<b>Preface</b>	<b>About This Manual</b>	
	Related Documentation . . . . .	P-1
	Conventions Used in this Manual . . . . .	P-1
	Rockwell Automation Support . . . . .	P-2
<b>Chapter 1</b>	<b>Getting Started</b>	
	Components . . . . .	1-1
	Features . . . . .	1-2
	Compatible Products . . . . .	1-2
	Required Equipment . . . . .	1-3
	Safety Precautions . . . . .	1-4
	Quick Start . . . . .	1-5
	Modes of Operation . . . . .	1-6
<b>Chapter 2</b>	<b>Installing the Serial Converter</b>	
	Selecting Cables . . . . .	2-1
	Installing the Serial Converter . . . . .	2-2
	Removing the Serial Converter . . . . .	2-2
<b>Chapter 3</b>	<b>Configuring the Serial Converter</b>	
	Configuration Tools . . . . .	3-1
	Using the PowerFlex HIM . . . . .	3-2
	Using DriveExplorer . . . . .	3-3
	Using Terminal Emulation Software . . . . .	3-4
	Setting the Serial Port Rate . . . . .	3-8
	Setting the Fault Action . . . . .	3-9
	Resetting the Serial Converter . . . . .	3-10
<b>Chapter 4</b>	<b>Troubleshooting</b>	
	Understanding the Status Indicators . . . . .	4-1
	Module Diagnostic Items . . . . .	4-3
	Viewing and Clearing the Event Queue . . . . .	4-3
	Viewing and Clearing DF1 Communication Statistics . . . . .	4-6
	Troubleshooting Potential Problems . . . . .	4-7
<b>Appendix A</b>	<b>Specifications</b>	
	Communications . . . . .	A-1
	Electrical . . . . .	A-1
	Mechanical . . . . .	A-1
	Environmental . . . . .	A-2
	Regulatory Compliance . . . . .	A-2

**Appendix B Serial Converter Parameters**  
Parameter List ..... B-1

**Appendix C Flash Updates**  
Preparing for a Flash Update ..... C-1  
Performing a Flash Update with HyperTerminal ..... C-2  
Troubleshooting Potential Flash Problems ..... C-4

**Glossary**

**Index**

## About This Manual

Read this preface to become familiar with the rest of the manual.

Topic	Page
<a href="#">Related Documentation</a>	<a href="#">P-1</a>
<a href="#">Conventions Used in this Manual</a>	<a href="#">P-1</a>
<a href="#">Rockwell Automation Support</a>	<a href="#">P-2</a>

### Related Documentation

For Information On:	Refer to:	Publication
DF1 Protocol	<i>DF1 Protocol and Command Set Reference manual</i>	1770-6.5.16
DriveTools 2000	<i>DriveTools 2000 Online Help</i>	–
DriveTools32	<i>DriveTools32 Getting Started Manual</i>	9303-5.23
DriveExplorer	<i>DriveExplorer Getting Results Manual</i>	9306-5.2

Documentation can be obtained online at <http://www.ab.com/manuals>.

### Conventions Used in this Manual

The following conventions are used throughout this manual:

- Parameter names follow the format **Parameter xxx - [\*]**. The xxx represents the parameter number. The \* represents the parameter name. For example, **Parameter 01 - [Adapter Port]**.
- Menu commands are shown in bold type face and follow the format **Menu > Command**. For example, if you read “Select **File > Open**,” you should click the **File** menu and then click the **Open** command.
- The firmware release is displayed as FRN X.xxx. The “FRN” is the Firmware Release Number. The “X” represents the Major Release Number. The “xxx” represents the Minor Release Number. This manual is for Firmware releases 3.xxx.

## Rockwell Automation Support

Rockwell Automation offers support services worldwide, with over 75 sales/support offices, over 500 authorized distributors, and over 250 authorized systems integrators located through the United States alone. In addition, Rockwell Automation representatives are in every major country in the world.

### Local Support

Contact your local Rockwell Automation representative for:

- Sales and order support.
- Technical training.
- Warranty support.
- Support service agreements.

### Technical Assistance

If you need to contact Rockwell Automation for technical assistance, please review the information in [Chapter 4, Troubleshooting](#) first. If you still have questions, then contact your local Rockwell Automation representative.



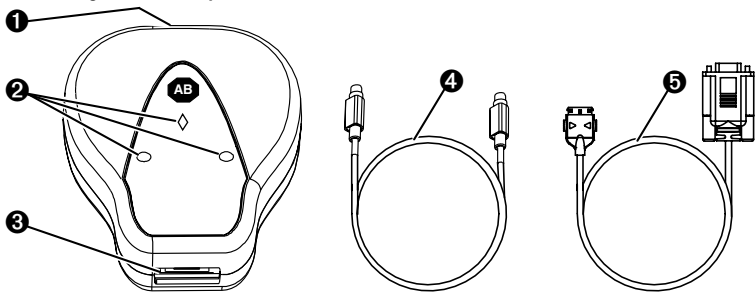
## Getting Started

The 1203-SSS serial converter provides an electronic communications interface between a computer and any Allen-Bradley product implementing SCANport or DPI. It uses the full-duplex, RS-232 DF-1 protocol.

Topic	Page	Topic	Page
<a href="#">Components</a>	<a href="#">1-1</a>	<a href="#">Safety Precautions</a>	<a href="#">1-4</a>
<a href="#">Features</a>	<a href="#">1-2</a>	<a href="#">Quick Start</a>	<a href="#">1-5</a>
<a href="#">Compatible Products</a>	<a href="#">1-2</a>	<a href="#">Modes of Operation</a>	<a href="#">1-6</a>
<a href="#">Required Equipment</a>	<a href="#">1-3</a>		

### Components

Figure 1.1 Components of the Serial Converter



#	Part	Description
①	SCANport/DPI Connection	Standard SCANport/DPI 8-pin circular mini-DIN connector. The 1202-C10 cable is plugged into this connector.
②	Status Indicators	LEDs that indicate module operation, data is being received from the computer, and data is being sent to the computer. Refer to <a href="#">Chapter 4, Troubleshooting</a> , for more information.
③	RS-232 Serial Port	Locking low profile connector. The 1203-SFC serial cable is plugged into this connector.
④	1202-C10 Cable	SCANport/DPI cable (1 m) with male-to-male connectors.
⑤	1203-SFC Serial Cable	Serial cable (2 m) with a locking low profile connector to connect to the serial converter and a 9-pin sub-miniature D female connector to connect to a computer. <b>Tip:</b> This cable can also be used to make a serial connection to a 1203-CN1 ControlNet™ module or 1203-GU6 DeviceNet™ module.
Not Shown	DriveExplorer Lite CD-ROM	CD including DriveExplorer Lite software and documentation.

## Features

Features of the serial converter include the following:

- Three status indicators (LEDs) report the operating status of the module.
- Serial baud rates of 9600 bps, 19.2Kbps, and 38.4Kbps are supported. 9600 bps is the factory default.
- The serial converter can connect to products implementing SCANport such as 1336 PLUS II drives, or products implementing DPI such as PowerFlex drives. When used with a product, the serial converter will autobaud to the SCANport or DPI data rate that is used by the product.
- The serial converter receives power from the connection to the product. An outside power source is not needed.
- DriveExplorer (DPI products require version 2.01 or higher), DriveTools 2000 (version 1.xx or higher), or terminal emulation software can be used to configure a serial converter. In addition, a PowerFlex HIM can be used to configure a serial converter that is connected to a PowerFlex drive or other DPI product.

## Compatible Products

The serial converter can be used with Allen-Bradley products that implement SCANport or DPI.

SCANport products include the following:

Product	Product
1305 AC Drive (Drive firmware 2.01 or later)	1394 Motion System
1336 FORCE™ Drive	1397 DC Drive
1336 IMPACT™ Drive	1557 Medium Voltage Drive
1336 PLUS Drive	2364 Regenerative DC Bus Supply Unit
1336 PLUS II Drive	SMC Dialog Plus™
1336 REGEN Line Regeneration Package	SMP-3 Smart Motor Protector
1336 SPIDER Drive	

DPI products include the following:

Product	Product
PowerFlex 70 Drive	PowerFlex 7000 Drive
PowerFlex 700 Drive	

## Required Equipment

### Equipment Shipped with the Serial Converter

When you unpack the serial converter, verify that the package includes:

- One Smart Self-powered Serial converter
- One 1203-SFC serial cable
- One 1202-C10 cable
- One DriveExplorer Lite CD
- This manual

### User-Supplied Equipment

To configure the serial converter, you must use one of the following:

- DriveExplorer software  
DPI products require DriveExplorer version 2.01 or greater.  
SCANport products work with all versions of DriveExplorer.
- DriveTools 2000 software (version 1.xx or greater).
- PowerFlex HIM (only if using a PowerFlex drive or other DPI product).
- Terminal emulation software such as HyperTerminal.
- VT-100 compatible terminal.

## Safety Precautions

Please read the following safety precautions carefully.

---



**ATTENTION:** Risk of injury or equipment damage exists. Only personnel familiar with drive and power products and the associated machinery should plan or implement the installation, start-up, configuration, and subsequent maintenance of the product using a serial converter. Failure to comply may result in injury and/or equipment damage.



**ATTENTION:** Risk of injury or equipment damage exists. If the serial converter is transmitting control I/O to the product (indicated by a solid green diamond LED), the product may fault when you remove or reset the serial converter. Determine how your product will respond before removing or resetting a connected serial converter.



**ATTENTION:** Risk of injury or equipment damage exists. **Parameter 4 - [Comm Flt Action]** lets you determine the action of the serial converter and connected product if DF1 serial communications are disrupted. By default, this parameter faults the product. You can set this parameter so that the product continues to run. Precautions should be taken to ensure that the setting of this parameter does not create a hazard of injury or equipment damage.



**ATTENTION:** Risk of injury or equipment damage exists. DPI or SCANport host products must not be directly connected together via 1202 cables. Unpredictable behavior due to timing and other internal procedures can result if two or more devices are connected in this manner.

---

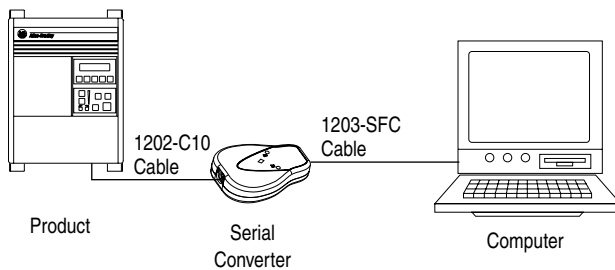
## Quick Start

This section is designed to help experienced users start using the serial converter. If you are unsure how to complete a step, refer to the referenced chapter.

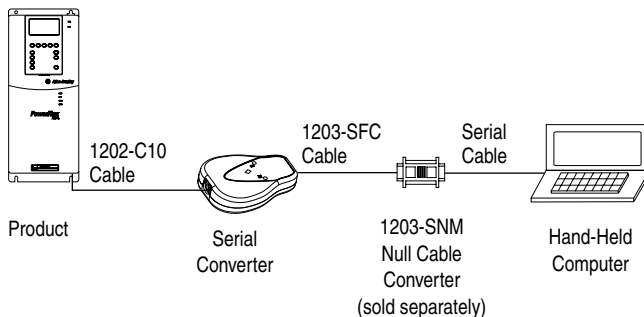
Step	Action	Refer to
1	<b>Review the safety precautions for the serial converter.</b>	Throughout This Manual
2	<b>Install the serial converter.</b> Connect a 1202-C10 cable to the serial converter and a compatible product. Then, connect a 1203-SFC serial cable to the serial converter and a computer. Make sure that power has been applied to the DPI or SCANport product.	<a href="#">Chapter 2, Installing the Serial Converter</a>
3	<b>Configure the serial converter parameters.</b> Use one of the following to configure parameters in the serial converter: <ul style="list-style-type: none"> <li>• DriveExplorer<sup>(1)</sup></li> <li>• DriveTools 2000 (v1.xx or greater)</li> <li>• PowerFlex HIM</li> <li>• Terminal emulation software</li> <li>• VT-100 compatible terminal</li> </ul>	<a href="#">Chapter 3, Configuring the Serial Converter</a>

(1) Products implementing DPI require version 2.01 or greater. Products implementing SCANport can use version 1.01 or greater.

**Figure 1.2 Example Serial Connection to a Computer**

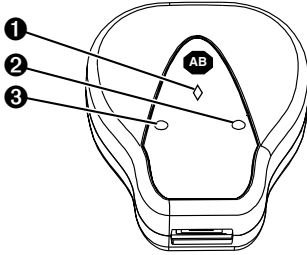


**Figure 1.3 Example Serial Connection to a Hand-Held Computer**



## Modes of Operation

Figure 1.4 Status Indicators on the Serial Converter



The serial converter reports its status using status indicators (Figure 1.4). The following table describes the state of the status indicators under normal operation:

#	Status Indicator	State	Description
❶	Diamond	Flashing Green	Serial converter is connected to a product implementing SCANport or DPI.
		Solid Green	Serial converter is or was receiving I/O. Removing or resetting the serial converter may cause a serial fault in the product. On DPI based products a "Soft Logout" can be performed allowing removal of the converter without a fault occurring.  <b>Tip:</b> To remove the adapter without faulting the drive, set the logic mask in the drive to ignore the adapter and then verify that the drive is receiving its Logic Command and Reference from another source.
		Off	No power or Flash operation in progress.
❷	TX	Off	Not transmitting data.
		Flashing Green	Transmitting data.
❸	RX	Off	Not receiving data.
		Flashing Green	Receiving data.

If the diamond status indicator is red, there is a problem. Refer to [Chapter 4, Troubleshooting](#).

## Installing the Serial Converter

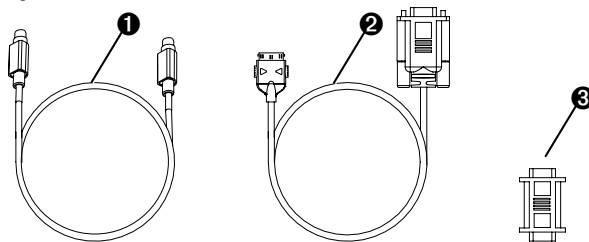
Chapter 2 provides instructions for installing and removing the serial converter.

Topic	Page
<a href="#">Selecting Cables</a>	<a href="#">2-1</a>
<a href="#">Installing the Serial Converter</a>	<a href="#">2-2</a>
<a href="#">Removing the Serial Converter</a>	<a href="#">2-2</a>

### Selecting Cables

The following cables are all you should need to connect the serial converter to a product and computer.

Figure 2.1 Cables



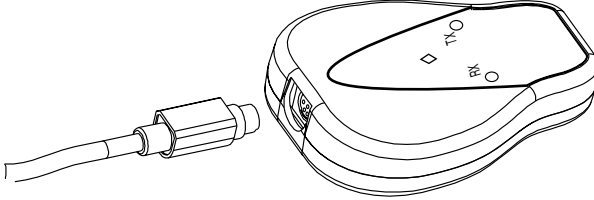
Number	Description	Catalog Number
❶	SCANport/DPI cable to connect the serial converter to a drive.	1202-C10
❷	Serial cable to connect the serial converter to the computer.	1203-SFC
❸	If you are connecting the serial converter to an H/PC (handheld PC), you must use a null modem cable with two male 9-pin sub-miniature D connectors. These must be purchased separately.	1203-SNM (sold separately)

**Important:** To provide proper termination of the serial cable shield, the chassis of the computer should be properly grounded. If it is not possible or practical to ground this, then a ground wire should be connected to the serial cable shield at the shell of the 9-pin sub-miniature D connector.

## Installing the Serial Converter

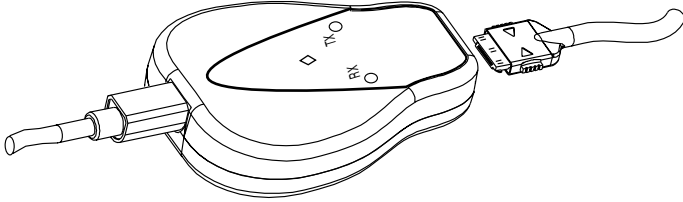
1. Connect the serial converter to the product using the 1202-C10 cable.

**Figure 2.2** Connecting a 1202-C10 Cable to the Serial Converter



2. Connect the converter to the computer using the 1203-SFC cable.

**Figure 2.3** Connecting a 1203-SFC Cable to the Serial Converter



3. Verify that power is applied to the product. The serial converter receives power from the product, so the product must be powered before the serial converter will operate.

The diamond light on the serial converter flashes green to indicate that the serial converter is properly installed and receiving power. If it is not green, refer to [Chapter 4, Troubleshooting](#).

## Removing the Serial Converter



**ATTENTION:** Risk of injury or equipment damage exists. If the serial converter is transmitting control I/O to the product (indicated by a solid green diamond LED), the product may fault when you remove or reset the serial converter. Determine how your product will respond before removing or resetting a connected serial converter.

---

1. Disconnect the 1202-C10 cable from the product and then from the converter. To disconnect it, gently push it in and then pull it out.
2. Disconnect the 1203-SFC serial cable from the serial converter and then the computer.



## Configuring the Serial Converter

Chapter 3 provides information about configuring the serial converter.

Topic	Page
<a href="#">Configuration Tools</a>	<a href="#">3-1</a>
<a href="#">Using the PowerFlex HIM</a>	<a href="#">3-2</a>
<a href="#">Using DriveExplorer</a>	<a href="#">3-3</a>
<a href="#">Using Terminal Emulation Software</a>	<a href="#">3-4</a>
<a href="#">Setting the Serial Port Rate</a>	<a href="#">3-8</a>
<a href="#">Setting the Fault Action</a>	<a href="#">3-9</a>
<a href="#">Resetting the Serial Converter</a>	<a href="#">3-10</a>

For a list of parameters, refer to [Appendix B, Serial Converter Parameters](#). For definitions of terms in this chapter, refer to the [Glossary](#).

### Configuration Tools

The serial converter stores parameters and other information in its own Non-Volatile Storage (NVS). You must, therefore, access the serial converter to view and edit its parameters. The following table lists tools that you can use to access the serial converter and edit its parameters.





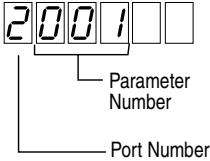

Tool	Refer To
DriveExplorer software <sup>(1)</sup>	page <a href="#">3-3</a> in this manual
DriveTools 2000 software (version 1.xx or greater)	Documentation for the software
PowerFlex HIM	page <a href="#">3-2</a> in this manual
Terminal emulation software	page <a href="#">3-4</a> in this manual
VT100-compatible terminal	Documentation for the terminal

<sup>(1)</sup> Products implementing DPI require version 2.01 or greater. Products implementing SCANport can use version 1.01 or greater.



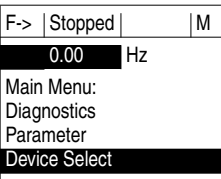




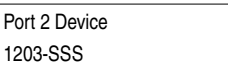
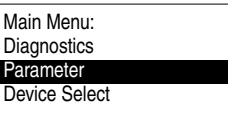
## Using the PowerFlex HIM

If you connect to a PowerFlex drive and it has either an LED or LCD HIM (Human Interface Module), you can use the HIM to access and edit parameters in the serial converter as shown below. It is recommended that you read through the steps for your HIM before performing the sequence. For additional HIM information, refer to your PowerFlex Drive User Manual or the HIM Quick Reference card.

### LED HIM Quick Start

Step	Key(s)	Example Screens
1. Press ALT and then Sel (Device) to display the Device Screen.	 	
2. Press the Up Arrow or Down Arrow to scroll to the serial converter. Letters represent files in the drive, and numbers represent ports. The converter is usually connected to port 2 (the external port) and sometimes to port 3 (available with a splitter).	 OR 	
3. Press the Enter key to enter your selection. A parameter database is constructed, and then the first parameter is displayed.		
4. Edit the parameters using the same techniques that you use to edit drive parameters.		

### LCD HIM Quick Start

Step	Key(s)	Example Screens
1. In the main menu, press the Up Arrow or Down Arrow to scroll to <b>Device Select</b> .	 OR 	
2. Press Enter to enter your selection.		
3. Press the Up Arrow or Down Arrow to scroll to <b>1203-SSS</b> .	 OR 	
4. Press Enter to select the serial converter. A parameter database is constructed, and then a menu for the serial converter is displayed.		
5. Edit the parameters using the same techniques that you use to edit drive parameters.		

## Using DriveExplorer

With DriveExplorer software, you can edit parameters in both the serial converter and the connected product. On a PowerFlex drive (or other DPI product), you can also edit parameters in any of the attached peripherals. DriveExplorer Lite is shipped with the serial converter. It is a free, limited-feature version of DriveExplorer.

### DriveExplorer Lite Quick Start

This section is designed to help users start using DriveExplorer Lite. If you are unsure how to complete a step, refer to the online help (select **Help > Help Topics**) or the *DriveExplorer Getting Results Manual*, Publication 9306-5.2, which is included on the CD.

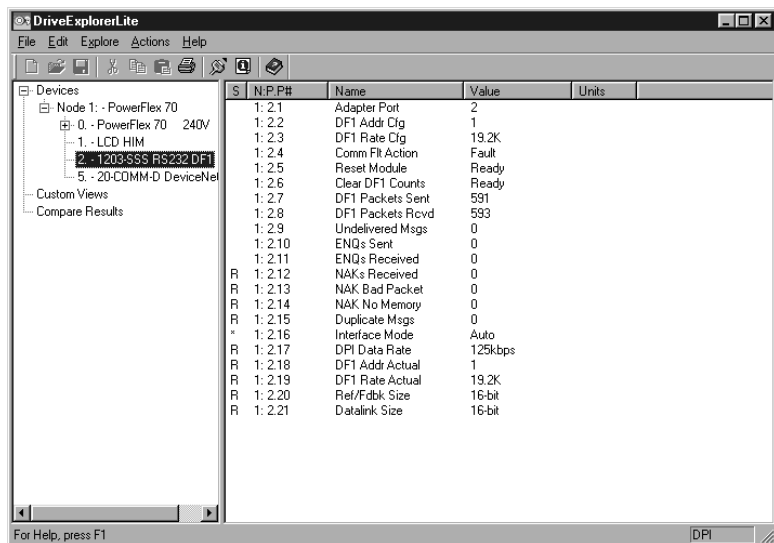
---

#### Step

---

- 1 Select **Explore > Configure Communication**. Select the communications port and baud rate that you are using. Select either checksum and accept the default time for the time-out.
  - 2 Select **Explore > Connect > Local**. A node eventually appears under Devices.
  - 3 In the left pane, click the + signs to expand the tree. Click the product or serial converter to display parameters in the right pane. Double-click a parameter to edit it.
- 

**Figure 3.1** DriveExplorer



## Using Terminal Emulation Software

This section provides detailed instructions on how to use terminal emulation software to access the serial converter so that you can view and edit serial converter parameters or view the serial converter event queue.

A variety of terminal emulation programs can be used to establish a serial connection between a computer and the serial converter. The following instructions describe how to establish the initial serial connection to the serial converter using a computer running HyperTerminal—terminal emulation software provided with most Windows operating systems.

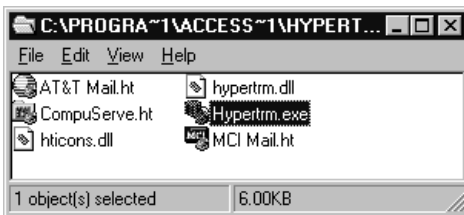
**Important:** The following instructions use screen captures from Windows 95 HyperTerminal. If you are using Windows NT™ or Windows 98 HyperTerminal, screens may differ.

### To use HyperTerminal to access the serial converter

1. Verify that the serial converter is installed correctly. Refer to [Chapter 2, Installing the Serial Converter](#).
2. On the Windows 95 desktop, click the **Start** button, and then select **Programs > Accessories > HyperTerminal** to display the HyperTerminal dialog box ([Figure 3.2](#)). Your dialog box may look slightly different.

On the Windows NT desktop, click the **Start** button, and then select **Programs > Accessories > HyperTerminal** to display the Connection dialog box (Refer to [Figure 3.3](#)). Then, go to step 6.

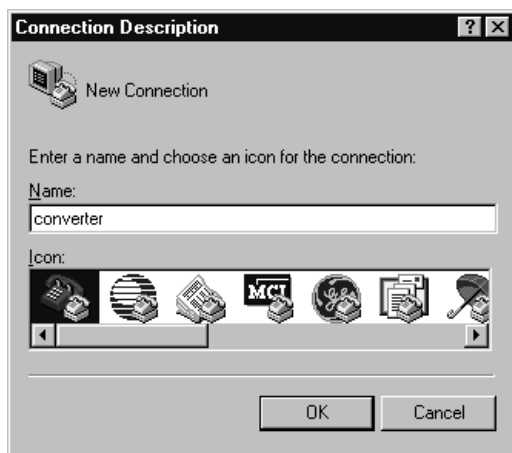
**Figure 3.2** HyperTerminal Dialog Box in List View



3. Double-click **Hypertrm.exe**.

The Connection Description dialog box appears in the HyperTerminal workspace.

**Figure 3.3** Connection Dialog Box

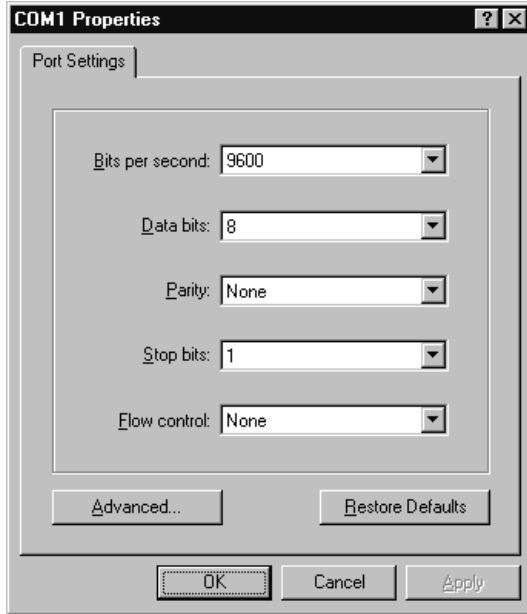


4. In the Name box, type any name (for example, converter), and then select any icon in the Icon box.
5. Click **OK** to display the Phone Number dialog box.
6. In the Connect Using box, select the communications port that you intend to use (usually COM1 or COM2).
7. Click **OK** to display the Properties dialog box.

8. Select the settings shown in [Figure 3.4](#).

**Important:** If you have previously set **Parameter 03 - [DF1 Rate Cfg]** to 19.2K or 38.4K, select that value in the Bits per second box.

Figure 3.4 Properties Dialog Box



9. Click **OK**. A blank HyperTerminal workspace appears.
10. Select **File > Properties** to display the Properties dialog box.
11. Click the **Settings** tab. See [Figure 3.5](#).
12. Under Function, arrow, and ctrl keys act as, select **Terminal keys**.
13. In the Emulation box, select **VT100**.

Figure 3.5 Properties Dialog Box



14. Click **OK** to display the HyperTerminal workspace.



**TIP:** Select **File > Save** to save the HyperTerminal configuration that you just created. In future connections, you can select the saved configuration and quickly connect to the serial converter.

15. Press the **Enter** key until the main menu appears.

Figure 3.6 Main Menu

```
Main Menu - Enter Number for Selection
1> Display Setup Parameters
2> Display Event Queue
3> Flash Upgrade
```

What do you want to do?	Page
Edit the serial port rate, or fault action	<a href="#">3-8</a> through <a href="#">3-10</a>
View the event queue	<a href="#">4-3</a>
View DF1 data	<a href="#">4-6</a>
Update the firmware	<a href="#">C-1</a>

If no text or meaningless text appears instead of the Main Menu, adjust the baud rate in your software. Refer to [Troubleshooting Potential Problems](#) in [Chapter 4](#) for detailed instructions.

### To navigate in the terminal emulation software

Key	Description
0 ... 9	In the main menu, keys 1 – 3 select a menu option. In the parameter screen, keys 0– 9 enter a value.
Esc	Display the main menu or abort changes to a parameter.
↑ OR ↓	Scroll through parameters or events.
→ OR ←	Scroll through the values for a parameter.
Enter	Save a value for a parameter.

### Setting the Serial Port Rate

The serial port rate, sometimes called baud rate or DF1 rate, is the speed at which the computer and serial converter communicate. You can select a serial port rate of 9600, 19.2K, or 38.4K with the serial converter (Series B). The factory-default serial port rate is 9600.

**Important:** If you change the serial port rate in the serial converter, you must set your software to use the same serial port rate.

#### To set the serial port rate

1. Set **Parameter 03 - [DF1 Rate Cfg]** to the desired rate.

**Figure 3.7 DF1 Rate Cfg Parameter in HyperTerminal**

Press the UP ARROW or DOWN ARROW key to scroll through the parameter list. Press the LEFT ARROW or RIGHT ARROW key to modify parameter values. Press the ENTER key to save a new value.

```
3> DF1 Rate Cfg = 9600
```

2. Reset the serial converter. Refer to [Resetting the Serial Converter](#) in this chapter.
3. Set the serial port rate in your software to match the new serial port rate in the serial converter.



## Setting the Fault Action

By default, when DF1 serial communications are disrupted (e.g., a serial cable is disconnected) and control I/O is being transmitted, the serial converter and connected product respond by faulting. You can set the following actions:

Action	Description
Fault	The product will fault.
Stop	The product will stop and not fault (DPI host products only).
Zero data	The product is sent 0 for output data after a communications disruption. This does not command a stop.
Hold last	The product continues in its present state after a communications disruption.



**ATTENTION:** Risk of injury or equipment damage exists.

**Parameter 04 - [Comm Flt Action]** lets you determine the action of the serial converter and connected product if communications are disrupted. By default, this parameter faults the product. You can set this parameter so that the product continues to run. Precautions should be taken to ensure that the setting of this parameter does not create a hazard of injury or equipment damage.

### To change the fault action

- Set the value of **Parameter 04 - [Comm Flt Action]** to the desired fault action.

**Figure 3.8 Comm Flt Action Parameter in HyperTerminal**

```
Press the UP ARROW or DOWN ARROW key to scroll
through the parameter list. Press the LEFT ARROW or
RIGHT ARROW key to modify parameter values. Press
the ENTER key to save a new value.
```

```
4> Comm Flt Action = Fault
```

Changes to this parameter take effect immediately. A reset is not required.

## Resetting the Serial Converter

After you change some parameters, you must reset the serial converter for the new setting to take effect. You can reset it by removing and then reapplying power or by using **Parameter 05 - [Reset Module]**.



**ATTENTION:** Risk of injury or equipment damage exists. If the serial converter is transmitting control I/O to the product (indicated by a solid green diamond LED), the product may fault when you remove or reset the serial converter. Determine how your product will respond before removing or resetting a connected serial converter.

---

### To reset the serial converter

- Set **Parameter 05 - [Reset Module]** to either **Reset Module** or **Set Defaults**. “Reset Module” will reset the serial converter. “Set Defaults” will set all parameters in the serial converter to their factory-default values.

**Figure 3.9 Reset Module Parameter in HyperTerminal**

```
Press the UP ARROW or DOWN ARROW key to scroll
through the parameter list. Press the LEFT ARROW or
RIGHT ARROW key to modify parameter values. Press
the ENTER key to save a new value.
```

```
5> Reset Module = Reset Module
```

After you enter the “Reset Module” value, the serial converter will be reset. This parameter will then be reset to “Ready.”

## Troubleshooting

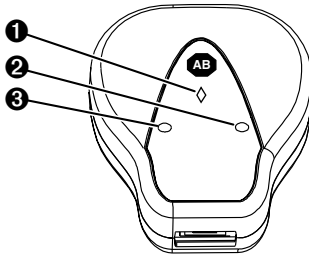
Chapter 4 provides information to troubleshoot the serial converter.

Topic	Page
<a href="#">Understanding the Status Indicators</a>	4-1
<a href="#">Module Diagnostic Items</a>	4-3
<a href="#">Viewing and Clearing the Event Queue</a>	4-3
<a href="#">Viewing and Clearing DF1 Communication Statistics</a>	4-6
<a href="#">Troubleshooting Potential Problems</a>	4-7

### Understanding the Status Indicators

The serial converter reports its status using status indicators. See [Figure 4.1](#).

**Figure 4.1** Status Indicators on the Serial Converter



#	Status Indicator	Description	Refer To
❶	Diamond	Serial converter status	<a href="#">Diamond Status Indicator</a> on page 4-2
❷	TX	Serial converter is transmitting data	<a href="#">TX Status Indicator</a> on page 4-2
❸	RX	Serial converter is receiving data	<a href="#">RX Status Indicator</a> on page 4-2

## Diamond Status Indicator



**ATTENTION:** Risk of injury or equipment damage exists. If the serial converter is transmitting control I/O to the product (indicated by a solid green diamond LED), the product may fault when you remove or reset the serial converter. Determine how your product will respond before removing or resetting a serial converter.

Status	Cause	Corrective Action
Off	Serial converter is not powered or in Flash programming mode.	<ul style="list-style-type: none"> <li>Securely connect cables.</li> <li>Apply power to the product.</li> <li>Wait while Flash is in progress.</li> </ul>
Flashing Green	Serial converter is operating and not transmitting control I/O.	<ul style="list-style-type: none"> <li>No Action. Removing or resetting the serial converter will not cause a serial fault in the product.</li> </ul>
Solid Green	Serial converter is operating and is or was transmitting control I/O.	<ul style="list-style-type: none"> <li>No Action. Removing or resetting the serial converter may cause a serial fault in the product. On DPI based products a "Soft Logout" can be performed allowing removal of the converter without a fault occurring. <b>Tip:</b> To remove the adapter without faulting the drive, set the logic mask in the drive to ignore the adapter and then verify that the drive is receiving its Logic Command and Reference from another source.</li> </ul>
Flashing Red	The product has not acknowledged the serial converter.	<ul style="list-style-type: none"> <li>Securely connect cables.</li> </ul>
Solid Red	Link Failure.	<ul style="list-style-type: none"> <li>Securely connect cables.</li> <li>Replace the cable.</li> <li>Cycle power to the product.</li> </ul>
Orange		<ul style="list-style-type: none"> <li>Contact Rockwell Automation Technical Support.</li> </ul>

## RX Status Indicator

Status	Cause	Corrective Action
Off	Serial converter is not receiving data.	<ul style="list-style-type: none"> <li>Verify that data is being transmitted.</li> <li>Securely connect cables.</li> <li>Apply power to the product.</li> </ul>
Flashing Green	Serial converter is receiving data from the computer.	<ul style="list-style-type: none"> <li>No action.</li> </ul>

## TX Status Indicator

Status	Cause	Corrective Action
Off	Serial converter is not transmitting data.	<ul style="list-style-type: none"> <li>Verify that data is being transmitted.</li> <li>Securely connect cables.</li> <li>Apply power to the product.</li> <li>Configure the computer software to use the same serial port rate as the serial converter.</li> </ul>
Flashing Green	Serial converter is transmitting data to the computer.	<ul style="list-style-type: none"> <li>No action.</li> </ul>

## Module Diagnostic Items

The following diagnostic items can be accessed using DriveExplorer (version 2.01 or higher).

No.	Name	Description
1	Common Logic Cmd	Current value of the Common Logic Command being transmitted to the host by this peripheral.
2	Prod Logic Cmd	Current value of the Product Specific Logic Command being transmitted to the host by this peripheral.
3	Reference	Current value of the Product Specific Reference being transmitted to the host by this peripheral.
4	Common Logic Sts	Current value of the Common Logic Status being received from the host by this peripheral.
5	Prod Logic Sts	Current value of the Product Specific Logic Status being received from the host by this peripheral.
6	Feedback	Current value of the Product Specific Feedback being received from the host by this peripheral.
7	DPI Rx Err Cntr	Current value of the DPI CAN Receive Error Counter register.
8	DPI Rx Err Max	Maximum value of the DPI CAN Receive Error Counter register.
9	DPI Tx Err Cntr	Current value of the DPI CAN Transmit Error Counter register.
10	DPI Tx Err Max	Maximum value of the DPI CAN Transmit Error Counter register.
11	Field Flash Cntr	Current value of the Field Flash Counter.
12	CPU	CPU Type.

## Viewing and Clearing the Event Queue

It is normal for the event queue in the serial converter to contain events. If you encounter unexpected communication problems, you can access the event queue and view the most recent events.

### To view the event queue

1. Access the event queue using a configuration tool. Refer to [Configuration Tools](#) in [Chapter 3](#).
2. Scroll through events in the event queue. The most recent event can be found at **2R > Event Queue 1**.

**Figure 4.2 Example Event Queue in HyperTerminal**

```
Press the UP ARROW or DOWN ARROW key to scroll
through the parameter list. Press the LEFT ARROW or
RIGHT ARROW key to modify parameter values. Press
the ENTER key to save a new value.
```

```
2R> Event Queue 1 = Pin ID Change
```

## Events

Many events in the Event queue occur under normal operation. If you encounter unexpected communications problems, the events may help you or Allen-Bradley personnel troubleshoot the problem. The following events may appear in the event queue:

**Table 4.A SCANport Mode**

Events	Description
Adapter Reset	The serial converter was reset or power cycled.
Clear SP Fault	The SCANport product issued this because a fault was cleared in it.
Clear SP Warning	The SCANport product issued this because a warning was cleared.
Empty Queue	No event is in the queue.
Message Timeout	The DPI product did not respond to a message request. Verify the cables are correct.
No SCANport Ping	The serial converter issued this because no SCANport pings were detected within a 2 second period. This event may be caused by a broken cable, a broken serial converter or a malfunction in the SCANport product.
Pin ID Change	The serial converter issued this because the SCANport Pin ID was changed. This event is normal after a power cycled or reset.
SCANport Bus Off	The serial converter issued this because its SCANport CAN chip went bus off. This event may be caused by loose or broken cables or by noise.
SCANport Fault	The SCANport product issued this because it was faulted. See its fault queue.
SCANport Reset	The SCANport product issued this because it was reset.
SCANport Warning	The SCANport product issued this because it had a warning.
SP Pin ID = 7	The serial converter issued this because its Pin ID has a value of 7. It should have a value between 1 and 6. This event may be caused by a loose or broken cable.

**Table 4.B DPI Mode**

Events	Description
Bad Host Flt	The serial converter was connected to an incompatible product.
Control Disabled	The serial converter has sent a "Soft Control Disable" command to the DPI product.
Control Enabled	The serial converter has sent a "Soft Control Enable" command to the DPI product.
DPI Bus Off Flt	A bus-off condition was detected on DPI. This event may be caused by loose or broken cables or by noise.
DPI Fault Clear	A DPI product has issued a fault clear message.
DPI Fault Msg	The drive entered a faulted state.
Dup. Port Flt	Another peripheral with the same port number is already in use.
EEPROM Sum Flt	The EEPROM in the serial converter is corrupt.
Host Sent Reset	The DPI product issued this because it was reset.
Message Timeout	The DPI product did not respond to a message request. Verify the cables are correct.
No Event	Empty event queue entry.
Normal Startup	Adapter initially powered up or was reset.
Online @ 125kbps	The serial converter and DPI product are communicating at 125kbps.
Online @ 500kbps	The serial converter and DPI product are communicating at 500kbps.
PCCC I/O Time Flt	The serial converter has not received a PCCC Control message for longer than the specified PCCC Control Time-out.
Ping in Message	An unexpected ping was received.
Ping Time Flt	A ping message was not received on DPI within the specified time.
Port Change Flt	The DPI port changed.
Port ID Flt	The serial converter is not connected to a correct port on a DPI product.
Type 0 Login	The serial converter has logged in for type 0 control.
Type 0 Time Flt	The serial converter has not received a type 0 status message within the specified time.
Use I/O Sent	The serial converter has begun sending product specific control information.

### To clear the event queue

1. Access the event queue using a configuration tool. Refer to [Configuration Tools](#) in [Chapter 3](#).
2. Set the value of **1 > Clr Event Queue** to **Enable**, and then press **Enter** to clear the event queue.

**Figure 4.3 Reset Event Queue in HyperTerminal**

Press the UP ARROW or DOWN ARROW key to scroll through the parameter list. Press the LEFT ARROW or RIGHT ARROW key to modify parameter values. Press the ENTER key to save a new value.

```
1> Clr Event Queue = Enable
```

## Viewing and Clearing DF1 Communication Statistics

If you encounter unexpected communications problems or are creating an application that uses DF1 data, you can view the communications statistics in the serial converter. Parameters 06 through 15 store this data.

In order to view and clear DF1 data, you must access the main menu in the serial converter firmware. Refer to [Configuration Tools](#) in [Chapter 3](#).

### To view DF1 data

1. Access the parameters in the serial converter using a configuration tool. Refer to [Configuration Tools](#) in [Chapter 3](#).
2. Scroll through the DF1 parameters. Parameters 06 through 15 contain DF1 data. For a description of each parameter, refer to [Appendix B, Serial Converter Parameters](#).

**Figure 4.4 Example Parameter Display in HyperTerminal**

```
Press the UP ARROW or DOWN ARROW key to scroll
through the parameter list. Press the LEFT ARROW or
RIGHT ARROW key to modify parameter values. Press
the ENTER key to save a new value.
```

```
7R> DF1 Packets Sent = 0
```

### To clear DF1 data

1. Access the parameters in the serial converter using a configuration tool. Refer to [Configuration Tools](#) in [Chapter 3](#).
2. Set the value of **Parameter 6 - [Clear DF1 Counts] to Clear Counts**, and then press **Enter** to clear the DF1 data.

**Figure 4.5 Example Parameter Display in HyperTerminal**

```
Press the UP ARROW or DOWN ARROW key to scroll
through the parameter list. Press the LEFT ARROW or
RIGHT ARROW key to modify parameter values. Press
the ENTER key to save a new value.
```

```
6> Clear DF1 Counts = Clear Counts
```



## Troubleshooting Potential Problems

Description	Action
<p>You are unable to establish a connection between your computer and the serial converter.</p>	<ul style="list-style-type: none"> <li>• If the status indicators are off, connect the cables and apply power to the product.</li> <li>• Configure your software and serial converter to use the same serial port rate (baud rate).</li> </ul>
<p>After changing the serial port rate, you are no longer able to communicate with the serial converter and connected product. For example, in HyperTerminal, meaningless text appears on the screen when you press Enter. In DriveExplorer, parameter values are not updated.</p>	<p>Reset the serial port rate in the software. Instructions are included here for resetting the serial port rate in HyperTerminal and DriveExplorer. If you are using a different configuration tool, refer to its user manual.</p> <p><b>HyperTerminal</b></p> <ol style="list-style-type: none"> <li>1. Select <b>File &gt; Properties</b>, and then click <b>Configure</b>.</li> <li>2. Select the new baud rate, and then click <b>OK</b>.</li> <li>3. Save and close HyperTerminal.</li> <li>4. Double-click on your HyperTerminal file (*.ht) to restart HyperTerminal.</li> <li>5. Press <b>Enter</b> until the main menu appears.</li> </ol> <p><b>DriveExplorer</b></p> <ol style="list-style-type: none"> <li>1. Select <b>Explore &gt; Configure Communication</b>.</li> <li>2. Select the new baud rate. DriveExplorer should start updating values again. If it does not, restart DriveExplorer.</li> </ol>
<p>You set a new serial port rate, but the serial converter is still using the old serial port rate.</p>	<ul style="list-style-type: none"> <li>• Reset the adapter. Refer to <a href="#">Chapter 3, Configuring the Serial Converter</a>.</li> </ul>
<p>You are using either DriveExplorer v1.xx or DriveTools32 v2.xx and you can not perform any of the following:</p> <ol style="list-style-type: none"> <li>1. Route out over a network, such as DeviceNet to another drive.</li> <li>2. Access DPI peripherals such as the 20-COMM-D DeviceNet adapter.</li> <li>3. Access 32-bit data.</li> </ol>	<p>Normal operation. These features require either:</p> <ul style="list-style-type: none"> <li>• DriveExplorer v2.xx or greater.</li> <li>• DriveTools 2000 v1.xx or greater.</li> </ul>
<p>You are using either DriveExplorer v2.xx (or greater) or DriveTools 2000 v1.xx (or greater) and you can not perform any of the following:</p> <ol style="list-style-type: none"> <li>1. Route out over a network, such as DeviceNet to another drive.</li> <li>2. Access DPI peripherals such as the 20-COMM-D DeviceNet adapter.</li> <li>3. Access 32-bit data.</li> </ol>	<ul style="list-style-type: none"> <li>• Check the 1203-SSS firmware version – you must have FRN 3.xxx or greater.</li> <li>• Parameter 16 - [Interface Select] must be set to "Auto."</li> <li>• Reset the converter. See <a href="#">Resetting the Serial Converter</a> in <a href="#">Chapter 3</a>.</li> </ul>

**Notes:**

## Specifications

Appendix A provides the specifications for the serial converter.

Topic	Page
<a href="#">Communications</a>	<a href="#">A-1</a>
<a href="#">Electrical</a>	<a href="#">A-1</a>
<a href="#">Mechanical</a>	<a href="#">A-1</a>

Topic	Page
<a href="#">Environmental</a>	<a href="#">A-2</a>
<a href="#">Regulatory Compliance</a>	<a href="#">A-2</a>

### Communications

Network	
Protocol	RS-232 Serial DF1, Full Duplex
Port Rate	9600, 19.2K, or 38.4K
Data Bits	8
Parity	None
Stop Bits	1
Flow Control	None
Error	CRC or BCC (Auto-Detected)
Product	
Protocol	SCANport: 125K
Data Rates	DPI: 125K/500K

### Electrical

Consumption	130mA at +12V DC The serial converter draws the required power from the connected product. An external power source is not required.
-------------	---

### Mechanical

Dimensions	103.5 x 73.4 x 23.6 mm (4.08 x 2.89 x 0.93 in.)
Weight	70.88 g (2.5 oz.)

## Environmental

Temperature	
Operating	0 to +50°C (32 to 122°F)
Storage	-40 to +85°C (-40 to 185°F)
Relative Humidity	5 to 95% non-condensing
Vibration	
Operating	2.5G @5Hz-2KHz
Non-Operating	5 G @5Hz-2KHz
Shock	
Operating	30 G peak acceleration, 11(+/-1)ms pulse width
Non-Operating	50 G peak acceleration, 11(+/-1)ms pulse width


## Regulatory Compliance


UL	508C and CUL
CE	

## Serial Converter Parameters

This chapter presents information about the parameters in the serial converter.

### Parameter List

No.	Name and Description	Details
01	<b>[Adapter Port]</b> Port on the host product to which the serial converter is connected.	Default: 0 Minimum: 0 Maximum: 7 Type: Read Only
02	<b>[DF1 Addr Cfg]</b> DF1 node address for the serial converter. This is a decimal value.	Default: 1 Minimum: 0 Maximum: 254 Type: Read/Write Reset Required: Yes
03	<b>[DF1 Rate Cfg]</b> Serial port rate for the DF1 serial port on the serial converter.	Default: 0 = 9600 Values: 0 = 9600 1 = 19.2K 2 = 38.4K Type: Read/Write Reset Required: Yes
04	<b>[Comm Flt Action]</b> Action that the serial converter and product take if the serial converter detects that DF1 serial communications are disrupted. This setting is effective only if control I/O is transmitted through the serial converter.	Default: 0 = Fault Values: 0 = Fault 1 = Stop (DPI) or Fault (SCANport) 2 = Zero Data 3 = Hold Last Type: Read/Write Reset Required: No
		 <p><b>ATTENTION:</b> Risk of injury or equipment damage exists. <b>Parameter 04 - [Comm Flt Action]</b> lets you determine the action of the serial converter and connected product if communications are disrupted. By default, this parameter faults the product. You can set this parameter so that the product continues to run. Precautions should be taken to ensure that the setting of this parameter does not create a hazard of injury or equipment damage.</p>

No.	Name and Description	Details
05	<p><b>[Reset Module]</b>                      Ready No action.                      Reset Module Resets the serial converter.                      Set Defaults Restores the serial converter to its factory-default settings.</p> <p>This parameter is a command. It will be set to "Ready" after a "Reset Module" command or "Set Defaults" command has been performed.</p>	<p>Default: 0 = Ready                      Values: 0 = Ready                      1 = Reset Module                      2 = Set Defaults                      Type: Read/Write</p>
<p> <b>ATTENTION:</b> Risk of injury or equipment damage exists. If the serial converter is transmitting control I/O to the product (indicated by a solid green diamond LED), the product may fault when you remove or reset the serial converter. Determine how your product will respond before removing or resetting a connected serial converter.</p>		
06	<p><b>[Clear DF1 Counts]</b>                      No action if set to "Ready." Resets the DF1 statistical parameters (numbers 07 – 15) to 0 if set to "Clear Counts." This parameter is a command. It will be reset to "0 = Ready" after a "Clear Counts" command has been performed.</p>	<p>Default: 0 = Ready                      Values: 0 = Ready                      1 = Clear Counts                      Type: Read/Write</p>
07	<p><b>[DF1 Packets Sent]</b>                      Number of DF1 packets sent by the serial converter. The value of this parameter is normally approximately equal to the value of Parameter 08 - [DF1 Packets Rcvd].</p>	<p>Default: 0                      Minimum: 0                      Maximum: 4294967295                      Type: Read Only</p>
08	<p><b>[DF1 Packets Rcvd]</b>                      Number of DF1 packets received by the serial converter. The value of this parameter is normally approximately equal to the value of Parameter 07 - [DF1 Packets Sent].</p>	<p>Default: 0                      Minimum: 0                      Maximum: 4294967295                      Type: Read Only</p>
09	<p><b>[Undelivered Msgs]<sup>(1)</sup></b>                      Number of DF1 messages that were sent but not acknowledged.</p>	<p>Default: 0                      Minimum: 0                      Maximum: 65535                      Type: Read Only</p>
10	<p><b>[ENQs Sent]<sup>(1)</sup></b>                      Number of ENQ characters sent by the serial converter.</p>	<p>Default: 0                      Minimum: 0                      Maximum: 65535                      Type: Read Only</p>
11	<p><b>[ENQs Received]<sup>(1)</sup></b>                      Number of ENQ characters received by the serial converter.</p>	<p>Default: 0                      Minimum: 0                      Maximum: 65535                      Type: Read Only</p>
12	<p><b>[NAKs Received]<sup>(1)</sup></b>                      Number of NAK characters received by the serial converter.</p>	<p>Default: 0                      Minimum: 0                      Maximum: 65535                      Type: Read Only</p>
13	<p><b>[NAK Bad Packet]<sup>(1)</sup></b>                      Number of NAKs sent by the serial converter because of corrupt packets (improper protocol messages) as determined by the serial converter.</p>	<p>Default: 0                      Minimum: 0                      Maximum: 65535                      Type: Read Only</p>

(1) This value is normally a low value. If it is continually incrementing and you are having communications problems, use a lower baud rate or replace the 1203-SFC serial cable.

No.	Name and Description	Details
14	<b>[NAK No Memory]<sup>(1)</sup></b> Number of NAKs sent by the serial converter because it did not have sufficient memory to buffer the incoming messages. The serial converter runs out of memory if a command has not completed and there is no place to save the new commands.	Default: 0 Minimum: 0 Maximum: 65535 Type: Read Only
15	<b>[Duplicate Msgs]<sup>(1)</sup></b> Number of duplicate messages sent by the serial converter. This value contains the total number of consecutive messages received by this device with the same TNS (Transaction Sequence) number.	Default: 0 Minimum: 0 Maximum: 65535 Type: Read Only
16	<b>[Interface Select]</b> Auto Converter will automatically run DPI if connected to a DPI product or SCANport if connected to a SCANport product.  SCANport Converter will perform SCANport services only.  Set this parameter to "Auto" (default) unless you are using DriveExplorer v1.xx or DriveTools32 v2.xx software and you are connected to a DPI product. Use "SCANport" for these software versions.	Default: 0 = Auto Values: 0 = Auto 1 = SCANport Type: Read/Write
17	<b>[DPI Data Rate]<sup>(2)</sup></b> Data rate used by the DPI host product. This data rate is set in the drive, and the adapter autobauds to it.	Default: 0 Values: 0 = 125 kbps 1 = 500 kbps Type: Read Only
18	<b>[DF1 Addr Actual]<sup>(2)</sup></b> DF1 address actually used by the serial converter.	Default: 1 Minimum: 0 Maximum: 254 Type: Read Only
19	<b>[DF1 Rate Actual]<sup>(2)</sup></b> Serial port rate actually used for the DF1 serial port on the serial converter.	Default: 0 = 9600 Values: 0 = 9600 1 = 19.2K 2 = 38.4K Type: Read Only
20	<b>[Ref/Fdbk Size]<sup>(2)</sup></b> Size of the Reference/Feedback. The host product determines the size of the Reference/Feedback. The serial converter automatically uses the correct size.	Default: 0 = 16-bit Value: 0 = 16-bit 1 = 32-bit Type: Read Only
21	<b>[Datalink Size]<sup>(2)</sup></b> Size of each Datalink word. The host product determines the size of Datalinks.	Default: 0 = 16-bit Values: 0 = 16-bit 1 = 32-bit Type: Read Only

(1) This value is normally a low value. If it is continually incrementing and you are having communications problems, use a lower baud rate or replace the 1203-SFC serial cable.

(2) The parameter appears only when the serial converter is connected to a product implementing DPI.

**Notes:**



## Flash Updates

Appendix C provides information on updating DPI host or peripheral product firmware.

Topic	Page
<a href="#">Preparing for a Flash Update</a>	C-1
<a href="#">Performing a Flash Update with HyperTerminal</a>	C-2
<a href="#">Troubleshooting Potential Flash Problems</a>	C-4

### Preparing for a Flash Update

Please take the following precautions to ensure a successful Flash:

- Obtain the new firmware version from Rockwell Automation. Save it to the hard drive of the computer. Do not attempt to perform a Flash from a floppy disk or a network.
- Read all instructions supplied with the new firmware file.
- Use a computer running terminal emulation software that supports Xmodem transfers (e.g., HyperTerminal). In this manual, we show how to use HyperTerminal.
- Record parameter values in the device that will be flashed. Updates may reset parameters to their default settings.
- Ensure that the DPI host product (i.e. PowerFlex 70) is stopped.
- Close all programs except the terminal emulation program that you are using to Flash the serial converter.
- Disable the screen saver and antivirus programs so that they do not start during the Flash.
- If you are using a laptop computer, turn off the FIFO buffers in HyperTerminal. In HyperTerminal, select **File > Properties** to display the Properties dialog box. Click **Configure**, and then click **Advanced**. Ensure that a check mark does not appear next to Use FIFO buffers.
- Verify that **Parameter 16 - [Interface Select]** is set to "Auto" (default).

## Performing a Flash Update with HyperTerminal

1. In the main menu ([Figure 3.6](#)), press **3** to Update Flash program.

If the serial converter is connected to a product implementing SCANport, you can only update the firmware in the serial converter. The screen in [Figure C.2](#) will immediately appear.

If the serial converter is connected to a product implementing DPI, a menu appears for you to select the device that you want to update.

**Figure C.1 Example DPI Flash Menu**

```
Flash Upgrade. Enter Number for Selection.
0 > PowerFlex 70
1 > LCD HIM
2 > This 1203-SSS
5 > 20-COMM-D
```

After you select a device by typing its number, a line appears to confirm that you selected the right device (for example, “You have chosen to update -- 2 > This 1203-SSS”) and the following text appears:

**Figure C.2 Flash Menu**

```
To update the Flash memory, you need a terminal
program capable of downloading a binary file using
the XMODEM protocol and a Flash update file from
Rockwell Automation. When you press 'Y' to signal
that you are ready to proceed, the terminal program
will start displaying the letter 'C'. This signals
the XMODEM protocol that the download may proceed.
You then have one minute to start the transfer.
Press CTRL-X to cancel an update started by
mistake. Are you ready to proceed? (Y/N)
```



**ATTENTION:** Hazard of injury or equipment damage exists. When you perform a Flash update, the product will fault if it is receiving control I/O from the serial converter. Verify that the product has stopped safely or is receiving control I/O from an alternate source before beginning a Flash update.



**ATTENTION:** Hazard of equipment damage exists. If you interrupt a flash procedure that is updating boot code, the device may become inoperable. To prevent this damage, follow the instructions provided with the new firmware file and do not interrupt a flash procedure while boot code is being flashed.

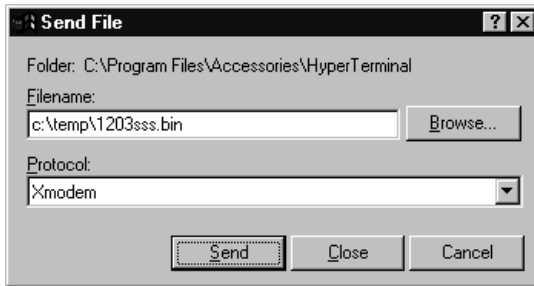
---

2. If the Flash can be completed safely, type **Y**. The letter “C” repeatedly appears. It is the Xmodem prompt and continues to appear until you send a binary file.

**Important:** Press Ctrl + X to cancel a Flash update procedure.

3. Select **Transfer > Send File** to display the send file dialog box.
4. Click **Browse** and navigate to the Flash file.
5. Double-click the file. Its name appears in the Filename box.
6. In the Protocol box, select Xmodem.

**Figure 4.6** Example Send File Dialog Box



7. Click **Send**. A dialog box appears and reports the progress of the download. When it is complete, the message “Operation Complete” appears.

**Important:** Keep the device powered for 15 seconds after the operation has completed.

8. Press the Enter key to return to the main menu.

## Troubleshooting Potential Flash Problems

Description	Corrective Action
<p>"Transfer Cancelled by Remote System" message appears and the Flash is not completed.</p>	<ul style="list-style-type: none"> <li>• Restart HyperTerminal and repeat the Flash procedure.</li> <li>• If you are using Windows NT 4.0, install SP3 or later. Windows NT service packs are available from the Microsoft web site: <a href="http://www.microsoft.com">http://www.microsoft.com</a>.</li> <li>• Download a HyperTerminal Private Edition update from the Hilgraeve web site: <a href="http://www.hilgraeve.com">http://www.hilgraeve.com</a>. (Please note that there is a license requirement with this software.) Then, perform the Flash procedure again.</li> </ul>
<p>The "Xmodem File Send" for dialog box appears, but the Flash file is not transferred.</p>	<ul style="list-style-type: none"> <li>• Verify that you have selected the Xmodem protocol in the Send file dialog box.</li> <li>• Verify that the new file is on your hard disk. Do not attempt to Flash from a floppy disk or a network.</li> <li>• Verify that you are sending the file within 60 seconds of pressing Y to confirm that you want to perform the Flash.</li> </ul>
<p>After completing a Flash, you are unable to communicate with the serial converter. For example, meaningless text appears on the HyperTerminal screen.</p>	<ul style="list-style-type: none"> <li>• Set the serial port rate to 9600. If parameters are changed during a Flash update, all parameters are set to their default settings.</li> </ul>
<p>You are unable to initiate a Flash to a DPL host or peripheral product.</p>	<ul style="list-style-type: none"> <li>• Verify that Parameter 16 - [Interface Select] is set to "Auto" (default setting).</li> </ul>

## **A**    **Application Code**

Code that runs in the adapter after the boot code calls it. It performs the normal operations of the system.

## **B**    **BCC**

Block Check Character. An error detection scheme where the 2's complement of the 8-bit sum (modulo-256 arithmetic sum) of all data bytes in a transmission block. It provides a means of checking the accuracy of each message transmission.

### **Boot Code**

Code that runs when the adapter first receives power. It checks basic operations and then calls the application code.

### **Bus Off**

A bus off condition occurs when an abnormal rate of errors is detected on the Control Area Network (CAN) bus in a device. The bus-off device cannot receive or transmit messages. This condition is often caused by corruption of the network data signals due to noise or data rate mismatch.

## **C**    **CRC**

Cyclic redundancy check. An error detection scheme where all of the characters in a message are treated as a string of bits representing a binary number. This number is divided by a predetermined binary number (a polynomial) and the remainder is appended to the message as a CRC character. A similar operation occurs at the receiving end to prove transmission integrity.

## **D**    **DF1 Protocol**

A peer-to-peer link layer protocol that combines features of ANSI X3.28-1976 specification subcategories D1 (data transparency) and F1 (two-way simultaneous transmission with embedded responses).

### **DF1 Rate**

A unit of signaling speed equal to the number of discrete conditions or signal events per second. It is also called "baud rate" or "serial port rate."

### **DPI**

DPI is a second generation peripheral communication interface used by various Allen-Bradley drives and power products. It is a functional enhancement to SCANport.

### **DPI Peripheral**

A device that provides an interface between DPI and a network or user. Peripheral devices are also referred to as “adapters” and “modules.” The serial converter and PowerFlex HIM are examples of DPI peripherals.

### **DPI Product**

A device that uses the DPI communications interface to communicate with one or more peripheral devices. For example, a motor drive such as a PowerFlex drive is a DPI product. In this manual, a DPI product is also referred to as “product” or “host.”

### **DriveExplorer**

An easy-to-use software application designed for Microsoft Windows 95, Windows 98, Windows NT (4.0 or greater), and Windows CE (2.0 or greater) operating systems. To fully utilize DPI products, use DriveExplorer version 2.xx or greater. SCANport products work with all versions of DriveExplorer. This application is a tool for monitoring and configuring Allen-Bradley products and adapters. A free version of DriveExplorer Lite is included with the serial converter. Information about DriveExplorer can be accessed at <http://www.ab.com/drives/driveexplorer>.

### **DriveTools**

A software suite designed for Microsoft Windows 95, Windows 98, and Windows NT (4.0 or greater) operating systems. To fully utilize DPI products, use DriveTools 2000 version 1.xx or greater. SCANport products work with all versions of DriveTools32 (or DriveTools 2000). This software suite provides a family of tools that you can use to program, monitor, control, troubleshoot, and maintain Allen-Bradley products. Information about DriveTools can be accessed at <http://www.ab.com/drives>.

## **F Flash Update**

The process of updating firmware in a device.

**H HIM (Human Interface Module)**

A device that can be used to configure and control a PowerFlex drive. New HIMs (20-HIM-x) can be used to configure connected peripherals such as the serial converter.

**Hold Last**

When communications are disrupted (e.g., serial cable is disconnected), the converter and product can respond by holding last state. Hold last state results in the product receiving the last data received via the DFI connection before the disruption. If the product was in RUN mode and using the Reference from the converter, it will continue to run at the same Reference.

**N Non-Volatile Storage (NVS)**

NVS is the permanent memory of a device. Devices such as the converter store parameters and other information in NVS so that they are not lost when the device loses power. NVS is sometimes called “EEPROM.”

**P PCCC (Programmable Controller Communications Command)**

PCCC is the protocol used by some controllers to communicate with devices on a network. Some software products (for example, DriveExplorer and DriveTools 2000) also use PCCC to communicate.

**Ping**

A ping is a message that is sent by a DPI product to its peripheral devices. They use the ping to gather data about the product, including whether it can receive messages and whether they can log in for control.

**S SCANport**

A peripheral communications interface for various Allen-Bradley drives and power products.

**SCANport Peripheral Device**

A device that provides an interface between SCANport and a network or user. Peripheral devices are also referred to as “adapters” and “modules.” The serial converter and HIM are examples of SCANport peripherals.

**SCANport Product**

A device that uses the SCANport communications interface to communicate with one or more peripheral devices. For example, a motor drive such as a 1336 PLUS II is a SCANport product. In this manual, a SCANport product is also referred to as “product.”

**Serial Converter**

The serial converter provides an electronic communications interface between any Allen-Bradley SCANport/DPI product and a computer with an RS-232 port. This converter uses a full-duplex RS-232 DF1 protocol. The serial converter may also be referred to as “1203-SSS converter,” “converter,” “DPI peripheral,” or “SCANport peripheral.”

**Status Indicators**

Status indicators are LEDs that are used to report the status of a device. There are three status indicators on the converter.

**T Type 0/Type 1/Type 2 Control**

When transmitting I/O, the adapter can use different types of messages for control. The Type 0, Type 1, and Type 2 events help Allen-Bradley personnel identify the type of messages that an adapter is using.

**X Xmodem**

Developed by Ward Christensen in 1978, Xmodem is a protocol used to transfer data. You can use the Xmodem protocol to flash the firmware in the serial converter or a device connected to it.

**Z Zero Data**

When communications are disrupted (e.g., serial cable is disconnected), the converter and product can respond with zero data. Zero data results in the product receiving zero as values for command data. If the product was in RUN mode and using the Reference from the converter, it will stay in run mode but at zero Reference.



**Notes:**

**Notes:**

**Notes:**

Notes:

**Notes:**

**Notes:**

## Numerics

1203-SSS converter, see serial converter

## A

accessing parameters, **3-1**  
Adapter Port parameter, **B-1**  
adapter, see serial converter  
application code, **G-1**  
attentions, **1-4**

## B

baud rate, refer to DF1 rate  
BCC, **A-1, G-1**  
boot code, **G-1**  
bus off, **G-1**

## C

cables  
connecting, **2-2**  
disconnecting, **2-2**  
selecting, **2-1**  
catalog numbers, **1-1**  
checksum, **A-1**  
Clear DF1 Counts parameter, **B-2**  
clearing DF1 data, **4-6**  
clearing events, **4-5**  
Comm Fit Action parameter, **B-1**  
communications specifications, **A-1**  
compatible products, **1-2**  
components, **1-1**  
converter, see serial converter  
CRC, **A-1, G-1**

## D

data bits, **A-1**  
Datalink Size parameter, **B-3**  
DF1  
definition, **G-1**  
viewing data, **4-6**  
DF1 Addr Actual parameter, **B-3**  
DF1 Addr Cfg parameter, **B-1**  
DF1 Packets Rcvd parameter, **B-2**  
DF1 Packets Sent parameter, **B-2**  
DF1 rate  
definition, **G-1**  
setting, **3-8**  
specification, **A-1**  
DF1 Rate Actual parameter, **B-3**  
DF1 Rate Cfg parameter, **B-1**  
Diamond status indicator, **4-2**  
dimensions, **A-1**  
DPI  
cables, **2-1, 2-2**  
definition, **G-2**  
peripheral, **G-2**  
products, **1-2, G-2**  
DPI Data Rate parameter, **B-3**  
DriveExplorer  
definition, **G-2**  
documentation, **P-1**  
free lite version, **G-2**  
using, **3-3**  
drives, see SCANport or DPI products  
DriveTools  
definition, **G-2**  
documentation, **P-1**  
Duplicate Msgs parameter, **B-3**

## E

- EEPROM, refer to Non-Volatile Storage (NVS)
- ENQs Received parameter, **B-2**
- ENQs Sent parameter, **B-2**
- equipment
  - required, **1-3**
  - supplied, **1-3**
- error detection, **A-1**
- event queue
  - clearing events, **4-5**
  - list of events, **4-4**
  - viewing events, **4-3**
- events
  - clearing, **4-3**
  - viewing, **4-3**

## F

- fault action, **3-9**
- fault queue, refer to event queue
- faults, refer to events
- firmware
  - parameters in, **3-1**
  - release, **P-1**
  - updating, **C-1**
- Flash update
  - definition, **G-2**
  - instructions, **C-1**
  - troubleshooting, **C-4**
- flow control, **A-1**
- FRN, **P-1**

## H

- Handheld PC, **2-1**
- HIM (Human Interface Module)
  - definition, **G-3**
  - using, **3-2**

- hold last
  - definition, **G-3**
  - setting, **3-9**

## HPC, **2-1**

- HyperTerminal
  - navigating in, **3-8**
  - setting up, **3-4**
  - updating firmware with, **C-4**

## I

- installing a serial converter, **2-2**
- Interface Select parameter, **B-3**

## K

- keys, **3-8**

## L

- LCD HIM, **3-2**
- LED HIM, **3-2**
- LEDs, refer to status indicators

## M

- main menu, **3-7**
- manual conventions, **P-1**
- mechanical specifications, **A-1**

## N

- NAK Bad Packet parameter, **B-2**
- NAK No Memory parameter, **B-3**
- NAKs Received parameter, **B-2**
- navigating in the firmware, **3-8**
- Non-Volatile Storage (NVS)
  - definition, **G-3**
  - parameters in, **3-1**



**P**

parameters  
  accessing, **3-1**  
  list of, **B-1–B-3**  
  manual conventions, **P-1**  
parity, **A-1**  
PCCC, **G-3**  
ping, **G-3**  
power consumption, **A-1**  
power cycle, **3-10**  
products, see SCANport or DPI products  
protocol, **A-1**

**Q**

quick start, **1-5**

**R**

Ref/Fdbck Size parameter, **B-3**  
regulatory compliance, **A-2**  
related documentation, **P-1**  
removing a serial converter, **2-2**  
Reset Module parameter, **B-2**  
resetting the converter, **3-10**  
RX status indicator, **4-2**

**S**

safety precautions, **1-4**  
SCANport  
  cables, **2-1, 2-2**  
  definition, **G-3**  
  peripheral, **G-3**  
  products, **1-2, G-4**  
  serial cables, **2-1, 2-2**

serial converter  
  accessing, **3-1**  
  components, **1-1**  
  definition, **G-4**  
  event queue, **4-3**  
  features, **1-2**  
  illustration, **1-1**  
  installing, **2-2**  
  parameters, **B-1–B-3**  
  removing, **2-2**  
  resetting, **3-10**

serial port rate, refer to DF1 rate  
Soft Logout, **1-6, 4-2**  
specifications, **A-1**  
status indicators  
  definition, **G-4**  
  operating status, **4-1**  
  troubleshooting with, **4-2**  
stop bits, **A-1**

**T**

technical support, **P-2**  
terminal emulation software, **3-1, 3-4**  
tools, see equipment  
troubleshooting, **4-1**  
TX status indicator, **4-2**

**U**

Undelivered Msgs parameter, **B-2**  
update, see Flash update

**V**

viewing DF1 data, **4-6**  
VT100-compatible terminal, **3-1**

**W**

web sites, **P-1, G-2**

## X

Xmodem

definition, **G-4**

using to flash firmware, **C-1**

## Z

zero data

definition, **G-4**

setting, **3-9**

1336 FORCE, 1336 IMPACT, Allen-Bradley, DPI, DriveExplorer, DriveTools 2000, DriveTools32, PowerFlex, SCANport, and SMC Dialog Plus are trademarks of Rockwell Automation.

DeviceNet is a trademark of the Open DeviceNet Vendor Association.

ControlNet is a trademark of ControlNet International Ltd.

Windows, Windows CE, Windows NT, and Microsoft are either registered trademarks or trademarks of Microsoft Corporation.

---

**Reach us now at [www.rockwellautomation.com](http://www.rockwellautomation.com)**

Wherever you need us, Rockwell Automation brings together leading brands in industrial automation including Allen-Bradley controls, Reliance Electric power transmission products, Dodge mechanical power transmission components, and Rockwell Software. Rockwell Automation's unique, flexible approach to helping customers achieve a competitive advantage is supported by thousands of authorized partners, distributors and system integrators around the world.

**Americas Headquarters**, 1201 South Second Street, Milwaukee, WI 53201-2496, USA, Tel: (1) 414 382-2000, Fax: (1) 414 382-4444  
**European Headquarters SANV**, Boulevard du Souverain 36, 1170 Brussels, Belgium, Tel: (32) 2 663 0600, Fax: (32) 2 663 0640  
**Asia Pacific Headquarters**, 27/F Citicorp Centre, 18 Whitfield Road, Causeway Bay, Hong Kong, Tel: (852) 2887 4788, Fax: (852) 2508 1846



**Rockwell  
Automation**