

1756-IA16, TC-IDA161

1492-IFM20D120N

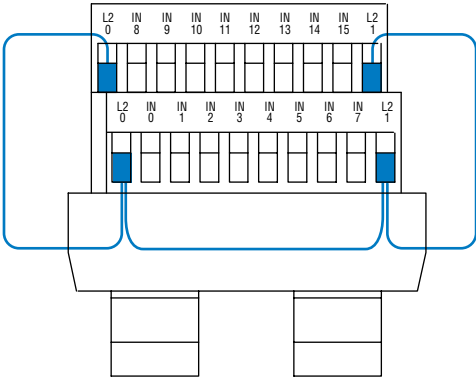

① Cables are available in 0.5m, 1.0m, 2.5m and 5.0m standard lengths (005=0.5m, 010=1.0m, 025=2.5m, 050=5.0m). Custom length cables are also available.

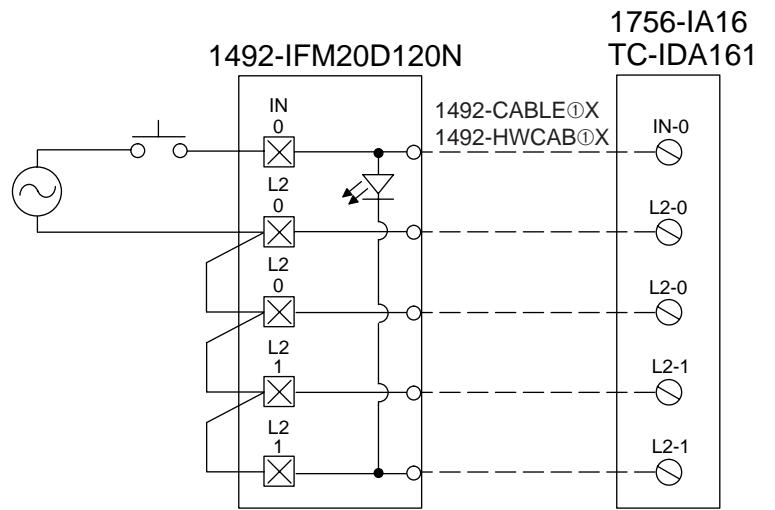

1492 Wiring Diagram Symbology Reference List

 = Required Fieldside Jumper (solid jumper)

 = Optional Fieldside Jumper [Refer to Application Footnotes.] (dashed jumper)

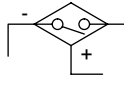
 = Three-wire Sinking Input Device

 = Three-wire Sourcing Input Device

 = AC Supply

 = DC Supply

 = Input Device

 = Output Device

 = Fuse with Blown Fuse Indicator

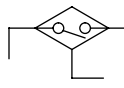
 = Three-wire AC Input Device

 = Fieldside Terminal

 = I/O Module Connection

 = LED Indicator

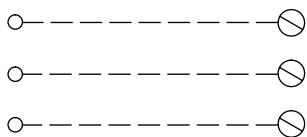
 = 1492 Pre-wired Cable

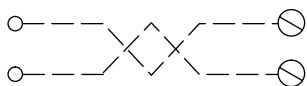
 = 1492 Pre-wired Shielded Cable

Note: Labels for SLC all shown in decimal - octal also available.