

# E3 Plus EtherNet/IP Adapter

Catalog Number 2100-ENET

Topic	Page
Introduction	1
Important User Information	2
Adapter Components	3
Status Indicators	4
Set the IP Network Address	4
Install EDS File	7
Logix Controller I/O Messaging	9
Additional Resources	12

## Introduction

The E3 Plus EtherNet/IP adapter is a linking device that lets users connect an E3 or E3 Plus Solid State Overload or an 825-P Motor Protection System directly to an EtherNet/IP network. This document explains the basic steps needed to configure the E3 Plus EtherNet/IP adapter.

## Important User Information

Solid-state equipment has operational characteristics differing from those of electromechanical equipment. Safety Guidelines for the Application, Installation and Maintenance of Solid State Controls (Publication [SGI-1.1](#) available from your local Rockwell Automation sales office or online at <http://www.rockwellautomation.com/literature/>) describes some important differences between solid-state equipment and hard-wired electromechanical devices. Because of this difference, and also because of the wide variety of uses for solid-state equipment, all persons responsible for applying this equipment must satisfy themselves that each intended application of this equipment is acceptable.

In no event will Rockwell Automation, Inc. be responsible or liable for indirect or consequential damages resulting from the use or application of this equipment.

The examples and diagrams in this manual are included solely for illustrative purposes. Because of the many variables and requirements associated with any particular installation, Rockwell Automation, Inc. cannot assume responsibility or liability for actual use based on the examples and diagrams.

No patent liability is assumed by Rockwell Automation, Inc. with respect to use of information, circuits, equipment, or software described in this manual.

Reproduction of the contents of this manual, in whole or in part, without written permission of Rockwell Automation, Inc., is prohibited.

Throughout this manual, when necessary, we use notes to make you aware of safety considerations.

---



**WARNING:** Identifies information about practices or circumstances that can cause an explosion in a hazardous environment, which may lead to personal injury or death, property damage, or economic loss.

---



**ATTENTION:** Identifies information about practices or circumstances that can lead to personal injury or death, property damage, or economic loss. Attentions help you identify a hazard, avoid a hazard and recognize the consequences.

---



**SHOCK HAZARD:** Labels may be on or inside the equipment, for example, drive or motor, to alert people that dangerous voltage may be present.

---



**BURN HAZARD:** Labels may be on or inside the equipment, for example, drive or motor, to alert people that surfaces may reach dangerous temperatures.

---

**IMPORTANT**

Identifies information that is critical for successful application and understanding of the product.

---

## Adapter Components

The adapter has these components.

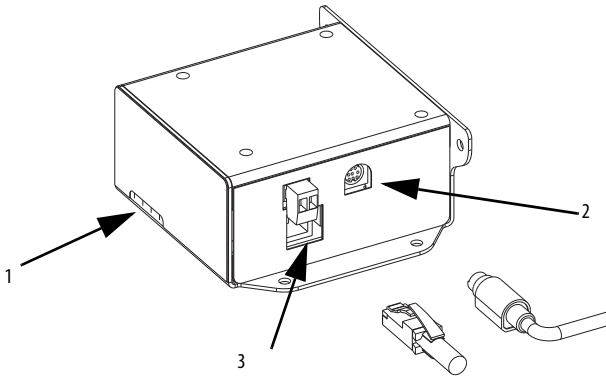

Item	Part	Description
1	Status Indicators	Four status indicators for the DeviceNet, adapter, and network connection.
2	E3 Connector	This connector is provided for the connection to the E3 Plus or the 825-P.
3	Ethernet Connector	An RJ-45 connector for the Ethernet cable. The connector is CAT-5 compliant to ensure reliable data transfer on 100Base-TX Ethernet connections.

The E3+ and 825-P must be set to node 63 and have a communication rate of 500K (or have the autobaud enabled). This is the default state of each of these devices.

## Status Indicators

The adapter uses four status indicators to report its operating status.

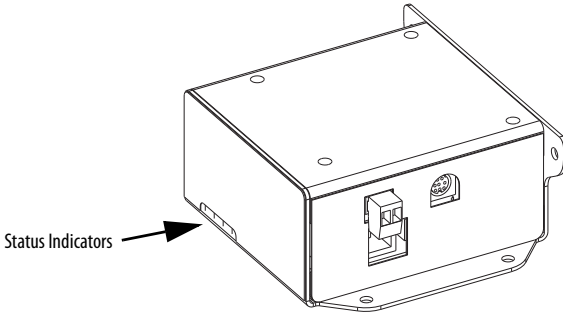

Item	Name	Color	State	Description
1	PORT	Green	Flashing	Normal Operation. The adapter is establishing an I/O connection to the E3 Plus overload relay. It will turn steady green or red.
2	MOD		Steady	Normal Operation. The adapter is properly connected and communicating with the E3 Plus overload relay.
3	NET A	Green	Flashing	Normal Operation. The adapter is operating but is not transferring I/O data to a controller.
4	NET B		Steady	Normal Operation. The adapter is operating and transferring I/O data to a controller.

## Set the IP Network Address

The E3 Plus EtherNet/IP adapter is shipped with Bootstrap Protocol (BOOTP) enabled. You can set the network Internet Protocol (IP) address by using the BOOTP/DHCP server that is provided with RSLinx Classic software. This utility recognizes BOOTP-enabled devices and provides an interface to configure a static IP address for each device.

To assign network parameters via the BOOTP/DHCP utility, perform this procedure.

1. Start the BOOTP/DHCP software.

2. Select Tool > Network Settings and enter the subnet mask for the network.

If appropriate for the network, enter the gateway address, primary/secondary server addresses, and domain name.

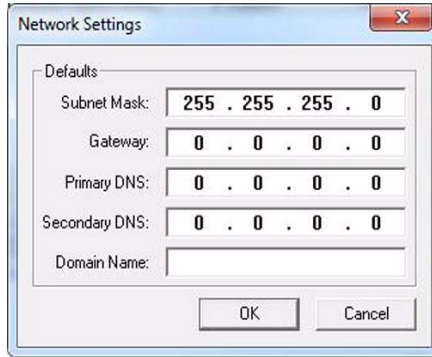

3. Click OK.

The Request History panel displays the hardware addresses of devices issuing BOOTP or DHCP requests.

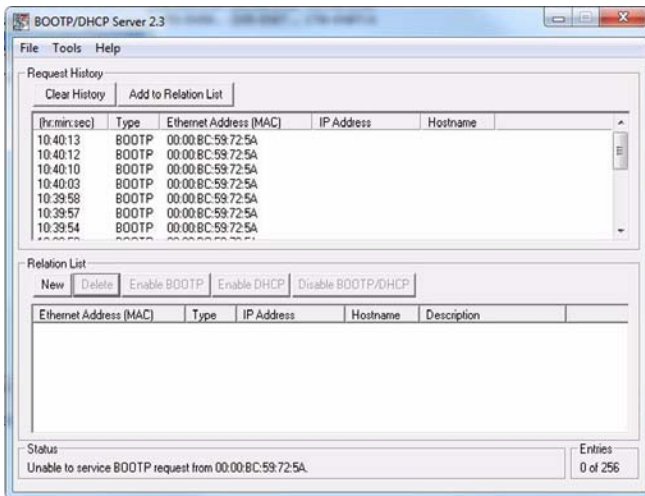

4. Double-click the MAC address of the adapter to be configured.

The MAC address is printed on the side of the E3 Plus EtherNet/IP adapter. The format of the hardware address resembles 00:00:BC:59:72:5A. The New Entry dialog box appears with the module's Ethernet Address (MAC).

5. Enter the IP address for the adapter and, if appropriate, enter the host name and an adapter description.

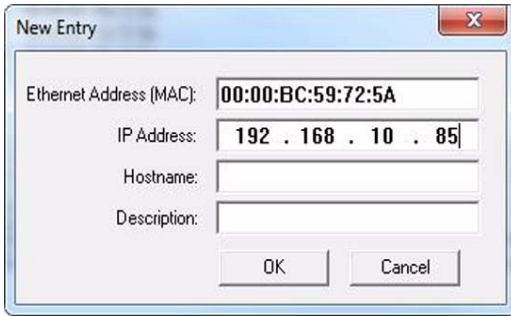

6. Click OK.

Once the IP address you entered shows up in the Request History panel (you may need to cycle power to the adapter), this configuration can be permanently assigned to the adapter.

7. To do so, highlight the adapter in the Relation List panel and click Disable BOOTP/DHCP.
8. Confirm that the Status panel message reads, '[Disable BOOTP] Command successful'.

When the adapter power is recycled, it will use the assigned configuration and will not issue a BOOTP request. If you do not click Disable BOOTP/DHCP, the adapter clears the current IP configuration after a power cycle and will again begin sending BOOTP requests.

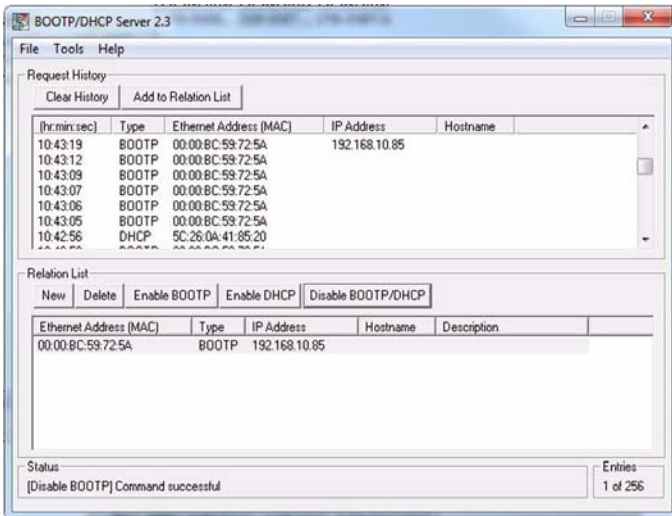

## Install EDS File

Before the E3 Plus EtherNet/IP adapter is configured to communicate on an EtherNet/IP network, it must be registered to the software that configures the network, for example, RSLinx Classic software. You can register the adapter by installing an electronic data sheet (EDS file). For the E3 Plus EtherNet/IP adapter, you will install an EDS file for the device that is connected to the adapter. Use the following procedure to download and register the EDS file for the E3 Plus EtherNet/IP adapter.

### Download EDS file from the EDS Website

The EDS file for the device connected to the E3 Plus EtherNet/IP adapter can be found at <http://www.rockwellautomation.com/resources/eds/>.

1. When the web page for the link above comes up, enter the following information.

	<b>E3 Plus Overload</b>	<b>825-P</b>
Network	EtherNet/IP	EtherNet/IP
Device Type	Motor Protector	Motor Protector
Bulletin/Catalog No.	2100-ENET	2100-ENET
Major Revision	(Leave Blank)	(Leave Blank)
Minor Revision	(Leave Blank)	(Leave Blank)
Keyword	(Leave Blank)	(Leave Blank)

2. Select the file that relates to the E3 or 825-P module that is connected to the 2100-ENET unit.
3. In the Details & Download column for the device, select Download.
4. Click Save to save the EDS file to your personal computer.

### Register the EDS File

After the EDS file has been downloaded, you need to register the EDS file with the software that configures the EtherNet/IP network. Follow these steps to register an EDS file with RSLinx Classic software.

1. Start the EDS Hardware Installation Tool at Start->Programs->Rockwell Software->RSLinx->Tools.
2. Click Add to register a new device.

3. Register a single file, browse to the location of the EDS file, and click Next.

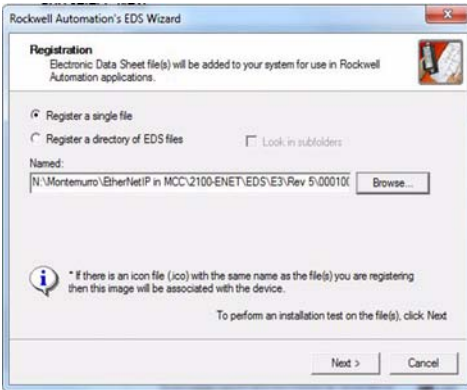

4. Click Next to accept the installation test results.

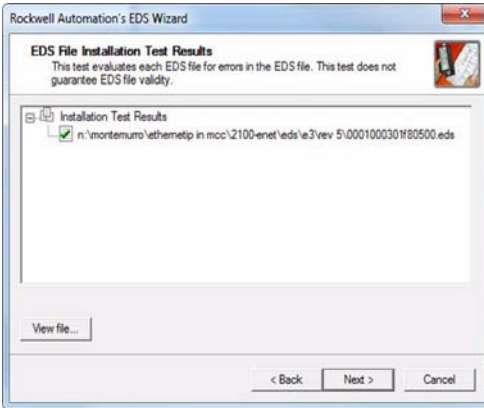

5. Click Next to accept the graphic image.

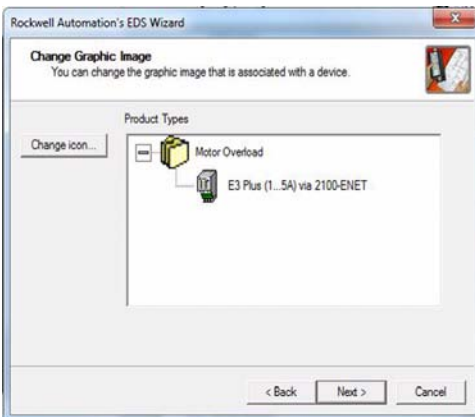



- Click Next to register the device.

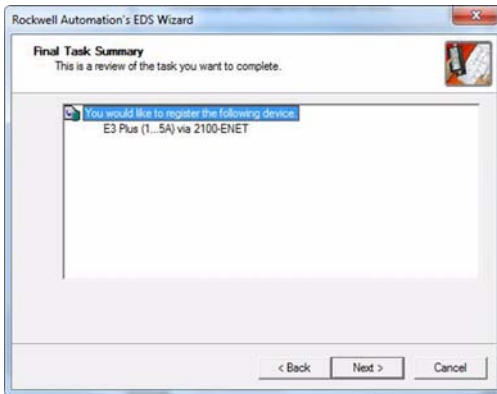

- Click Finish.

## Logix Controller I/O Messaging

RSLogix 5000 software is used to configure I/O messaging between a Logix controller and an E3 Plus EtherNet/IP adapter on an EtherNet/IP network. Follow these steps to configure a Logix controller for I/O messaging.

- Right-click on the EtherNet/IP scanner in I/O Configuration and select New Module to open the Select Module Type dialog box.
- Select Generic Ethernet Module and click OK.
- Enter a name for the E3 Plus EtherNet/IP adapter.

The name creates a tag in RSLogix 5000 software that can be used to read and write data from the E3 Plus EtherNet/IP adapter.

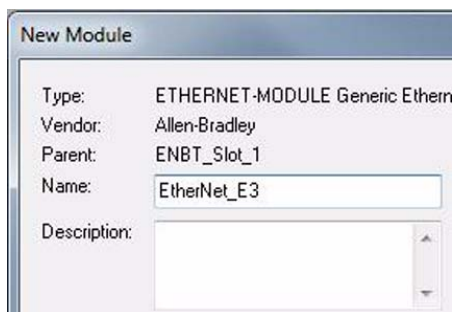

4. Select Data-INT for the Comm Format.

The Comm Format tells RSLogix 5000 software the format of the data. The Data-INT format represents the data from the E3 Plus EtherNet/IP adapter as a field of 16-bit values.

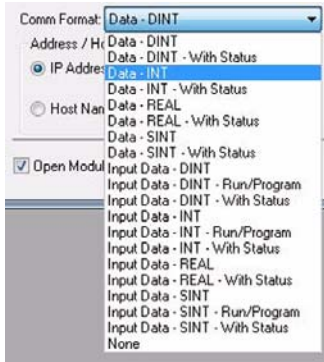

5. Set the Connection Parameters.

I/O data is accessed using Input Instance 100 and Output Instance 103 (for E3 standard) or 105 (for E3 Plus) by default.

---

**IMPORTANT** If you have already changed the Input and Output Assemblies, you will need to enter those values instead of the default values.

---

The size of the input connection and the output connection shall correspond to the size of the chosen instance. For Instance 100, the size is 6. For Instances 103 and 105, the size is 1. The E3 Plus EtherNet/IP adapter Configuration Assembly Instance is 6. Currently, the 2100-ENET adapter does not support the configuration assembly.

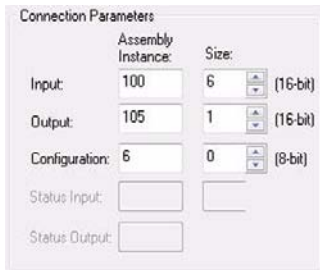

**Output Assembly - Instance 105**

Bit	Contents
0	OutA
1	OutB
2	Fault Reset
3	Not Used
4	Not Used
5	Remote Reset
6	Not Used
7	Not Used

**Input Assembly - Instance 100**

Byte Size	Contents
2 Bytes	Header information (Pad Word)
2 Bytes	Header information (Pad Word)
2 Bytes	Value of parameter pointed to by parameter #61
2 Bytes	Value of parameter pointed to by parameter #62
2 Bytes	Value of parameter pointed to by parameter #63
2 Bytes	Value of parameter pointed to by parameter #64

6. Enter the IP address of the E3 Plus EtherNet/IP adapter.

Address / Host Name

IP Address: 192 . 168 . 10 . 85

Host Name:

7. Click Next.

- Enter a value for the time between each scan of the adapter.

Make sure Inhibit Module is not checked.

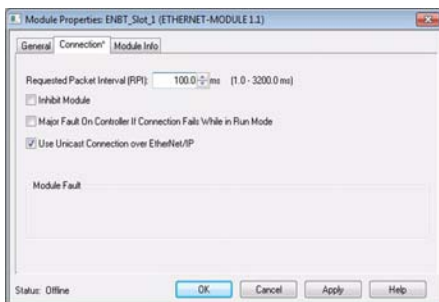

- Click Finish to add the E3 Plus EtherNet/IP adapter to the I/O Configuration in RSLogix 5000 software.

Name	Value	Force Mask	Style	Data Type
- EtherNet_E3:C	{...}	{...}		AB:ETHERNET_...
+ EtherNet_E3:C.Data	{...}	{...}	Hex	SINT[400]
- EtherNet_E3:I	{...}	{...}		AB:ETHERNET_...
+ EtherNet_E3:I.Data	{...}	{...}	Decimal	INT[6]
- EtherNet_E3:O	{...}	{...}		AB:ETHERNET_...
+ EtherNet_E3:O.Data	{...}	{...}	Decimal	INT[1]

## Additional Resources

These documents contain additional information concerning related products from Rockwell Automation.

Resource	Description
Ethernet Design Considerations Reference Manual, publication <a href="#">ENET-RM002</a>	Provides explanation of the following Ethernet concepts: <ul style="list-style-type: none"> <li>Network Layout and Components</li> <li>Network Infrastructure Devices</li> <li>Network Infrastructure Features</li> <li>Protocol</li> </ul>
Industrial Automation Wiring and Grounding Guidelines, publication <a href="#">1770-4.1</a>	Provides general guidelines for installing a Rockwell Automation industrial system.
Product Certifications website, <a href="http://www.ab.com">http://www.ab.com</a>	Provides declarations of conformity, certificates, and other certification details.

You can view or download publications at <http://www.rockwellautomation.com/literature/>. To order paper copies of technical documentation, contact your local Allen-Bradley distributor or Rockwell Automation sales representative.

Allen-Bradley, Rockwell Software, Rockwell Automation, RSLinx, and RSLogix 5000 are trademarks of Rockwell Automation, Inc.

Trademarks not belonging to Rockwell Automation are property of their respective companies.

[www.rockwellautomation.com](http://www.rockwellautomation.com)

### Power, Control and Information Solutions Headquarters

Americas: Rockwell Automation, 1201 South Second Street, Milwaukee, WI 53204-2496 USA, Tel: (1) 414.382.2000, Fax: (1) 414.382.4444  
Europe/Middle East/Africa: Rockwell Automation NV, Pegasus Park, De Kleetlaan 12a, 1831 Diegem, Belgium, Tel: (32) 2 663 0600, Fax: (32) 2 663 0640  
Asia Pacific: Rockwell Automation, Level 14, Core F, Cyberport 3, 100 Cyberport Road, Hong Kong, Tel: (852) 2887 4788, Fax: (852) 2508 1846