



Installation Instructions

Dataliner DL10 Message Display

This document describes how to install a Dataliner DL10 display in a panel or enclosure and connect power.

- European Union Directive Compliance
- wiring and safety guidelines
- enclosures
- required tools
- mounting dimensions
- clearances
- installing the DL10 display in a panel
- connecting AC power

For more information on the Dataliner DL10 display, refer to the Dataliner DL10 User Manual (Publication 2706-800).

European Union Directive Compliance

If a Dataliner Message Display is installed within the European Union or EFTA regions and has a CE mark, the following regulations apply.

EMC Directive

This apparatus is tested to meet Council Directive 89/336/EEC Electromagnetic Compatibility (EMC) using a technical construction file and the following standards in whole or in part.

- EN 50081-2 EMC – Generic Emission Standard, Part 2 - Industrial Environment
- EN 50082-2 EMC – Generic Immunity Standard, Part 2 - Industrial Environment

Dataliner products are intended for use in an industrial environment.

Low Voltage Directive

This apparatus is tested to meet Council Directive 73/23/EEC Low Voltage (LVD) with amendments, including 93/68/EEC using the pertinent sections of the following standards.

- EN 61131-2:1992 Programmable Controllers - Equipment Requirements and Tests
- EN 60950:1992 Safety of Information Technology Equipment

Intended Use of Product

According to these Standards, the factor which determines, for EMC purposes, whether an apparatus is deemed to be “Industrial” or “Residential, commercial and light industrial”, is given in Clause 1 of EN50081-2 as follows:

Apparatus covered by this standard is not intended for connection to a public mains network but is intended to be connected to a power network supplied from a high- or medium-voltage transformer dedicated for the supply of an installation feeding a manufacturing or similar plant.

This product is intended for use solely in an industrial environment as defined above. When installed in Europe, any other application is in contravention of European Union Directives, and a breach of these laws.

Wiring and Safety Guidelines

Install the Dataliner DL10 display using publication 70E, Electrical Safety Requirements for Employee Workplaces. In addition to the NFPA general guidelines, follow these recommendations:

- Connect the Dataliner display to its own branch circuit. The input power source should be protected by a fuse or circuit breaker rated at no more than 15 amps.
- Route incoming power to the DL10 display by a separate path from the communications cable.
- Where power and communication lines must cross, they should cross at right angles. Communications lines can be installed in the same conduit as low level DC I/O lines (less than 10 Volts).
- Grounding minimizes noise from Electromagnetic Interference (EMI) and is a safety measure in electrical installations. To avoid EMI, shield and ground cables appropriately.
- A source for grounding recommendations is the National Electrical Code published by the National Fire Protection Association of Boston.

Enclosures

Mount the DL10 display in a panel or enclosure to protect the internal circuitry. The display meets NEMA Type 12/13, 4 (indoor use), and 4X (for stainless steel faceplate versions) ratings only when properly mounted in a panel or enclosure with the equivalent rating.

Allow enough space within the enclosure for adequate ventilation. Consider heat produced by other devices in the enclosure. The ambient temperature around the display must be between 0° and 50°C (32° and 122°F).

Make provisions for accessing the back panel of the display for wiring, maintenance, and troubleshooting.

Required Tools

Other than the tools required to make the panel cutout, the tools required for installation are:

- 3/8 inch deep well socket wrench
- small slotted screwdriver
- torque wrench (in. / lbs).

Installing Display in Panel

To install the Dataliner display:



ATTENTION: Disconnect all electrical power from the panel before making cutout.

Make sure the area around the panel cutout is clear.

Take precautions so that metal cuttings do not enter any components that may already be installed in panel.

Failure to follow this warning may result in personal injury or damage to the panel components.

Mounting the DL10

The following figures provide panel cutout dimensions and overall dimensions for the DL10.

You can mount the DL10 in a custom panel or enclosure. Dataliner enclosure Catalog Number 2706-NE2 (four-line display) is available. When the DL10 is properly installed, the faceplate of the DL10 provides a NEMA Type 12/13, Type 4 (indoor use only), and 4X (for stainless steel faceplate version) enclosure integrity.

To install the DL10, perform the following steps:

1. Cut and drill the appropriate mounting holes in the enclosure or panel.



ATTENTION: Do not install the display in the panel or enclosure until all cutouts and holes are completed. Metal filings accumulated when cutting and drilling could enter ventilation holes on the display and cause the display to fail.

2. Remove the six mounting nuts from the hardware kit included with the DL10.
3. Position the DL10 in the panel or enclosure mounting hole.
4. Install and tighten the six nuts on the mounting studs to a torque of 14 in•lbs (1.6N•m) each.



ATTENTION: Mounting nuts must be tightened to a torque of 14 inch-pounds to provide a proper seal and to prevent potential damage to the display. Allen-Bradley assumes no responsibility for water or chemical damage to the display or other equipment within the enclosure because of improper installation.

Mounting Dimensions

Figure 1
Four Line Dimensions

Dimensions in Inches (Millimeters)

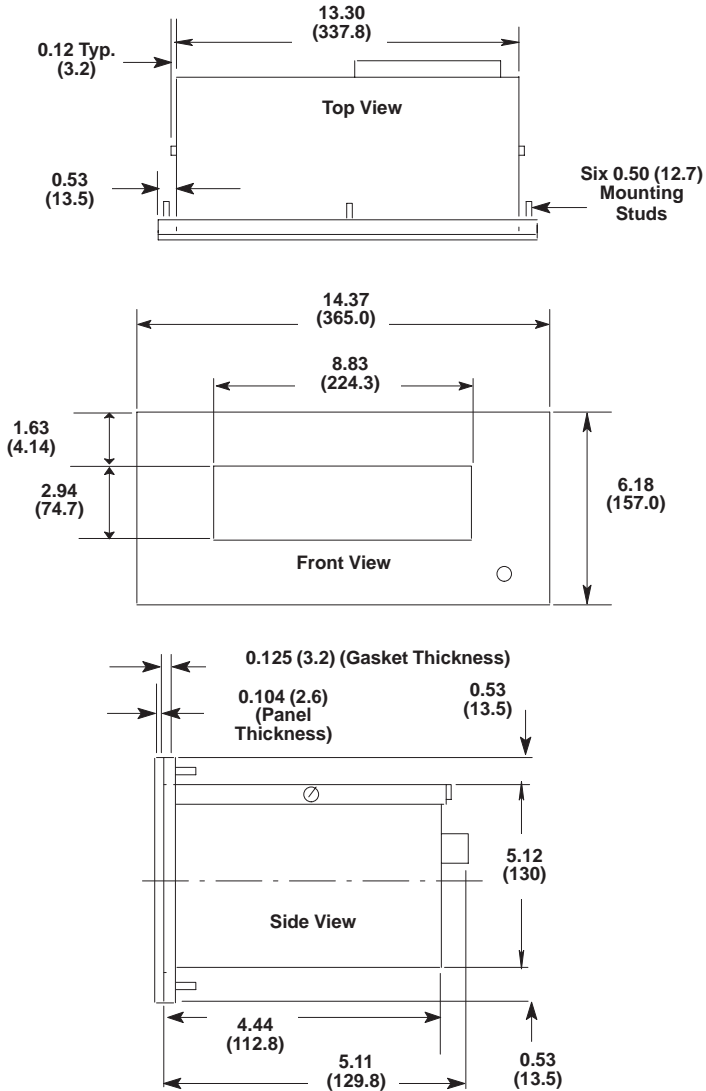

Clearances

Allow adequate clearances for mounting, air flow, maintenance, and wiring. See Figure 2.

Figure 2
Minimum Mounting Clearances

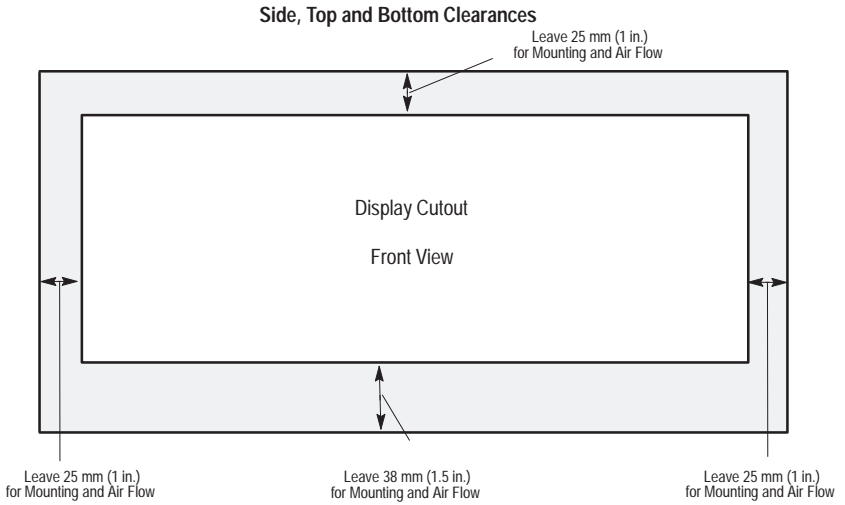

Cutout Dimensions

Figure 3 shows the required cut-out dimensions.

Figure 3
Dimensions in Inches (Millimeters)

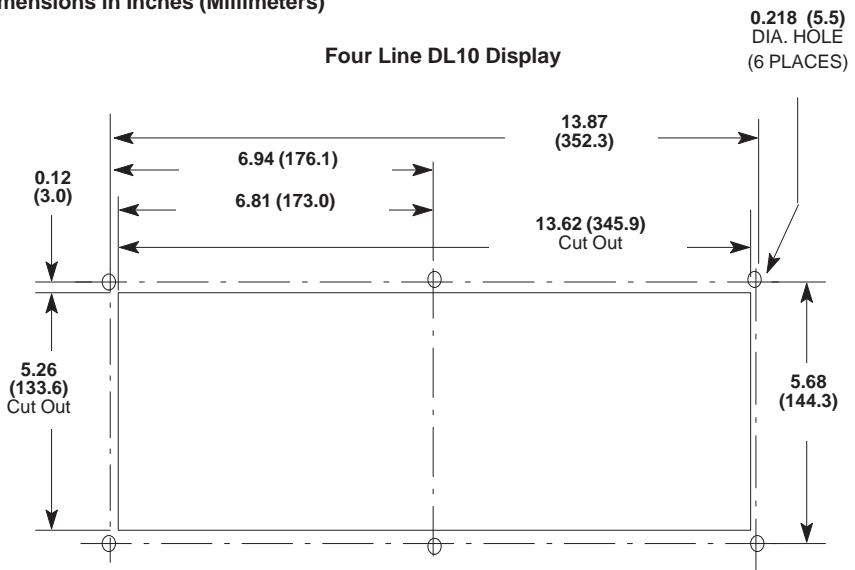

EMI Power-Line Filters (EU Installations Only)

DL10 displays intended for use in the European Union require a power-line filter. One line filter is required for each installed display. Two filter models are available. These filters are functionally identical, they differ only in termination style.

Schaffner Part No.	Termination Style
FN 660-3/06	Fast-On (Spade) connectors
FN 660-3/07	Wire leads

Line filters are available from an authorized Schaffner distributor.

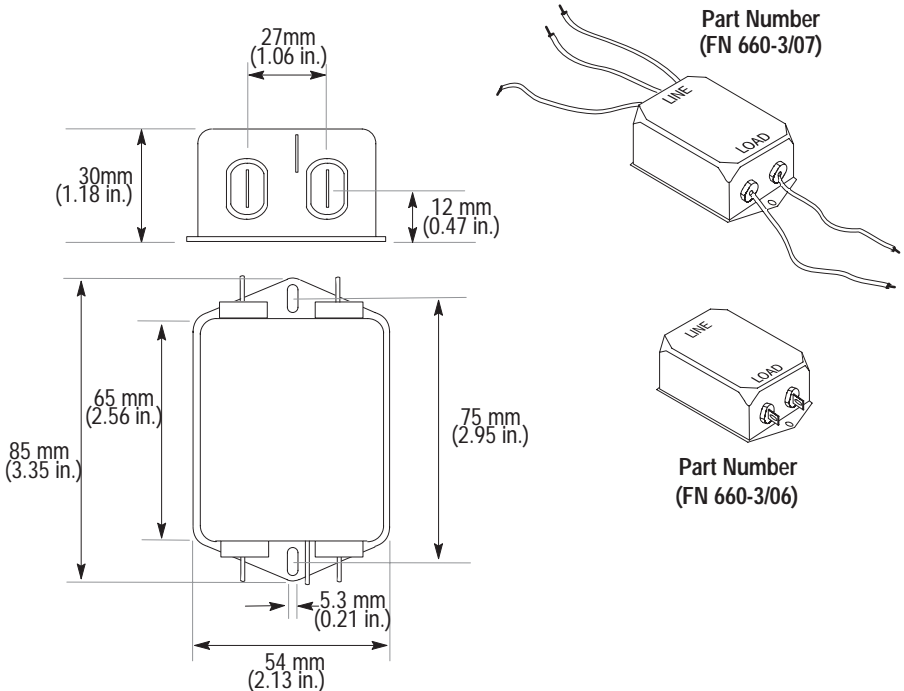

When properly installed, power-line filters prevent interference currents in the power lines. Interference currents can affect other devices on the same power line and other nearby equipment. Connect the Dataliner message display to the power-line filter as shown on the following page.

Connecting AC Power

The table below shows the electrical ratings for the Dataliner DL10 display.

Catalog Number	Supply Voltage	Power Consumption
2706-A41C 2706-A41J	120V ac, 60 Hz	55 VA maximum
2706-A42C 2706-A42J	240V ac, 50 Hz	55 VA maximum



ATTENTION: Terminal 3 (Protective Earth) must be connected to a reliable low impedance earth ground to protect the display from electrical noise. This ground connection will also protect personnel from electrical shock if the electronics short to the DL10 case.



ATTENTION: The Dataliner DL10 display is designed for safe use when installed in a suitably rated NEMA Type 12, 13, 4X (indoor use only), IP54 or IP65 enclosure.



ATTENTION: Do not apply power to the display until all wiring connections have been made. Failure to do so may result in electrical shock.

Wiring Guidelines (EU Installations Only)

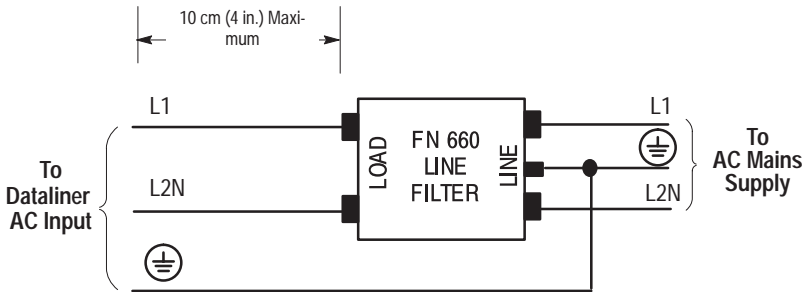

For installations within the European Union use the following guidelines to minimize Radio Frequency Interference (RFI) and achieve maximum Electromagnetic Compatibility (EMC).

- Follow all local safety regulations regarding proper grounding.
- Output leads from the power-line filter to the Dataliner must be 10 cm (4 in.) or less.
- Both Dataliner and power-line filter must be connected to a low impedance earth ground.
- All parts of the grounding system must be connected together with low impedance connections. Keep all ground connections as short as possible.
- Power-line filter must be connected to earth ground before connecting the power source.
- Do not run signal wiring and power wiring in the same conduit.
- When control or communication wires must cross, they should cross at an angle as close to 90 degrees as possible.
- Follow Dataliner display shielded cable requirements as specified in the user manual.
- Make sure cable shielding connections and terminations are connected as specified in the appropriate Dataliner User Manual.
- Keep the filter line side leads well separated from the load side leads.

Wiring Diagram

The following diagram shows how to connect the power-line filter for installations within the European Union. For non-European Union installations, the power-line filter can be omitted. For all other wiring connections refer to the DL10 User Manual (Publication 2706-800).

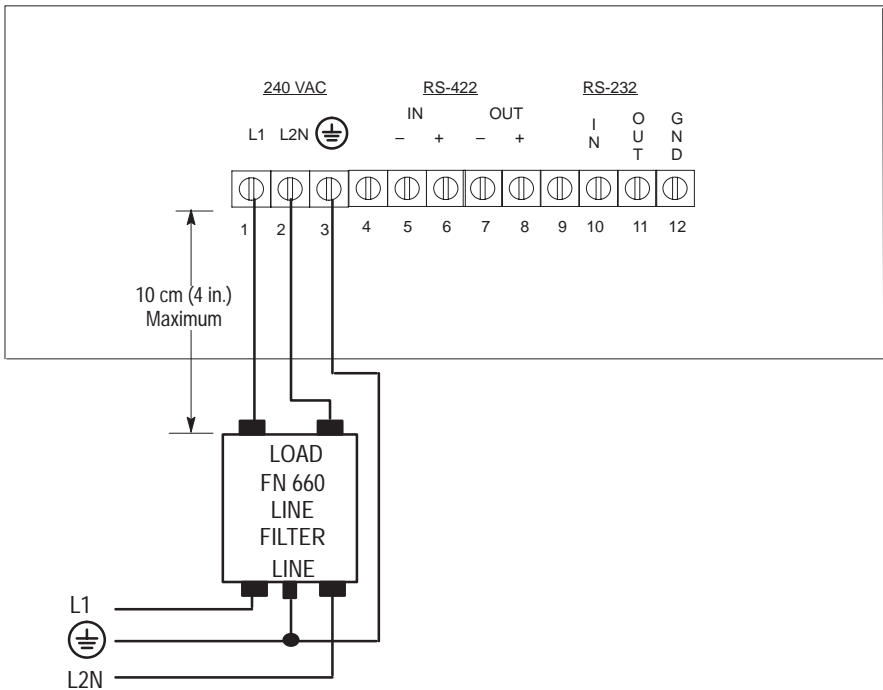

Fuse Replacement

The four line Series B and later DL10 display has two fuses. To determine if one of the fuses is bad, remove power to the display and then remove the top cover of the display by loosening the three cover screws. Check and replace one or both fuses if necessary.

Main Fuse – 1.5 Amp, Type MDL, 250V ac

FU1 on Auxiliary Power Supply – 0.375 Amp, Type MDL, 250V ac.

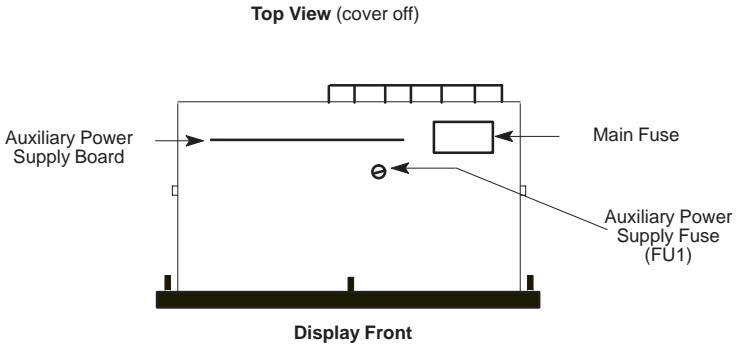

AC Power Connections

Connection	120/240V ac, 3 Wire U.S. Color Code	120/240V ac, 3 Wire European Harmonized Color Code
L1	Black (Line)	Brown (Line)
L2N	White (Neutral)	Blue (Neutral)
P.E.	Green (Earth Ground)	Green/Yellow (Protective Earth)

Additional Information

For additional information on communication port wiring and display configuration, refer to the Dataliner DL10 User Manual (Publication 2706-800).

Notes:

Allen-Bradley Repla



Allen-Bradley

Worldwide representation.



Argentina • Australia • Austria • Bahrain • Belgium • Brazil • Bulgaria • Canada • Chile • China, PRC • Colombia • Costa Rica • Croatia • Cyprus • Czech Republic • Denmark • Ecuador • Egypt • El Salvador • Finland • France • Germany • Greece • Guatemala • Honduras • Hong Kong • Hungary • Iceland • India • Indonesia • Ireland • Israel • Italy • Jamaica • Japan • Jordan • Korea • Kuwait • Lebanon • Malaysia • Mexico • Netherlands • New Zealand • Norway • Pakistan • Peru • Philippines • Poland • Portugal • Puerto Rico • Qatar • Romania • Russia–CIS • Saudi Arabia • Singapore • Slovakia • Slovenia • South Africa, Republic • Spain • Sweden • Switzerland • Taiwan • Thailand • Turkey • United Arab Emirates • United Kingdom • United States • Uruguay • Venezuela • Yugoslavia

Allen-Bradley Headquarters, 1201 South Second Street, Milwaukee, WI 53204 USA, Tel: (1) 414 382-2000 Fax: (1) 414 382-4444

41061-017-01(B)

Copyright 1999 Allen-Bradley Company, Inc. Printed in USA