



Allen-Bradley

*Bulletin 2707
Getting Started
with DTAM Plus*

User Manual

Allen-Bradley PLCs

Important User Information

Solid state equipment has operational characteristics differing from those of electromechanical equipment. “Safety Guidelines for the Application, Installation and Maintenance of Solid State Controls” (Publication SGI-1.1) describes some important differences between solid state equipment and hard-wired electromechanical devices. Because of this difference, and also because of the wide variety of uses for solid state equipment, all persons responsible for applying this equipment must satisfy themselves that each intended application of this equipment is acceptable.

In no event will the Allen-Bradley Company be responsible or liable for indirect or consequential damages resulting from the use or application of this equipment.

The examples and diagrams in this manual are included solely for illustrative purposes. Because of the many variables and requirements associated with any particular installation, the Allen-Bradley Company cannot assume responsibility or liability for actual use based on the examples and diagrams.

No patent liability is assumed by Allen-Bradley Company with respect to use of information, circuits, equipment, or software described in this manual.

Reproduction of the contents of this manual, in whole or in part, without written permission of the Allen-Bradley Company is prohibited.

Throughout this manual we use notes to make you aware of safety considerations.



ATTENTION: Identifies information about practices or circumstances that can lead to personal injury or death, property damage, or economic loss.

Attentions help you:

- identify a hazard
- avoid the hazard
- recognize the consequences

Important: Identifies information that is especially important for successful application and understanding of the product.

Using This Manual

Chapter 1

Chapter Objectives	1-1
Overview of this Manual	1-1
Intended Audience	1-2
Conventions	1-2
Related Publications	1-2

What You Need

Chapter 2

Chapter Objectives	2-1
Personal Computer Requirements	2-1
DTAM Plus Programming Software	2-1
DTAM Plus Hardware	2-2
SLC Hardware	2-3

Sample Application Overview

Chapter 3

Chapter Objectives	3-1
Application Flowchart	3-1
Screen Descriptions	3-2

Installing DTAM Plus Programming Software

Chapter 4

Chapter Objectives	4-1
Checking Available Memory	4-1
Installing DTAM Plus Programming Software	4-1

Creating a Sample Application

Chapter 5

Chapter Objectives	5-1
Starting DTAM Plus	5-1
Creating a New Application File	5-2
Entering DTAM Plus Configuration Data	5-4
Creating Application Screens	5-9
Main Menu (Screen 1)	5-9
Sub-Menu (Screen 20)	5-10
Data Display (Screen 22)	5-11
Data Display (Screen 23)	5-14
Data Display (Screen 27)	5-16
Data Display (Screen 29)	5-20
Data Entry (Screen 21)	5-24
Data Entry (Screen 40)	5-27
Security Screen (Screen 39)	5-29
Bar Graph (Screen 11)	5-30
Recipe Screen (Screen 28)	5-32

Creating a Sample Application

Chapter 5 (continued)	
Linking Application Screens	5-34
Main Menu Links	5-34
Sub-Menu Links	5-35
Link Screen 21 Back to Main Menu	5-36
Link Screen 22 Back to Main Menu	5-36
Link Screen 23 Back to Main Menu	5-37
Link Screen 11 Back to Main Menu	5-37
Link Screen 39 to Screen 27	5-38
Link Screen 27 to Screen 28	5-38
Link Screen 28 to Screen 29	5-39
Link Screen 29 Back to Main Menu	5-39
Link Screen 40 Back to Main Menu	5-40
Creating Alarm Screen	5-41
Edit Background Monitor	5-43
Saving the Application	5-44

Downloading the Application

Chapter 6	
Chapter Objectives	6-1
Download DIP Switch Settings	6-1
Download Connections	6-2
Downloading the Application	6-3

SLC Application File

Chapter 7	
Chapter Objectives	7-1
Configuring the SLC 500	7-1
Preloaded Values	7-1
Ladder Logic Program	7-2

Running the Application

Chapter 8	
Chapter Objectives	8-1
DTAM Plus DIP Switch Settings	8-1
SLC 500 Connections	8-2
Running the Application	8-3

	Figures	
3.1	Sample Application Flowchart	3-1
6.1	DIP Switch Settings for Download	6-1
6.2	Power and Download Connections	6-2
8.1	Typical DIP Switch Settings for SLC Operation	8-1
8.2	SLC 500 Connections	8-2
	Tables	
1.A	Chapter Descriptions	1-1
1.B	Related Publications	1-2

Using This Manual

Chapter Objectives

Read this chapter to familiarize yourself with the rest of the manual. You will learn about:

- Contents of this manual
- Intended audience
- Related publications

Overview of this Manual

Use this manual to become familiar with the operation of the DTAM Plus and the DTAM Plus Programming Software (Catalog No. 2707-NP). This manual describes how to create, load and run a sample application.

Table 1.A
Chapter Descriptions

Chapter	Title	Purpose
1	Using this Manual	Provides an overview of the manual.
2	What You Need	Covers equipment and software needed to create and run the sample application.
3	Sample Application Overview	Briefly describes the sample application.
4	Installing DTAM Plus Programming Software	Tells how to install the DTAM Plus Programming Software on your personal computer.
5	Creating a Sample Application	Gives step-by-step instructions for creating the sample application.
6	Downloading the Application	Explains how to transfer the application from your personal computer to the DTAM Plus.
7	SLC Application File	Provides the SLC ladder program required to run the sample application.
8	Running the Application	Describes how to run the sample application with an SLC 500.

Intended Audience

No special knowledge is needed to create and run the sample DTAM Plus application in this manual. You should understand the operation of an SLC 500 and also how to enter and load a ladder logic program.

Conventions

This manual uses the following conventions:

- Keys that you press on your personal computer keyboard are enclosed in brackets [].
For example: [Esc] refers to the Escape key
- [Return] refers to the carriage return key of your computer keyboard. This key may appear on your keyboard as [Enter] or [↵].
- Text strings that you enter on your computer keyboard are bold.
For example: Type **1 Pump Application** and press [Return]
- References to text that appears on your computer monitor are italicized.
For example: Pressing [Esc] returns you to the *Edit File* menu.

Related Publications

Table 1.B lists other publications you may require for additional reference.

Table 1.B
Related Publications

Publication / Catalog Number	Title
2707-800	DTAM Plus User Manual
2707-801	DTAM Plus Programming Manual
1747-800	SLC 500 Fixed Hardware Style Installation and Operation Manual
1747-804	SLC 500 Modular Hardware Style Installation and Operation Manual
1747-NM002	Advanced Programming Software User Manual

What You Need

Chapter Objectives

This chapter describes the hardware and software needed to run the sample application including:

- Personal Computer
- DTAM Plus Programming Software
- DTAM Plus Hardware
- SLC Hardware with Programmer.

Personal Computer Requirements

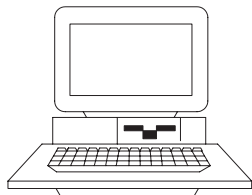

Personal Computer

A personal computer is required to enter and load an application into the DTAM Plus. The computer requirements are:

- IBM PC/AT or 100% compatible
- One or two floppy drives (720K minimum)
- Hard drive is recommended and required if only one floppy drive is present
- 640K of RAM
- DOS 3.0 or later
- Serial port on COM 1 or COM 2
- Monochrome or color monitor

DTAM Plus Programming Software



DPS Software

DTAM Plus Programming Software is used to create and download applications to the DTAM Plus. You need DTAM Plus Programming Software (Catalog No. 2707-NP) version 1.10 or later.

DTAM Plus Hardware

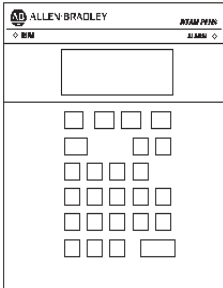

DTAM Plus

The sample application operates with the following versions of the DTAM Plus:

- 2707-L8P1 and 2707-L8P2
- 2707-L40P1 and 2707-L40P2
- 2707-V40P1 and 2707-V40P2
- 2707-V40P2N

Communication Cables

To connect the DTAM Plus to an SLC and personal computer, you need the following communication cables:

- Network Interface Cable (Catalog No. 2707-NC1)
- Upload/Download Cable (Catalog No. 2707-NC2)

Note: If constructing your own cables, use the cable diagrams in Chapter 4 of the DTAM Plus User Manual.

Power Cord

You need a standard 3-prong power cord.

SLC Hardware

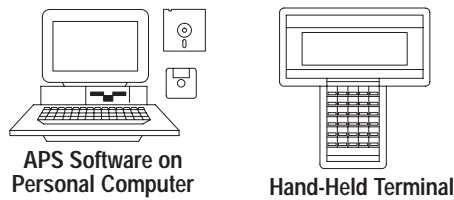
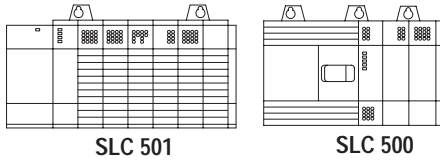

SLC Controller

The sample application operates with both fixed and modular style SLC 500 Controllers.

Programmer

You can program the SLC 500 with either a:

- Hand-Held Terminal (Catalog No. 1747-PT1)
- Advanced Programming Software (Catalog No. 1747-PA2E) on a personal computer

Note: APS software requires an Allen-Bradley T50 Industrial Terminal, T47 Portable Terminal, IBM PC/AT or 100% compatible personal computer. The computer requires 640K of RAM, a 10M hard drive, and DOS 3.0 or later. APS software is provided on both 3 1/2 inch and 5 1/4 inch diskettes.

Cables

To connect the Hand-Held Terminal (HHT) to an SLC 500, use this cable:

- SLC Communications Cable (Catalog No. 1747-C10)

To connect a personal computer to the SLC 500, use the following:

- SLC Communications Cable (Catalog No. 1747-C10)
- Personal Computer Interface Converter (Catalog No. 1747-PIC)

Sample Application Overview

Chapter Objectives

This chapter gives a description of the sample application you are going to enter. Understanding the function of the application will help you understand the configuration instructions in Chapter 5.

Application Flowchart

Figure 3.1 illustrates the sequence of operator screens that are displayed using the sample application.

Figure 3.1
Sample Application Flowchart

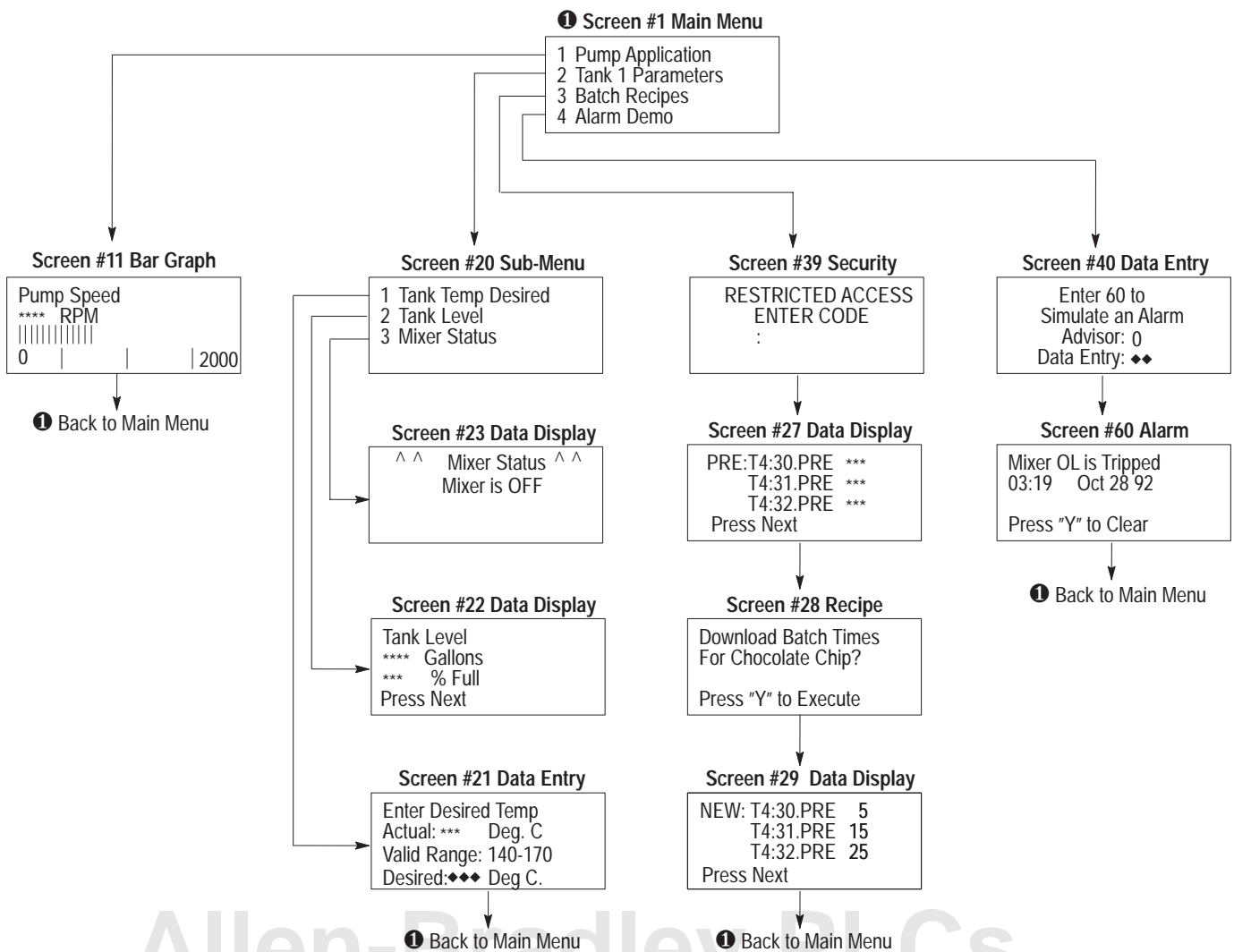

Screen Descriptions

```

1 Pump Application
2 Tank 1 Parameters
3 Batch Recipes
4 Alarm Demo
  
```

```

1 Tank Temp Desired
2 Tank Level
3 Mixer Status
  
```

```

Pump Speed
**** RPM
|||||
0 | | | | 2000
  
```

```

Enter Desired Temp
Actual: *** Deg. C
Valid Range: 140-170
Desired: ◆◆◆
  
```

```

Enter 60 to
Simulate an Alarm
Advisor: 0
Data Entry: ◆◆
  
```

```

Tank Level
**** Gallons
*** % Full
Press Next
  
```

Main Menu (Screen #1)

The Main Menu is the first screen displayed when the DTAM Plus is in the Run Mode. From this menu an operator can select one of four items by pressing the number of the selection.

Sub-Menu (Screen #20)

Screen #20 is the Tank 1 Sub-Menu. From this screen an operator can monitor or change tank parameters by pressing the number of the selection.

Bar Graph (Screen #11)

The Bar Graph Screen displays both a numeric and graphical representation of pump speed in RPM. In the sample application, this is the value of SLC timer T4:11.ACC.

Data Entry Screen (Screen #21)

Using this screen, an operator can enter a new tank temperature setpoint. Data for the actual temperature is the contents of SLC integer file N7:20. Operator data entry for the desired temperature is stored in SLC integer file N7:21.

Data Entry Screen (Screen #40)

The Alarm Data Entry Screen allows the operator to trigger Alarm Screen #60. When the operator enters a value of 60, the value is loaded into the DTAM Plus Advisor register which triggers the alarm. The Advisor register file is the SLC register file N7:0. The alarm acknowledge bit is N7:1/1. The alarm acknowledge bit is set when the alarm is acknowledged. The SLC ladder program uses this bit to move the value 0 into the alarm register and clear the alarm screen.

Data Display Screen (Screen #22)

Screen #22 simulates the tank fluid level in both gallons and percent full. The gallons register reads the contents of SLC integer file N7:22. The percent full register reads the contents of SLC integer file N7:23.

```
^ ^ Mixer Status ^ ^  
Mixer is OFF
```

```
RESTRICTED ACCESS  
ENTER CODE  
:
```

```
PRE:T4:30.PRE ***  
T4:31.PRE ***  
T4:32.PRE ***  
Press Next
```

```
Download Batch Times  
For Chocolate Chip?  
  
Press "Y" to Execute
```

```
NEW: T4:30.PRE 5  
T4:31.PRE 15  
T4:32.PRE 25  
Press Next
```

```
Mixer OL is Tripped  
03:19 Oct 28 92  
  
Press "Y" to Clear
```

Data Display Screen (Screen #23)

Screen #23 simulates the status of the Tank 1 mixer motor. The second line displays the mixer status (Mixer ON or Mixer OFF) and is controlled by the status of SLC bit B3:0/0.

Security Screen (Screen #39)

Screen #39 restricts access to the recipe screens. The operator must enter one of the following passwords:

1234 [←_]

5678 [←_]

1992 [←_]

Data Display Screen (Screen #27)

Screen #27 displays the current timer preset values for the recipe. The display registers are SLC timers T4:30.PRE, T4:31.PRE and T4:32.PRE. Pressing [NEXT] advances the operator to screen #28.

Recipe Screen (Screen #28)

Screen #28 is the Recipe Screen. The text prompts the operator to download the timer values for the recipe. When the operator presses [Y], the new value is loaded into the SLC timers and screen #29 is displayed.

Data Display Screen (Screen #29)

Screen #29 displays the new timer preset values after the recipe is downloaded.

Alarm Screen (Screen #60)

The Alarm Screen indicates the date and time the alarm occurred. Pressing [Y] clears the display and returns the operator back to the Main Menu.

Installing DTAM Plus Programming Software

Chapter Objectives

This chapter shows how to install the DTAM Plus Programming Software (Catalog No. 2707-NP) on your personal computer.

Checking Available Memory

You should have at least 640K available RAM to run the DTAM Plus Programming Software on your computer. Check the available RAM on your computer using the CHKDSK command.

Installing DTAM Plus Programming Software

This section shows how to install the software on a personal computer with at least 1 hard drive and 1 floppy or micro drive. The software is supplied on both 5 1/4 and 3 1/2 inch disks. Use the size appropriate for your computer.

1. Turn on your computer. Your computer will display the currently active drive: A:, B:, or C:
2. Insert the installation diskette for the DTAM Plus Programming Software into the floppy drive.
3. Select the drive containing the diskette (**A:** or **B:**) and press [Return]. Normally this is the A: drive.

```
C:> a: [Return]
```

```
A:>
```

4. Type **install** and press [Return] to start the installation.

```
A:> install [Return]
```

The following screen appears:

```
This program will install DTAM Plus Programming Software Version 1.10  
on your computer system and verify the integrity of the  
distribution disk(s).
```

```
You may press the [Esc] key at any time to abort the installation.
```

```
Each question has a default answer. If the default answer is  
correct, press the ENTER key in response to the question.  
Otherwise, type the answer and then press the ENTER key.
```

```
Press [Esc] to quit, any other key to continue ...
```

Installing DTAM Plus Programming Software

5. Press any key (other than [Esc]) to continue.

This screen displays.

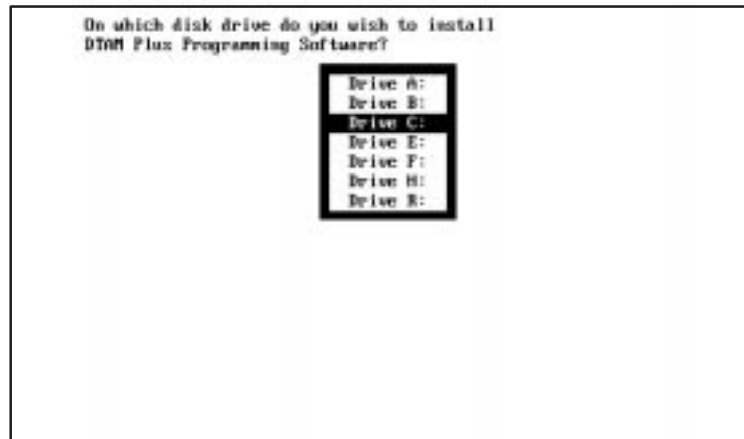

You cannot install the software on the same drive the Install program resides.

6. Use the [↑↓] arrow keys to highlight the drive on which you want to install the DTAM Plus Programming Software and then press [Return]. The default drive is C:

This screen appears.

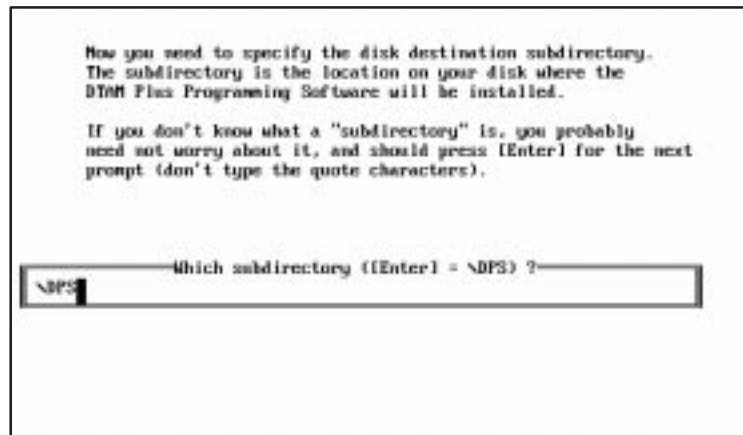

☞ *You can specify another directory. The Install program will create the directory if it does not exist.*

7. Press [Return] to install the DTAM Plus Programming Software in the \DPS subdirectory. The Install program creates the subdirectory.

The Install program displays status information on your screen during the installation.

The DPS Configuration Utility screen then appears:

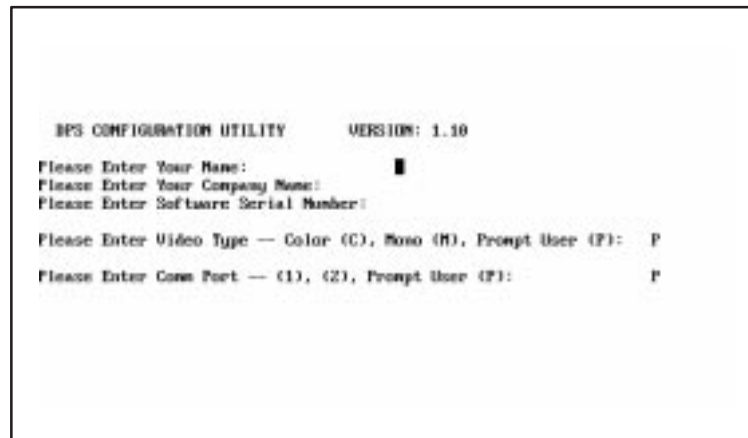

☞ *Press [Return] at the Video Type and Comm Port questions to prompt the user for this information during application development.*

8. Enter your name, company name, and software serial number (on registration card). Also, enter the monitor type and communication port used by your computer.
9. After responding to the above questions, you are asked to confirm the configuration. Press [Return] to accept the configuration.
10. The installation is complete. You are returned to DOS at the new subdirectory C: \DPS>.

Go to the next chapter. You will use the DTAM Plus Programming Software to create the sample application.

Creating a Sample Application

Chapter Objectives

This chapter provides step-by-step instructions on how to create the sample application described in Chapter 3. It shows how to:

- start the DTAM Plus Programming Software
- create an application file
- enter configuration data
- create application screens
- link application screens
- create an alarm screen
- save the application and exit the software

Starting DTAM Plus

☞ *If you installed the software in another subdirectory, move to that directory.*

To run the DTAM Plus Programming Software:

1. Verify that you are at the \DPS subdirectory where the software resides. If you are not, enter **cd DPS** and press [Return].

```
C:\DPS>
```

2. Type **DPS** and press [Return] to start the program.

```
C:\DPS> DPS [Return]
```

3. Specify whether you are using a color monitor. Enter **Y** or **N**.

4. The startup screen displays. It identifies the DPS version and licensed owner. A phone support number is provided for your assistance.



Starting DTAM Plus

To run the DTAM Plus Programming Software:

5. Press any key to continue.

The *Opening Menu* displays.

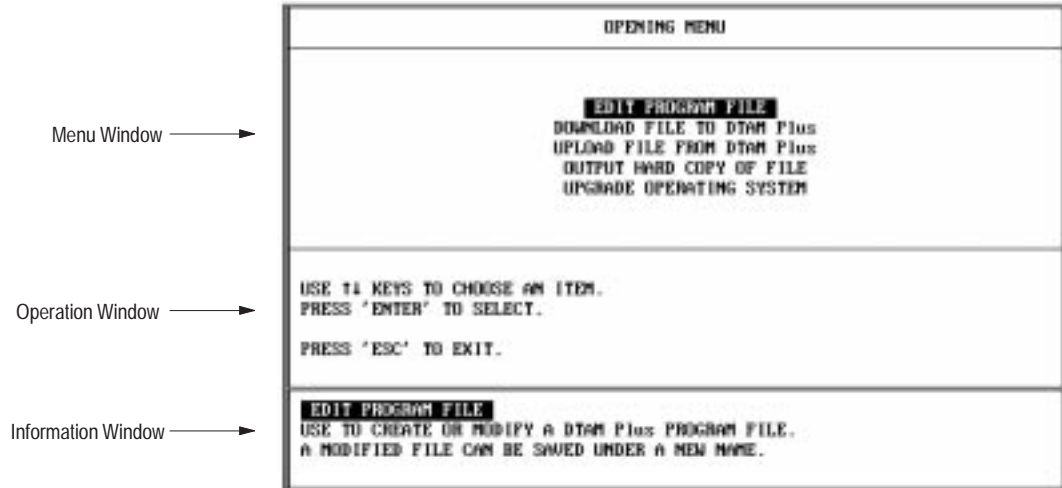

You are now ready to create a file for your application.

Creating a New Application File

The first thing you need to do is create a file in which to store your application.

1. Press [Return] to select *Edit Program File* from the *Opening Menu*.

The following screen appears.

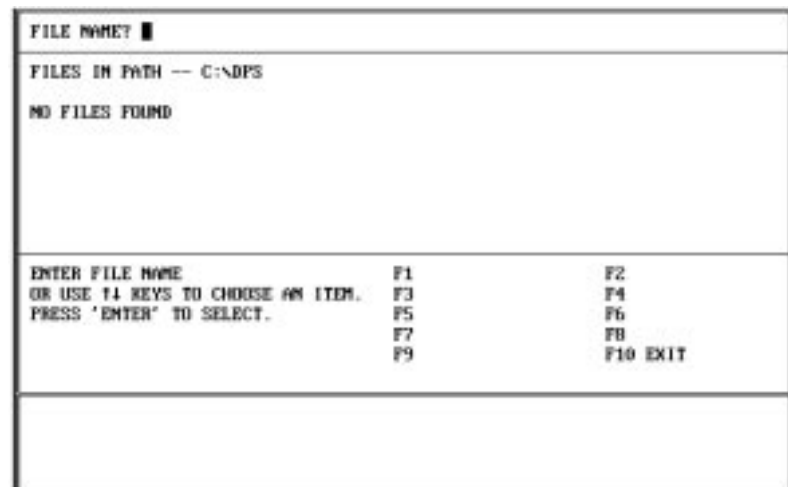

2. Type **demo** and press [Return] at the File Name? prompt. The file is created in the \DPS subdirectory with the .CFG file extension.

The screen then displays communication options.

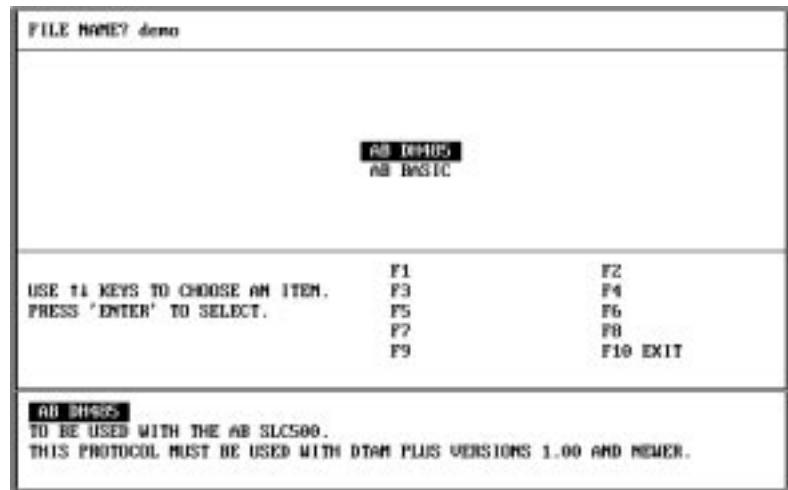

3. Press [Return] to select *AB DH485* as the communication protocol for the application.

The *Edit File* menu displays.

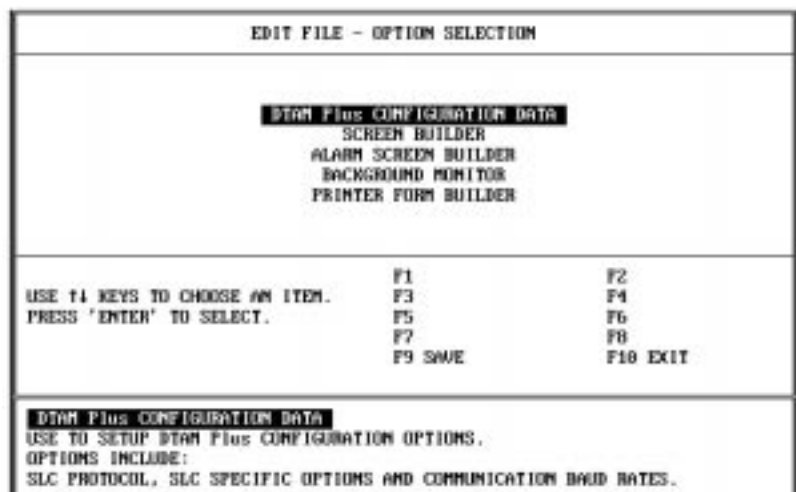

Continue to the next section to enter configuration data.

Entering DTAM Plus Configuration Data

Now, you will enter configuration data for the DTAM Plus and the SLC 500 processor.

1. Press [Return] to select *DTAM Plus Configuration Data* from the *Edit File* menu.

The *DPS Configuration* menu appears.

```

DPS CONFIGURATION - OPTION SELECTION

UPDATE INTERVAL
DTAM Plus ADVISOR
TIME SYNCHRONIZATION
SET MASTER SECURITY CODE
SPECIAL SECURITY SCREEN
PRINTER PORT PARAMETERS
SLC HARDWARE PARAMETERS

USE F4 KEYS TO CHOOSE AN ITEM.      F1          F2
PRESS 'ENTER' TO SELECT.            F3          F4
                                      F5          F6
                                      F7          F8
                                      F9 SAVE    F10 EXIT

UPDATE INTERVAL
THIS IS USED TO CONTROL HOW OFTEN THE DTAM Plus FOLLS THE SLC FOR DATA.
    
```

```

UPDATE INTERVAL
DTAM Plus ADVISOR
TIME SYNCHRONIZATION
SET MASTER SECURITY CODE
SPECIAL SECURITY SCREEN
PRINTER PORT PARAMETERS
SLC HARDWARE PARAMETERS
    
```

2. Use the arrow [\downarrow ↑] keys to highlight *DTAM Plus Advisor* and press [Return].

The *DPS Advisor* screen appears.

```

DPS ADVISOR

READ REGISTER NUMBER      ██████████
WRITE REGISTER NUMBER
ACK BIT
ACK BIT POLARITY         0

USE F4 KEYS TO CHANGE QUESTIONS.    F1          F2
ANSWER QUESTION AND PRESS 'ENTER'.  F3          F4
                                      F5          F6
PRESS 'ESC' WHEN DONE.              F7 CLEAR DATA  F8
                                      F9 SAVE        F10 EXIT

THIS IS THE LOCATION IN THE SLC THAT THE DTAM Plus WILL MONITOR FOR UNLID
SCREEN NUMBERS.
    
```

3. Enter the data below and press [Return] after entering each item:

Read Register Number = **N7:0**

Write Register Number = **N7:1**

ACK Bit Number = **1**

ACK Bit Polarity = **1**

The screen should look like this.

DPS ADVISOR		
READ REGISTER NUMBER		N7:0
WRITE REGISTER NUMBER		N7:1
ACK BIT		1
ACK BIT POLARITY		1
USE F1 KEYS TO CHANGE QUESTIONS.	F1	F2
ANSWER QUESTION AND PRESS 'ENTER'.	F3	F4
	F5	F6
PRESS 'ESC' WHEN DONE.	F7 CLEAR DATA	F8
	F9 SAVE	F10 EXIT
THIS IS THE LOCATION IN THE SLC THAT THE DTAM Plus WILL MONITOR FOR VALID SCREEN NUMBERS.		

4. Press [Esc] to save the data and return to the *DPS Configuration* menu.

DPS CONFIGURATION - OPTION SELECTION		
UPDATE INTERVAL		
DTAM Plus ADVISOR		
TIME SYNCHRONIZATION		
SET MASTER SECURITY CODE		
SPECIAL SECURITY SCREEN		
PRINTER PORT PARAMETERS		
SLC HARDWARE PARAMETERS		
USE F1 KEYS TO CHOOSE AN ITEM.	F1	F2
PRESS 'ENTER' TO SELECT.	F3	F4
	F5	F6
	F7	F8
	F9 SAVE	F10 EXIT
DTAM Plus ADVISOR		
USE TO SET THE DTAM Plus ADVISOR DATA.		

```

UPDATE INTERNAL
DTAM Plus ADVISOR
TIME SYNCHRONIZATION
SET MASTER SECURITY CODE
SPECIAL SECURITY SCREEN
PRINTER PORT PARAMETERS
SLC HARDWARE PARAMETERS
    
```

- Use the arrow [\downarrow] \uparrow] keys to highlight *SLC Hardware Parameters* and press [Return].

The *SLC 500 Configuration* menu appears.

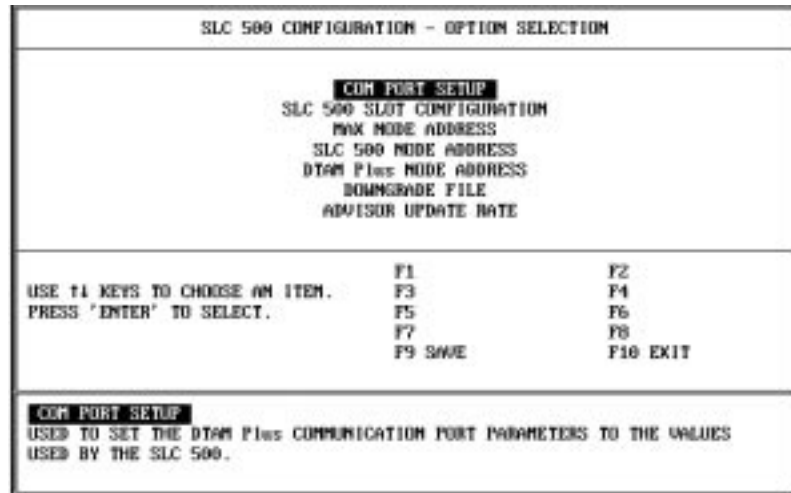

- Press [Return] to select *COM Port Setup*.

The *SLC COM Port Communication Parameters* screen appears with the current baud rate, parity and data bit settings displayed at the bottom. **The port must be set for 19200 baud rate, even parity, 8 data bits.**

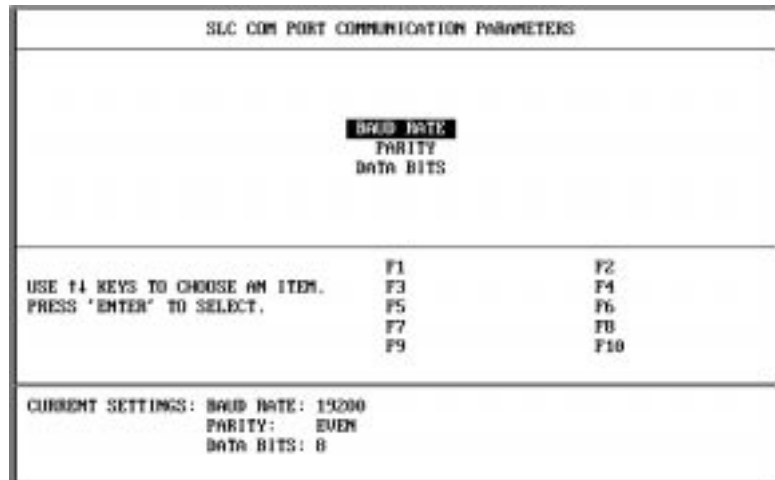

If necessary, modify the settings by selecting the appropriate menu item. The screen then displays a list of options for the selected parameter. Use the [\downarrow] \uparrow] arrow keys to highlight the correct setting and press [Return].

- Press [Esc] to return to the *SLC 500 Configuration* menu.

```
COM PORT SETUP
SLC 500 SLOT CONFIGURATION
MAX NODE ADDRESS
SLC 500 NODE ADDRESS
DTAM Plus NODE ADDRESS
DOWNGRADE FILE
ADVISOR UPDATE RATE
```

8. Select *DTAM Plus Node Address* from the menu.

The *DTAM Plus Node Address* screen appears.

AB CONFIGURATION - DTAM Plus NODE ADDRESS	
CURRENT ADDRESS:	0
ENTER NEW ADDRESS	█
ANSWER QUESTION.	
THE NODE ADDRESS IS USED BY THE PROTOCOL FOR NETWORKING. VALID NODE NUMBERS ARE BETWEEN 0 AND 31, INCLUSIVE.	

9. Enter **2** and press [Return] in the *New Address* field.

```
CURRENT ADDRESS:      2
ENTER NEW ADDRESS    █
```

10. Press [Esc] to return to the *SLC 500 Configuration* menu.

```

COM PORT SETUP
SLC 500 SLOT CONFIGURATION
MAX NODE ADDRESS
SLC 500 NODE ADDRESS
DTM Plus NODE ADDRESS
DOWNGRADE FILE
ADVISOR UPDATE RATE
    
```

11. Select *Advisor Update Rate* from the menu.

The following screen appears.

CURRENT UPDATE SETTING: 2.00	
ENTER UPDATE TIME:	<input type="text"/>
ANSWER QUESTION.	
<p>THE ADVISOR UPDATE RATE IS USED TO SET THE FREQUENCY THAT THE DTM Plus READS THE ADVISOR REGISTER. THE DEFAULT FOR THIS VALUE IS 2 SECONDS. VALID RATES ARE BETWEEN 1 & 12.75 SECONDS. CHANGING THIS VALUE TO A LARGER NUMBER WILL HELP IMPROVE NETWORK PERFORMANCE.</p>	

12. Enter **1.00** and press [Return] in the *Update Time* field.

```

CURRENT UPDATE SETTING: 1.00
ENTER UPDATE TIME: 
    
```

13. Press [Esc] to return to the *SLC 500 Configuration* menu.
14. Press [Esc] to return to the *DPS Configuration* menu.
15. Press [Esc] to return to the *Edit File* menu.

EDIT FILE - OPTION SELECTION		
<p>DTM Plus CONFIGURATION DATA SCREEN BUILDER ALARM SCREEN BUILDER BACKGROUND MONITOR PRINTER FORM BUILDER</p>		
USE F1 KEYS TO CHOOSE AN ITEM. PRESS 'ENTER' TO SELECT.	F1 F3 F5 F7 F9 SAVE	F2 F4 F6 F8 F10 EXIT
<p>DTM Plus CONFIGURATION DATA USE TO SETUP DTM Plus CONFIGURATION OPTIONS. OPTIONS INCLUDE: SLC PROTOCOL, SLC SPECIFIC OPTIONS AND COMMUNICATION BAUD RATES.</p>		

Continue to the next section to create the application screens.

Creating Application Screens

This section shows how to create the following application screens:

- Main Menu (Screen 1)
- Sub-Menu (Screen 20)
- Data Display (Screens 22, 23, 27, 29)
- Data Entry (Screens 21, 40)
- Security (Screen 39)
- Bar Graph (Screen 11)
- Recipe (Screen 28)

Main Menu (Screen 1)

1. Highlight *Screen Builder* on the *Edit File* menu and press [Return].

The following screen appears.

```
DTM Plus CONFIGURATION DATA
  SCREEN BUILDER
ALARM SCREEN BUILDER
BACKGROUND MONITOR
PRINTER FORM BUILDER
```

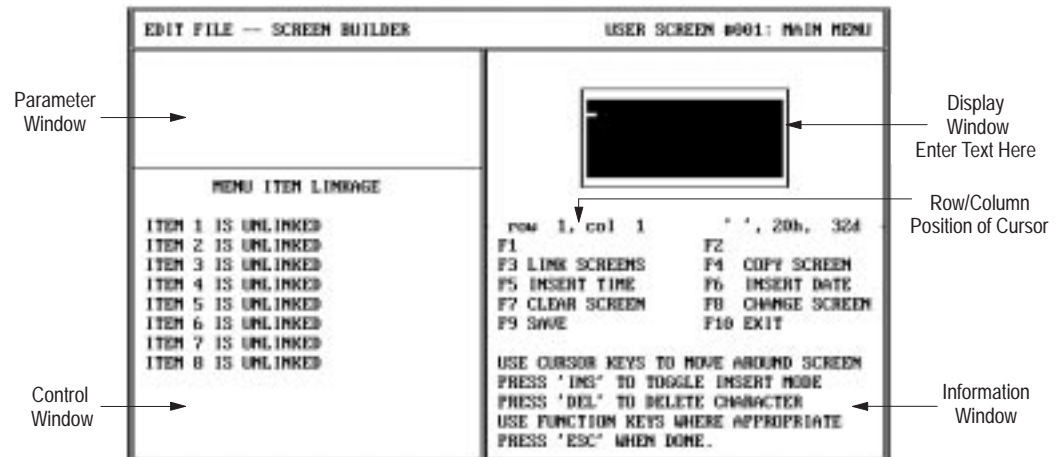

2. Enter the following data for the Main Menu. Press [Return] after entering each line:

- 1 Pump Application
- 2 Tank 1 Parameters
- 3 Batch Recipes
- 4 Alarm Demo

You have just created the Main Menu. It should look like this.

```
1 Pump Application
2 Tank 1 Parameters
3 Batch Recipes
4 Alarm Demo_
```

Continue to the next section to create the Sub-Menu.

Sub-Menu (Screen 20)

1. Press the [F8] function key to start a new screen.

The screen prompts you for a new screen number.



2. Type **20** and press [Return]. This is the number for the Sub-Menu.

The Main Menu clears and the screen displays a list of screen types.

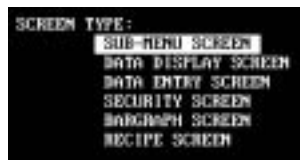

3. Press [Return] to select *Sub-Menu Screen*.
4. Enter the following data for the Sub-Menu. Press [Return] after entering each line:

- 1 Tank Temp Desired**
- 2 Tank Level**
- 3 Mixer Status**

You have just created the Sub-Menu. It should look like this.



Continue to the next section to create Data Display 22.

Data Display (Screen 22)

1. Press the [F8] function key to start a new screen.

The screen prompts you for a new screen number.



2. Type **22** and press [Return]. This is the number for the first Data Display.

The screen clears the Sub-Menu and displays a list of screen types:



3. Use the [↓↑] keys to highlight *Data Display Screen* and press [Return].
4. Enter the following data in the display window:

Type **Tank Level** and press [Return]

Enter 6 spaces, type **Gallons**, press [Return]

Enter 4 spaces, type **% Full**, press [Return]

Type **Press Next**

The screen should look like this.

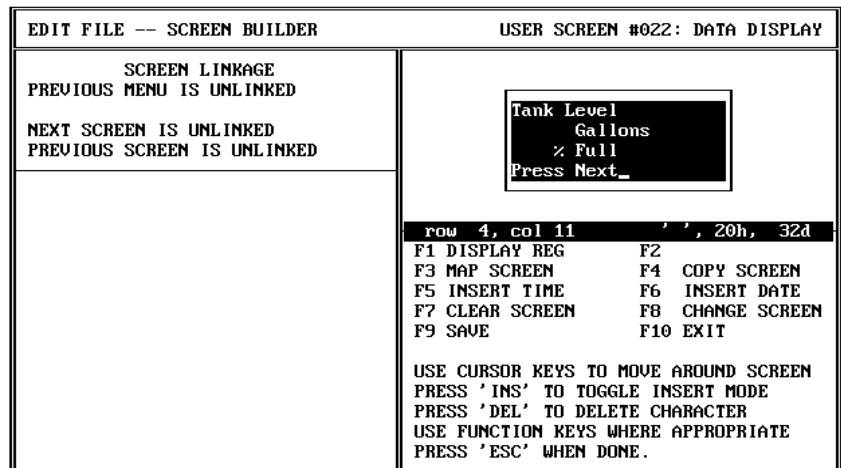

Note: You will now enter data registers for this screen.

⇒ Steps 5 – 9 define the data register for Gallons.

- Use the [↑↓][←→] arrow keys to move the cursor to row 2, column 1 (6 spaces to the left of the word Gallons).
- Press [F1] (Display Register).

The screen displays a list of register types.

```
SELECT REGISTER TYPE:
BIT
16 BIT SIGNED INTEGER
16 BIT UNSIGNED INTEGER
16 BIT BCD
16 BIT HEX
32 BIT UNSIGNED INTEGER
32 BIT BCD
32 BIT HEX
ASCII
```

- Use the [↓↑] keys to highlight *16 Bit Signed Integer* and press [Return].
The *16 Bit Signed Integer Display* appears.
- Use the arrow [↑↓] and [Return] keys to enter the register data below.

```
16 BIT SIGNED INTEGER DISPLAY
REGISTER NUMBER: 7722
DIGITS RIGHT OF DECIMAL: 0
DIGITS LEFT OF DECIMAL: 5
LEAVE PLACE FOR SIGN (Y OR N): N
SHOW LEADING ZEROS (Y OR N): N
MINIMUM REGISTER VALUE: 0
MAXIMUM REGISTER VALUE: 10000
MINIMUM DISPLAYED VALUE: 0
MAXIMUM DISPLAYED VALUE: 10000
```

Arrows indicate changes

- After pressing [Return] to enter the last line of register data, press [Esc] to accept the data.

The data display window shows 5 asterisks (*****) before Gallons indicating the data register position.

EDIT FILE -- SCREEN BUILDER	USER SCREEN #022: DATA DISPLAY										
<p>SCREEN LINKAGE PREVIOUS MENU IS UNLINKED</p> <p>NEXT SCREEN IS UNLINKED PREVIOUS SCREEN IS UNLINKED</p> <p>16 BIT SIGNED INTEGER DISPLAY</p> <p>REGISTER NUMBER: N7:22 DIGITS RIGHT OF DECIMAL: 0 DIGITS LEFT OF DECIMAL: 5 LEAVE PLACE FOR SIGN (Y OR N): N SHOW LEADING ZEROS (Y OR N): N MINIMUM REGISTER VALUE: 0 MAXIMUM REGISTER VALUE: 10000 MINIMUM DISPLAYED VALUE: 0 MAXIMUM DISPLAYED VALUE: 10000</p>	<div style="border: 1px solid black; padding: 5px; margin-bottom: 10px;"> <p>Tank Level ***** Gallons % Full Press Next</p> </div> <p>row 2, col 1 ' ', 20h, 32d</p> <table style="width: 100%; border: none;"> <tr> <td>F1 DISPLAY REG</td> <td>F2</td> </tr> <tr> <td>F3 MAP SCREEN</td> <td>F4 COPY SCREEN</td> </tr> <tr> <td>F5 INSERT TIME</td> <td>F6 INSERT DATE</td> </tr> <tr> <td>F7 CLEAR SCREEN</td> <td>F8 CHANGE SCREEN</td> </tr> <tr> <td>F9 SAVE</td> <td>F10 EXIT</td> </tr> </table> <p>USE CURSOR KEYS TO MOVE AROUND SCREEN PRESS 'INS' TO TOGGLE INSERT MODE PRESS 'DEL' TO DELETE CHARACTER USE FUNCTION KEYS WHERE APPROPRIATE PRESS 'ESC' WHEN DONE.</p>	F1 DISPLAY REG	F2	F3 MAP SCREEN	F4 COPY SCREEN	F5 INSERT TIME	F6 INSERT DATE	F7 CLEAR SCREEN	F8 CHANGE SCREEN	F9 SAVE	F10 EXIT
F1 DISPLAY REG	F2										
F3 MAP SCREEN	F4 COPY SCREEN										
F5 INSERT TIME	F6 INSERT DATE										
F7 CLEAR SCREEN	F8 CHANGE SCREEN										
F9 SAVE	F10 EXIT										

⇒ Steps 10 – 14 define the data register for % Full.

10. Use the [↓] arrow keys to move the cursor to row 3, column 1 (4 spaces to the left of % Full).
11. Press [F1] (Display Register).
The screen displays a list of register types.

```

SELECT REGISTER TYPE:
BIT
16 BIT SIGNED INTEGER
16 BIT UNSIGNED INTEGER
16 BIT BCD
16 BIT HEX
32 BIT UNSIGNED INTEGER
32 BIT BCD
32 BIT HEX
ASCII
    
```

12. Use the [↓↑] keys to highlight *16 Bit Signed Integer* and press [Return].
The *16 Bit Signed Integer Display* appears.
13. Use the arrow [↑↓] and [Return] keys to enter the register data below.

```

16 BIT SIGNED INTEGER DISPLAY
REGISTER NUMBER: 1723
DIGITS RIGHT OF DECIMAL: 0
DIGITS LEFT OF DECIMAL: 3
LEAVE PLACE FOR SIGN (Y OR N): N
SHOW LEADING ZEROS (Y OR N): N
MINIMUM REGISTER VALUE: 0
MAXIMUM REGISTER VALUE: 100
MINIMUM DISPLAYED VALUE: 0
MAXIMUM DISPLAYED VALUE: 100
    
```

Arrows indicate changes

14. After pressing [Return] to enter the last line of register data, press [Esc] to accept the data.
The data display window shows 3 asterisks (***) before % Full indicating the data register position.

EDIT FILE -- SCREEN BUILDER	USER SCREEN #022: Data Display										
<p>SCREEN LINKAGE PREVIOUS MENU IS UNLINKED NEXT SCREEN IS UNLINKED PREVIOUS SCREEN IS UNLINKED</p> <p>16 BIT SIGNED INTEGER DISPLAY</p> <p>REGISTER NUMBER: N7:23 DIGITS RIGHT OF DECIMAL: 0 DIGITS LEFT OF DECIMAL: 3 LEAVE PLACE FOR SIGN (Y OR N): N SHOW LEADING ZEROS (Y OR N): N MINIMUM REGISTER VALUE: 0 MAXIMUM REGISTER VALUE: 100 MINIMUM DISPLAYED VALUE: 0 MAXIMUM DISPLAYED VALUE: 100</p>	<div style="border: 1px solid black; padding: 5px; margin-bottom: 10px;"> <p>Tank Level ++++ Gallons *** % Full Press Next</p> </div> <p>row 3, col 1 ' ', 20h, 32d</p> <table style="width: 100%; border: none;"> <tr> <td>F1 DISPLAY REG</td> <td>F2</td> </tr> <tr> <td>F3 MAP SCREEN</td> <td>F4 COPY SCREEN</td> </tr> <tr> <td>F5 INSERT TIME</td> <td>F6 INSERT DATE</td> </tr> <tr> <td>F7 CLEAR SCREEN</td> <td>F8 CHANGE SCREEN</td> </tr> <tr> <td>F9 SAVE</td> <td>F10 EXIT</td> </tr> </table> <p>USE CURSOR KEYS TO MOVE AROUND SCREEN PRESS 'INS' TO TOGGLE INSERT MODE PRESS 'DEL' TO DELETE CHARACTER USE FUNCTION KEYS WHERE APPROPRIATE PRESS 'ESC' WHEN DONE.</p>	F1 DISPLAY REG	F2	F3 MAP SCREEN	F4 COPY SCREEN	F5 INSERT TIME	F6 INSERT DATE	F7 CLEAR SCREEN	F8 CHANGE SCREEN	F9 SAVE	F10 EXIT
F1 DISPLAY REG	F2										
F3 MAP SCREEN	F4 COPY SCREEN										
F5 INSERT TIME	F6 INSERT DATE										
F7 CLEAR SCREEN	F8 CHANGE SCREEN										
F9 SAVE	F10 EXIT										

Data Display (Screen 23)

1. Press the [F8] function key to start a new screen.
The screen prompts you for a new screen number.



2. Type **23** and press [Return].
The screen clears the previous screen and displays a list of screen types.



3. Highlight *Data Display Screen* and press [Return].
4. Type ^^ **Mixer Status** ^^ and press [Return] in the Data Display.
The screen should look like this.

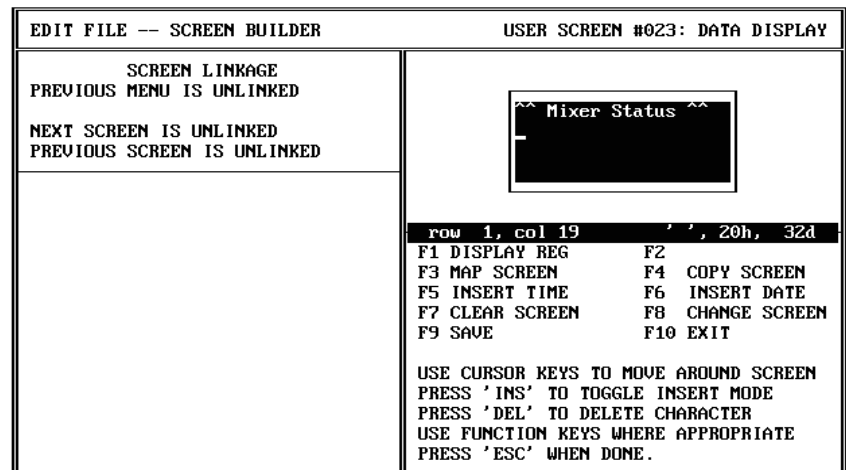

Note: You will now enter register data for this screen.

⇒ Steps 5 – 9 define the data register for Mixer Status

- Use the [↑↓][←→] arrow keys to move the cursor to row 2, column 4 of the display window.
- Press [F1] (Display Register).
The screen displays a list of register types.

```
SELECT REGISTER TYPE:
BIT
16 BIT SIGNED INTEGER
16 BIT UNSIGNED INTEGER
16 BIT BCD
16 BIT HEX
32 BIT UNSIGNED INTEGER
32 BIT BCD
32 BIT HEX
ASCII
```

- Press [Return] to select *Bit*.
The *Bit Display* appears.
- Use the arrow [↑↓] and [Return] keys to enter the following register data.

```
BIT DISPLAY
REGISTER NUMBER:  B3/0
BIT NUMBER:      Na
TEXT WHEN BIT IS OFF (0):
Mixer is OFF
TEXT WHEN BIT IS ON (1):
Mixer is ON
```

Arrows indicate changes

- Press [Esc] after entering the register data.

The data display window shows 12 asterisks in row 2 indicating the data register position.

EDIT FILE — SCREEN BUILDER	USER SCREEN #023: DATA DISPLAY
SCREEN LINKAGE PREVIOUS MENU IS UNLINKED NEXT SCREEN IS UNLINKED PREVIOUS SCREEN IS UNLINKED	<div style="border: 1px solid black; padding: 5px; margin: 10px auto; width: fit-content;"> Mixer Status ***** </div>
BIT DISPLAY REGISTER NUMBER: B3/0 BIT NUMBER: Na TEXT WHEN BIT IS OFF (0): Mixer is OFF TEXT WHEN BIT IS ON (1): Mixer is ON	<pre>row 2, col 4 ^ ^ , 20h, 32d F1 DISPLAY REG F2 F3 MAP SCREEN F4 COPY SCREEN F5 INSERT TIME F6 INSERT DATE F7 CLEAR SCREEN F8 CHANGE SCREEN F9 SAVE F10 EXIT USE CURSOR KEYS TO MOVE AROUND SCREEN PRESS "INS" TO TOGGLE INSERT MODE PRESS "DEL" TO DELETE CHARACTER USE FUNCTION KEYS WHERE APPROPRIATE PRESS "ESC" WHEN DONE.</pre>

Data Display (Screen 27)

1. Press the [F8] function key to start a new screen.
The screen prompts you for a new screen number



2. Type **27** and press [Return].
The screen clears the previous screen and displays a list of screen types.



3. Highlight *Data Display Screen* and press [Return].
4. Enter the following data in the display window:

Type **PRE:T4:30.PRE** and press [Return]

Enter 4 spaces, type **T4:31.PRE**, press [Return]

Enter 4 spaces, type **T4:32.PRE**, press [Return]

Type **Press Next** and press [Return]

The screen should look like this.



Note: You will now enter 3 data registers for this screen.

⇒ Steps 5 – 9 define the data register for line 1 of Screen 27.

- Use the [↑↓][←→] arrow keys to move the cursor to row 1, column 15 of the display window.
- Press [F1] (Display Register).

The screen displays a list of register types.

```

SELECT REGISTER TYPE:
BIT
16 BIT SIGNED INTEGER
16 BIT UNSIGNED INTEGER
16 BIT BCD
16 BIT HEX
32 BIT UNSIGNED INTEGER
32 BIT BCD
32 BIT HEX
ASCII
    
```

- Highlight *16 Bit Signed Integer* and press [Return].

The *16 Bit Signed Integer Display* appears.

- Use the arrow [↑↓] and [Return] keys to enter the following register data.

```

16 BIT SIGNED INTEGER DISPLAY
REGISTER NUMBER:  T4:30.1
DIGITS RIGHT OF DECIMAL:  0
DIGITS LEFT OF DECIMAL:  3
LEAVE PLACE FOR SIGN (Y OR N):  N
SHOW LEADING ZEROS (Y OR N):  N
MINIMUM REGISTER VALUE:  0
MAXIMUM REGISTER VALUE:  500
MINIMUM DISPLAYED VALUE:  0
MAXIMUM DISPLAYED VALUE:  500
    
```

Arrows indicate changes

- Press [Esc] after entering the register data.

The data display window shows 3 asterisks (***) in row 1 indicating the data register position.

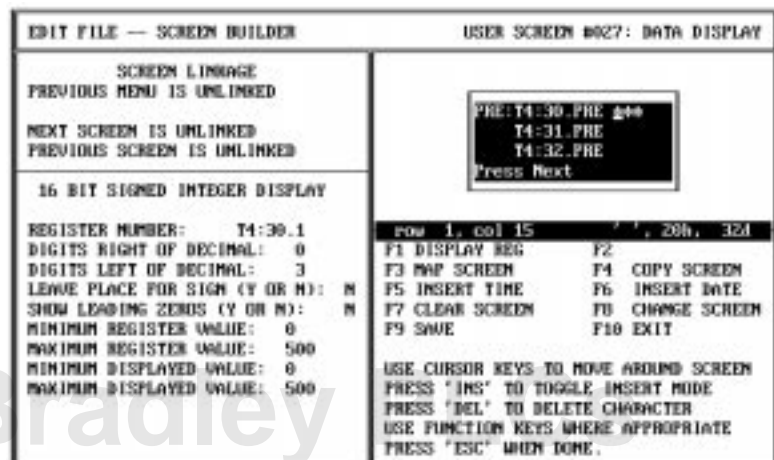

⇒ Steps 10 – 14 define the data register for line 2 of Screen 27.

10. Use the [↓] arrow key to move the cursor to row 2, column 15 of the display window.
11. Press [F1] (Display Register).

The screen displays a list of register types.

```

SELECT REGISTER TYPE:
BIT
16 BIT SIGNED INTEGER
16 BIT UNSIGNED INTEGER
16 BIT BCD
16 BIT HEX
32 BIT UNSIGNED INTEGER
32 BIT BCD
32 BIT HEX
ASCII
    
```

12. Highlight *16 Bit Signed Integer* and press [Return].

The *16 Bit Signed Integer Display* appears.

13. Use the arrow [↑↓] and [Return] keys to enter the following register data.

```

16 BIT SIGNED INTEGER DISPLAY
REGISTER NUMBER:  T4:31.1
DIGITS RIGHT OF DECIMAL:  0
DIGITS LEFT OF DECIMAL:  3
LEAVE PLACE FOR SIGN (Y OR N):  N
SHOW LEADING ZEROS (Y OR N):  N
MINIMUM REGISTER VALUE:  0
MAXIMUM REGISTER VALUE:  500
MINIMUM DISPLAYED VALUE:  0
MAXIMUM DISPLAYED VALUE:  500
    
```

Arrows indicate changes

14. Press [Esc] after entering the register data.

The data display window shows 3 asterisks (***) in row 2 indicating the data register position.

EDIT FILE -- SCREEN BUILDER	USER SCREEN #027: DATA DISPLAY
<p>SCREEN LANGUAGE PREVIOUS MENU IS UNLINKED</p> <p>NEXT SCREEN IS UNLINKED PREVIOUS SCREEN IS UNLINKED</p> <p>16 BIT SIGNED INTEGER DISPLAY</p> <p>REGISTER NUMBER: T4:31.1 DIGITS RIGHT OF DECIMAL: 0 DIGITS LEFT OF DECIMAL: 3 LEAVE PLACE FOR SIGN (Y OR N): N SHOW LEADING ZEROS (Y OR N): N MINIMUM REGISTER VALUE: 0 MAXIMUM REGISTER VALUE: 500 MINIMUM DISPLAYED VALUE: 0 MAXIMUM DISPLAYED VALUE: 500</p>	<div style="border: 1px solid black; padding: 5px; margin-bottom: 10px;"> <pre> PRE: T4:30.1 *** T4:31.1 *** T4:32.1 </pre> </div> <p>row 2, col 14 ' ', 200, 320</p> <p>F1 DISPLAY REG F2 F3 MAP SCREEN F4 COPY SCREEN F5 INSERT TIME F6 INSERT DATE F7 CLEAR SCREEN F8 CHANGE SCREEN F9 SAVE F10 EXIT</p> <p>USE CURSOR KEYS TO MOVE AROUND SCREEN PRESS 'INS' TO TOGGLE INSERT MODE PRESS 'DEL' TO DELETE CHARACTER USE FUNCTION KEYS WHERE APPROPRIATE PRESS 'ESC' WHEN DONE.</p>

⇒ Steps 15 – 19 define the data register for line 3 of Screen 27.

15. Use the [↓] arrow key to move the cursor to row 3, column 15 of the display window.
16. Press [F1] (Display Register).

The screen displays a list of register types.

```

SELECT REGISTER TYPE:
BIT
16 BIT SIGNED INTEGER
16 BIT UNSIGNED INTEGER
16 BIT BCD
16 BIT HEX
32 BIT UNSIGNED INTEGER
32 BIT BCD
32 BIT HEX
ASCII
    
```

17. Highlight *16 Bit Signed Integer* and press [Return].

The *16 Bit Signed Integer Display* appears.

18. Use the arrow [↑↓] and [Return] keys to enter the register data below.

```

16 BIT SIGNED INTEGER DISPLAY
REGISTER NUMBER:  T4:32.1
DIGITS RIGHT OF DECIMAL:  0
DIGITS LEFT OF DECIMAL:  3
LEAVE PLACE FOR SIGN (Y OR N):  N
SHOW LEADING ZEROS (Y OR N):  N
MINIMUM REGISTER VALUE:  0
MAXIMUM REGISTER VALUE:  500
MINIMUM DISPLAYED VALUE:  0
MAXIMUM DISPLAYED VALUE:  500
    
```

Arrows indicate changes

19. Press [Esc] after entering the register data.

The data display window shows 3 asterisks (***) in row 3 indicating the data register position.



Data Display (Screen 29)

1. Press the [F8] function key to start a new screen.

The screen prompts you for a new screen number.



2. Type **29** and press [Return].

The screen clears the previous screen and displays a list of screen types.



3. Highlight *Data Display Screen* and press [Return].
4. Enter the following data in the display window:

Type **NEW:T4:30.PRE** and press [Return]

Enter 4 spaces, type **T4:31.PRE**, press [Return]

Enter 4 spaces, type **T4:32.PRE**, press [Return]

Type **Press Next** and press [Return]

The screen should look like this.



Note: You will now enter 3 data registers for this screen.

⇒ Steps 5 – 9 define the data register for line 1 of Screen 29.

- Use the [↑↓][←→] arrow keys to move the cursor to row 1, column 15 of the display window.
- Press [F1] (Display Register).

The screen displays a list of register types.

```

SELECT REGISTER TYPE:
BIT
16 BIT SIGNED INTEGER
16 BIT UNSIGNED INTEGER
16 BIT BCD
16 BIT HEX
32 BIT UNSIGNED INTEGER
32 BIT BCD
32 BIT HEX
ASCII
    
```

- Highlight *16 Bit Signed Integer* and press [Return].

The *16 Bit Signed Integer Display* appears.

- Use the arrow [↑↓] and [Return] keys to enter the following register data.

```

16 BIT SIGNED INTEGER DISPLAY
REGISTER NUMBER:  T4:30.1
DIGITS RIGHT OF DECIMAL:  0
DIGITS LEFT OF DECIMAL:   3
LEAVE PLACE FOR SIGN (Y OR N):  N
SHOW LEADING ZEROS (Y OR N):  N
MINIMUM REGISTER VALUE:    0
MAXIMUM REGISTER VALUE:   500
MINIMUM DISPLAYED VALUE:  0
MAXIMUM DISPLAYED VALUE:  500
    
```

Arrows indicate changes

- Press [Esc] after entering the register data.

The data display window shows 3 asterisks (***) in row 1 indicating the data register position.



⇒ Steps 10 – 14 define the data register for line 2 of Screen 29.

10. Use the [↓] arrow key to move the cursor to row 2, column 15 of the display window.
11. Press [F1] (Display Register).
The screen displays a list of register types.

```

SELECT REGISTER TYPE:
BIT
16 BIT SIGNED INTEGER
16 BIT UNSIGNED INTEGER
16 BIT BCD
16 BIT HEX
32 BIT UNSIGNED INTEGER
32 BIT BCD
32 BIT HEX
ASCII
    
```

12. Highlight *16 Bit Signed Integer* and press [Return].
The *16 Bit Signed Integer Display* appears.
13. Use the arrow [↑↓] and [Return] keys to enter the following register data.

```

16 BIT SIGNED INTEGER DISPLAY
REGISTER NUMBER:  T4:31.1
DIGITS RIGHT OF DECIMAL:  0
DIGITS LEFT OF DECIMAL:  3
LEAVE PLACE FOR SIGN (Y OR N):  N
SHOW LEADING ZEROS (Y OR N):  N
MINIMUM REGISTER VALUE:  0
MAXIMUM REGISTER VALUE:  500
MINIMUM DISPLAYED VALUE:  0
MAXIMUM DISPLAYED VALUE:  500
    
```

Arrows indicate changes

14. Press [Esc] after entering the register data.
The data display window shows 3 asterisks (***) in row 2 indicating the data register position.

EDIT FILE -- SCREEN BUILDER	USER SCREEN #029: DATA DISPLAY										
<p>SCREEN LINKAGE PREVIOUS MENU IS UNLINKED</p> <p>NEXT SCREEN IS UNLINKED PREVIOUS SCREEN IS UNLINKED</p> <p>16 BIT SIGNED INTEGER DISPLAY</p> <p>REGISTER NUMBER: T4:31.1 DIGITS RIGHT OF DECIMAL: 0 DIGITS LEFT OF DECIMAL: 3 LEAVE PLACE FOR SIGN (Y OR N): N SHOW LEADING ZEROS (Y OR N): N MINIMUM REGISTER VALUE: 0 MAXIMUM REGISTER VALUE: 500 MINIMUM DISPLAYED VALUE: 0 MAXIMUM DISPLAYED VALUE: 500</p>	<div style="border: 1px solid black; padding: 5px; margin-bottom: 10px;"> <pre> MENU:T4:30.PRE *** T4:31.PRE *** T4:32.PRE Press Next </pre> </div> <p>row 2, col 15 ^ , 20h, 32d</p> <table style="width: 100%; border: none;"> <tr> <td>F1 DISPLAY REG</td> <td>F2</td> </tr> <tr> <td>F3 MAP SCREEN</td> <td>F4 COPY SCREEN</td> </tr> <tr> <td>F5 INSERT TIME</td> <td>F6 INSERT DATE</td> </tr> <tr> <td>F7 CLEAR SCREEN</td> <td>F8 CHANGE SCREEN</td> </tr> <tr> <td>F9 SAVE</td> <td>F10 EXIT</td> </tr> </table> <p>USE CURSOR KEYS TO MOVE AROUND SCREEN PRESS 'INS' TO TOGGLE INSERT MODE PRESS 'DEL' TO DELETE CHARACTER USE FUNCTION KEYS WHERE APPROPRIATE PRESS 'ESC' WHEN DONE.</p>	F1 DISPLAY REG	F2	F3 MAP SCREEN	F4 COPY SCREEN	F5 INSERT TIME	F6 INSERT DATE	F7 CLEAR SCREEN	F8 CHANGE SCREEN	F9 SAVE	F10 EXIT
F1 DISPLAY REG	F2										
F3 MAP SCREEN	F4 COPY SCREEN										
F5 INSERT TIME	F6 INSERT DATE										
F7 CLEAR SCREEN	F8 CHANGE SCREEN										
F9 SAVE	F10 EXIT										

☞ Steps 15 – 19 define the data register for line 3 of Screen 29.

15. Use the [↓] arrow key to move the cursor to row 3, column 15 of the display window.
16. Press [F1] (Display Register).

The screen displays a list of register types.

```
SELECT REGISTER TYPE:  
BIT  
16 BIT SIGNED INTEGER  
16 BIT UNSIGNED INTEGER  
16 BIT BCD  
16 BIT HEX  
32 BIT UNSIGNED INTEGER  
32 BIT BCD  
32 BIT HEX  
ASCII
```

17. Highlight *16 Bit Signed Integer* and press [Return].

The *16 Bit Signed Integer Display* appears.

18. Use the arrow [↑↓] and [Return] keys to enter the register data below.

```
16 BIT SIGNED INTEGER DISPLAY  
REGISTER NUMBER: 14:32.1  
DIGITS RIGHT OF DECIMAL: 0  
DIGITS LEFT OF DECIMAL: 3  
LEAVE PLACE FOR SIGN (Y OR N): N  
SHOW LEADING ZEROS (Y OR N): N  
MINIMUM REGISTER VALUE: 0  
MAXIMUM REGISTER VALUE: 500  
MINIMUM DISPLAYED VALUE: 0  
MAXIMUM DISPLAYED VALUE: 500
```

Arrows indicate changes

19. Press [Esc] after entering the register data.

The data display window shows 3 asterisks (***) in row 3 indicating the data register position.

Continue to the next section to create Data Entry 21.

Data Entry (Screen 21)

1. Press the [F8] function key to start a new screen.
The screen prompts you for a new screen number.



2. Type **21** and press [Return].

The screen clears the previous screen and displays a list of screen types.



3. Highlight *Data Entry Screen* and press [Return].
4. Enter the following data for Data Entry Screen 21:

Type **Enter Desired Temp** and press [Return]

Type **Actual:** (5 spaces) **Deg. C** and press [Return]

Type **Valid Range:140-170** and press [Return]

Type **Desired:** (4 spaces) and press [Return]

The screen should look like this.



Note: You will now enter 2 data registers for this screen.

⇒ Steps 5 – 9 define the data display register for line 2 of Screen 21.

- Use the [↑↓][←→] arrow keys to move the cursor to row 2, column 8 of the display window.
- Press [F1] (Display Register).

The screen displays a list of register types.

```
SELECT REGISTER TYPE:
BIT
16 BIT SIGNED INTEGER
16 BIT UNSIGNED INTEGER
16 BIT BCD
16 BIT HEX
32 BIT UNSIGNED INTEGER
32 BIT BCD
32 BIT HEX
ASCII
```

- Highlight *16 Bit Signed Integer* and press [Return].

The *16 Bit Signed Integer Display* appears.

- Use the arrow [↑↓] and [Return] keys to enter the following register data.

```
16 BIT SIGNED INTEGER DISPLAY
REGISTER NUMBER:  N7:20
DIGITS RIGHT OF DECIMAL:  0
DIGITS LEFT OF DECIMAL:  3
LEAVE PLACE FOR SIGN (Y OR N):  N
SHOW LEADING ZEROS (Y OR N):  N
MINIMUM REGISTER VALUE:  0
MAXIMUM REGISTER VALUE:  200
MINIMUM DISPLAYED VALUE:  0
MAXIMUM DISPLAYED VALUE:  200
```

Arrows indicate changes

- Press [Esc] after entering the register data.

The data display window shows 3 asterisks (***) in row 2 indicating the data display register position.

EDIT FILE — SCREEN BUILDER	USER SCREEN #021: DATA ENTRY										
<p>SCREEN LINKAGE PREVIOUS MENU IS UNLINKED</p> <p>NEXT SCREEN IS UNLINKED PREVIOUS SCREEN IS UNLINKED</p> <p>16 BIT SIGNED INTEGER DISPLAY</p> <p>REGISTER NUMBER: N7:20 DIGITS RIGHT OF DECIMAL: 0 DIGITS LEFT OF DECIMAL: 3 LEAVE PLACE FOR SIGN (Y OR N): N SHOW LEADING ZEROS (Y OR N): N MINIMUM REGISTER VALUE: 0 MAXIMUM REGISTER VALUE: 200 MINIMUM DISPLAYED VALUE: 0 MAXIMUM DISPLAYED VALUE: 200</p>	<div style="border: 1px solid black; padding: 5px; margin-bottom: 10px;"> <p>Enter Desired Temp Actual:*** Deg. C Valid Range:140-170 Desired:</p> </div> <p>row 2, col 8 *, 20h, 32d</p> <table border="0"> <tr> <td>F1 DISPLAY REG</td> <td>F2 ENTRY REG</td> </tr> <tr> <td>F3 MAP SCREEN</td> <td>F4 COPY SCREEN</td> </tr> <tr> <td>F5 INSERT TIME</td> <td>F6 INSERT DATE</td> </tr> <tr> <td>F7 CLEAR SCREEN</td> <td>F8 CHANGE SCREEN</td> </tr> <tr> <td>F9 SAVE</td> <td>F10 EXIT</td> </tr> </table> <p>USE CURSOR KEYS TO MOVE AROUND SCREEN PRESS 'INS' TO TOGGLE INSERT MODE PRESS 'DEL' TO DELETE CHARACTER USE FUNCTION KEYS WHERE APPROPRIATE PRESS 'ESC' WHEN DONE.</p>	F1 DISPLAY REG	F2 ENTRY REG	F3 MAP SCREEN	F4 COPY SCREEN	F5 INSERT TIME	F6 INSERT DATE	F7 CLEAR SCREEN	F8 CHANGE SCREEN	F9 SAVE	F10 EXIT
F1 DISPLAY REG	F2 ENTRY REG										
F3 MAP SCREEN	F4 COPY SCREEN										
F5 INSERT TIME	F6 INSERT DATE										
F7 CLEAR SCREEN	F8 CHANGE SCREEN										
F9 SAVE	F10 EXIT										

⇒ Steps 10 – 14 define the data entry register for line 4 of Screen 21.

10. Use the [↑↓][←→] arrow keys to move the cursor to row 4, column 9 of the display window.
11. Press [F2] (Entry Register).
The screen displays a list of data entry register types.



12. Highlight *16 Bit Signed Integer* and press [Return].
The *16 Bit Signed Integer Display* appears.

13. Use the arrow [↑↓] and [Return] keys to enter the following register data.

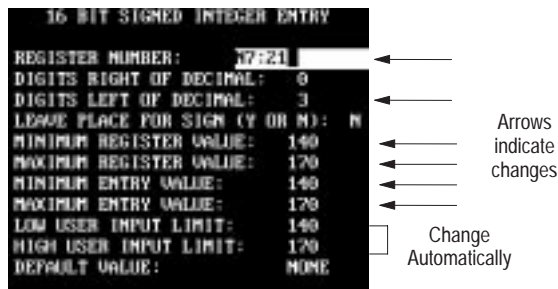

14. Press [Esc] after entering the register data.

The data display window shows 3 diamonds (◆◆◆) in row 4 indicating the data entry register position.

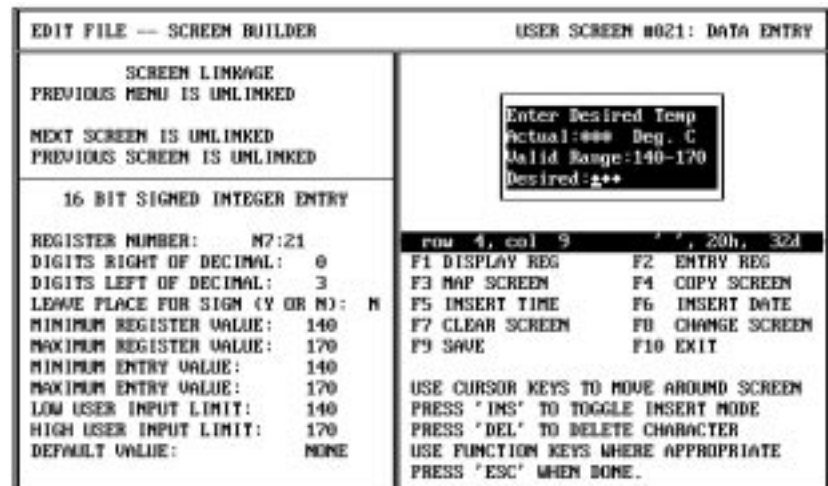

Continue to the next section to create Data Entry Screen 40.

Data Entry (Screen 40)

1. Press the [F8] function key to start a new screen.
The screen prompts you for a new screen number.



2. Type **40** and press [Return].

The screen clears the previous display and prompts you to enter a screen type.

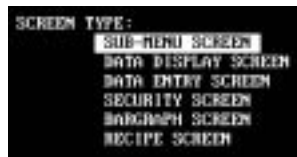

3. Highlight *Data Entry Screen* and press [Return].
4. Enter the following data in the display window:

Enter 4 spaces, type **Enter 60 to** and press [Return]

Enter 2 spaces, type **simulate an alarm** and press [Return]

Enter 4 spaces, type **Advisor: 0** and press [Return]

Enter 1 space, type **Data Entry:** and press [Return]

The screen should look like this.

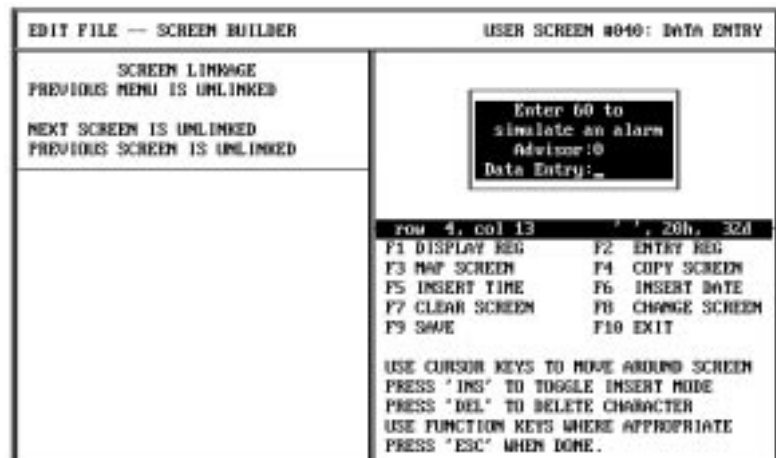

Note: You will now enter a data entry register for screen 40.

⇒ Steps 5 – 9 define the data entry register for line 4 of Screen 40.

- The cursor should be positioned at row 4, column 13 of the display window. If necessary, use the arrow keys to move the cursor.
- Press [F2] (Entry Register).
The screen displays a list of register types.



- Highlight *16 Bit Signed Integer* and press [Return].
The *16 Bit Signed Integer Display* appears.
- Use the arrow [↑↓] and [Return] keys to enter the following register data.

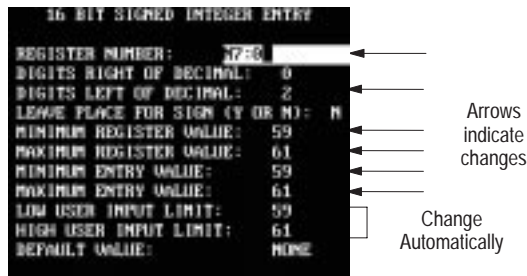

- Press [Esc] after entering the register data.
The data display window shows 2 diamonds (◆◆) in row 4 indicating the data entry register position.

EDIT FILE -- SCREEN BUILDER	USER SCREEN #040: DATA ENTRY										
<p>SCREEN LINKAGE PREVIOUS MENU IS UNLINKED</p> <p>NEXT SCREEN IS UNLINKED PREVIOUS SCREEN IS UNLINKED</p> <p>16 BIT SIGNED INTEGER ENTRY</p> <p>REGISTER NUMBER: N7:0 DIGITS RIGHT OF DECIMAL: 0 DIGITS LEFT OF DECIMAL: 2 LEAVE PLACE FOR SIGN (Y OR N): N MINIMUM REGISTER VALUE: 59 MAXIMUM REGISTER VALUE: 61 MINIMUM ENTRY VALUE: 59 MAXIMUM ENTRY VALUE: 61 LOW USER INPUT LIMIT: 59 HIGH USER INPUT LIMIT: 61 DEFAULT VALUE: NONE</p>	<div style="border: 1px solid black; padding: 5px; margin-bottom: 10px;"> <p>Enter 60 to simulate an alarm Advisor:0 Data Entry:◆◆</p> </div> <p>row 4, col 13 ' ', 20h, 32d</p> <table border="0"> <tr> <td>F1 DISPLAY REG</td> <td>F2 ENTRY REG</td> </tr> <tr> <td>F3 MAP SCREEN</td> <td>F4 COPY SCREEN</td> </tr> <tr> <td>F5 INSERT TIME</td> <td>F6 INSERT DATE</td> </tr> <tr> <td>F7 CLEAR SCREEN</td> <td>F8 CHANGE SCREEN</td> </tr> <tr> <td>F9 SAVE</td> <td>F10 EXIT</td> </tr> </table> <p>USE CURSOR KEYS TO MOVE AROUND SCREEN PRESS 'INS' TO TOGGLE INSERT MODE PRESS 'DEL' TO DELETE CHARACTER USE FUNCTION KEYS WHERE APPROPRIATE PRESS 'ESC' WHEN DONE.</p>	F1 DISPLAY REG	F2 ENTRY REG	F3 MAP SCREEN	F4 COPY SCREEN	F5 INSERT TIME	F6 INSERT DATE	F7 CLEAR SCREEN	F8 CHANGE SCREEN	F9 SAVE	F10 EXIT
F1 DISPLAY REG	F2 ENTRY REG										
F3 MAP SCREEN	F4 COPY SCREEN										
F5 INSERT TIME	F6 INSERT DATE										
F7 CLEAR SCREEN	F8 CHANGE SCREEN										
F9 SAVE	F10 EXIT										

Continue to the next section to create the Security Screen.

Security Screen (39)

1. Press [F8] to start a new screen.

The screen prompts you for a new screen number.

2. Type **39** and press [Return].

You are prompted for a screen type.

3. Highlight *Security Screen* and press [Return].

This screen appears.



4. Enter the following access codes in the *Security Codes* window.

Code 1 = **1234** [Return]

Code 2 = **5678** [Return]

Code 3 = **1992** [Return]

5. Press [Esc] to accept the codes.

The screen should look like this. No other changes are required. The application will use the default text in the window.

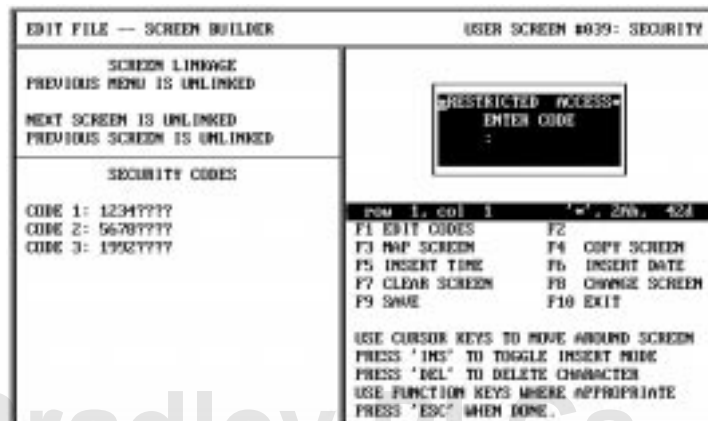

Continue to the next section to create a Bar Graph screen.

Bar Graph Screen (11)

1. Press [F8] to start a new screen.
The screen prompts you for a screen number.



2. Type **11** and press [Return].
You are prompted to enter a screen type.



3. Highlight *BarGraph Screen* and press [Return].
The screen prompts you for a register type.



4. Press [Return] to select *16 Bit Signed Integer*.
The screen now looks like this.

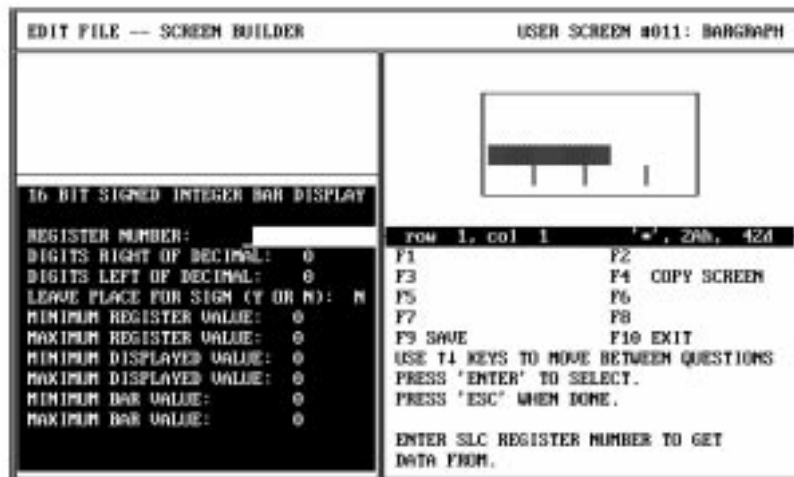

5. Use the arrow [$\uparrow\downarrow$] and [Return] keys to enter the following register data.

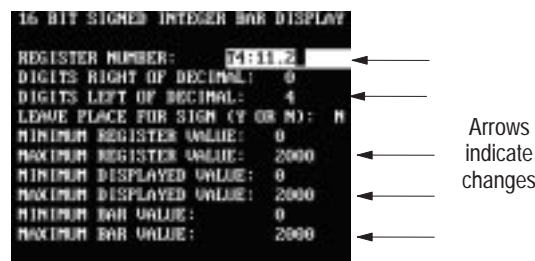

6. Press [Esc] after entering the register data.
Notice how the values have been applied to the bar graph.

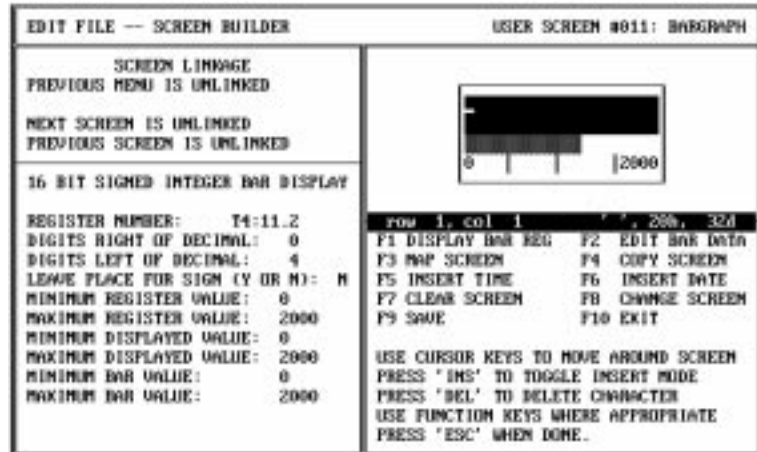

7. Enter the following text in the display window:
Type **East Main Pump Speed**.
Enter 5 spaces, type **RPM** and press [Return]
With the entered text, the display window looks like this.

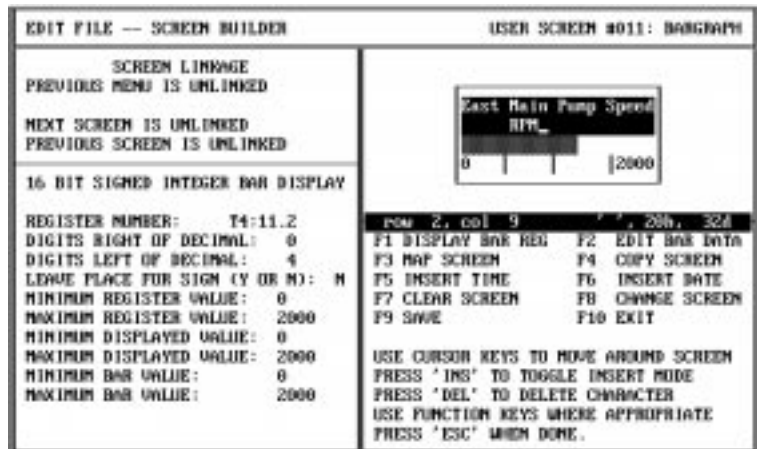

8. Position the cursor at row 2, column 1 (5 spaces to the left of RPM).
9. Press [F1] (Display Bar Register).
You should see 4 asterisks (****) before RPM indicating a data register.

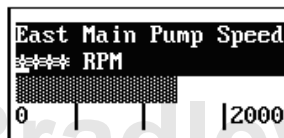

Recipe Screen (28)

1. Press [F8] to start a new screen.
The screen prompts you for a new screen number.
2. Type **28** and press [Return].
The screen clears the bar graph and prompts you to select a screen type.



3. Highlight *Recipe Screen* and press [Return].
You are asked if the operator should be prompted to download the recipe data.

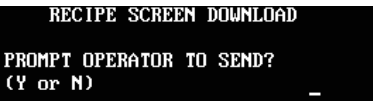

4. Enter **Y** and press [Return].
You are asked to select a register type.



5. Press [Return] to select *16 Bit Signed Integer*.
You are prompted to enter register data.

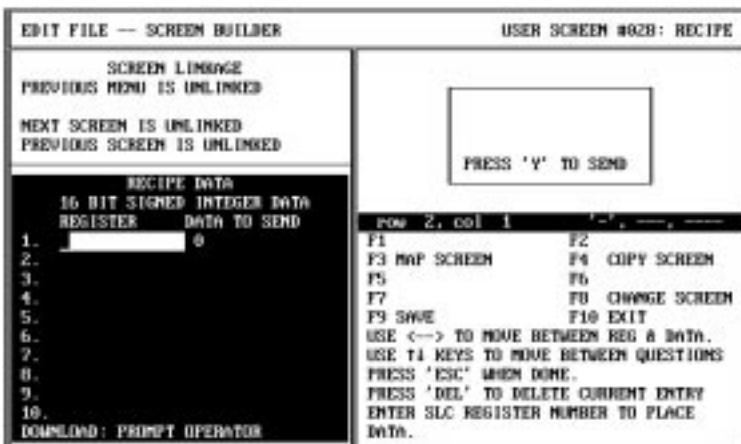

☞ *PRE* automatically changes to 1 after pressing [Return].

- Enter the following 3 rows of recipe data.

T4:30.PRE [Return] **5** [Return]

T4:31.PRE [Return] **15** [Return]

T4:32.PRE [Return] **25** [Return]

The *Recipe Data* should look like this.

```

RECIPE DATA
16 BIT SIGNED INTEGER DATA
REGISTER      DATA TO SEND
1.  T4:30.1    5
2.  T4:31.1   15
3.  T4:32.1   25
4.  _____
5.
6.
7.
8.
9.
10.
DOWNLOAD: PROMPT OPERATOR
    
```

- Press [Esc] to accept the data.

You are now prompted to enter text in the highlighted display window.

- Enter the following text:

**Download Batch Times
for Chocolate Chip** [Return]

The screen should look like this.

```

EDIT FILE -- SCREEN BUILDER                                USER SCREEN #028: RECIPE
-----
SCREEN LINKAGE
PREVIOUS MENU IS UNLINKED
NEXT SCREEN IS UNLINKED
PREVIOUS SCREEN IS UNLINKED

RECIPE DATA
16 BIT SIGNED INTEGER DATA
REGISTER      DATA TO SEND
1.  T4:30.1    5
2.  T4:31.1   15
3.  T4:32.1   25
4.
5.
6.
7.
8.
9.
10.
DOWNLOAD: PROMPT OPERATOR

Download Batch Times
for Chocolate Chip
PRESS 'Y' TO SEND

row 2, col 19          ' ', 200, 324
F1 EDIT DATA          F2 AUTO-PROMPT
F3 MAP SCREEN          F4 COPY SCREEN
F5 INSERT TIME         F6 INSERT DATE
F7 CLEAR SCREEN        F8 CHANGE SCREEN
F9 SAVE                F10 EXIT

USE CURSOR KEYS TO MOVE AROUND SCREEN
PRESS 'INS' TO TOGGLE INSERT MODE
PRESS 'DEL' TO DELETE CHARACTER
USE FUNCTION KEYS WHERE APPROPRIATE
PRESS 'ESC' WHEN DONE.
    
```

Continue to the next section to link the screens you have created.

Linking Application Screens

This section shows how to link all the screens you have created.

Main Menu Links

In this section, you will link screens 11, 20, 39 and 40 to the Main Menu.

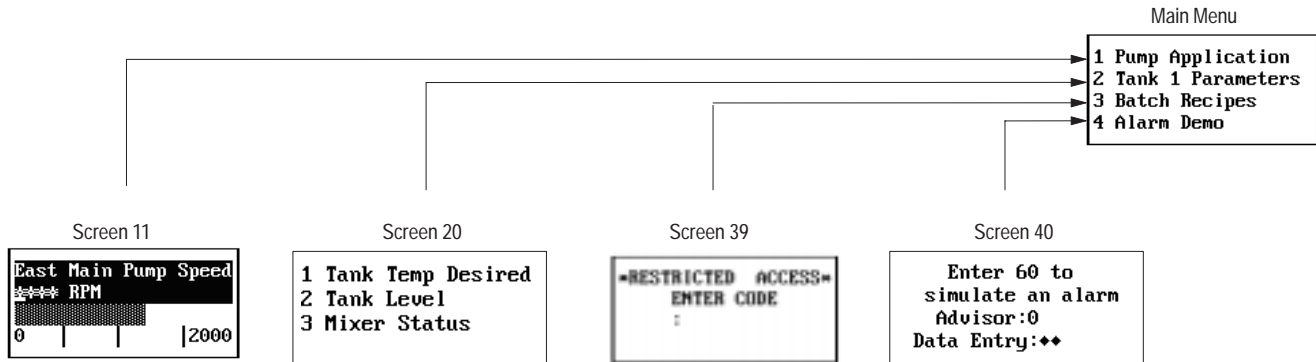

1. Press [F8].
You are prompted for a screen number.
2. Type **1** and press [Return].
The *Main Menu* appears.
3. Press [F3] to link screens 11, 20, 39 and 40 to the Main Menu.
The *Menu Item Linkage Display* appears.
4. Enter the following screen links. Press [Return] after each entry.

```
MENU ITEM LINKAGE
ITEM 1 IS LINKED TO SCREEN 011
ITEM 2 IS LINKED TO SCREEN 020
ITEM 3 IS LINKED TO SCREEN 039
ITEM 4 IS LINKED TO SCREEN 040
ITEM 5 IS LINKED TO SCREEN 0
ITEM 6 IS UNLINKED
ITEM 7 IS UNLINKED
ITEM 8 IS UNLINKED
```

5. Press [Esc] to save the links.

Sub-Menu Links

In this section, you will link screens 21, 22 and 23 to the Sub-Menu.

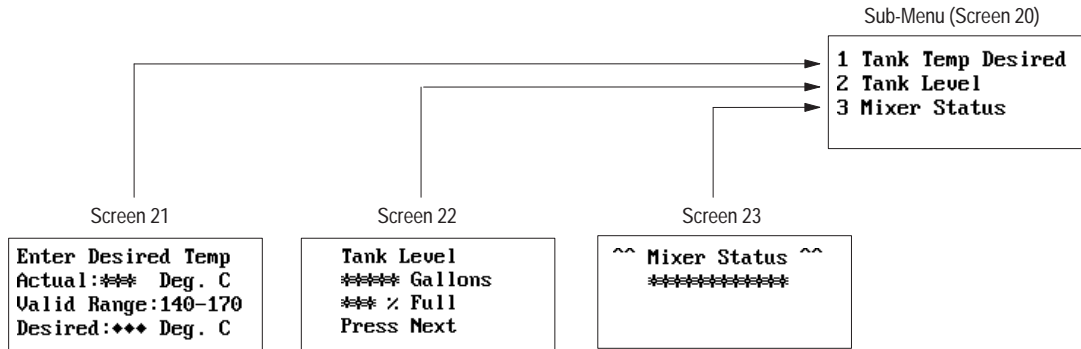

1. Press [F8].
You are prompted for a screen number.
2. Type **20** and press [Return].
The *Sub-Menu* screen appears.
3. Press [F3] to link screens 21, 22, and 23 to the Sub-Menu.
4. Enter the screen links as follows.

```

MENU ITEM LINKAGE
ITEM 1 IS LINKED TO SCREEN 021
ITEM 2 IS LINKED TO SCREEN 022
ITEM 3 IS LINKED TO SCREEN 023
ITEM 4 IS LINKED TO SCREEN  █
ITEM 5 IS UNLINKED
ITEM 6 IS UNLINKED
ITEM 7 IS UNLINKED
ITEM 8 IS UNLINKED
  
```

5. Press [Esc] to save the links.

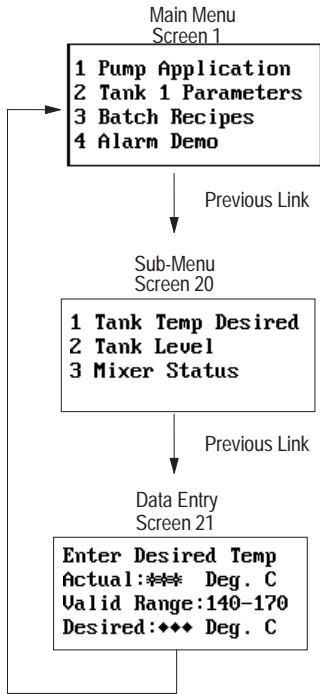

Link Screen 21 Back to Main Menu

1. Press [F8].
You are prompted for a screen number.
2. Type **21** and press [Return].
Data Entry Screen 21 appears.
3. Press [F3].
4. Press [F3] (Insert GoTo) again.
You are asked to insert a goto link.
5. Enter **1** and press [Return].

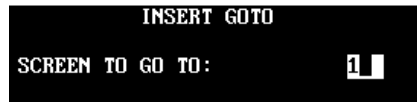

The *Screen Linkage* display confirms that Screen 21 returns to Screen 1.

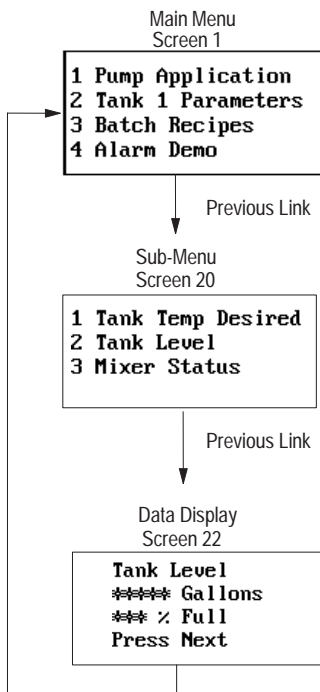

Link Screen 22 Back to Main Menu

1. Press [F8].
You are prompted for a screen number.
2. Type **22** and press [Return].
Data Display Screen 22 appears.
3. Press [F3].
4. Press [F3] (Insert GoTo) again.
You are asked to insert a goto link.
5. Enter **1** and press [Return].

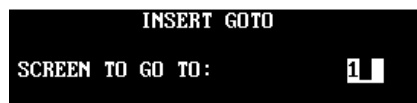

The *Screen Linkage* display confirms that Screen 22 returns to Screen 1.

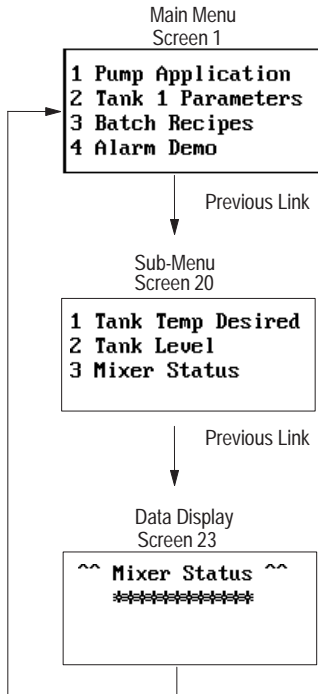

Linking Screen 23 Back to Main Menu

1. Press [F8].
You are prompted for a screen number.
2. Type **23** and press [Return].
Data Display Screen 23 appears.
3. Press [F3].
4. Press [F3] (Insert GoTo).
You are asked to insert a goto link.
5. Enter **1** and press [Return].

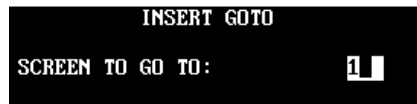

The *Screen Linkage* display confirms that Screen 23 returns to Screen 1.

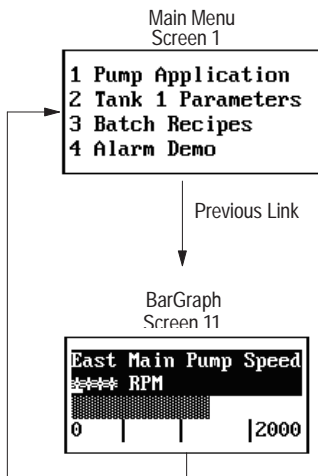

Linking Screen 11 Back to Main Menu

1. Press [F8].
You are prompted for a screen number.
2. Type **11** and press [Return].
BarGraph Screen 11 appears.
3. Press [F3].
4. Press [F3] (Insert GoTo).
You are asked to insert a goto link.
5. Enter **1** and press [Return].

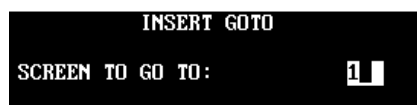

The *Screen Linkage* display confirms that Screen 11 returns to Screen 1.

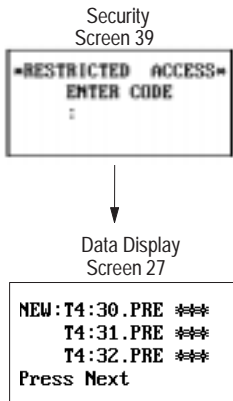

Link Screen 39 to Screen 27

1. Press [F8].
You are prompted for a screen number.
2. Type **39** and press [Return].
Security Screen 39 appears.
3. Press [F3].
4. Press [F3] (Insert GoTo).
You are asked to insert a goto link.

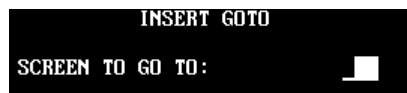

5. Enter **27** and press [Return].
The *Screen Linkage* display confirms that Screen 39 goes to Screen 27.

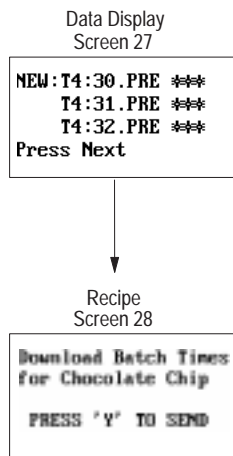

Link Screen 27 to Screen 28

1. Press [F8].
You are prompted for a screen number.
2. Type **27** and press [Return].
Data Display Screen 27 appears.
3. Press [F3].
4. Press [F3] (Insert GoTo).
You are asked to insert a goto link.

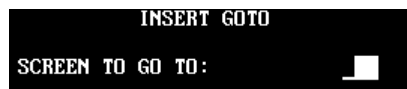

5. Enter **28** and press [Return].
The *Screen Linkage* display confirms that Screen 27 goes to Screen 28.

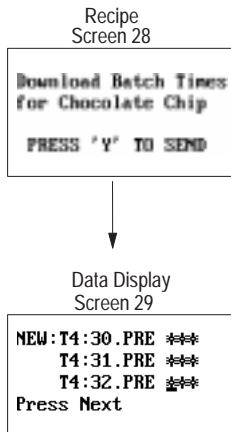

Link Screen 28 to Screen 29

1. Press [F8].
You are prompted for a screen number.
2. Type **28** and press [Return].
Recipe Screen 28 appears.
3. Press [F3].
4. Press [F3] (Insert GoTo).
You are asked to insert a goto link.

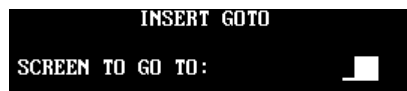

5. Enter **29** and press [Return].
The *Screen Linkage* display confirms that Screen 28 goes to Screen 29.

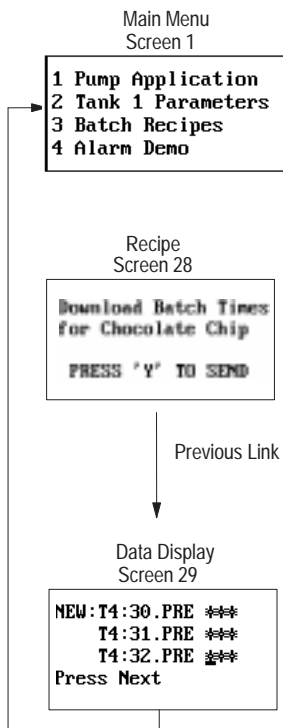

Link Screen 29 Back to Main Menu

1. Press [F8].
You are prompted for a screen number.
2. Type **29** and press [Return].
Data Display Screen 29 appears.
3. Press [F3].
4. Press [F3] (Insert GoTo).
You are asked to insert a goto link.

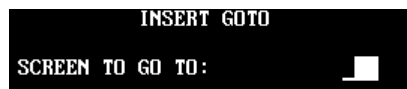

5. Enter **1** and press [Return].
The *Screen Linkage* display confirms that Screen 29 goes to Screen 1.

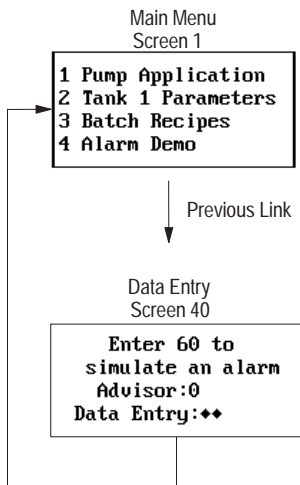

Link Screen 40 Back to Main Menu

1. Press [F8].
You are prompted for a screen number.
2. Type **40** and press [Return].
Data Entry screen 40 appears.
3. Press [F3].
4. Press [F3] (Insert GoTo).
You are asked to insert a goto link.

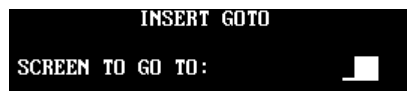

5. Enter **1** and press [Return].
The *Screen Linkage* display confirms that Screen 40 goes to Screen 1.

Creating Alarm Screen

The section shows how to create an *Alarm Screen* for the application.

1. Press [Esc] to return to the *Edit File* menu.

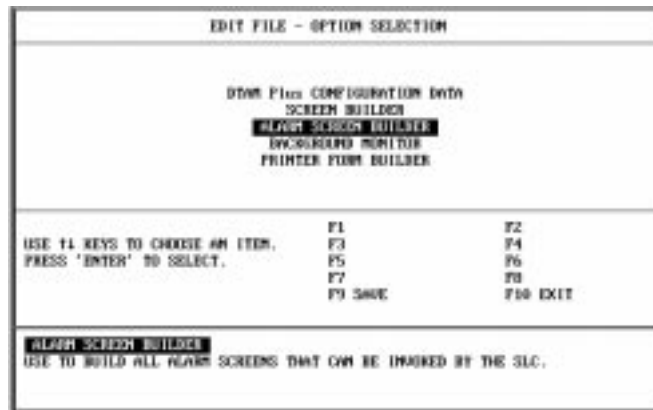

2. Select *Alarm Screen Builder*.

You are prompted to enter a number for the first alarm screen.



3. Enter **60** and press [Return].

You are now prompted to enter text in the highlighted display window.

☞ *Function key [F5] inserts time and [F6] inserts date.*

4. Enter the following text, time, and date:

Type **Mixer OL is Tripped** and press [Return]

Press [F5], enter 5 spaces, press [F6], press [Return]

The last line of text *Press "Y" to Clear* cannot be changed. The screen should look like this.

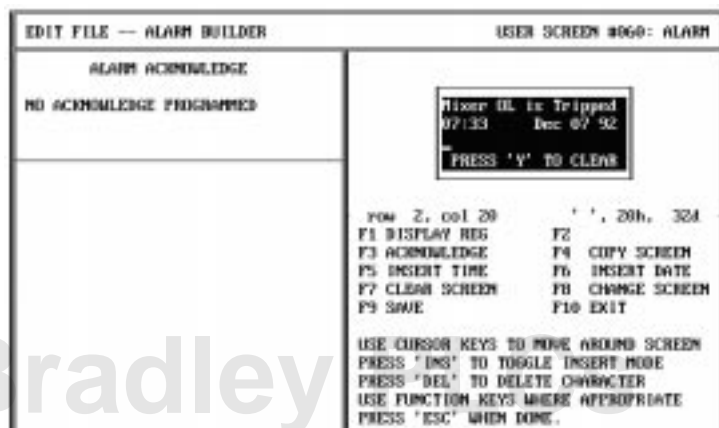

Creating Alarm Screen

5. Press the [F3] key (Acknowledge).

The *Alarm Acknowledge Register* window appears.

```
ALARM ACKNOWLEDGE REGISTER
REGISTER NUMBER: 
BIT NUMBER: 
SEND 1 OR 0:      0
```

6. Use the arrow [\uparrow / \downarrow] and [Return] keys to enter the following data.

```
ALARM ACKNOWLEDGE REGISTER
REGISTER NUMBER:  7:1 
BIT NUMBER:      1
SEND 1 OR 0:      0
```

7. Press [Esc] after entering the data.

The *Alarm Acknowledge* window confirms the register data you just entered.

Continue to the next section to edit the Background Monitor.

Edit Background Monitor

```
DTM Plus CONFIGURATION DATA
SCREEN BUILDER
ALARM SCREEN BUILDER
BACKGROUND MONITOR
PRINTER FORM BUILDER
```

You will now enter the *Background Monitor* to assign the alarm screen to a bit that monitors alarm conditions. When this bit is set (turns ON), Alarm Screen 60 will appear.

1. Press [Esc] to return to the *Edit File* menu.
2. Highlight *Background Monitor* and press [Return].

The *Background Builder* screen appears.

3. Press [Return] to select *Background Register 1*.

The following screen appears.

```
FILE NAME: BEND.CFG                                BACKGROUND REGISTER # 1

          BIT
          16 BIT SIGNED INTEGER
          16 BIT BCD

SELECT BACKGROUND REGISTER TYPE      F1          F2
                                      F3          F4
                                      F5          F6
USE 14 KEYS TO CHOOSE AN ITEM.      F7          F8 NEXT REGISTER
PRESS 'ENTER' TO SELECT.            F9          F10 EXIT

          BIT
USE THIS TYPE OF BACKGROUND REGISTER TO MONITOR EACH BIT IN THE
REGISTER FOR AN ALARM CONDITION. THERE CAN BE 1 BACKGROUND SCREEN
FOR EACH BIT IN THE REGISTER.
```

4. Press [Return] to select *Bit*.

You are prompted to enter *Monitor Bit Register* data.

```
EDIT FILE -- BACKGROUND BUILDER                    BACKGROUND REG #1: BIT

MONITOR BIT REGISTER
REGISTER NUMBER: 0
BIT NUMBER: 0
ALARM STATE: ON (1)
SCREEN NUMBER:

F1 SHOW NEXT ALARM  F2 NEXT FORM #
F3 DELETE SCREEN #  F4 NEXT BIT
F5 PREVIOUS BIT     F6 NEXT BIT
F7 DELETE REG       F8 NEXT REGISTER
F9 SAVE             F10 EXIT
USE 14 KEYS TO MOVE BETWEEN QUESTIONS
ANSWER QUESTION AND PRESS 'ENTER'.

ENTER SLC REGISTER NUMBER TO MONITOR.
```

5. Enter the following data in the *Monitor Bit Register* window.

```
MONITOR BIT REGISTER
REGISTER NUMBER: 0310
BIT NUMBER: 1
ALARM STATE: ON (1)
SCREEN NUMBER: 60
```

← Enter 1 Here

After entering 60 and pressing [Return], the *Alarm Screen* appears in the display window.

Edit Background Monitor

6. Press [Esc] to accept the data.
You return to the *Background Builder* screen.
7. Press [Esc] to return to the *Edit File* menu.



You are now finished entering the sample application.

Saving the Application File

You now need to save the application and return to DOS.

1. Press [Esc] to save the application and exit the software.
The screen displays the file name and path for the save operation.



2. Press [Return] to save the application to C:\DPS\DEMO.CFG.

You are returned to the *Edit File* menu.

3. Press [Esc].
You are asked if you want to exit to DOS.

4. Enter **Y**.
C:\DPS>

Now that you have entered and saved your application, you can download the application to your DTAM Plus terminal. The next chapter shows how to download an application.

Downloading the Application

Chapter Objectives

This chapter describes how to download the sample application from your computer to the DTAM Plus. It tells how to:

- Set DTAM Plus DIP switches
- Connect power and communication cables
- Download the application

Download DIP Switch Settings

Before you can download an application, you must set the DTAM Plus DIP switches as shown in Figure 6.1.

To access DIP switches, remove the plug from the access hole on the back of the DTAM Plus.

Figure 6.1
DIP Switch Settings for Download

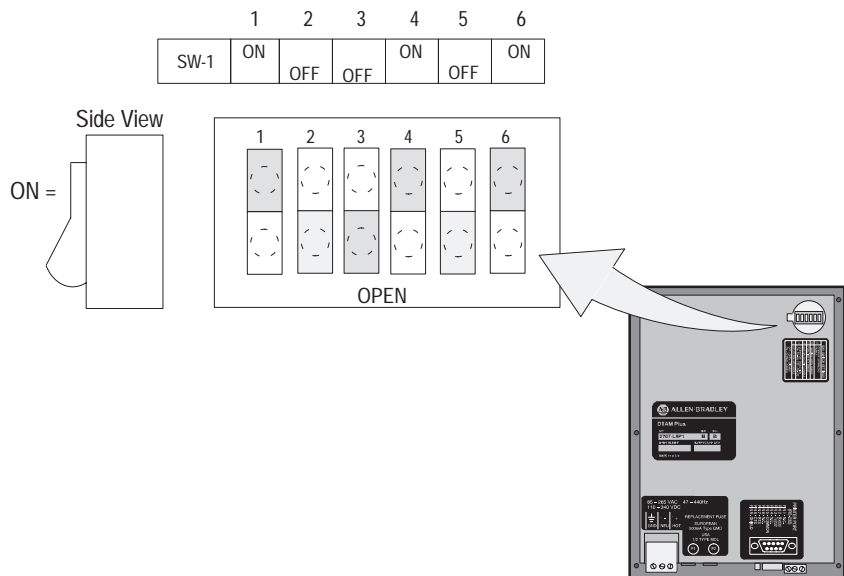

Download Connections

To download an application file to the DTAM Plus, you must:

- connect a power cord
- connect the upload/download cable (Catalog No. 2707-NC2)

Figure 6.2 shows these connections.

Figure 6.2
Power and Download Connections

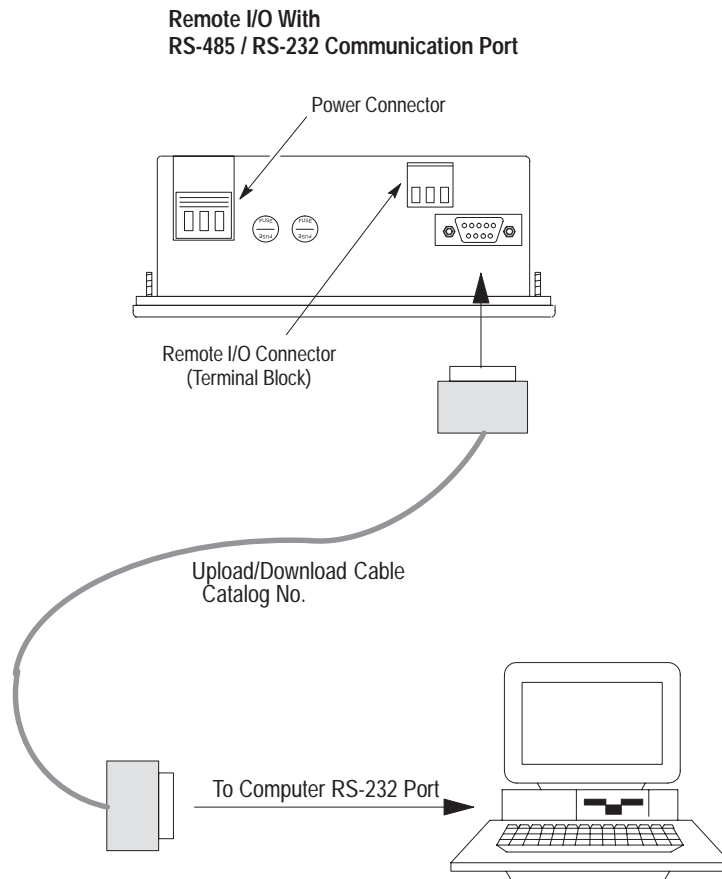

Downloading the Application

This section shows how to download the sample application from your computer to the DTAM Plus.

1. Apply power to the DTAM Plus.

The following message appears in the window of the DTAM Plus.

```
Programming Mode
Waiting For Program
Upload / Download
```

If you do not see this message, check the DIP switch settings. DIP Switch 1 must be in the Closed (ON) position.

2. Move to the /DPS subdirectory where the software resides.

```
C:\DPS>
```

3. Type **dps** and press [Return] to start the program.

```
C:\DPS>dps [Return]
```

4. Specify whether you are using a color monitor. Enter **Y** or **N**.

5. The startup screen displays. It identifies the DPS version and licensed owner. A phone support number is provided for your assistance.

 You will not see this prompt if a monitor was specified during installation.



Downloading the Application

- Press any key (other than [Esc]) to continue.

The *Opening Menu* appears.

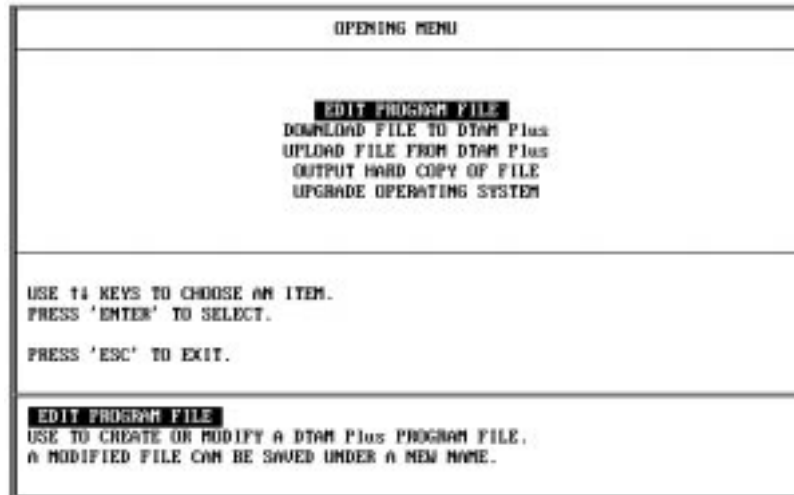

- Highlight *Download File to DTAM Plus* and press [Return].

The *Communication Port Selection* screen appears.

☞ This screen will not appear if you selected a communication port during installation.

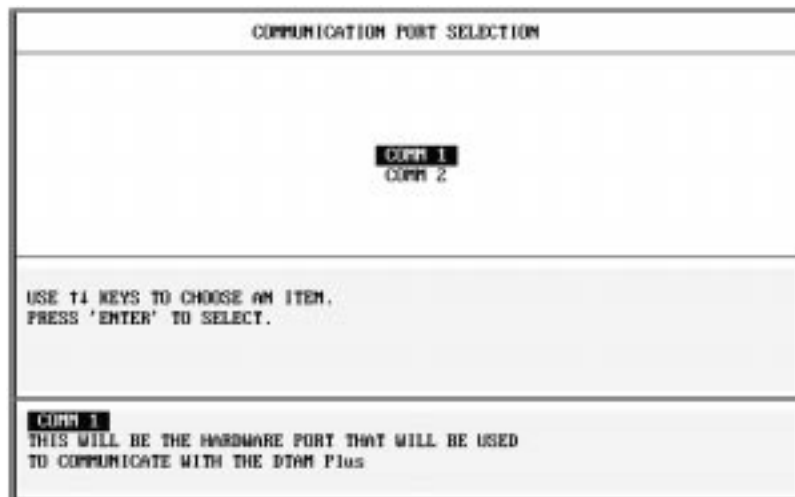

- Highlight the serial port on your computer that is connected to the DTAM Plus (COMM 1 or COMM 2) and press [Return].

☞ If a communication link does not occur in 10 seconds, you get an error message. Check DIP switch settings and cable connections.

- When communication is established, the following screen appears with the name of the sample application file, DEMO.

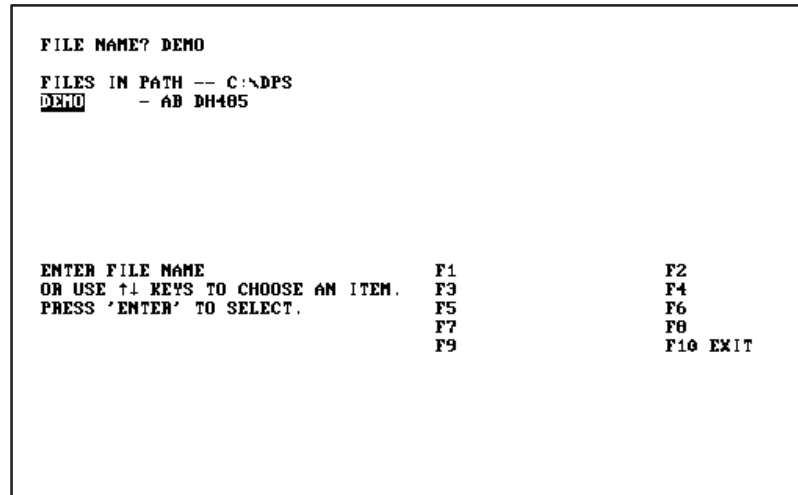

- Press [Return] to load DEMO.

If the Operating System of the file (DH-485) is different from the existing Operating System in the DTAM Plus, you are asked to download a new Operating System. If this happens, enter Y.

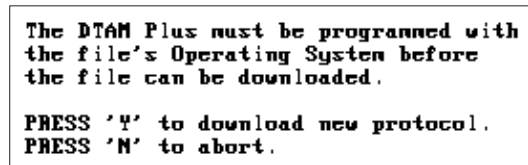

- The download begins and the following screen shows the progress of the download operation.

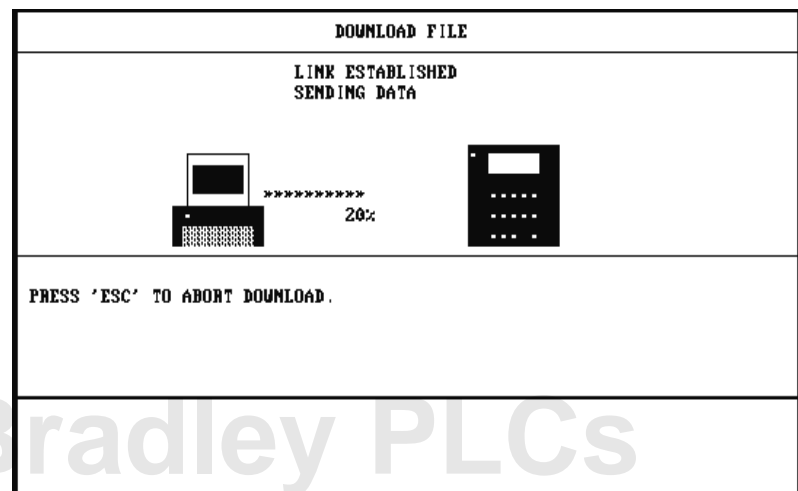

Downloading the Application

12. When the download is complete, you are returned to the *Opening Menu*.

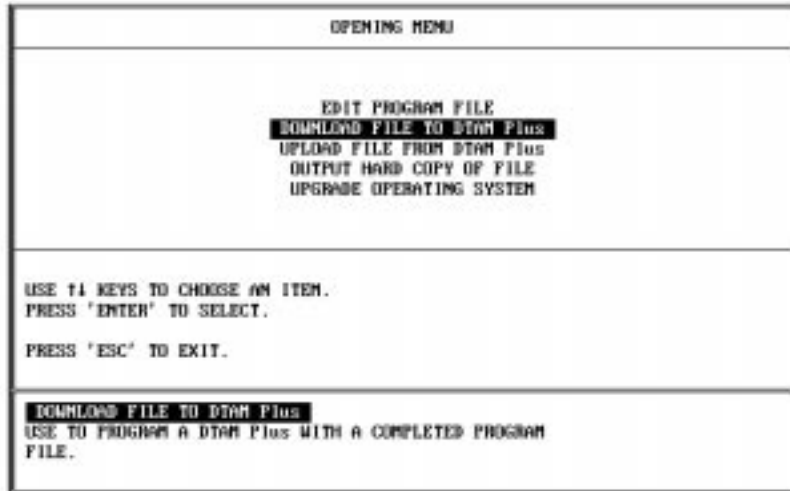

13. Press [Esc] to exit the software.

14. Press [Y] to return to DOS.

You are now ready to run the application. Move on to the next chapter.

SLC Application File

Chapter Objectives

This chapter provides the ladder logic program required to run the DTAM Plus sample application.

Configuring the SLC 500

You can program an SLC 500 using either of the following:

- Advanced Programming Software (APS) on a personal computer
- Hand-Held Terminal

This manual does not provide instructions on how to program the SLC controller. Refer to the User Manuals for the equipment you are using. Included in this chapter is the logic program you need to enter.

Preloaded Values

To provide values for the sample program, the data below must be loaded into the following SLC data files.

Address	0	1	2	3	4	5	6	7	8	9
N10:0	0	30	77	122	144	179	222	245	259	278
N10:10	301	322	367	378	399	488	512	533	542	588
N10:20	601	544	566	567	533	521	524	500	433	333
N10:30	288	266	211	197	155	140	98	55	11	0
N10:40	0	3	8	12	14	18	22	25	26	28
N10:50	30	32	37	38	40	49	51	53	54	59
N10:60	60	54	57	57	53	52	52	50	43	33
N10:70	29	27	21	20	16	14	10	6	1	0
N10:80	0	0	1	1	5	5	5	5	1	5
N10:90	5	1	1	5	5	4	4	0	5	5
N10:100	4	5	0	4	5	5	5	4	0	0
N10:110	0	0	0	0	0	0	0	0	0	0
N10:120	0									

Ladder Logic Program

Rung 2:0

Reset the DTAM Plus Advisor registers during the first scan of the SLC 500.

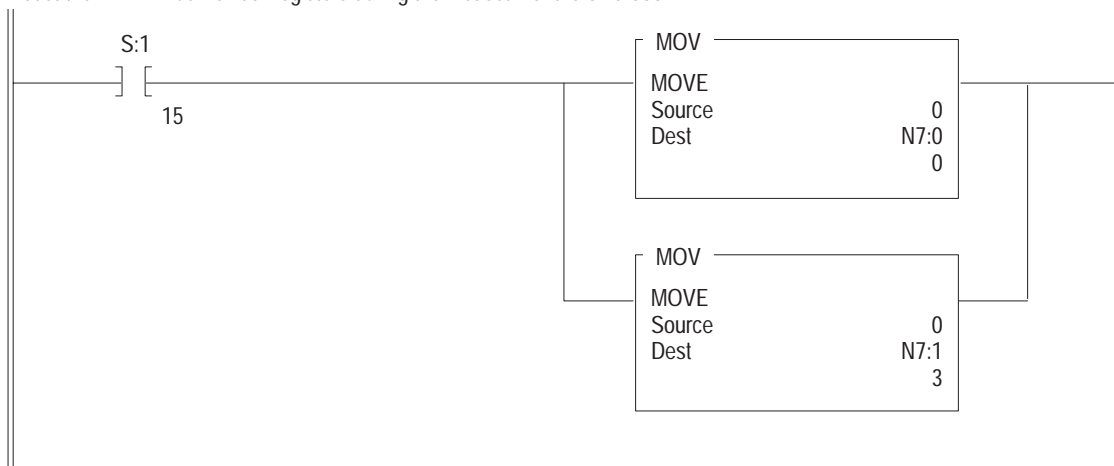

Rung 2:1

This timer drives the SQO instructions once per second.

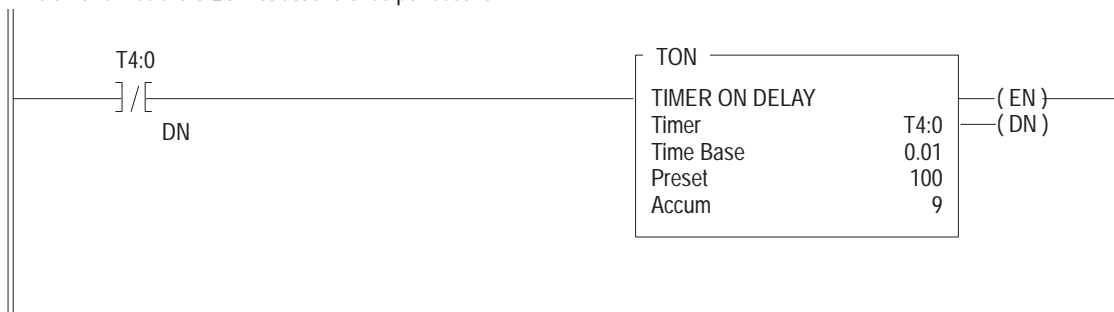

Rung 2:2

This sequencer simulates the gallons value for screen #22 (TANK LEVEL) in the DTAM Plus. There are 40 decimal values pre-loaded into #N10:0

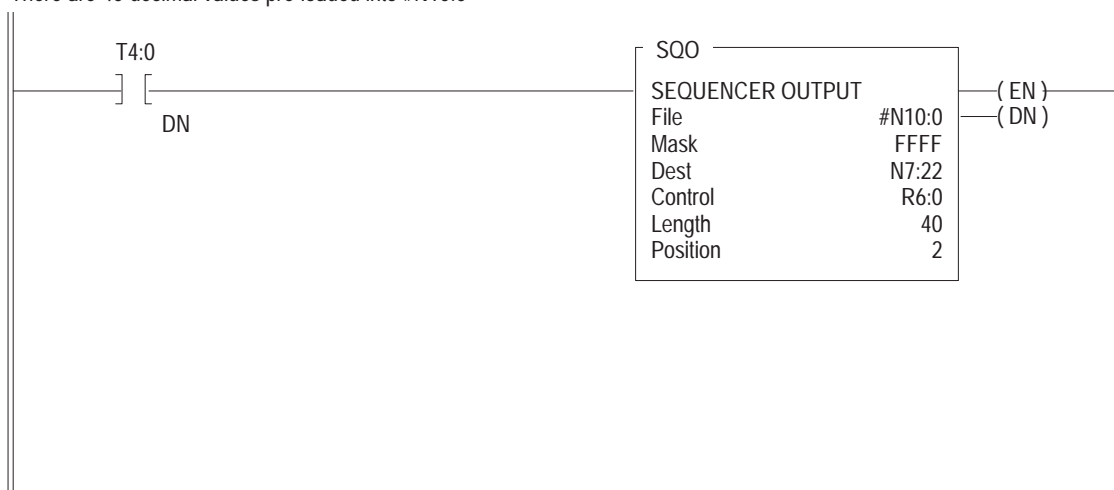

Rung 2:3

This sequencer provides the data to simulate the %FULL of the tank (Screen #22).
There are 40 decimal values preloaded into #N10:40

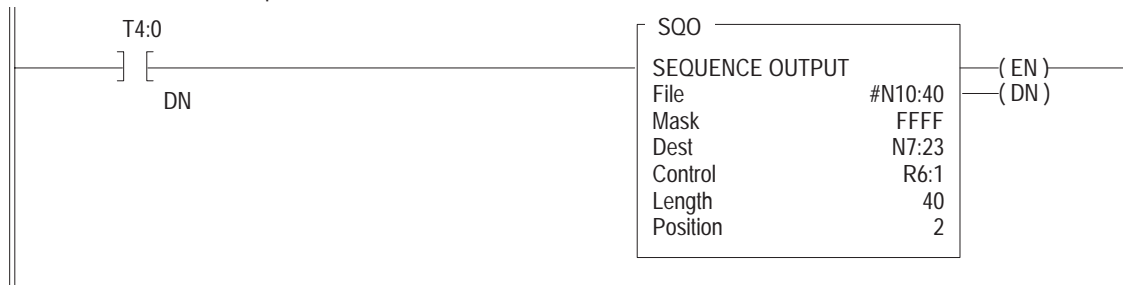

Rung 2:4

This rung simulates the temp preset value for screen #21. The operator keys in the desired temp ranging from 140 to 170. The DTAM Plus writes this value directly to N7:21. This rung then moves the entered value to N7:20 (Data Display Register). The data display register simulates the actual temp.

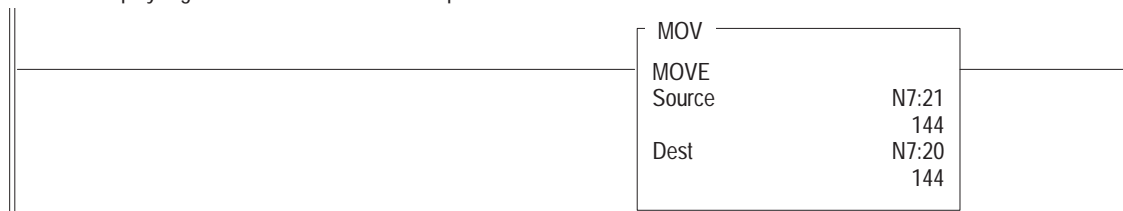

Rung 2:5

This SGO provides the bit values that simulate the Mixer (Screen #23)

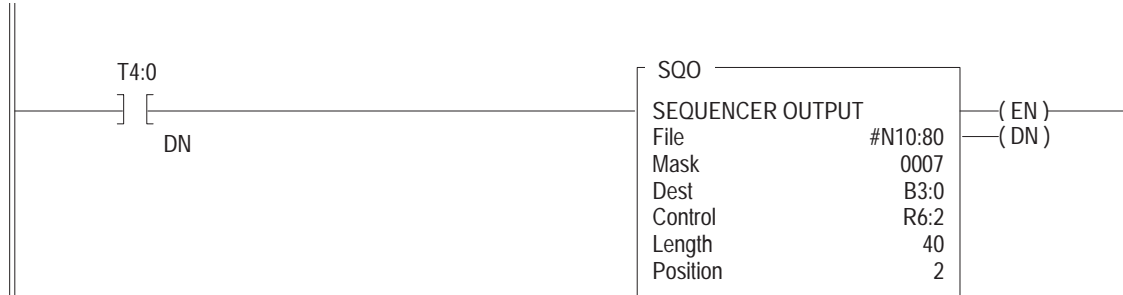

Rung 2:6

Free running timer provides variable data for Bar Graph screen #11.

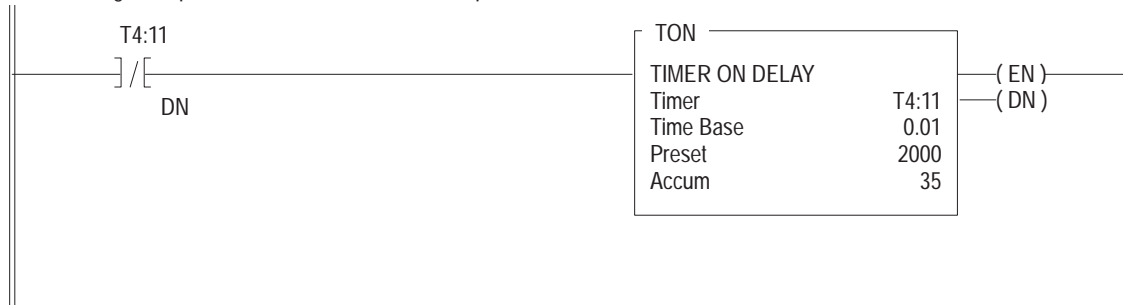

Ladder Logic Program

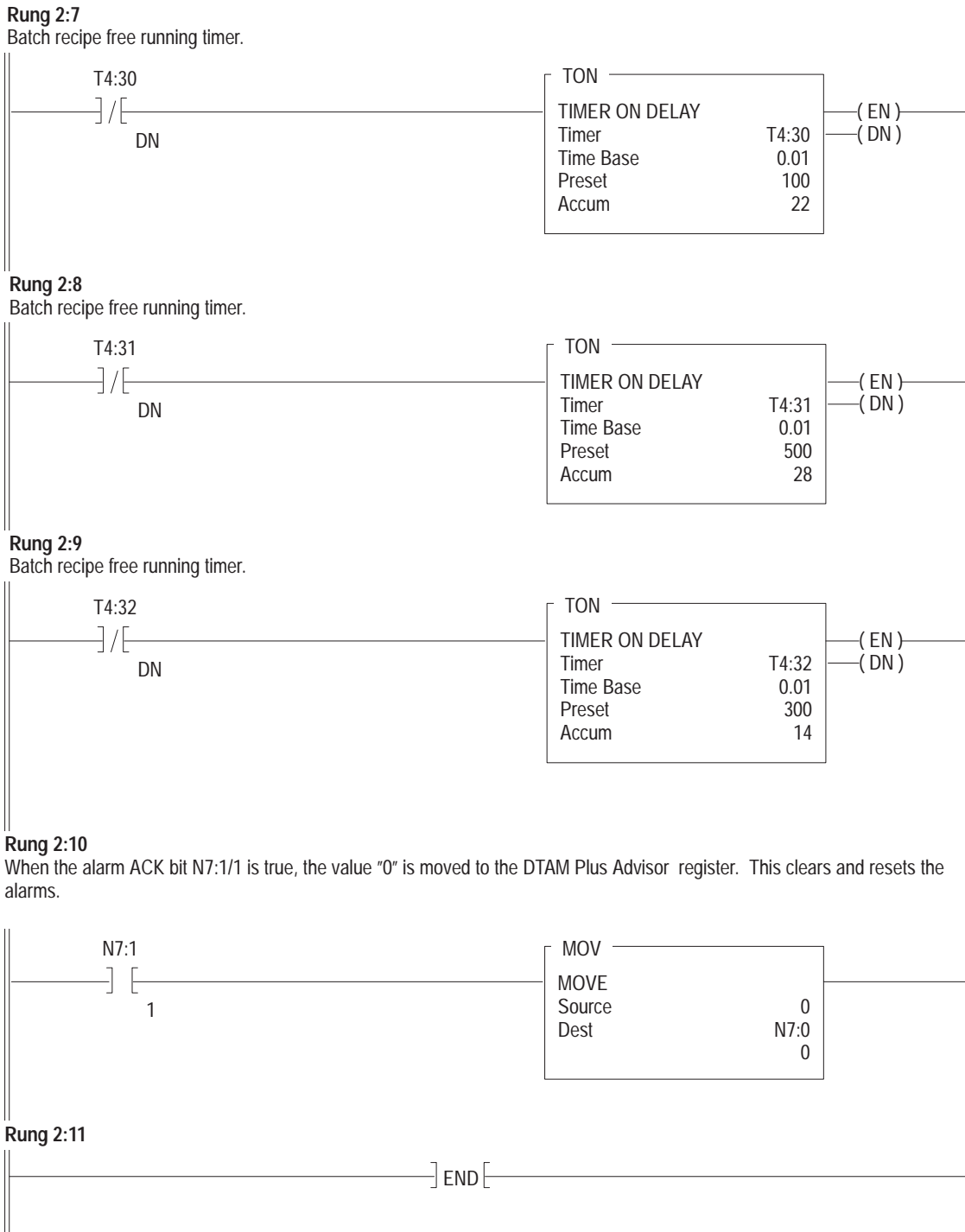

Running the Application

Chapter Objectives

This chapter shows how to:

- Set DTAM Plus DIP Switches
- Connect the DTAM Plus to an SLC Controller
- Run the application

DTAM Plus DIP Switch Settings

To run the application with an SLC 500, set the DTAM Plus DIP switches as shown in Figure 8.1.

Access DIP switches by removing the plug from the access hole on the back of the DTAM Plus.

Figure 8.1
Typical DIP Switch Settings for SLC Operation

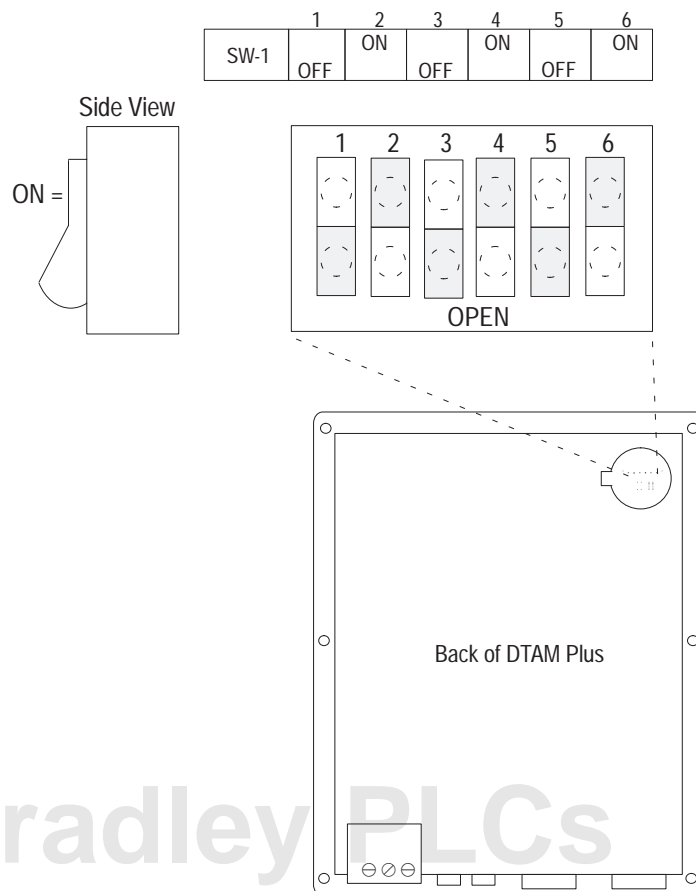

SLC 500 Connections

Connect the DTAM Plus to the SLC 500 using this cable:

- DH-485 Network Interface Cable (Catalog No. 2707-NC1)

Figure 8.2
SLC Cable Connection

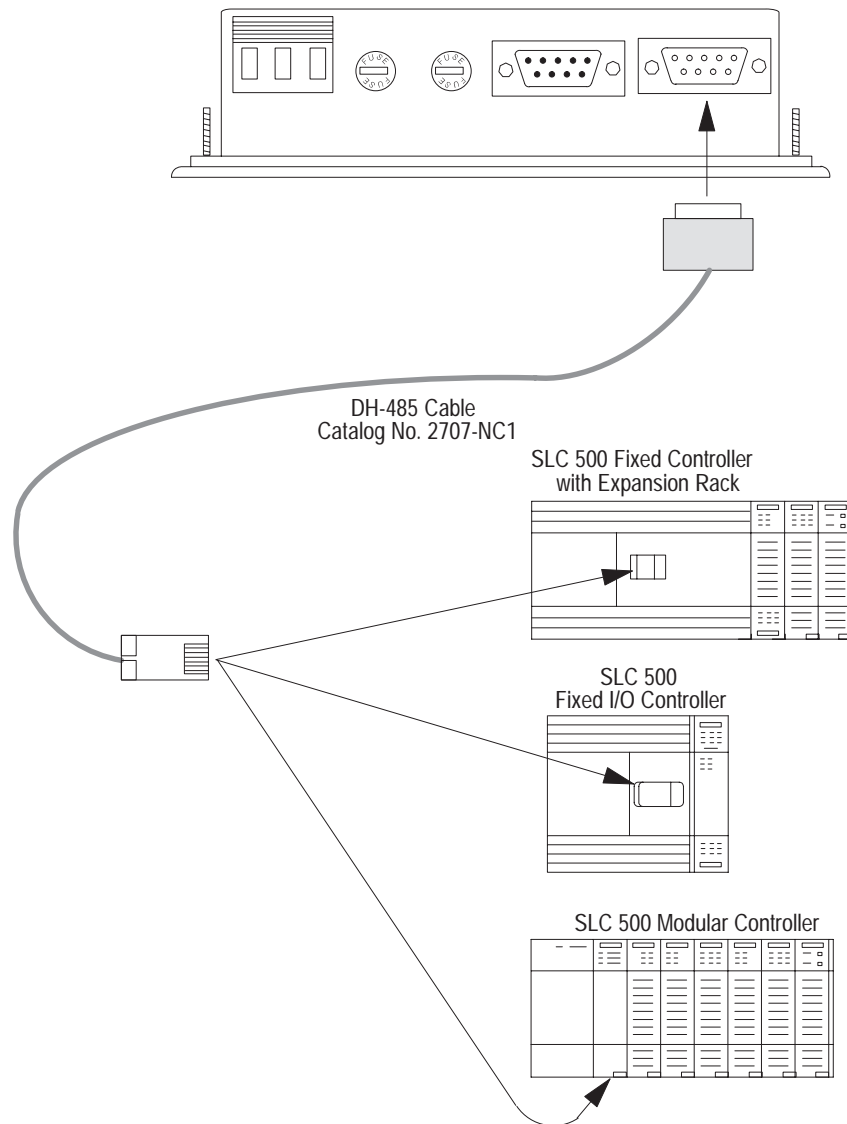

Running the Application

You are now ready to run the sample application.

1. Cycle power to the DTAM Plus to activate the new DIP switch settings.
2. The DTAM Plus displays a series of diagnostic tests, enters run mode, loads the application and then displays the Main Menu of the application.

```

1 Pump Application
2 Tank 1 Parameters
3 Batch Recipes
4 Alarm Demo
    
```

3. Press the [1] key on the DTAM Plus.

A Bar Graph display appears showing the RPM of the pump. The Bar Graph and data display should change as the data in the SLC register T4:11.2 changes.

```

East Main Pump Speed
1276 RPM
|||||||
0 |           | 2000
    
```

4. Press the [NEXT] or [PREV] key to display the Main Menu.
5. Press [2] to access the Sub-Menu.

```

1 Tank Temp Desired
2 Tank Level
3 Mixer Status
    
```

6. Press [1] to enter a new tank temperature.

```

Enter Desired Temp
Actual:150 Deg. C.
Valid Range:140-170
Desired:_
    
```

7. Enter a value of **200** and press the [←] key.

An Input Error appears because the value is out of the 140–170 range.

```

** Input Error **
LOW LIM      HIGH LIM
   140        170
Presss "Y" to Reenter
    
```

8. Press **Y**. You are prompted to enter a new temperature.
9. Enter **150** and press [←]. You return to the Main Menu.

```

1 Pump Application
2 Tank 1 Parameters
3 Batch Recipes
4 Alarm Demo
    
```

10. Press the [2] key to access the Sub-Menu.
11. Press [2] again to display the tank level parameters.

```

Tank Level
 33 Gallons
10% Full
Press Next
    
```

Running the Application

12. Press the [NEXT] key to return to the Main Menu.
13. Press [2] to select the Sub-Menu again.
14. Press [3] to display the mixer status.

```
^ Mixer Status ^  
Mixer is ON
```

15. Press [NEXT] to return to the Main Menu.
16. Press [3]. You are prompted to enter an access code.

```
*RESTRICTED ACCESS*  
ENTER CODE  
:
```

17. Enter **1234** and press [←] key.
The DTAM Plus validates the password and then displays the current register values.

```
PRE: T4:30.PRE 100  
      T4:31.PRE 500  
      T4:32.PRE 300  
Press Next
```

18. Press [NEXT] to display the Recipe Screen.

```
Download Batch Times  
for Chocolate Chip  
  
Press "Y" to Execute
```

19. Press [Y] to download the recipe with the new values that display.

```
NEW: T4:30.PRE 5  
      T4:31.PRE 15  
      T4:32.PRE 25  
Press Next
```

20. Press [NEXT] to return to the Main Menu.
21. Press [4] to display the Alarm Screen.

```
Enter 60 to  
simulate an alarm  
Advisor: 0  
Data Entry:
```

22. Enter **60** and press the [←] key to simulate an alarm.
The alarm LED flashes and the alarm message appears.

```
Mixer OL is Tripped  
03:2 Nov 08 92  
  
PRESS "Y" TO CLEAR
```

23. Press [Y] to return clear the message and return to the Main Menu.



Rockwell Automation helps its customers receive a superior return on their investment by bringing together leading brands in industrial automation, creating a broad spectrum of easy-to-integrate products. These are supported by local technical resources available worldwide, a global network of system solutions providers, and the advanced technology resources of Rockwell.



Worldwide representation.

Argentina • Australia • Austria • Bahrain • Belgium • Bolivia • Brazil • Bulgaria • Canada • Chile • China, People's Republic of • Colombia • Costa Rica • Croatia • Cyprus • Czech Republic • Denmark • Dominican Republic • Ecuador • Egypt • El Salvador • Finland • France • Germany • Ghana • Greece • Guatemala • Honduras • Hong Kong • Hungary • Iceland • India • Indonesia • Iran • Ireland • Israel • Italy • Jamaica • Japan • Jordan • Korea • Kuwait • Lebanon • Macau • Malaysia • Malta • Mexico • Morocco • The Netherlands • New Zealand • Nigeria • Norway • Oman • Pakistan • Panama • Peru • Philippines • Poland • Portugal • Puerto Rico • Qatar • Romania • Russia • Saudi Arabia • Singapore • Slovakia • Slovenia • South Africa, Republic of • Spain • Sweden • Switzerland • Taiwan • Thailand • Trinidad • Tunisia • Turkey • United Arab Emirates • United Kingdom • United States • Uruguay • Venezuela

Rockwell Automation Headquarters, 1201 South Second Street, Milwaukee, WI 53204-2496 USA, Tel: (1) 414 382-2000 Fax: (1) 414 382-4444

Rockwell Automation European Headquarters, Avenue Hermann Debroux, 46, 1160 Brussels, Belgium, Tel: (32) 2 663 06 00, Fax: (32) 2 663 06 40

Rockwell Automation Asia Pacific Headquarters, 27/F Citicorp Centre, 18 Whitfield Road, Causeway Bay, Hong Kong, Tel: (852) 2887 4788, Fax: (852) 2508 1846

World Wide Web: <http://www.ab.com>

Allen-Bradley PLCs